



Café Racer



SANREMO
COFFEE MACHINES

Born to run

*The maximum result in the cup,
one coffee after another*

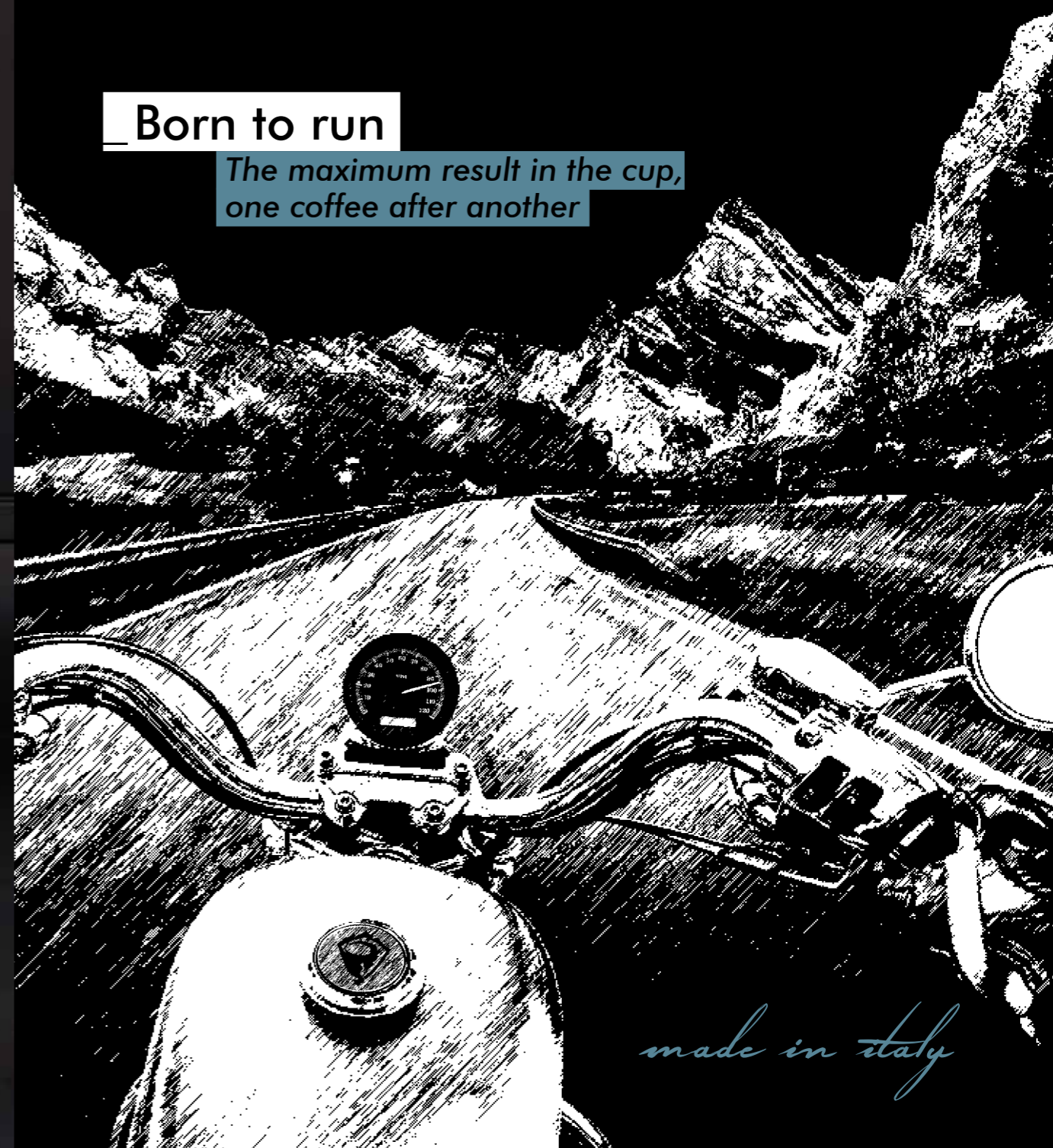

made in italy

SANREMO

COFFEE MACHINES

Take a ride,
explore its essence



ENERGY SAVING SYSTEM
Insulation and smart energy management to save up to 30% of energy



VOLUMETRIC PUMP PERFORMANCE
The unique 79.3 US gal - 300 l/h pump guarantees constant pressure in all conditions of machine use

HIGH RESOLUTION VOLUMETRICS
Deliver greater accuracy and precise programmable dose settings



STEAM PERFORMANCE
Silky milk at high capacity



EASY SERVICE
Fast access to the internal parts for rapid and simple technical service



EVERYTHING UNDER CONTROL
System digital display to provide visibility of all working parameters

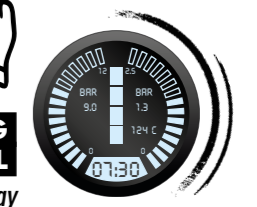

HEART OF STEEL
For maximum thermal stability:
• Groups in AISI 316L, weight 17.6 lb / 8 kg each
• Portafilters AISI 316L
• Boilers AISI 316



SOFT PRE-INFUSION
Flowactive System: for precise control of the water flow and pre-infusion time

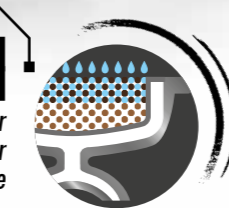



ADJUSTABLE WORK SURFACE
Innovative Sanremo "All in one" suspension system that allows cups of different shapes and heights (adjustable from 3.35 to 5.90 inches / from 85 to 150 mm)



















Characteristics

 **Café Racer, born to run.**
Link to the website.

-  **AISI 316L STEEL GROUPS WITH 17.6 lb / 8 kg PURE STEEL**
Exclusive Sanremo design ensure exceptional thermal stability and maximum resistance to oxidation and lime scale.
-  **AISI 316L STAINLESS STEEL PORTAFILTER WITH "COMPETITION FILTER"**
Exclusive Sanremo design, with shape and volume designed to capture the best coffee aromas and fragrances.
-  **AISI 316L STAINLESS STEEL FREE MOTION STEAM TAPS**
Flexible control system for producing and dispensing steam.

-  **AISI 316L STAINLESS STEEL STEAM WAND "COOL TOUCH"**
Anti-scald wands even in conditions of prolonged use, fitted with "Latte Art" high-performance steam terminals.
-  **PROGRAMMABLE ELECTRONIC PRE-INFUSION**
Allows control with 0.1 second tolerance of the flow of water that wets the coffee bed, with programming of 4 different profiles for each group.
-  **INDEPENDENT ADJUSTMENT OF THE PID INFUSION WATER TEMPERATURE**
Precision setting (gradient $\pm 0.5^\circ\text{C}$ with measured constancy lower than 0.2°C).

-  **SYSTEM DISPLAY**
Visibility of all the machine functions: temperatures, pressures and levels.
-  **COFFEE UNIT SINGLE DISPLAY**
Control of all coffee extraction parameters.
-  **MIXED INFUSION HOT WATER FOR TEA AND HERBAL TEAS**
Instantaneous mixing of fresh water and steam for a better chemical and organoleptic quality.

-  **HIGH PRESSURE VOLUMETRIC PUMP 79.3 US gal - 300 l/h *****
The unique pump guarantees constant pressure in all conditions of machine use (prolonged and simultaneous activation of several functions and units).
 -  **HIGH RESOLUTION VOLUMETRICS**
Deliver greater accuracy and precise programmable dose settings.
 -  **STEAM CONTROL ADJUSTABLE ELECTRONIC PRESSURE SWITCH**
Sensor with 0.02 bar precision that allows the chosen pressure and steam in the boiler to be kept constant in all conditions of use.
 -  **PROGRAMMABLE CUP-HEATER TEMPERATURE**
Allows the cups to be kept at the optimum temperature in the most different climatic conditions.
 -  **ADJUSTABLE HEIGHT WORK SURFACE**
Innovative Sanremo "All in one" suspension system that allows the use of cups and glasses of different shapes and heights.
 -  **LED LIGHTING OF THE WORK SURFACE**
Allows efficient working in any condition of environmental lighting.
 -  **AUTO-DIAGNOSIS, STATISTICAL DATA, SCHEDULED MAINTENANCE**
Maintenance can be scheduled according to litres or number of coffees dispensed.
 -  **AUTO-ON, AUTO-OFF AND DAY-OFF FUNCTION**
Programmable on-off timer for each day and/or daily timetables.
 -  **PROFESSIONAL CLEANING CYCLE**
Guided procedure for cleaning the coffee units.
 -  **BOILER WATER REGENERATION**
Ensures resetting of the optimum chemical characteristics of the water and correct mineralisation.
- Optional**
-  * **NAKED PORTAFILTERS**
 -  ** **HIGH POWER STEAM SPOUTS** (quantity production)
 -  *** **EXTERNAL VOLUMETRIC PUMP**

Café Racer

Models

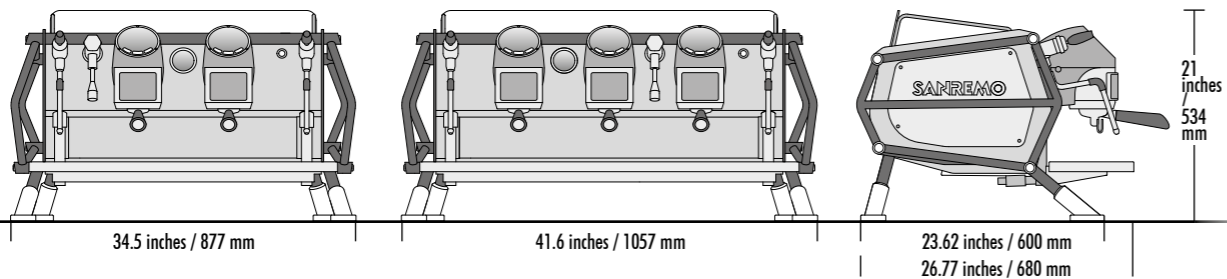

- 2 group CR**
- 2 steam taps
 - 1 water tap
 - 1 one-cup portafilters
 - 2 two-cup portafilters

- 3 group CR**
- 2 steam taps
 - 1 water tap
 - 1 one-cup portafilters
 - 3 two-cup portafilters



MULTIBOILER SYSTEM
Sanremo Café Racer multiboiler system ensures a new level of thermal precision thanks to the 4 points of temperature PID control

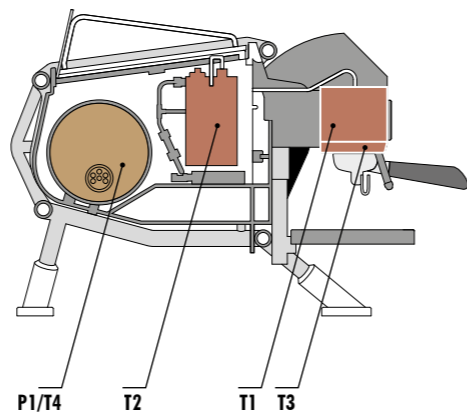

Technical data		2 group	3 group
voltage	V	230/240 1N	380/415 3N
power input	kW	7.03	8.35
steam boiler capacity	US gal / lt	2.11 / 8	2.64 / 10
services boiler resistance power	kW	3.85	3.85
external pump power	kW	0.165	0.165
preheating boiler capacity	US gal / lt	0.264 / 1.0	0.396 / 1.5
preheating boiler resistance power	kW	1.0	1.5
cup-heater power	kW	0.16	0.2
units boiler capacity	US gal / lt	0.264 / 1.0	0.396 / 1.5
units boiler resistance power	kW	1.6	2.4
net weight	lb / kg	214 / 97	265 / 120
gross weight (with shipping crate)	lb / kg	267 / 148	377 / 171



NAKED

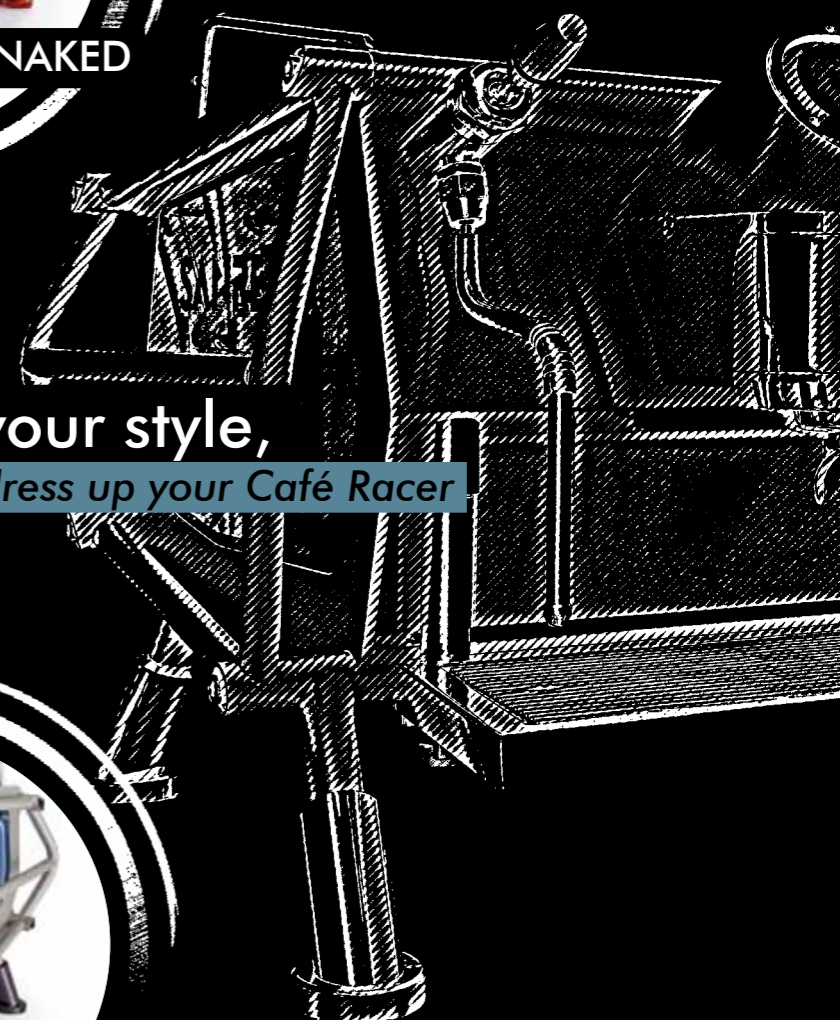

Choose your style,
dress up your Café Racer



FREEDOM



CUSTOM



Built for free spirits

Sometimes designs come to be to achieve a precise objective; other times to make a dream come true; or to follow an ambition.

But this is our story of a coffee machine **conceived in absolute freedom**. No hurry, no restraints, no obligations: except to guarantee impeccable performance to baristas all over the world.

Hence the precise and accurate intuition: to enclose the best of Sanremo technology in a sturdy and stylish chassis: like a motorcycle chassis of the legendary café racer.



From the idea, to the design, to the Sanremo R&D team, to SWAT (*Sanremo World Academy Team*): the project has gone around the world a couple of times. It has been shared with the best operators in the industry and it has become a reality. Café Racer by Sanremo is a powerful and reliable machine, easy-to-handle, versatile and stylish.

A unique, high performance coffee machine, **ready to be desired by all coffee professionals.**





NAKED
look into the soul



With its unmistakable transparent sides, the **Naked Café Racer** allows you to see its powerful heart of pure stainless steel.

The chassis is a sturdy frame with a functional design, supporting and enhancing the essence of the coffee machine.

The Naked Café Racer is available in 2 finishes: black and steel. 
Both available with some components in black or red. ●●

✓ **Naked Black** 
Black ●

✓ **Naked Black** 
Red ●





✓ **Naked Steel** 
Black ●

✓ **Naked Steel** 
Red ●





✓ **Freedom Black** 
 Black | P1 | P2 | P3 | P4 

✓ **Freedom Steel** 
 Black | P1 | P2 | P3 | P4 





FREEDOM

options to fit any character



The **Freedom Café Racer** has 4 coloured side panels available that are enhanced with the rear-lit logo. The classic logo design is inspired by *café racer* motorcycles. A tradition rich in stories, emanating character, style and personality.

The machines are available in versions with a black or steel chassis,   plus an exclusive red finish on some components. ●●



✓ **Freedom Black** 
 Red | P4 

✓ **Freedom Steel** 
 Red | P4 





CUSTOM
welcome free spirits



Step into the garage: where you can have fun outfitting **your Café Racer**. Our R&D team is at your disposal to personalize the finishes that represent you best.

It will be love at first sight.

For example:

- . The **Renegade Café Racer**, with leather sides, a green chassis, bronze finishes and olive wood portafilter handles.
- . The **Dolomiti Café Racer**, completely black edition with black leather sides.



Pre-infusion made to measure

easily navigate the grouphead display

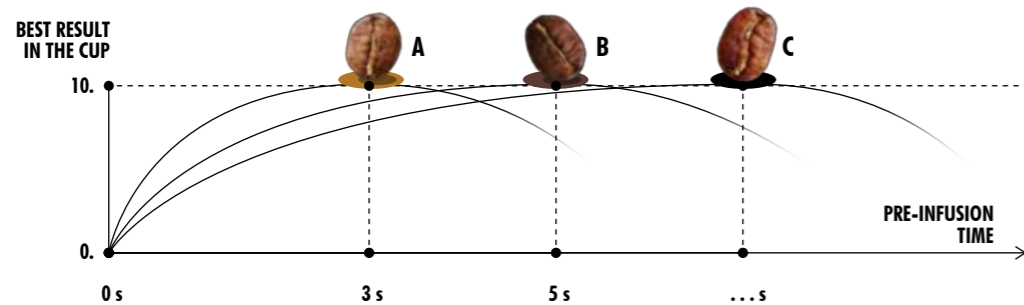

Examples of different coffee types:

- BLEND / A
- BLEND / B
- SINGLE ORIGIN / C

Every single origin or coffee blend has different requirements. For a perfect and homogeneous extraction of coffee solubles, it is fundamental to be able to control the elements of pre-infusion.

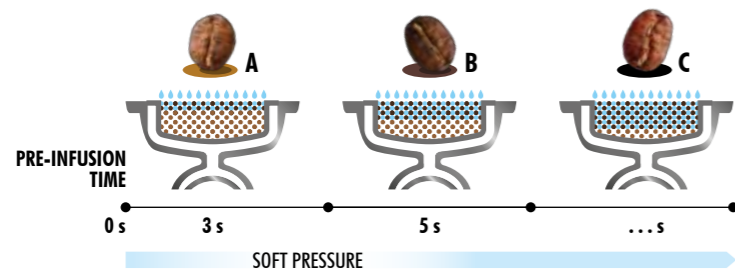

Pre-infusion is the first phase of espresso brewing. Its primary function is to saturate and prepare the coffee bed for optimal extraction. Pre-infusion also allows uniform delivery and aids in preventing channeling.

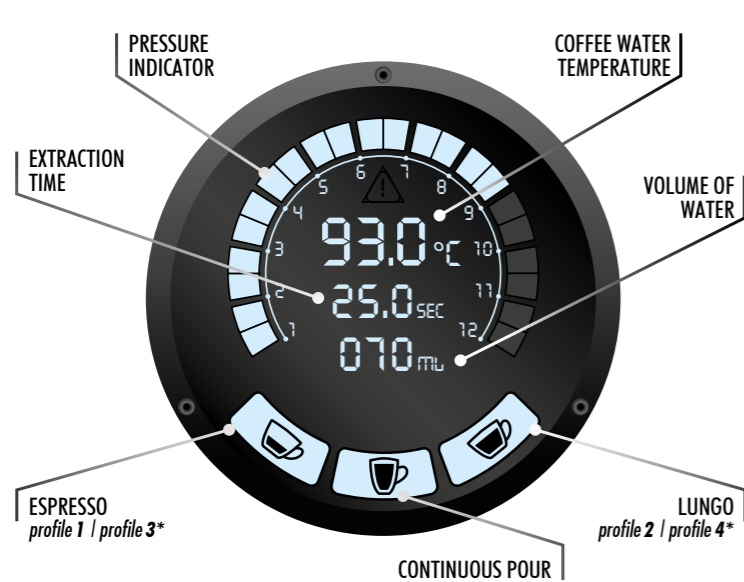

Through the display you can easily program each group for:

- pre-infusion time
- volume of water for extraction
- temperature

For each group you can save 4 different profiles, as well as the continuous dispensing function.

STANDARD SELECTION
> two profiles

* DOUBLE PRESS
> four profiles



STAND-BY



PRE-INFUSION



INFUSION

Everything under control

discover the functions of the digital system display



A look is all it takes: pressure, temperature and water levels are constantly monitored by high-precision electronic sensors, which immediately show real-time values and volumes with absolute reliability.

The display is also a handy programming interface for the maintenance technician.

The display allows the barista to:

- check and program the pressure, temperature and water levels
- collect statistics of the number of coffees, water dispensed, water consumed
- program days and times for switching on and off
- receive warnings for cleaning, washing and component malfunctions
- schedule maintenance
- carry out auto-diagnosis

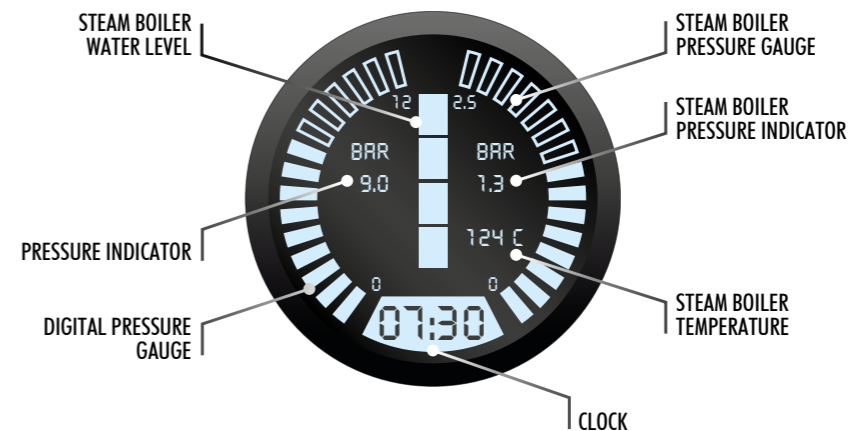

Foam with an artist's touch

high-performance steam function



Use the best Sanremo technology, with impeccable performance, to give free rein to your creativity:

- dedicated steam boiler
- free motion steam taps
- cool-touch steam wand
- high capacity and fast recovery





_ Enjoy your ride

For more information about our
coffee machines please contact us
at export@sanremomachines.com



SANREMO
COFFEE MACHINES

SANREMO coffee machines s.r.l.
Via Giacomo Bortolan 52
31050 Vascon di Carbonera [TV] – ITALY
T +39 0422 448900
F +39 0422 448935
www.sanremomachines.com