

**BROOD**<sup>TM</sup>

**DRNX BY BROOD**  
MANUAL

SAFETY REGULATIONS	3
GENERAL INFORMATION	4
COMPONENTS	5
INSTALLATION	6
OPERATION	7
ADJUSTABLE SETTINGS	8
CARE	9
TROUBLESHOOTING	10
FAQ	12
WARRANTY	13
DECOMMISSIONING	14
CONTACT	15

**NEVER ALLOW WATER TO COME INTO CONTACT WITH ANY OF THE ELECTRICAL PARTS OF DRNX: THERE IS A DANGER OF CREATING A SHORT CIRCUIT.**

## **INTENDED USE**

DRNX is intended to be used in cafes, restaurants, and pantries. It dispenses liquid from any non-pressurized container by drawing liquid, infusing it with atmospheric nitrogen and chilling it to 2°C. Do not liquids that are above room temperature or that are unfiltered. It must only be operated by a trained person. The appliance is not to be used by persons (including children) with reduced physical, mental or sensory abilities or with scarce experience and/or expertise, unless they are supervised by a person responsible for their safety, or they are instructed by this person on how to properly use DRNX.

## **POWER SUPPLY**

DRNX must be connected to the power supply in accordance with its specifications. Only connect it with the specified supply voltage.

## **POWER CORD**

Never use DRNX if the power cord is defective. Report any defects in the cord and/or plug to the service provider immediately. Do not pass the power cord around corners, over sharp edges or over hot objects and keep it away from oil. Do not use the power cord to carry or pull it. Do not pull out the plug by the power cord nor touch it with wet hands. Do not let the power cord hang freely from tables or shelves.

## **FOR THE SAFETY OF OTHERS**

Ensure that children cannot play with DRNX and/or the packaging materials. Observe the warning and safety instructions on the electrical components and in this manual. Improper use of DRNX such as opening it during operation, incorrectly operating it, or not following standard guidelines for operating electrical equipment may lead to injury.

## **FIRE SAFETY PRECAUTIONS**

In case of fire, use carbon dioxide (CO<sub>2</sub>) extinguishers. Do not use water or dry powder extinguishers.

## **SUITABLE LOCATION FOR OPERATION AND MAINTENANCE**

DRNX should be installed in accordance with the safety regulations in force at the time of installation. Operate it in an environment between 13°C and 32°C. Make sure it is a dust-free environment. Avoid placing open flames and/or incandescent objects near it to avoid melting or other damage to the dispenser housing. If the dispenser has been exposed to such conditions, alert the service provider who will carry out a safety check.

## **STORING DRNX**

If DRNX is to remain inactive for a long time, turn it off and unplug it. Store it in a dry place, out of reach of children. Make sure the storage area is between 13°C and 40°C. Keep it protected from dust and dirt.

# SAFETY REGULATIONS

## GENERAL INFORMATION

### REPAIRS / MAINTENANCE

In case of failure, problems or a suspected fault resulting from a fall, immediately remove the plug from the power socket and alert the service provider or specialized technician. Never attempt to operate it if it is faulty. Please report any fault to your service provider. Only the service provider and/or technician may carry out servicing operations and repairs on DRNX, unless otherwise informed. Any repair of the dispenser must be done only when it is switched off and it is ascertained that there is no electric current. All spare parts must be obtained from your service provider. Follow the service and maintenance instructions in this operation manual.

### USE

DRNX pulls any filtered liquid from an unpressurized container. It chills the liquid to 2°C and infuses it with atmospheric nitrogen.

### VISCOSITY OF LIQUID

Ensure that your beverage has been filtered in order not to clog the pre-filter or if that has been bypassed, not to clog the machine. Thick liquids risk slowing down the liquid pump inside. DRNX comes with a pre-filter that is already fitted onto the beverage tube. If the pre-filter is not attached, you can risk damaging components inside.

### BEVERAGE CONTAINER

Any non-pressurized container can be used depending on what is required. We recommend using the designated BROOD container (sold separately).

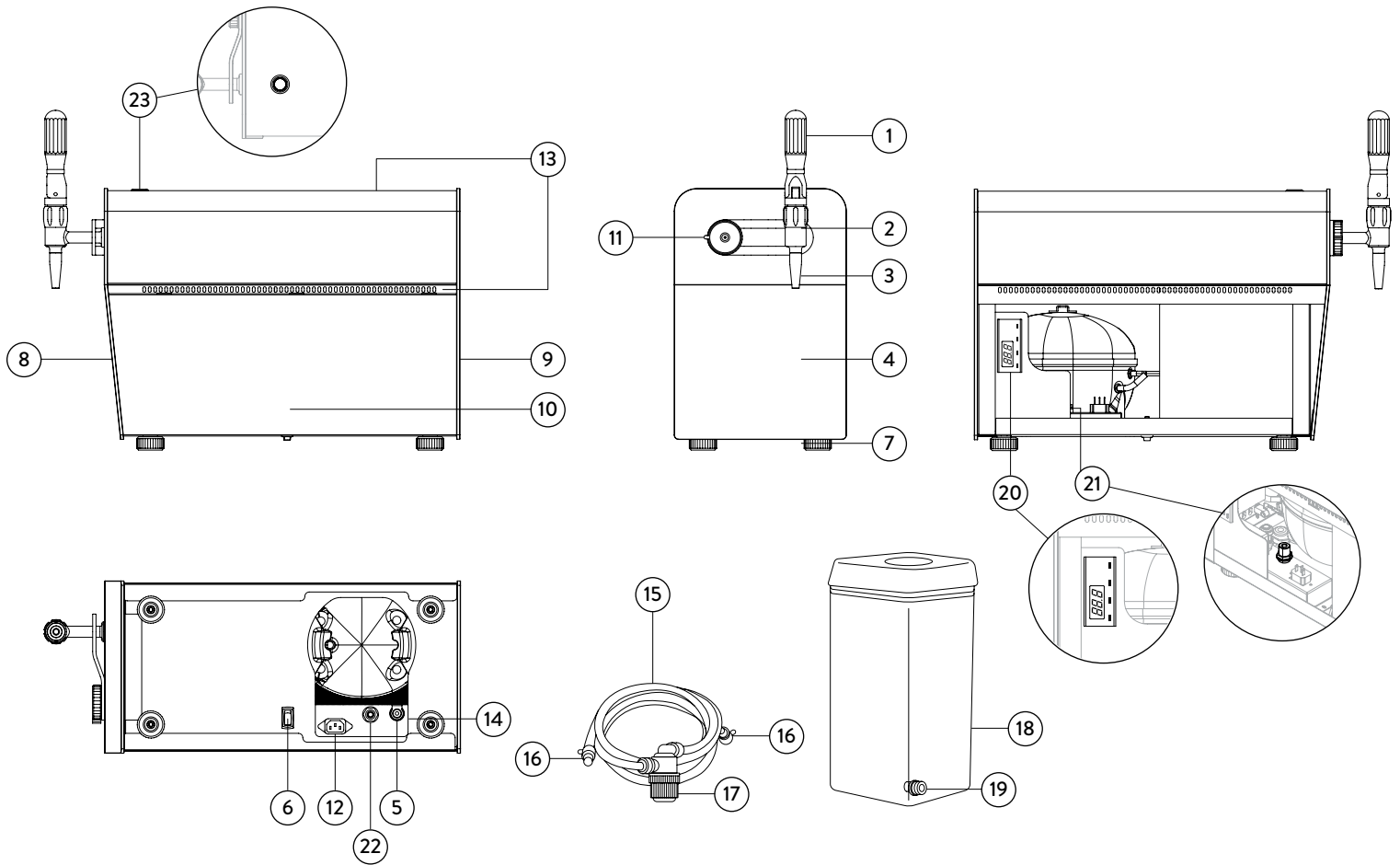

- 1 – Tap Handle
- 2 – Tap Body
- 3 – Nozzle
- 4 – Exterior
- 5 – Inlet Connector
- 6 – Main ON/OFF Switch
- 7 – Legs
- 8 – Forward Plate
- 9 – Rear Plate
- 10 – Side Panel(s)
- 11 – Infuser Dial
- 12 – Power Plug
- 13 – Vents/Exhaust
- 14 – Control Panel
- 15 – Beverage Tube
- 16 – Elbow Connectors
- 17 – Pre-Filter
- 18 – BROOD Beverage Container
- 19 – Inlet for Container
- 20 – Thermostat
- 21 – Calibration Knob
- 22 – Ventilation Valve
- 23 – Power ON/OFF

## SPECIFICATIONS

Width: 9.75in	Power Supply: 100-120V/60Hz; 200-240V/50Hz
Height: 14.75in	Nominal Power: 334W
Depth: 18.25in	
Weight: 73lbs	
Dispensing Capacity: 1.5L/min (0.4gpm)	
Coffee Temp at Tap: 2°C (36°F)	

## SETUP

1. **Install on a clean and dry surface.**  
Allow no less than 5 centimetres of space from all sides.
2. **Assemble the tap handle.**
3. **Plug the power cord into an electrical outlet.**  
**Connect the beverage tube to DRNX by pushing the elbow fitting into the connection underneath the machine.**  
Tilt the machine slightly if you need to. If you need to release the beverage tube, push the metal spring next to the connection underneath.
4. **Connect the beverage tube to the pre-filter.**  
Make sure the arrow at the base of the pre-filter is pointing in the direction of the flow.

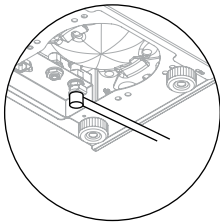

**WARNING: If you do not use the pre-filter, the following problem may occur:**

Blockage in the machine due to large coffee particles.  
Make sure all tubes are pushed firmly in place.

## CONNECT TO CONTAINER

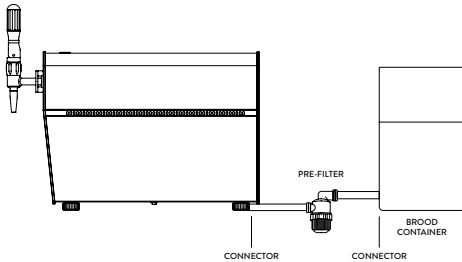

**Connecting to the designated BROOD container.**

1. **Pour your beverage into the designated container.**  
Close the lid and push the seal.
2. **Push one of the elbow fittings into the connector at the bottom of the container. And push the other fitting into the connector at the bottom of the machine.**
3. **Make sure the arrow at the base of the pre-filter is pointing in the direction of the flow.**

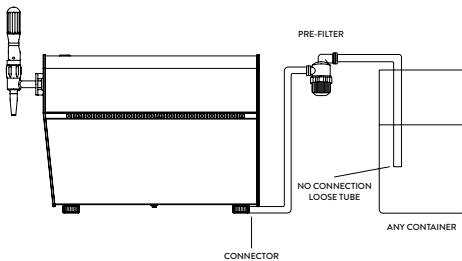

**Connecting to any container.**

1. **Pour your beverage in any container.**
2. **Push the elbow fitting into the connector at the bottom of the machine.**
3. **Drop the loose end of your beverage tube into the container containing your beverage.**
4. **Make sure the arrow at the base of the pre-filter is pointing in the direction of the flow.**

DRNX will pull from any container. If using a keg, then attach your beverage tube to a keg coupler. If using a bag-in box, then attach your beverage tube to a bag-in-box adaptor.



**WARNING: Liquid containing solid matter cannot be used.**

**WARNING: Never run hot liquid above 30 °C (86 °F) through DRNX.**

## STEPS

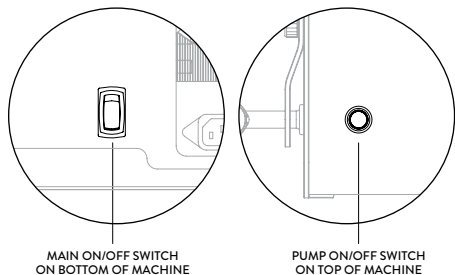

1. Switch on the main ON/OFF button at the bottom of the machine.  
There will be a red light when the switch is on.
2. Switch on the pump ON/OFF button located at the top of the machine.  
 There will be a red light when the switch is on.  
 The pump will automatically turn off if it runs dry for one minute.  
 This will notify the operator that the beverage container is empty.  
 Simply switch the pump off, then on again to reset.
3. Place your cup beneath the stout at an angle.
4. To pour a STILL beverage, turn the infuser dial clockwise.  
To pour a NITRO beverage, turn the infuser dial counter-clockwise.

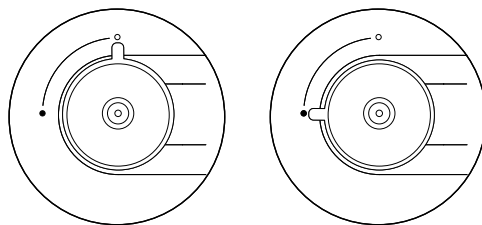

Please note, if the last pour was nitro cold brew and the operator wants the next pour to be still cold brew, there will be less than 10 mL (0.34 oz) of nitro cold brew in the tap that will come out. Every subsequent still cold brew pour will come out fully still, until the next nitro cold brew pour.

5. Return the tap to the start position when you have completed the pour.



Make sure the pre-filter adapter is installed in the beverage tube.  
 Ensure that the coffee is filtered with a fineness of at least 100  $\mu\text{m}$  (microns).  
 Not using the pre-filter risks damaging the internal components of DRNX.

## TEMPERATURE CONTROL

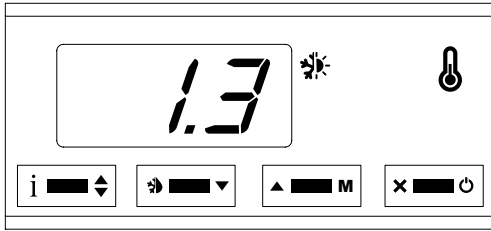

**i** [button icon] Info / Setpoint button.

**➔** [button icon] Manual defrost / Decrease button.

**▲** [button icon] Increase / Manual Activation button.

**x** [button icon] Exit / Stand-by button.

## MODIFICATION OF DESIRED TEMPERATURE VALUE

Press button **i** [button icon] for at least half second, to display the setpoint value.

By keeping button **i** [button icon] pressed, use button **▲** or **▼** to set the desired value.

When button **i** [button icon] is released, the new value is stored.

**If the operator sets the temperature at freezing, it runs the risk of freezing the Cold Brew. If this happens, turn off the fridge as described in step 2. Keep off for 2 hours.**

## NITROGEN CALIBRATION

Locate the infuser dial at the front of the machine. Turn the dial clockwise towards the 12 o'clock position to pour a still drink. Turn the dial counter-clockwise towards the 9 o'clock position to pour a nitrogenated drink.

**If the level of nitrogen infusion is too high at the maximum (9 o'clock) position, then follow the steps below to decrease the level of nitrogen infusion. This is a one-time calibration process to adjust the amount of infusion at the maximum position only.**

- 1. Locate and remove the four screws in the back panel.**
- 2. Locate and remove the two screws underneath the machine on the left side.**  
Only tilt the machine slightly when unscrewing from the bottom. Tilting the machine too much may damage the compressor. The best practice is to bring the machine close to an edge to gain access to the two screws underneath.
- 3. Pull the bottom of the side panel outward and slide it back to release it.**
- 4. Locate the calibration knob. Turning it clockwise will decrease the amount of nitro.**
- 5. Return the side panel and screw it securely from underneath the machine.**
- 6. Return the back panel and screw it securely.**



## CLEAN & MAINTAIN

 Follow the cleaning procedures below as it is essential to both extend the life of the DRNX, and to achieve the desired flavor of cold brew.

 DRNX needs to be flushed with water every 24 hours. In addition, it must be cleaned every week as described in the steps below.

## DAILY FLUSH

1. Replace the cold brew in the container with clean water. Pull the tap downwards and keep it in this position until all the cold brew is flushed out of DRNX and clean water begins to come out from the tap. Return the tap to the idle position and switch off DRNX.

## WEEKLY CLEANSE

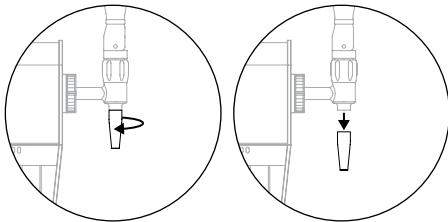

1. Repeat the steps described in the above section titled “Daily Flush.”
2. **Unscrew the nozzle from the tap by turning it counter-clockwise. Please wash the nozzle with clean water.**

After washing, please reassemble it onto the tap.

3. **Unscrew the cover of the pre-filter by turning it counter-clockwise. Remove the stainless steel mesh and wash with clean water.**

Make sure the stainless steel mesh is not clogged.

4. **After this procedure is complete, switch on DRNX from the main power source underneath.**

5. **Switch on the pump ON/OFF button.**

6. **Prepare the cleaning solution.**

Dissolve any espresso cleaning detergent in water to create a cleaning solution. Follow the directions outlined as per the cleaning detergent.

7. **Pull the tap downward to run the solution through DRNX.**

Keep pouring until all the solution has been flushed through the dispenser.

8. **Fill the container with water again and pull the tap downwards to flush DRNX with water. Keep pouring until all the water has emptied.**

Connect a 5/16” tube to the ventilation port (underneath the machine) and drop the loose end of the tube into the container of water.

Observe water being sucked into the ventilation port.

Only use clean water and NOT the cleaning solution for this step.

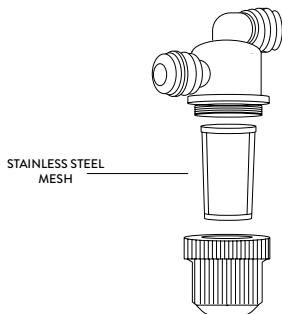

**BROOD recommends the following cleaning detergent: 1-2-COLD BREW Cleaner by Urnex**

## QUICK SOLUTIONS

There is too much nitro	The calibration knob is not set correctly.	Follow steps in to decrease the level of infusion outlined in section “Nitrogen Calibration”
There is no nitro even though it's set to maximum.	There is a block in the spout	Unscrew the spout and check to see if there is any sediment. Remove the components inside the spout and wash thoroughly.
Too many large bubbles	Beverage tube is not pushed in firmly.	Release the elbow fitting by pushing the spring underneath DRNX and reconnect. If using a keg or a Bag-in-Box make sure that the coupler is secured firmly.
Product is not cold enough.	The temperature setting is too high.	Check to see if the main switch underneath the machine is on. Follow the instructions in the manual to change the temperature setting.
	The cold brew in the container is too hot.	The variance between the cold brew in your container and at the tap is 20°C. This means if your cold brew is 22°C (room temperature), then the nitro cold brew at the tap will be 2°C.
	Pause for a moment between pours.	If pouring more than 1.5 litres (48oz.) continuously and without stopping, then it might be necessary to pause for a few minutes for the exhaust fan to turn off until pouring a subsequent drink.

## QUICK SOLUTIONS

DRNX is not pouring cold brew.	The pre-filter is clogged.	Unscrew the cap and check if the pre-filter is clogged. Remove any sediment and then re-attach.
	There is no electrical power connected to the machine	Check to see if the main switch underneath DRNX is on. Then check to see if the pump switch on the top of the machine is on. If either one is off, please switch them on. If the pump switch is flashing, switch it off then on to reset the pump.
	The pump ON/OFF switch needs to be reset.	When your container is empty, the pump turns off and the ON/OFF switch flashes red. Switch it off then on to reset the pump.
	The cold brew in the machine is frozen. If the cold brew in the external container is close to 0°C, then the dispenser might freeze the cold brew in the cooling block.	Disconnect the machine from its power supply. Wait 2 hours before trying to pour again.
	If DRNX is used without a pre-filter in the beverage tube, coffee particles may get into the pump and damage or block valves. Liquid may not be drawn in anymore.	The machine and the pump must be flushed with tap water.
		<ol style="list-style-type: none"> <li>1. Unscrew the tap nozzle.</li> <li>2. Connect the beverage tube to the inlet connector.</li> <li>3. Disconnect the pre-filter.</li> <li>4. Switch the machine off.</li> <li>5. Attach a tube from a water main to the tap in order to reverse flush the machine with water.</li> <li>6. Re-attempt normal operation to check if the blockage is gone.</li> </ol>
The flow of the nitro pour is weak	The foot of DRNX is on top of the beverage tube	Lift the machine slightly and release the tube from underneath the foot.
	There is a kink in the beverage tube	Make sure the beverage tube underneath the machine stretches towards the back of the machine. This means there can be no possible kink underneath the machine.

**Q. I JUST RECEIVED MY DRNX, HOW DO I SET IT UP?**

A. Please follow the instruction manual that comes with DRNX. It is easy to set up!

**Q. WHERE DO I PUT MY COLD BREW COFFEE OR TEA?**

A. DRNX can pull cold brew from any container. DRNX comes with a beverage tube that clips into the dispenser from underneath. The other end is loose so that an operator can drop it into any container. Alternatively, an operator can attach a keg coupler, bag-in-box adaptor, or an elbow fitting to the other end of the beverage tube in order to connect it to a keg, bag in-box, or BROOD container respectively. Please watch our instructional video on our website.

**Q. I AM NOT GETTING ENOUGH CREMA, WHAT SHOULD I DO?**

A. Firstly, pull the tap fully downward (90°) to trigger nitrogen infusion. Pulling it only a little bit will yield still cold brew only. Secondly, rotate the infusion dial towards the 9 o'clock position. Thirdly, the pre-filter might be clogged and in need of cleaning. Check our troubleshooting section.

**Q. I AM GETTING LARGE BUBBLES IN MY NITRO COLD BREW, WHAT SHOULD I DO?**

A. Make sure all the tubes are pushed in firmly and there is no air seepage. Observe if there are any air bubbles flowing through the beverage tube. Air that seeps into the tubes will ultimately come out at the tap in the form of air bubbles. This will also happen if your beverage tube is sucking in air from a loose connection. The quality of the cold brew also has a marked effect on the size of the bubbles in the final head of the drink. The more filtered the cold brew, the smoother the surface of the head.

**Q. MY BEVERAGE IS NOT COLD ENOUGH, HOW DO I MAKE IT COLDER?**

A. Follow the instructions in section "Temperature Control" on page 6 to decrease the temperature.

**Q. DRNX IS NOT POURING COLD BREW, WHAT SHOULD I DO?**

A. There are several reasons why this may happen. All of them are easily remedied. Please follow our troubleshooting guide in this instruction manual.

**Q. WHEN I POUR MANY GLASSES OF NITRO COLD BREW CONTINUOUSLY, THE FOURTH ONE IS SOMETIMES SLIGHTLY LESS CHILLED THAN THE FIRST ONE. WHY IS THAT?**

A. We recommend pouring for 45 seconds which is about 1 litre (32oz.) and then pausing for a few moments until the exhaust fan switches off. This means the cold brew inside the fridge has been chilled to your desired temperature.

**Q. DRNX HAS A SOUND THAT COMES AND GOES, WHY?**

A. This is the sound of the exhaust fan. When this sound is heard it means that the fridge is cooling down to the pre-set temperature. When the sound stops this means that the compressor has also stopped as the desired temperature has been reached.

**Q. I HAVE THE FRIDGE SET AT THE COLDEST POSSIBLE TEMPERATURE, BUT THE BEVERAGE IS NOT COLD ENOUGH, WHY IS THIS?**

A. The variance between the cold brew in your container and at the tap is 22°C. This means if your cold brew is 24°C (room temperature) then the nitro cold brew at the tap will be 2°C. Never use cold brew or any other liquid that is warmer than room temperature.

**Q. DO I NEED TO KEEP A GAP AROUND THE VENTS ON THE TOP OF DRNX?**

A. Yes, never cover the exhaust located on top of the machine. If covered, it may damage the compressor.



**The warranty period is 1 year. Please review our warranty terms and conditions.**

In order for the products to be stable, long lasting, AND covered under this manufacturer's warranty, these requirements must be met:

DRNX is designed to be installed in interior areas with relative humidity levels of 35%-60% and operate at temperatures between (13°C - 32°C). DRNX must be stored at temperature between (13°C - 40°C). Prior to opening original packaging or installation material, ensure that the spaces are enclosed and completely weatherproof, and the building temperature and humidity conditions are consistently maintained at the indicated levels. The product **MUST** be stored in an environmentally controlled space at all times. Do not store the product in direct sunlight.

### **THIS WARRANTY DOES NOT COVER:**

- Any machine NOT distributed by BROOD Refreshments Company Ltd.
- Any machine NOT purchased from an Authorized BROOD Dealer (email us at [hello@drinkbrood.com](mailto:hello@drinkbrood.com) to check for authorized dealers or check our website at [www.drinkbrood.com](http://www.drinkbrood.com)).
- Damage caused by accident, abuse, negligence, or misuse.
- Improper operation or failure to follow instructions contained in the manual.
- Any service or alteration performed by an unauthorized person, company, or association.
- Damage caused by neglecting to clean and/or maintain upkeep of DRNX.
- Damage caused by use of undissolved instant coffee or any other ingredients not allowed in the dispenser.

This warranty is not transferable and applies to the original purchaser only.

The warranty period begins on the delivery date. If our transportation, storage or installation instructions are not followed, any warranty shall lapse. The warranty period is 1 year. The purchaser must inform BROOD Refreshments Company Ltd in writing of any transportation damages without delay, but at the latest within one week of arrival of the equipment. The purchaser must cease any processing or handling of the damaged units. BROOD does not accept any guarantee against defects which are due to improper storage or use of the products. The storage and use of the products presuppose that full knowledge and experience of the technology is taken into account to avoid detrimental effects on the quality and stability. This warranty does not cover damage caused by improper maintenance or by use contrary to our recommendations. There are no implied warranties, representations or conditions, except those required by statute, and they shall not extend beyond the term of the warranty applicable to your purchase.

### **CLEANING IS A CRITICAL PART OF MAINTAINING THE LONGEVITY OF DRNX**

- Prior to installation, use a clean soft cloth that has been dampened to remove dust or other foreign materials from panel surfaces. Dirt and grit should not be allowed to build up as these may scratch the finish during setup.
- Do not apply soap or cleaner directly to panel surfaces. Apply water to cloth and then wipe panel surfaces.
- Do not apply any solvents to panel surfaces, even by transfer from a cleaning cloth.
- Damage from solvents may not be immediately noticeable upon application. Do not use brushes to clean panels or vents as bristles will scratch panel surfaces.
- Daily flushing of DRNX as outlined in the operation manual is required.
- Cleaning DRNX consistently is crucial to the operation and lifespan. Any negligence in daily cleaning and upkeep of DRNX will risk damaging the machine over time. The warranty period is 1 year. Please review our warranty terms and conditions. To make a warranty claim, please email [hello@drinkbrood.com](mailto:hello@drinkbrood.com). For faster service, locate the model type and serial number, and include them in your email.



**To make a warranty claim, please email [hello@drinkbrood.com](mailto:hello@drinkbrood.com). For faster service, locate the model type and serial number, and include them in your email.**

## STORAGE

Before placing DRNX out of service for a period longer than 2 weeks, we recommend the weekly cleanse as per the instructions in the Care section. Store DRNX in a dust-free environment between 13°C and 40°C.

## DISPOSAL

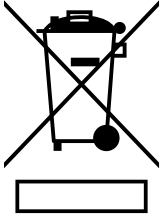

The packing materials can be recycled. Unplug the appliance and the power cord. Deliver the appliance and power cord to a service centre or public waste disposal facility. This product may not be treated as household waste. Instead it shall be handed over to the applicable collection point for the recycling of electrical and electronic equipment. By ensuring this product is disposed of correctly, you will help prevent potential negative consequences for the environment and human health, which could otherwise be caused by inappropriate waste handling of this product. For more detailed information about recycling of this product, please contact your local city office, your household waste disposal service or the shop where you purchased the product.



