



UGEAR'S®

Mechanical models

Mechanical Celesta Механічна Челеста

FRA Célesta mécanique DEU Mechanische Celesta
SPA Celesta Mecánica ITA Celesta Meccanica
JPN メカニカルチェスタ CHI 机械钢片琴 POR Celesta mecânica
POL Czelesta mechaniczna KOR 기계식 셀레스타

Assembly instructions Інструкція зі складання

FRA Notice d'assemblage. DEU Aufbauanleitung.
SPA Instrucciones de montaje. ITA Istruzioni di montaggio.
JPN 組み立て説明書 CHI 装配说明书 POR Instruções de montagem.
POL Instrukcja montażu. KOR 조립 설명서.



MECHANICAL
МЕХАНІЧНИ



NO GLUE CONNECTION
БЕЗ КЛЕЮ



PLYWOOD
З ФАНЕРИ



Find out MORE

Assemble Me.
Let the celestial music play

ENG

Assembly instructions:
Remove model parts from the hanger board as illustrated below. Careful not to break parts. If a part does not remove easily, carefully cut it out with a knife. This model is intended for self-assembly without glue. If you have difficulty installing the axles, try waxing them with a regular candle. All moving parts can also be waxed during assembly to reduce friction when operating the model.

CHI

装配说明
将模型部件按插图示，从胶合板取下。小心不要损坏件。如果取下时候有难度，请用小刀小心的切割连接点。这个产品不需要胶水粘接。如果安装转轴的时候有难度，请用普通的蜡加以润滑。所有的转动部分也需要打蜡润滑。

UKR

Інструкція зі складання:
Витягніть з дошки позначені на схемі деталі. Намагайтеся їх не зламати. Якщо деталь не виймається, надсічіть перемички ножем. Конструкція збирається без клею. У разі виникнення труднощів з протягуванням вісі в отвір, потріть деталь об звичайну свічку. Також можна змастити свічкою всі деталі механізму, що рухаються, щоб зменшити тертя при обертанні.

POR

Instruções de montagem: Remova as peças do modelo da placa de suporte, conforme ilustrado abaixo, tomando cuidado para não quebrar as peças. Se uma peça não sair facilmente, corte-a cuidadosamente com uma faca. Este modelo foi feito para ser montado sem necessidade de usar cola. Se você tiver dificuldade em instalar os eixos, tente adicionar um pouco de cera como a de uma vela comum. Todas as peças móveis também podem ser enceradas durante a montagem para reduzir o atrito ao usar o modelo.

FRA

Notice d'assemblage:
Faites sortir de la planche les pièces comme indiquées sur le schéma. Tâchez de ne pas les casser. Si la pièce ne sort pas, incisez les collages/fixations avec un couteau. La construction est à assembler sans colle. Si il est difficile d'introduire l'axe en bois dans l'orifice, frottez au préalable l'axe ou les pièces contre une bougie. Pour améliorer le glissement, traitez les pièces de frottement mobiles du mécanisme avec une bougie au cours d'assemblage.

POL

Instrukcja montażu:
Delikatnie wyciągaj z deseczki wskazane w schemacie detale, starając się nie połamać elementów. Jeśli detal nie poddaje się, podetnij wiązadła nożem. Konstrukcje składa się bez kleju. Jeśli napotkasz trudności z instalacją drewnianej osi w otwór, potrzyj na początku oś lub detale z woskową świecą. Dla lepszego poślizgu polecano smarowanie ruchomych części mechanizmu zwykłą świecą podczas montażu.

DEU

Aufbauanleitung:
Bitte die in der Zeichnung angegebenen Teile aus der Platte herausnehmen. Versuchen Sie bitte diese nicht zu brechen. Wenn sich ein Teil nicht herausnehmen lässt, schneiden Sie die Stege mit dem Messer leicht an. Das Modell wird ohne Klebstoffe zusammengebaut. Lässt sich eine Achse nur schwer in eine Öffnung einführen, reiben Sie diese mit einer Kerze etwas ein. Für besseres Gleiten schmieren Sie alle beweglichen Teile mit einer Kerze.

KOR

조립 설명:
부품이 손상되지 않도록 주의하여 보드에서 떼어냅니다. 만약 부품이 잘 떨어지지 않으면 연결 부분을 칼로 절단 한 후 떼어내면 쉽게 떼어 낼 수 있습니다. 본 제품은 접착제가 없이 조립이 가능하도록 설계되어 있습니다. 만약 축이 잘 끼워지지 않는 경우 양초를 축에 바른 후 끼워 보세요. 모든 구동 부위는 제품 구동 시 원활한 작동이 가능하도록 조립 과정에서 윤활제(양초)양초를 발라 주세요.

SPA

Instrucciones de montaje:
Saque de la tabla las piezas marcadas en el esquema. Trate de no romperlas. Si una pieza no se saca, haga una incisión. La construcción va sin pegamento. Si tiene dificultades con la instalación del eje de madera en un agujero, frote primero el eje o las piezas contra una vela. Para un mejor deslizamiento, lubrique durante el montaje las piezas móviles del mecanismo con una vela común.

ITA

Istruzioni di montaggio:
Estrarre dal telaio i particolari indicati nello schema. Fare attenzione a non romperli. Se un particolare non si stacca, tagliare delicatamente gli elementi di collegamento con un coltello. L'assieme viene realizzato senza colla. In caso di difficoltà nell'inserimento di un perno in legno, è necessario sfregare il perno o il particolare con un po' di cera. Per uno scorrimento migliore incerare le parti mobili del meccanismo durante l'assemblaggio.

JPN

組み立て説明書:
部品に傷をつけないように注意しながらボードから外してください。部品が外れにくい場合は連結部分をカッターで切ってから外すと外しやすいです。本製品は、接着剤がなくても組み立てができるように設計されています。もしアクスル(駆動部)が、歯車の動きがにぶい場合は、ロウソクをアクスルに塗ってください。全ての駆動部分は製品を動かす時、滑らかに動くように潤滑剤であるロウソクを塗りながら組み立てます。

ENG Warning! UKR Увага! FRA Attention! DEU Achtung! SPA Precaución!
ITA Attenzione! JPN 注意! CHI 注意! POR Atenção! POL Uwaga! KOR 주의!



ENG Do not use a lighted candle! UKR Не підпалювати!
FRA Ne pas brûler! DEU Nicht anzünden!
SPA ¡No encender! ITA Non dare fuoco!
JPN 火のついたロウソクの使用はお止めください。

CHI 请勿点燃，请勿靠近火源！ POR Não use uma vela acesa para este propósito! POL Nie podpalać! KOR 불이 붙은 초를 이용하지 마세요!

ENG Customer support UKR Служба підтримки FRA Service client DEU Kundendienst SPA Servicio al cliente

ITA Servizio di supporto JPN お客様窓口 CHI 客户支持 POR Atendimento ao cliente POL Wsparcie klienta KOR 고객지원

customerservice@ugearsmodels.com



ENG Wax the part with a regular candle (rub with a candle). **UKR** Змастіть деталь звичайною свічкою (потріть об свічку). **FRA** Lubrifiez la pièce avec une bougie ordinaire (frottez contre la bougie). **DEU** Reiben Sie das Teil mit einer einfachen Kerze etwas ein. **SPA** Engrase la pieza con una vela común (frote con una vela). **ITA** Incerare il componente (Sfregare con la cera). **JPN** された部分に潤滑剤として口ソクを塗ってください。 **CHI** 用普通蜡烛涂抹润滑部件 **POR** Encere a peça com uma vela comum (esfregue em uma vela). **POL** Przesmaruj zwykłą świecą. **KOR** 표시된 부분에 윤활을 위해 초를 칠해 주세요.



ENG Sand to remove burrs. **UKR** Видаліть задирки. **FRA** Éliminez les bavures. **DEU** Grate entfernen. **SPA** Quite las rebabas. **ITA** Togliere le bave. **JPN** バリ取りのサンドペーパー **CHI** 磨掉毛刺 **POR** Lixe para remover rebarbas. **POL** Usuń zadziory. **KOR** 거친 부분을 다듬어 주세요.



ENG Pay attention. Check position of the part. **UKR** Зверніть увагу. Перевірте розташування елемента. **FRA** Faites attention. Vérifiez l'adispotion de l'élément. **DEU** Bitte Beachten. Prüfen Sie die Einbaulage des Elementes. **SPA** Atención. Compruebe la situación del elemento. **ITA** Prestare attenzione. Controllare la posizione del componente. **JPN** 方向及び位置に注意して組み立てて下さい。 **CHI** 注意! 检查部件方向和位置 **POR** Preste atenção à posição da peça. **POL** Zwróć uwagę. Sprawdź lokalizację elementu. **KOR** 방향 또는 위치에 주의해서 조립해 주세요.



ENG Check the mechanism for smoothness and accuracy of movement. Operate the mechanism so the parts would seat-in. **UKR** Перевірте механізм на плавність і точність ходу. Розробіть механізм. **FRA** Vérifiez si le mécanisme fonctionne en douceur et avec précision. Faites fonctionner le mécanisme jusqu'à son fonctionnement normal. **DEU** Prüfen sie den Mechanismus bezüglich der Laufruhe und der Genauigkeit des Ganges. Betätigen Sie den Mechanismus mehrmals. **SPA** Verifique la suavidad y precisión del mecanismo. Desarrolle el mecanismo. **ITA** Controllare la scorrevolezza e la precisione del movimento. Far funzionare il meccanismo. **JPN** 駆動部分が滑らかに動くかを確認しながら作業をすすめます。 **CHI** 检查机构的运行平稳度和精确度。调整机构。 **POR** Teste a suavidade e precisão do movimento do mecanismo. Opere o mecanismo para que as peças se encaixem. **POL** Sprawdź płynność i dokładność ruchu mechanizmu. Dopracuj mechanizm. **KOR** 구동 부분의 원활한 작동과 정확한 움직임을 확인하세요.



ENG Cut (rubber-band, thread, etc.). **UKR** Відріжте (гумку, нитку, тощо). **FRA** Couper (ruban élastique, fil, etc.). **DEU** Schneiden (Gummiband, Faden, etc.). **SPA** Cortar (goma elástica, hilo, etc.). **ITA** Tagliare (fascia in gomma, filatura, ecc.). **JPN** カットしてください。(輪ゴム、糸など)。 **CHI** 切割 (橡皮筋, 线等)。 **POR** Corte (elástico, fio, etc.). **POL** Utnij (gumkę, nitkę, itd.). **KOR** 절단(고무밴드, 이쑤시게 등)



ENG Check size. **UKR** Перевірте розмір. **FRA** Vérifiez la dimension. **DEU** Prüfen Sie die Größe. **SPA** Compruebe el tamaño. **ITA** Controllare le dimensioni. **JPN** サイズをチェックしてください。 **CHI** 测量尺寸 **POR** Verifique o tamanho. **POL** Sprawdź rozmiar. **KOR** 크기를 확인해 주세요.

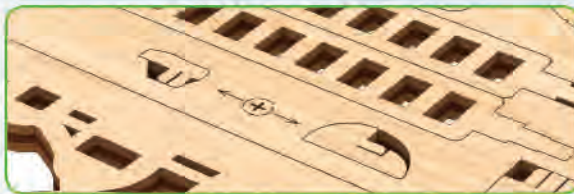

ENG Specified details come with spare duplicates. **UKR** Зазначені деталі є на дошках як запасні. **FRA** Les détails spécifiés sont fournis avec des doublons de rechange. **DEU** Die angegebenen Details werden mit Ersatzduplikaten geliefert. **SPA** Los detalles especificados vienen con duplicados de repuesto. **ITA** I dettagli specificati vengono forniti con duplicati di riserva. **JPN** 指定された詳細には予備の複製が付属しています。 **CHI** 指定的細節帶有備用副本。 **POR** Os detalhes especificados vêm com peças sobressalentes duplicadas. **POL** Zapasowe elementy są zaznaczone na desce. **KOR** 명시된 세부 사항은 여분의 복사본과 함께 제공됩니다.



ENG This is not a structural component; it is a tool for measurement and assembly. **UKR** Це не деталь конструкції, а допоміжний інструмент для складання або вимірювання відстаней. **FRA** Cette pièce ne fait pas partie de la construction mais constitue un outil annexe pour l'assemblage ou la mesure des distances. **DEU** Es ist kein Teil der Konstruktion, sondern ein Hilfselement für den Zusammenbau oder für das Messen der Abstände. **SPA** No es una pieza de la construcción sino un instrumento auxiliar para montar o para medir distancias. **ITA** Non è un componente del modello, ma un'attrezzatura aggiuntiva per il montaggio o il rilievo delle quote. **JPN** この部品は完成時の部品ではなく、組み立てをサポートしたり測定する道具です。 **CHI** 这不是装配零部件，是一种测量及安装辅助工具。 **POR** Este não é um componente estrutural, é uma ferramenta para medição e montagem. **POL** To nie detal konstrukcji, a pomocnicze narzędzie dla montażu i wymiaru odległości. **KOR** 이 부품은 조립을 위한 부품이 아니고 조립을 돕거나 측정을 위한 도구입니다.

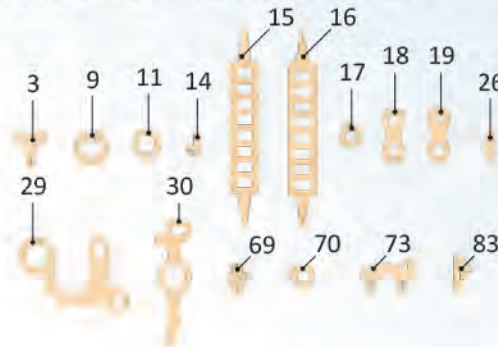

Mechanical models



→ **ENG** It's easier to pull out some parts with the «helper (H)». **UKR** Буде легше видавити готові деталі за допомогою «helper (H)». **FRA** Il est plus facile de retirer certaines pièces avec la pièce-outils (H). **DEU** Es ist einfacher, einige Teile mit dem "Helfer (H)" herauszunehmen. Siehe Beispiel: **SPA** Para separar algunas partes resulta más fácil utilizando la ayuda del elemento "H". **ITA** È più facile estrarre alcuni elementi utilizzando l'«aiuto (H)». **JPN** ある部品は「helper (H)」を使うと取り外しやすいです。 **CHI** 使用「helper (H)」可以更轻松地拉出某些零件。 **POR** É mais fácil retirar algumas peças usando a «peça auxiliar(H1)». **POL** Niektóre części łatwiej jest wyciągnąć za pomocą "pomocnika (H)". **KOR** 일부 부품은 'H' 도구를 이용하여 떼어내면 쉽습니다.

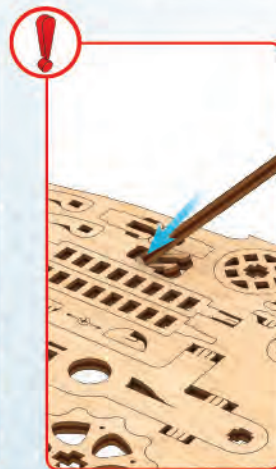
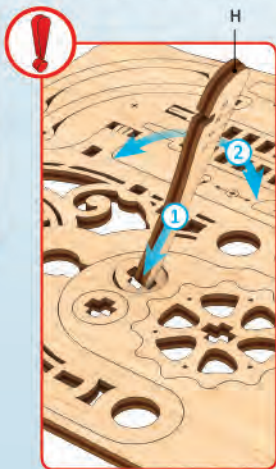

1

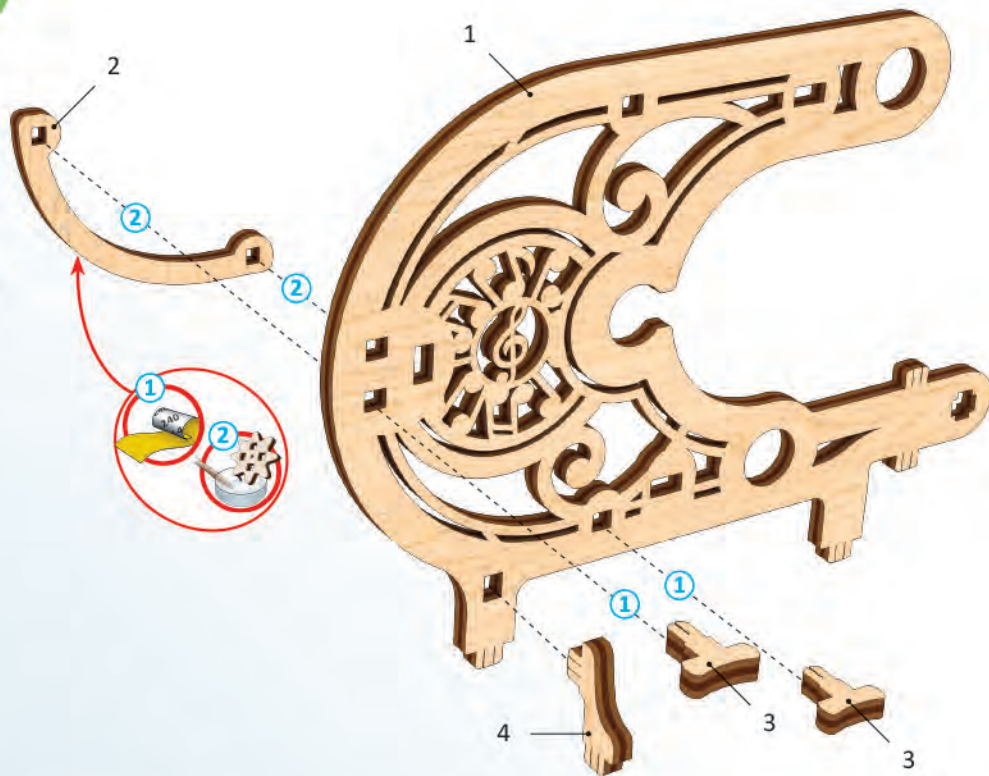

ENG Pay attention. Check position of the part. **UKR** Зверніть увагу. Перевірте розташування елемента. **FRA** Faites attention. Vérifiez la disposition de l'élément. **DEU** Bitte Beachten. Prüfen Sie die Einbaulage des Elementes. **SPA** Atención. Compruebe la situación del elemento. **ITA** Prestare attenzione. Controllare la posizione del componente. **JPN** 方向及び位置に注意して組み立ててください。 **CHI** 注意! 检查部件方向和位置 **POR** Preste atenção à posição da peça. **POL** Zwróć uwagę. Sprawdź lokalizację elementu. **KOR** 방향 또는 위치에 주의해서 조립해 주세요.



ENG Wax the part with a regular candle (rub with a candle). **UKR** Змастіть деталь звичайною свічкою (потріть об свічку). **FRA** Lubrifiez la pièce avec une bougie ordinaire (frottez contre la bougie). **DEU** Reiben Sie das Teil mit einer einfachen Kerze etwas ein. **SPA** Engrase la pieza con una vela común (frote con una vela). **ITA** Incerare il componente (sfregare con la cera). **JPN** された部分に潤滑剤としてろうソクを塗ってください。 **CHI** 用普通蜡烛涂沫润滑部件 **POR** Encere a peça com uma vela comum (esfregue em uma vela). **POL** Przesmaruj zwykłą świecą. **KOR** 표시된 부분에 윤활을 위해 촛을 칠해 주세요.



ENG Sand to remove burrs. **UKR** Видаліть задирки. **FRA** Eliminez les bavures. **DEU** Grate entfernen. **SPA** Quite las rebabas. **ITA** Togliere le bave. **JPN**バリ取りのサンドペーパー **CHI** 磨掉毛刺 **POR** Lixe para remover rebarbas. **POL** Usuń zadzior. **KOR** 거친 부분을 다듬어 주세요.

2

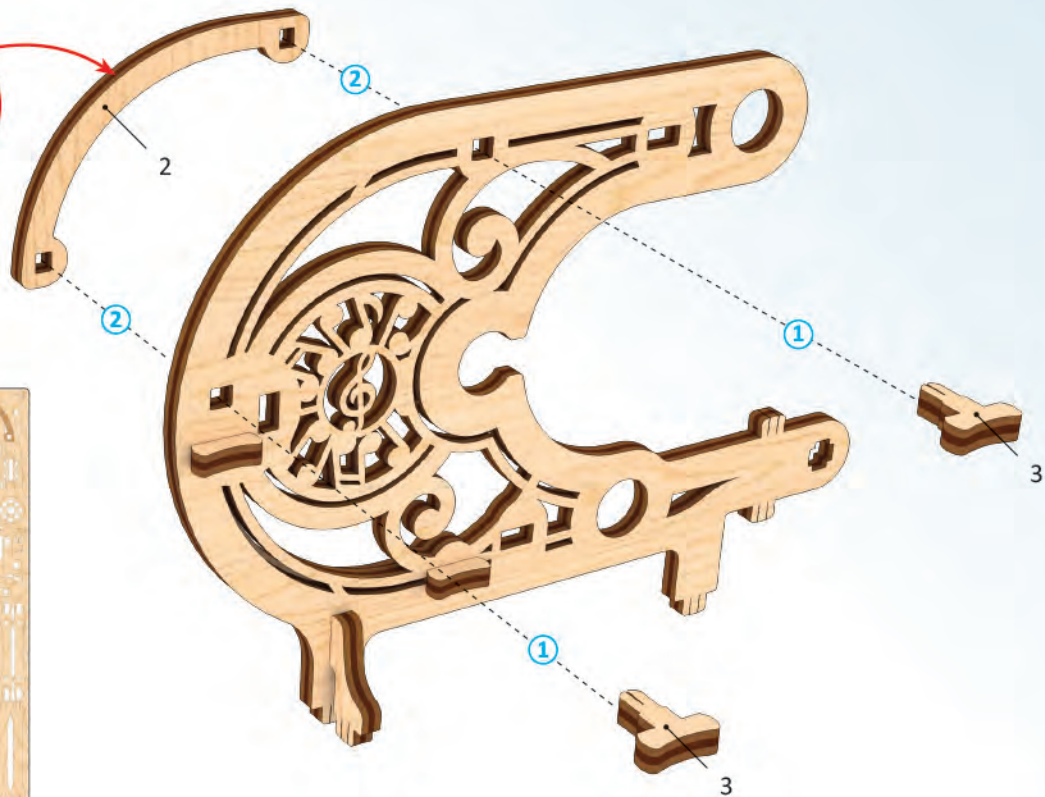
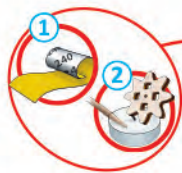

a1



5

1

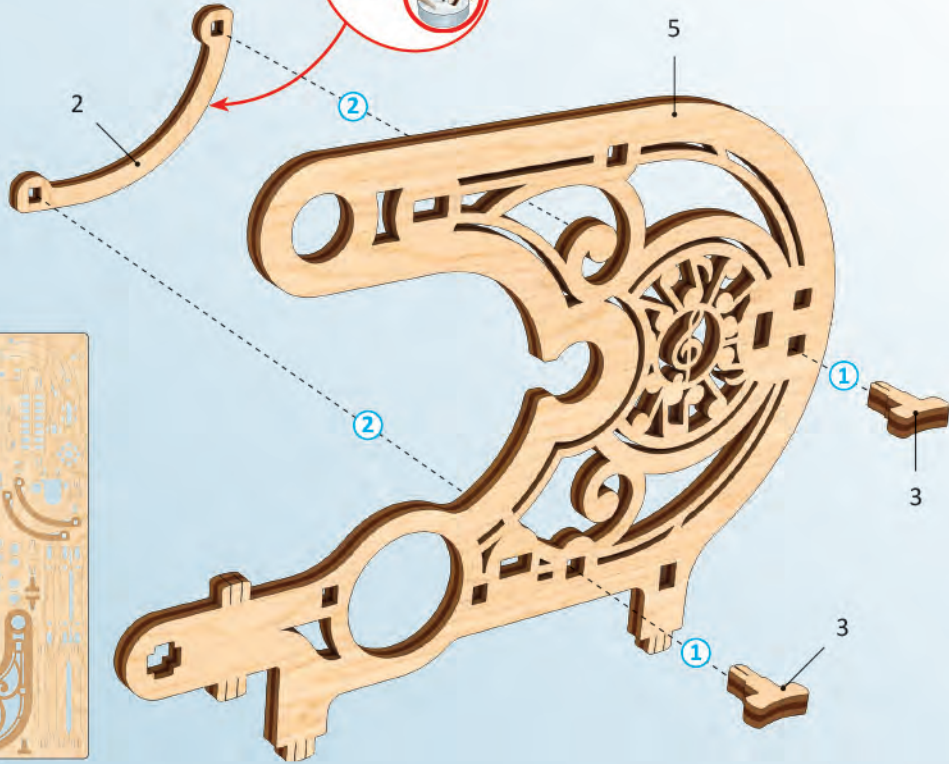

2

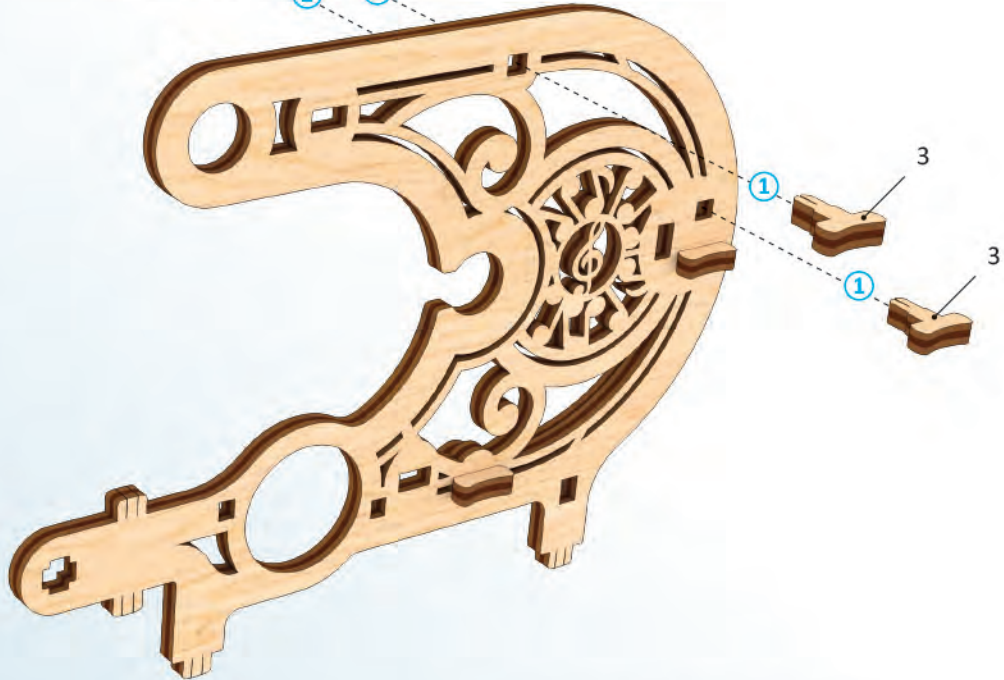

6

①

①

3

①

3

②

②

①

①

3

3

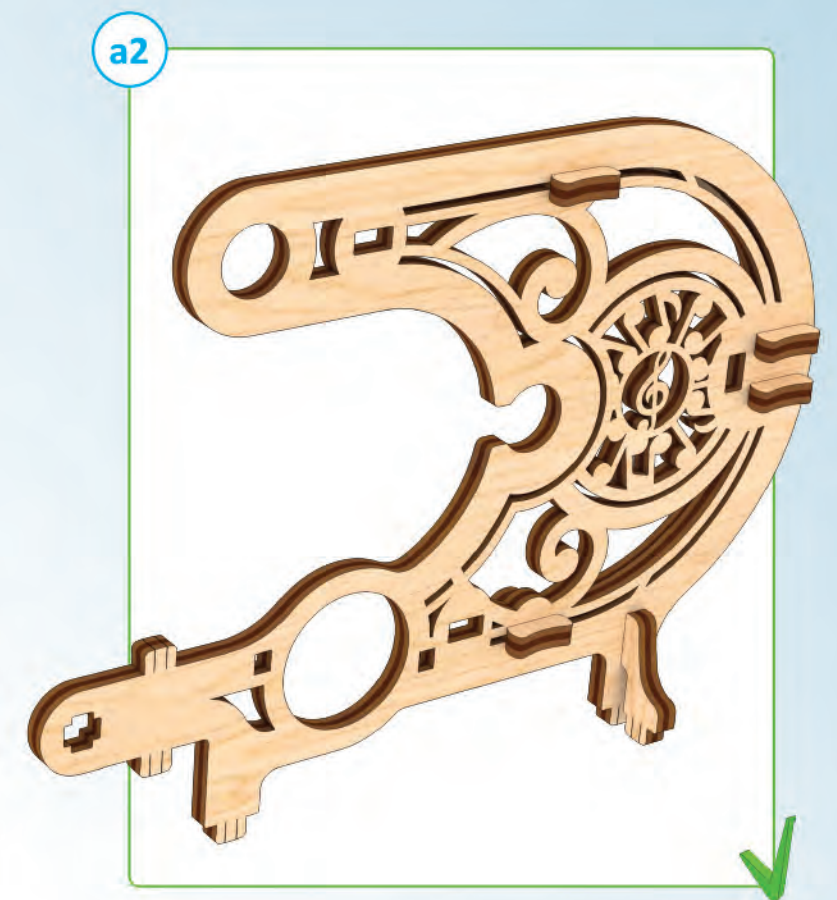
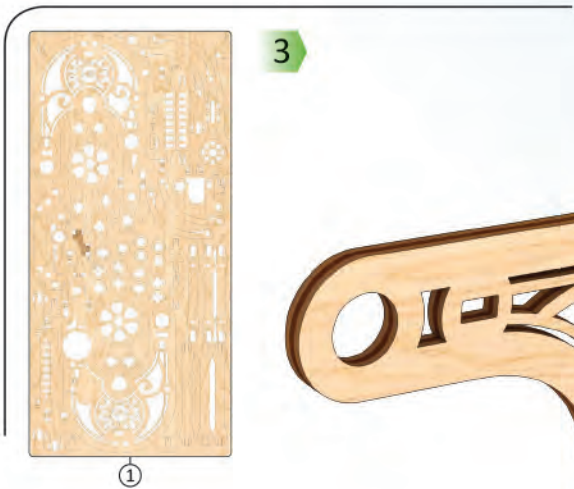

Mechanical models



1

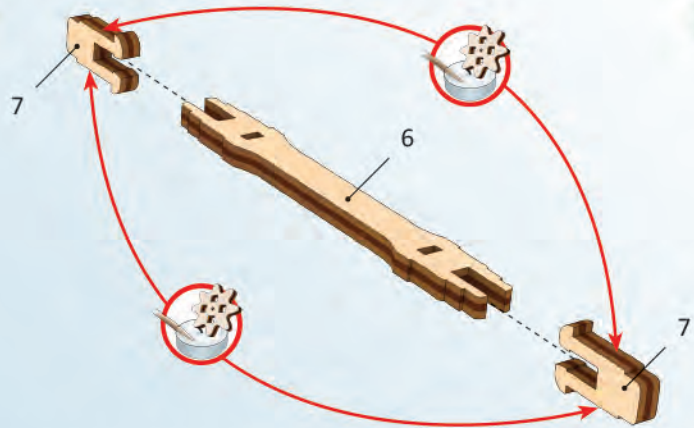

2

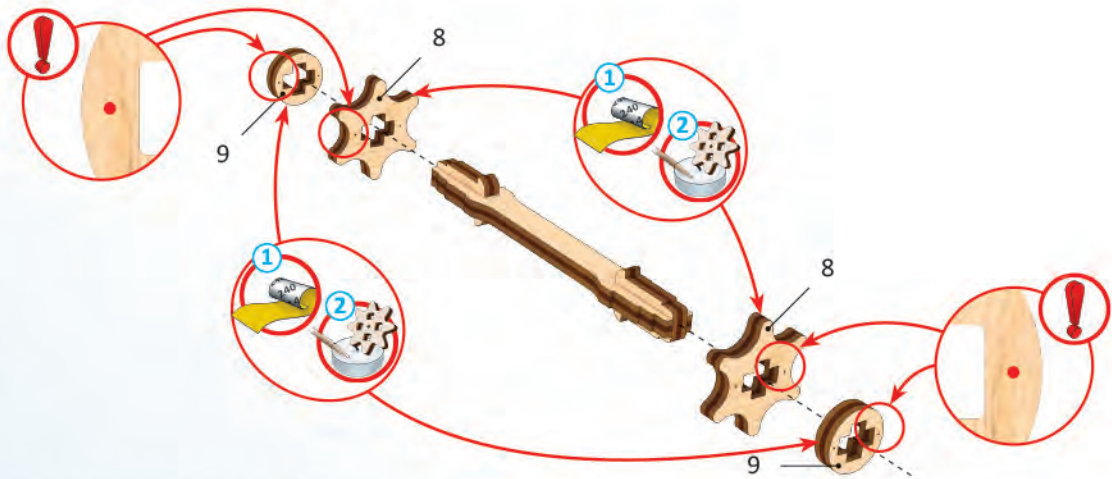

3

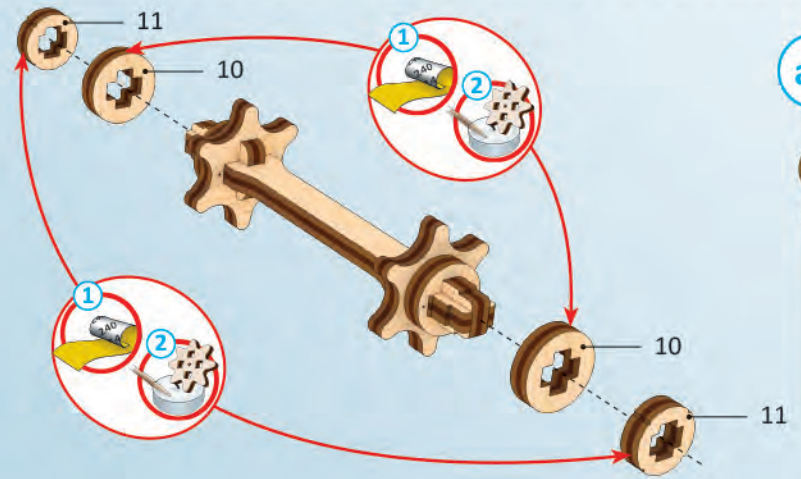

a3



1

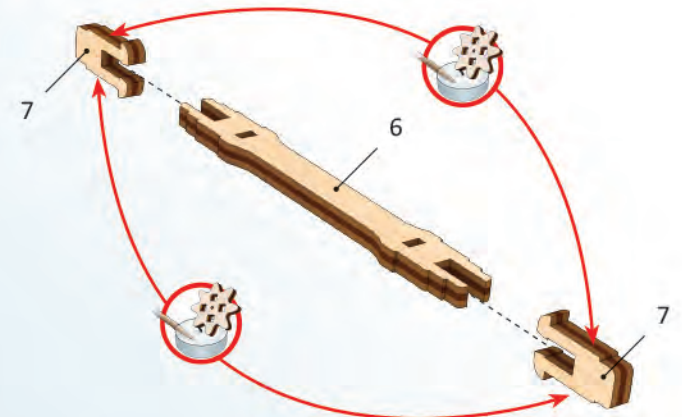

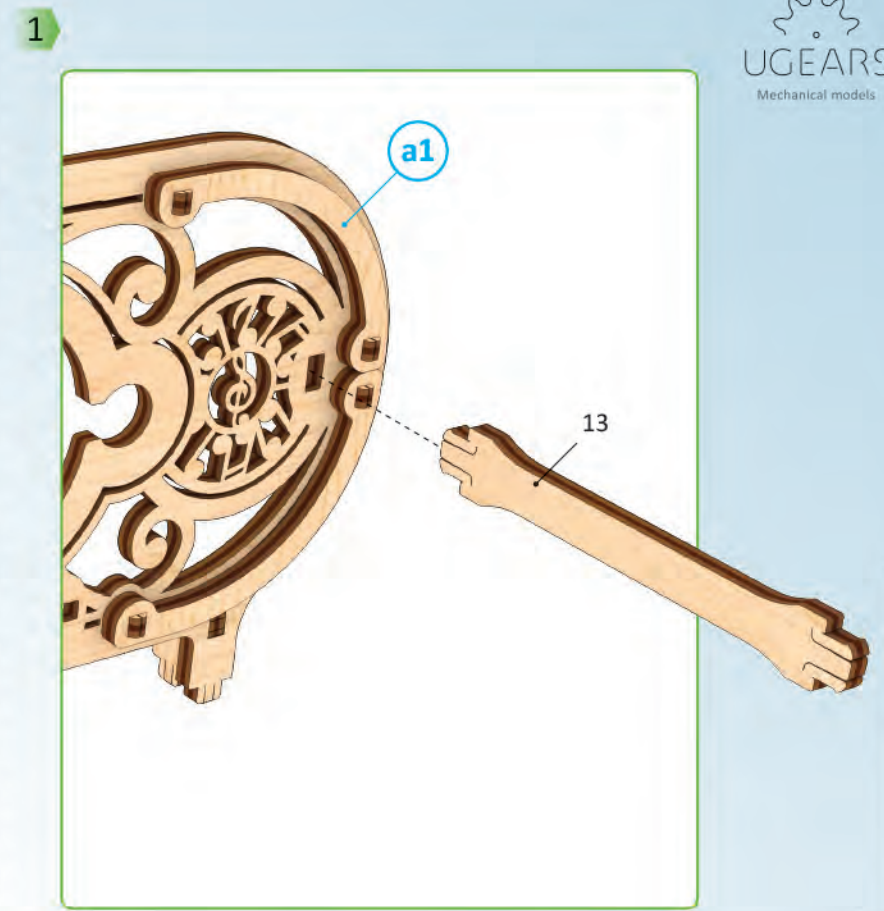
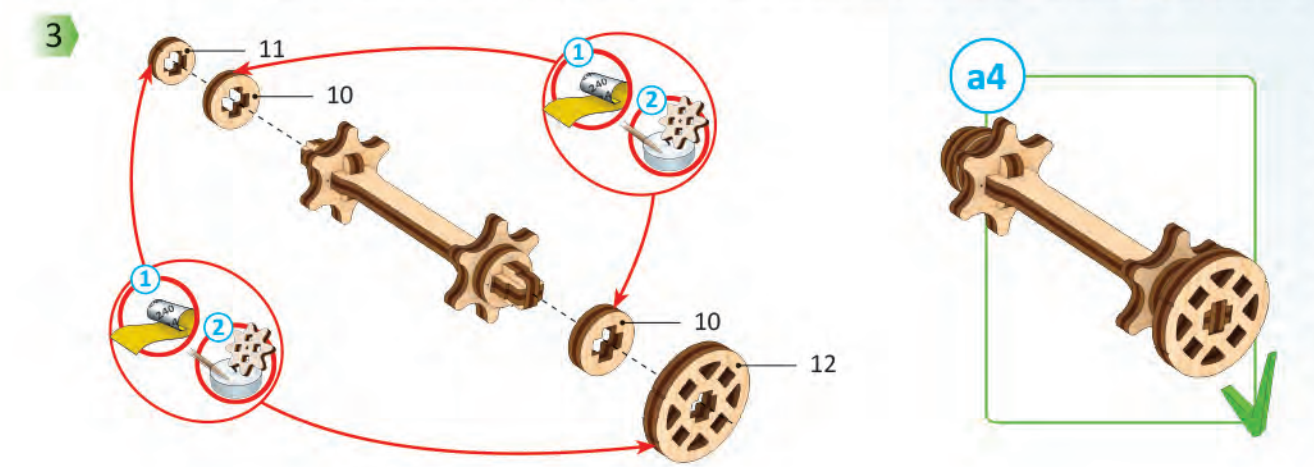
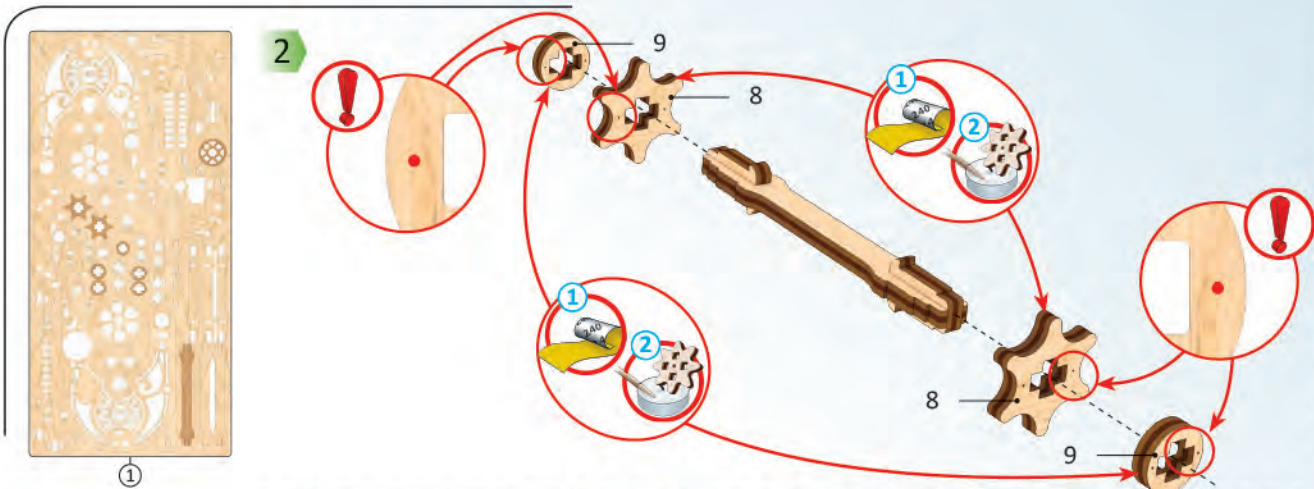



2

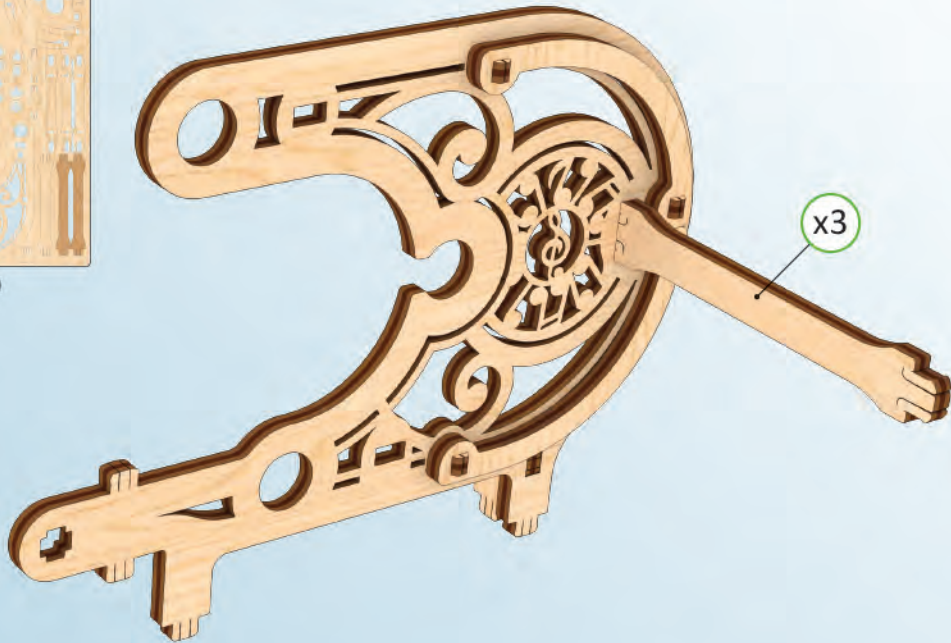

3

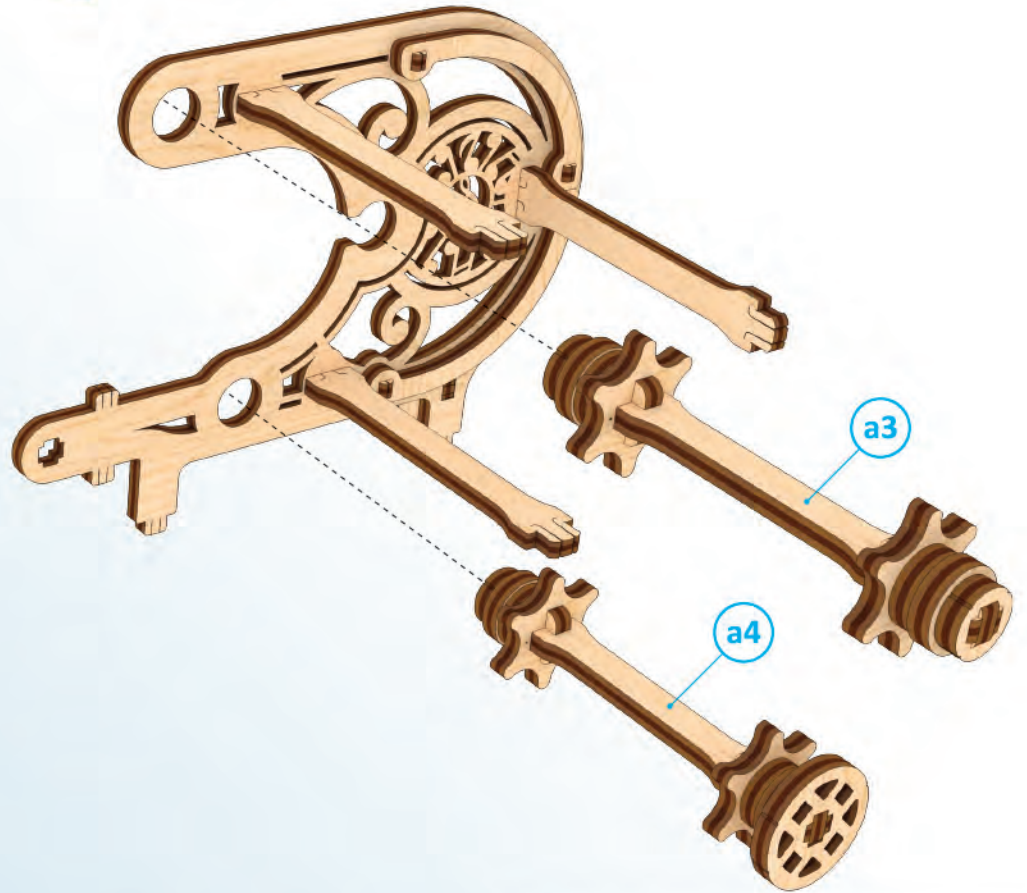

4

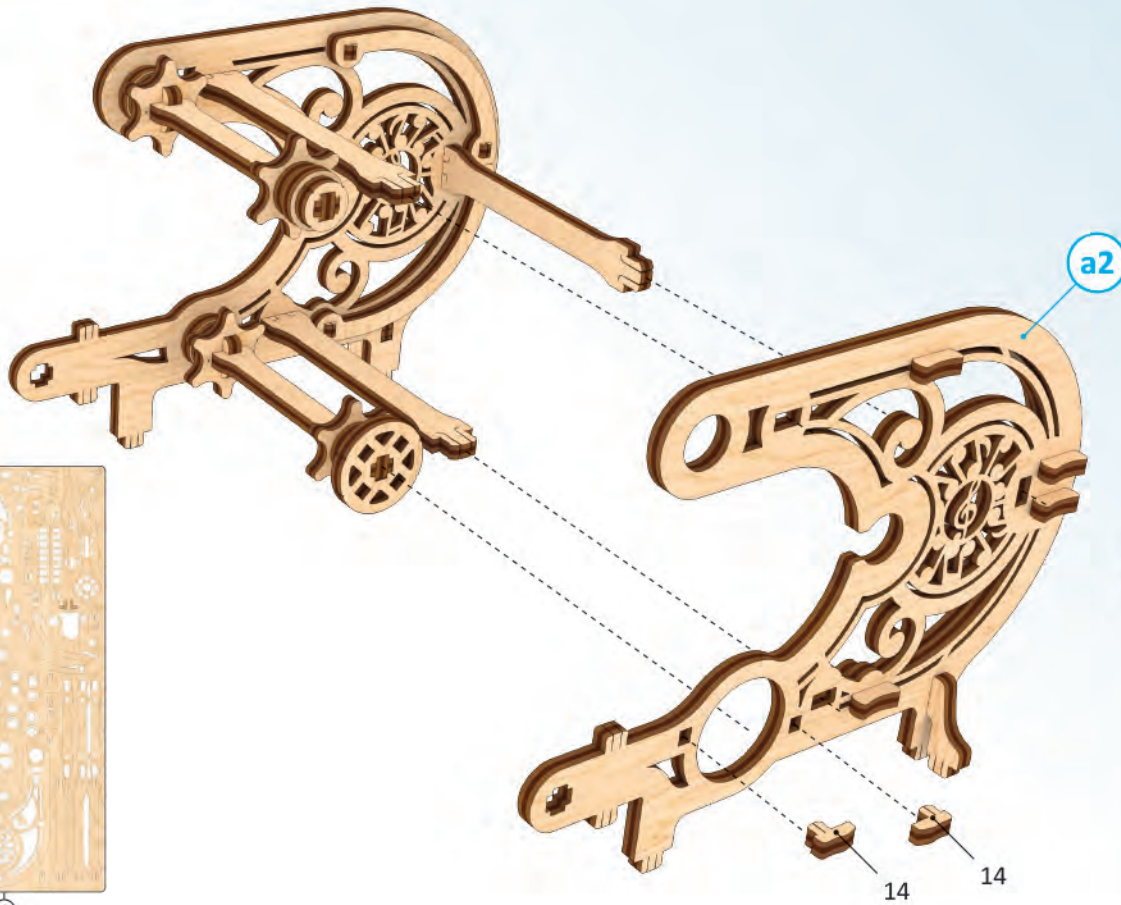

a5

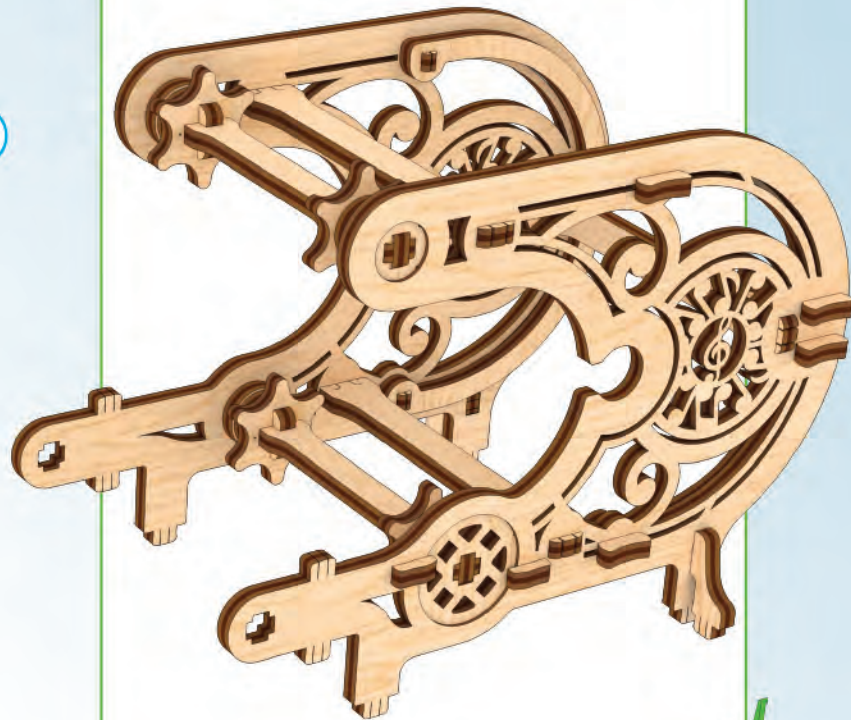

Mechanical models

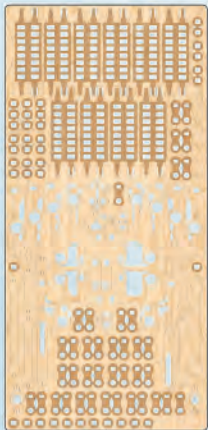

1

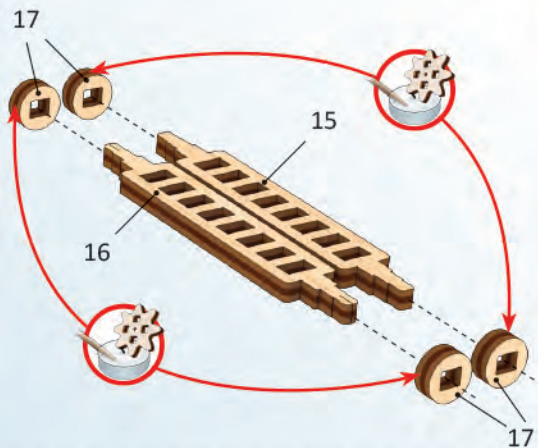
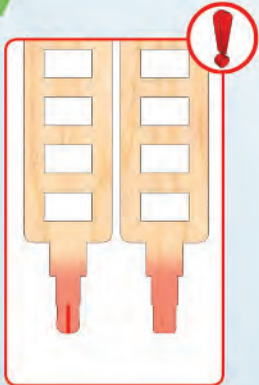

2

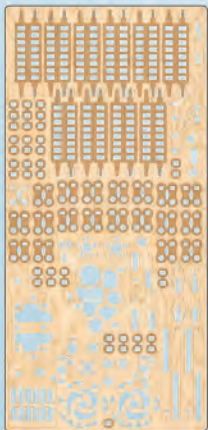
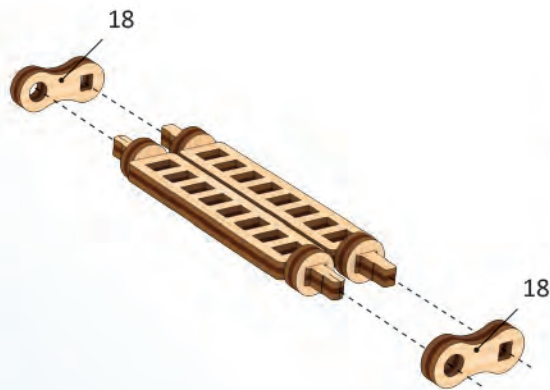

3

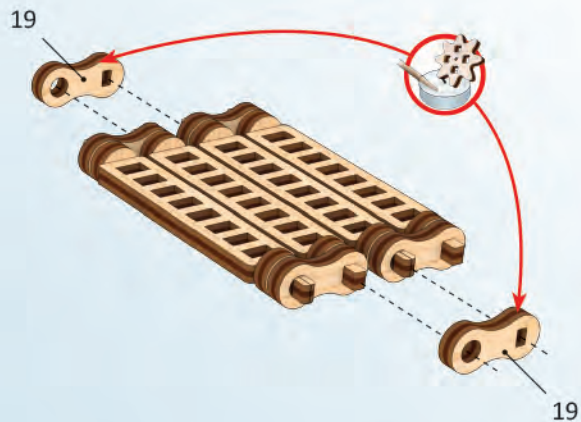
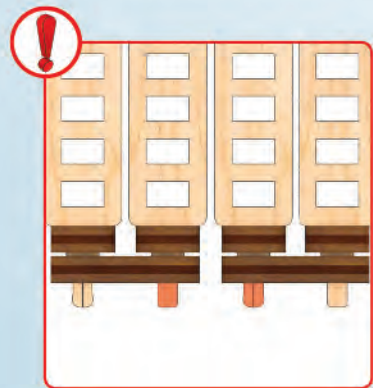

4

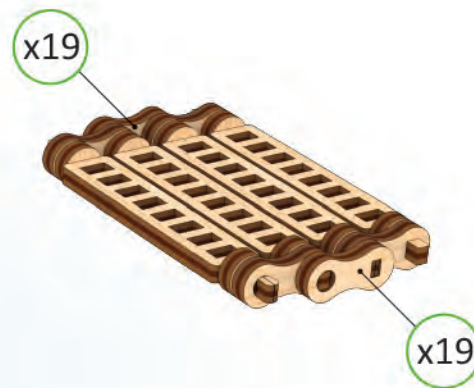

a6

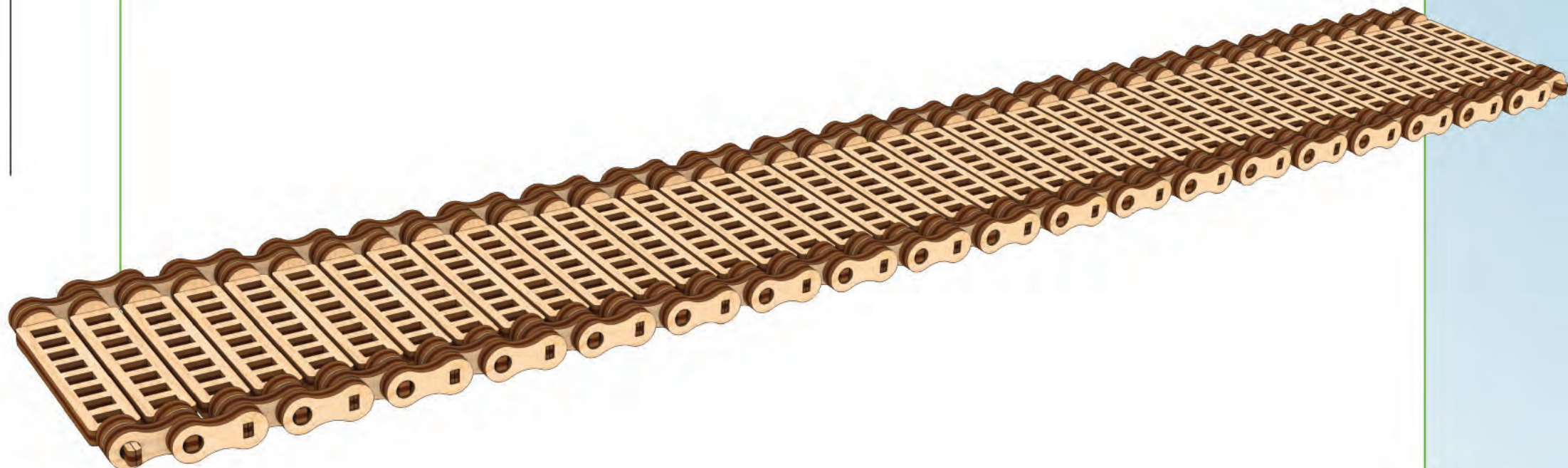

1

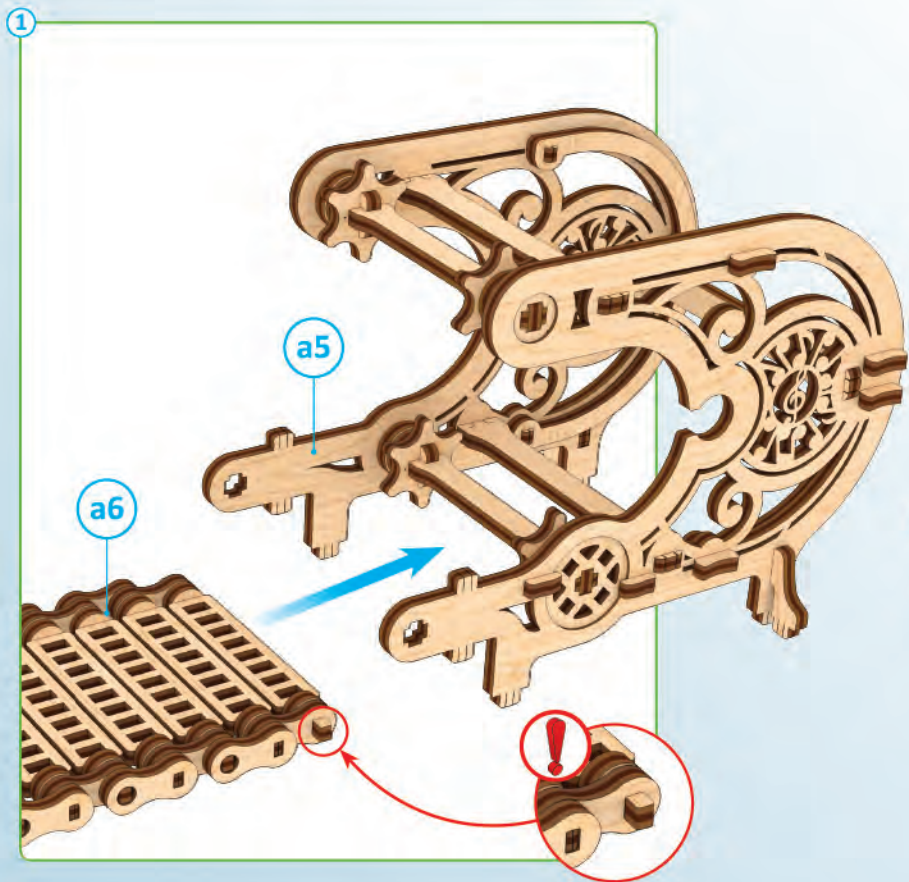

2

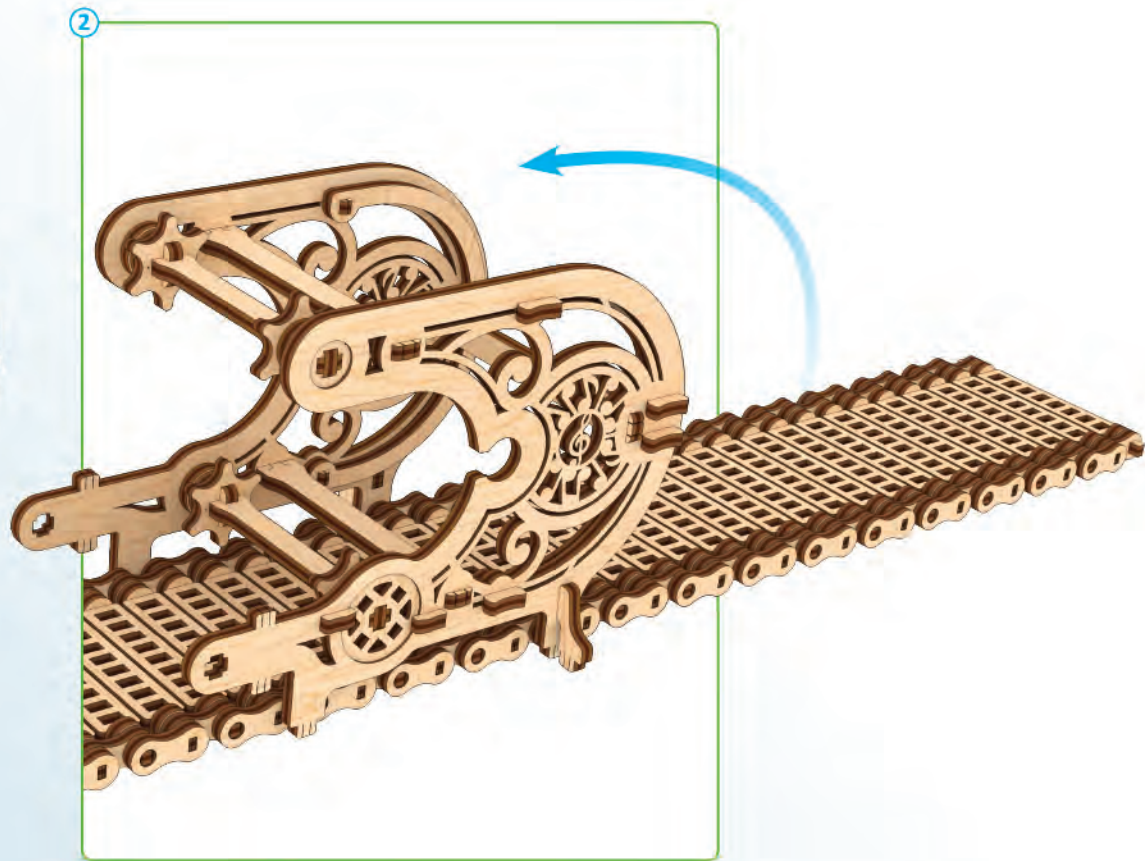

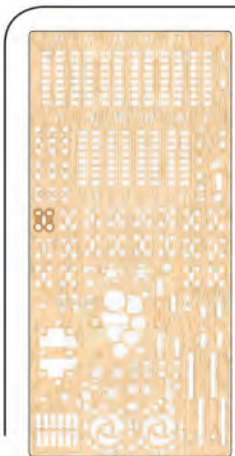

3

3

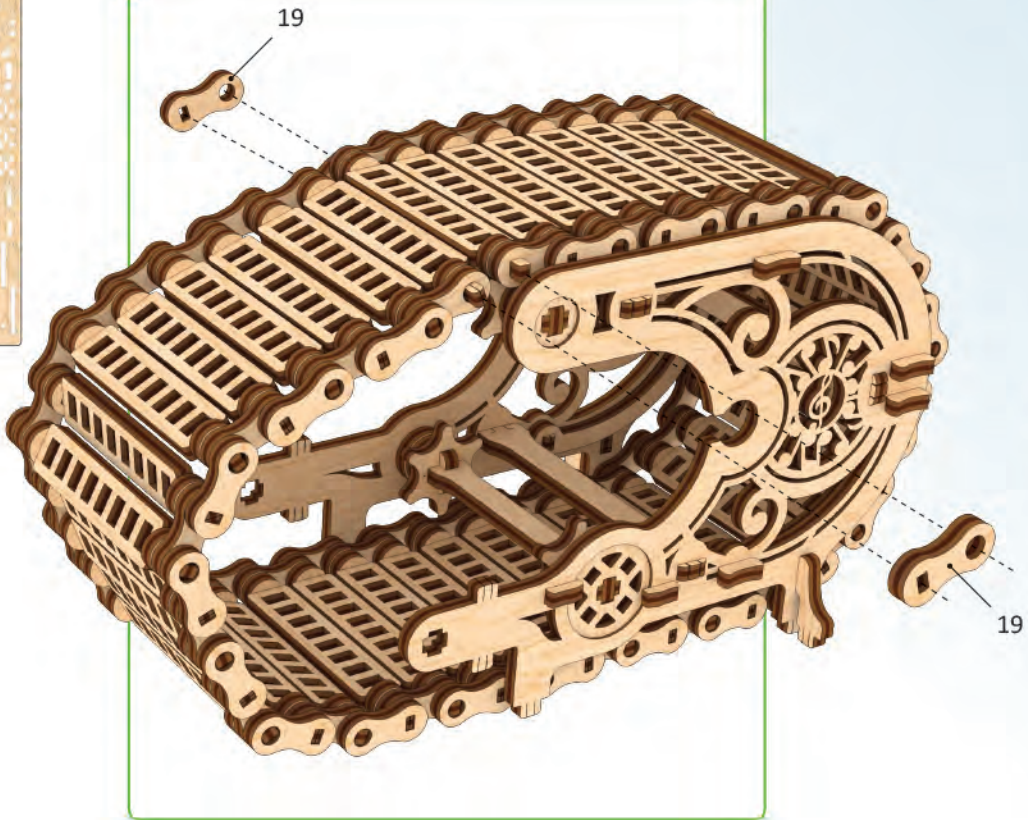

a7



1

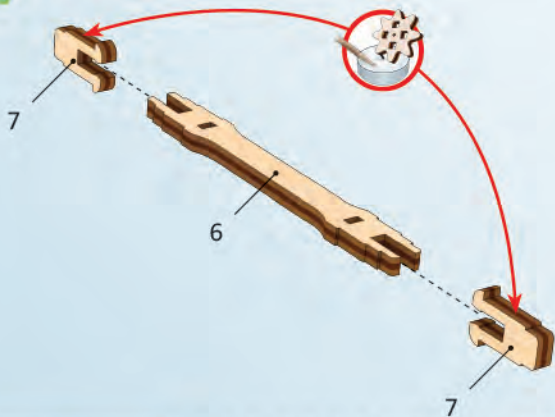

2

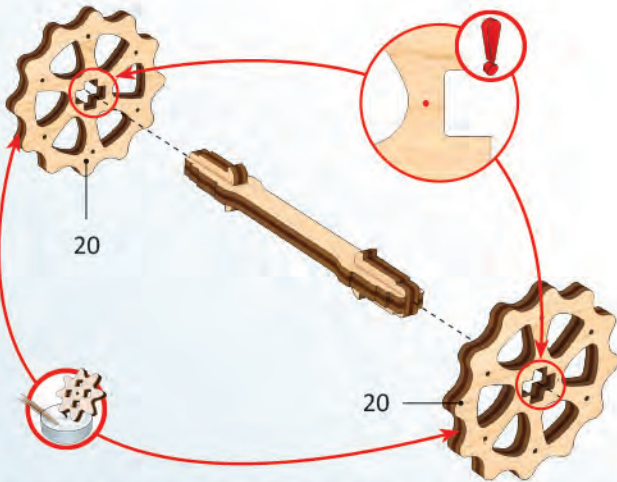

1

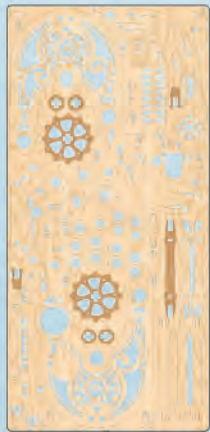
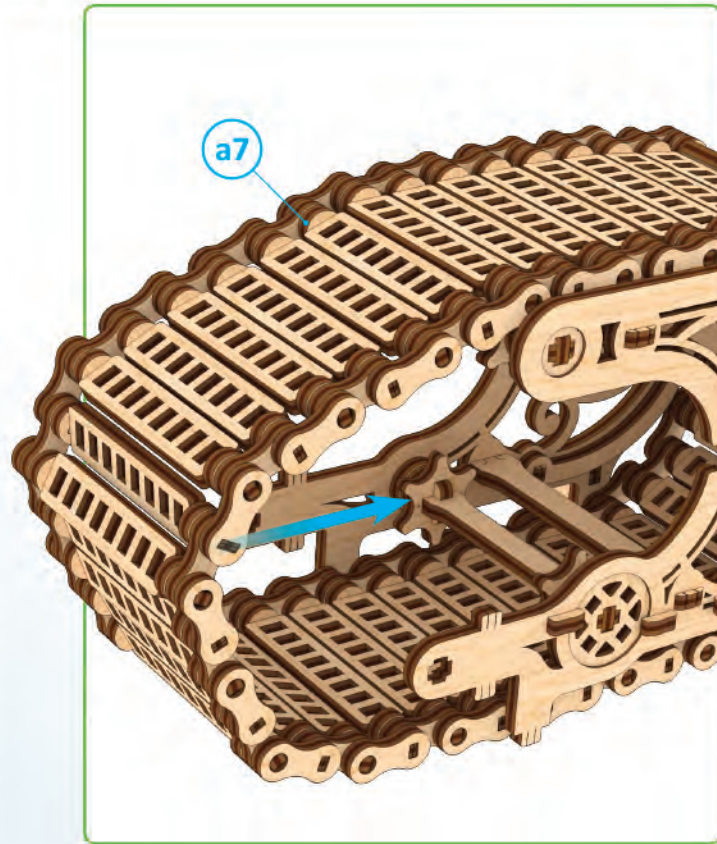

3

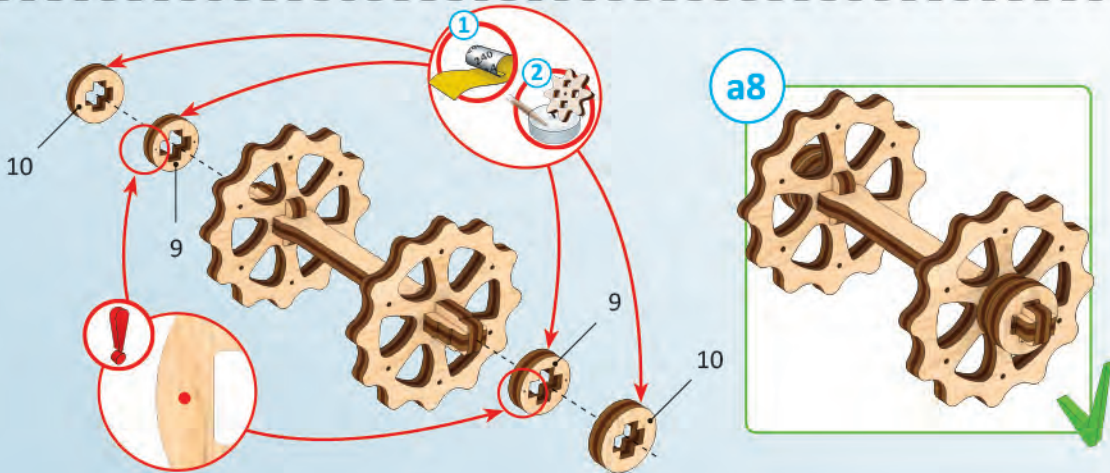

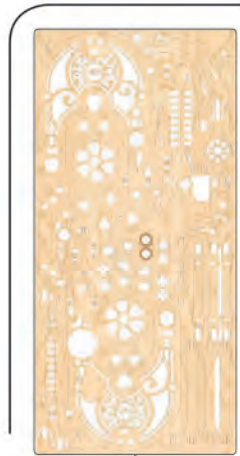

2

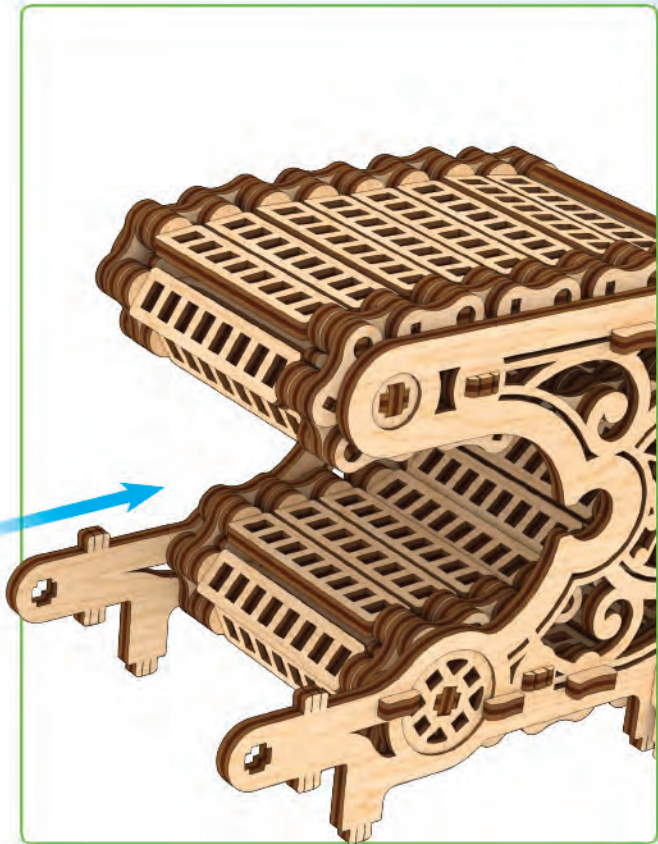
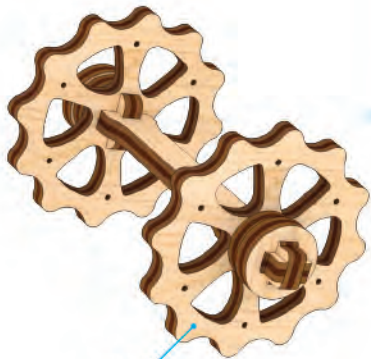

a9

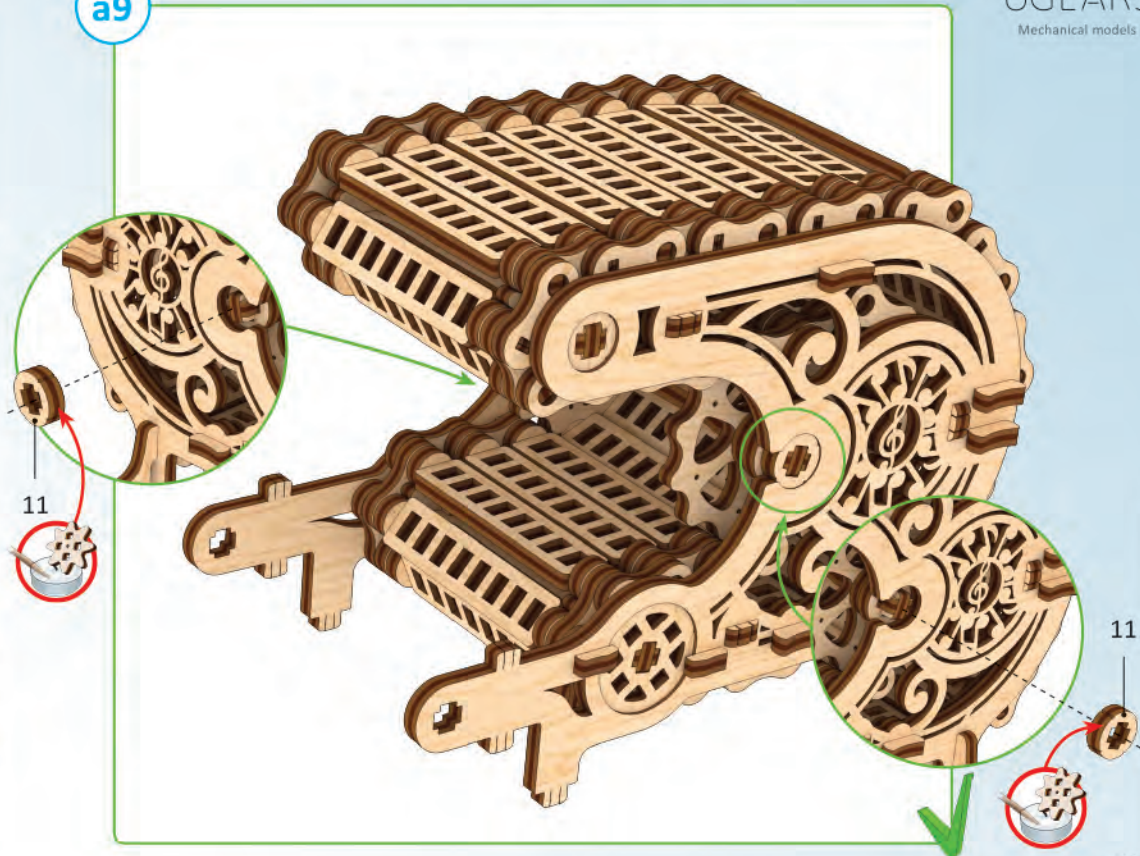

1

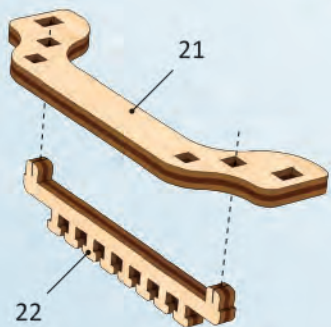

2

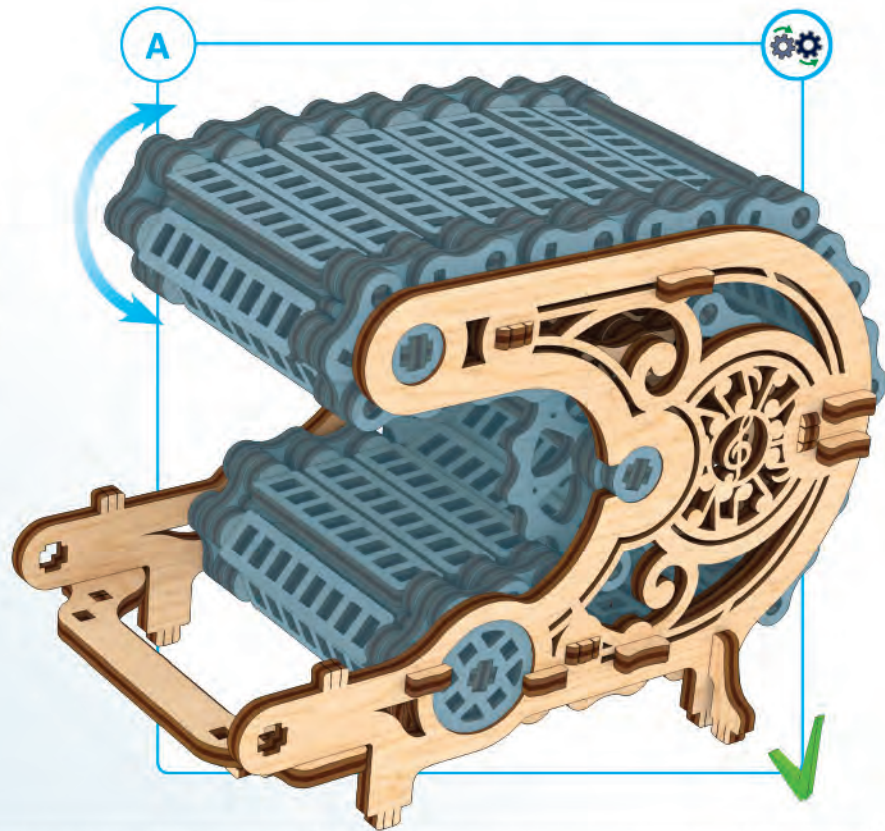
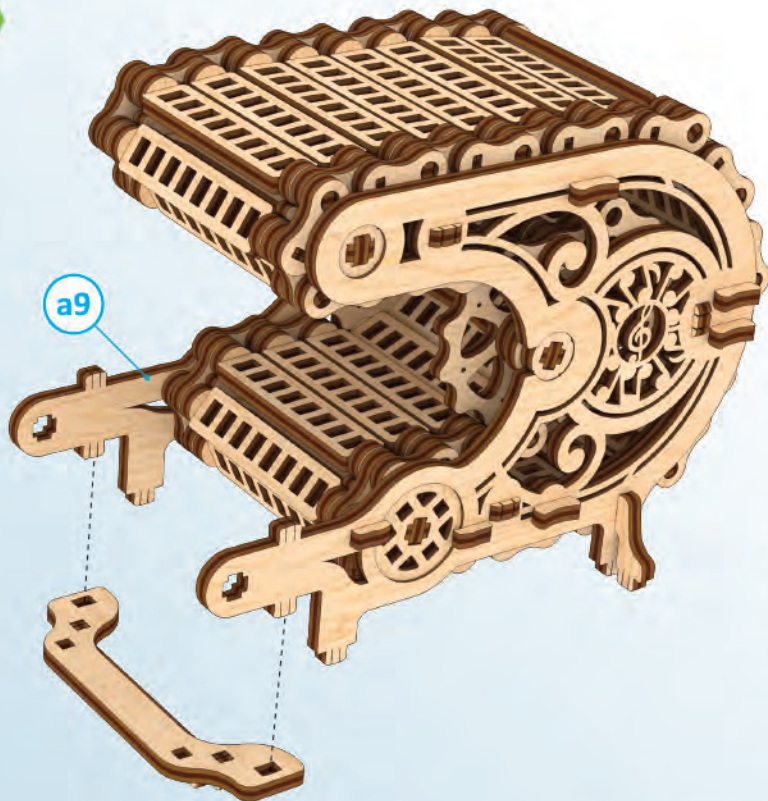

1



ENG Check the mechanism for smoothness and accuracy of movement. Operate the mechanism so the parts would seat-in. **UKR** Перевірте механізм на плавність і точність ходу. Розробіть механізм. **FRA** Vérifiez si le mécanisme fonctionne en douceur et avec précision. Faites fonctionner le mécanisme jusqu'à son fonctionnement normal. **DEU** Prüfen sie den Mechanismus bezüglich der Laufruhe und der Genauigkeit des Ganges. Betätigen Sie den Mechanismus mehrmals. **SPA** Verifique la suavidad y precisión del mecanismo. Desarrolle el mecanismo. **ITA** Controllare la scorrevolezza e la precisione del movimento. Far funzionare il meccanismo. **JPN** 駆動部分が滑らかに動くかを確認しながら作業をすすめます。 **CHI** 检查机构的运行平稳度和精密度。调整机构。 **POR** Teste a suavidade e precisão do movimento do mecanismo. Opere o mecanismo para que as peças se encaixem. **POL** Sprawdź płynność i dokładność ruchu mechanizmu. Dopracuj mechanizm. **KOR** 구동 부분의 원활한 작동과 정확한 움직임을 확인하세요.

1

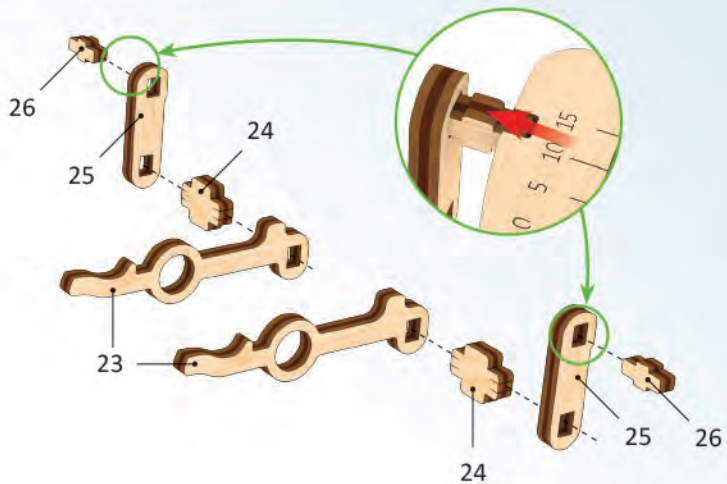
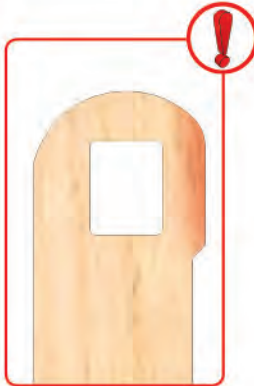

b1

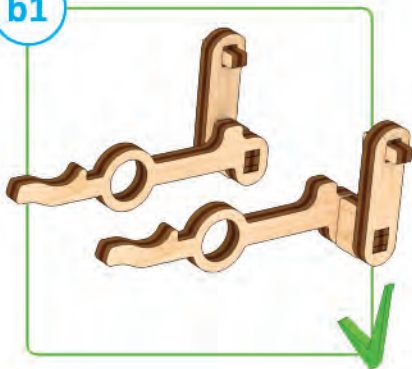

1

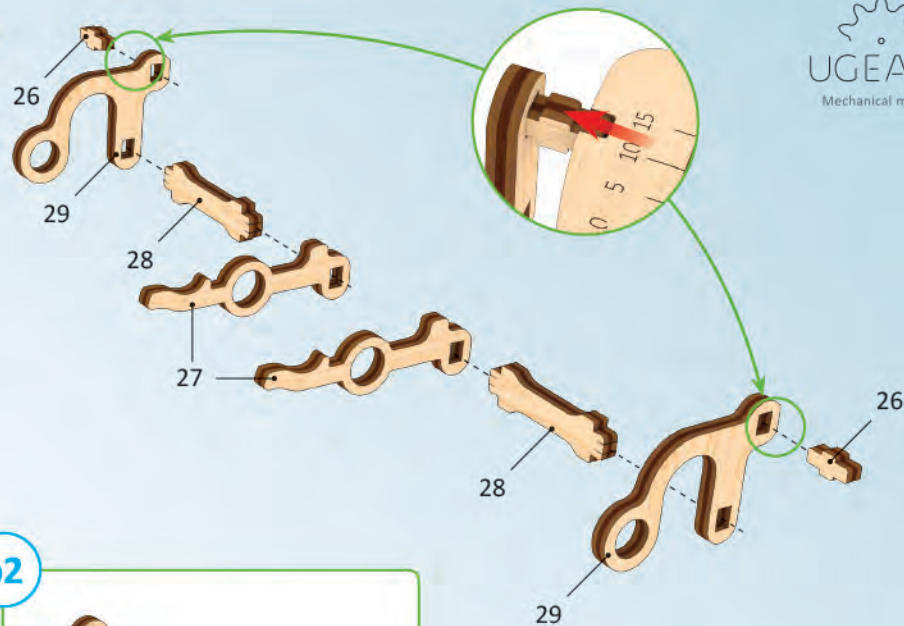

b2

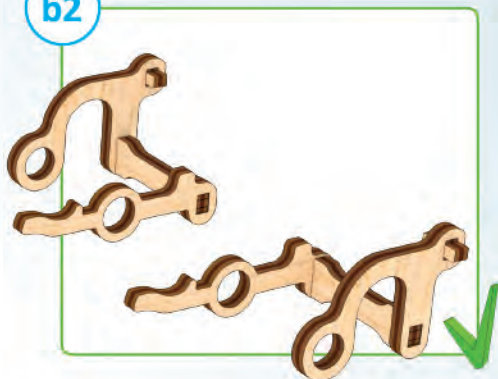

Mechanical models

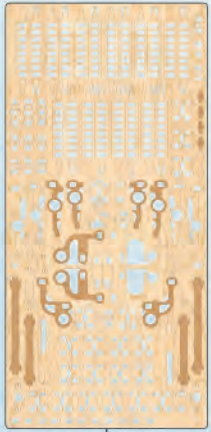

1

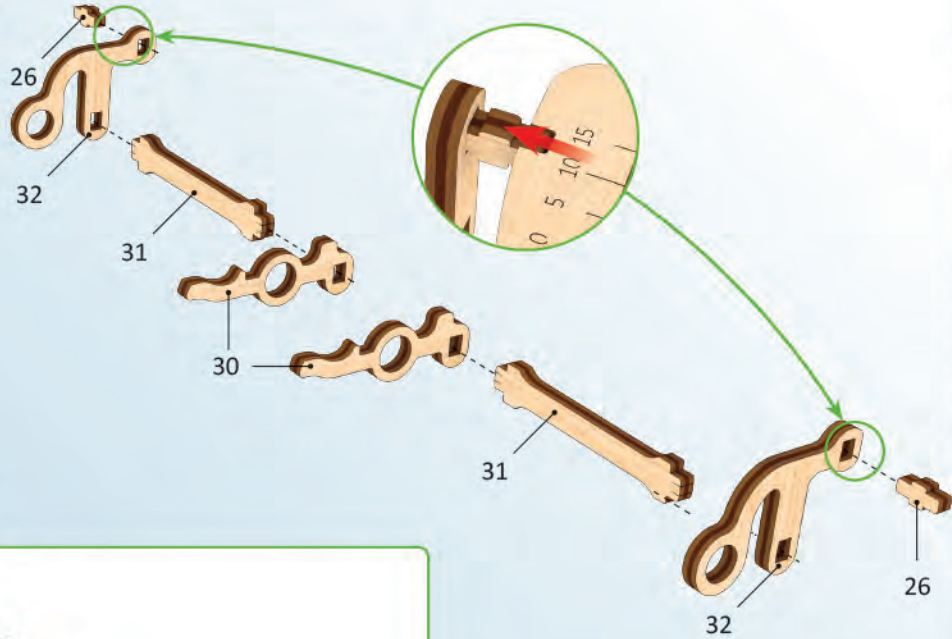

b3

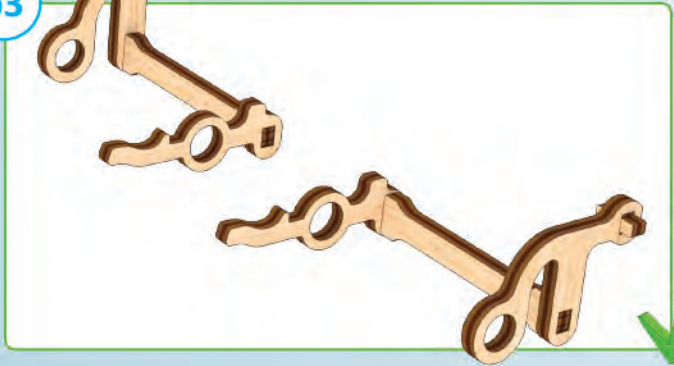

1

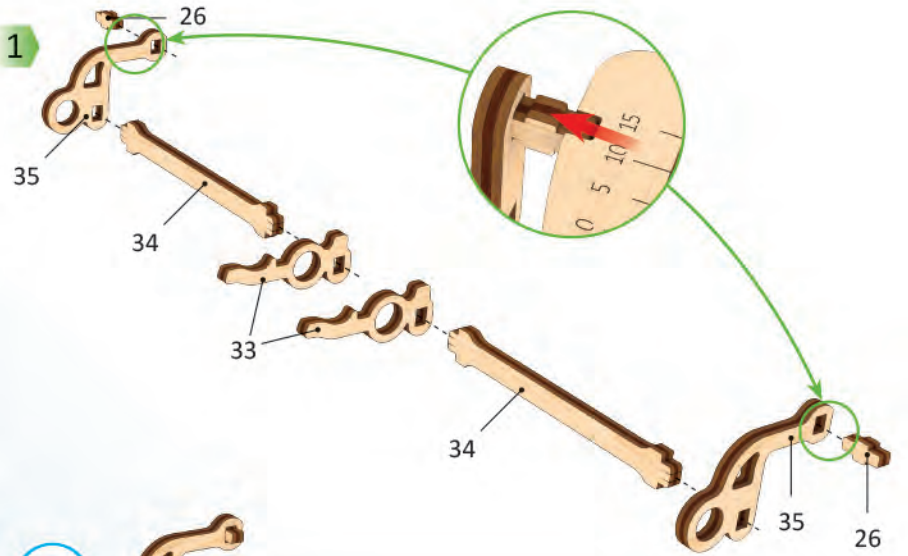

b4



1

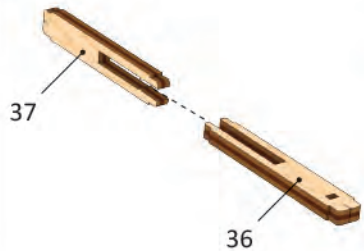

2

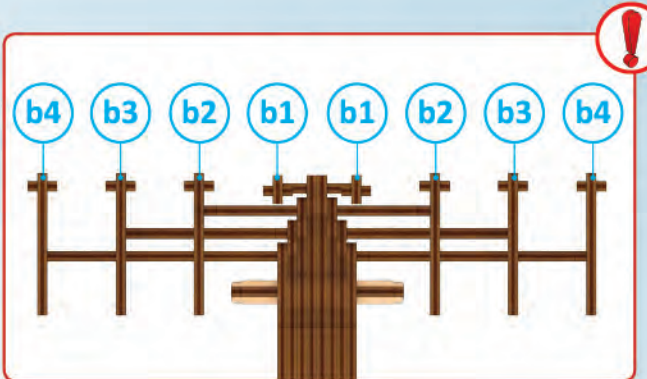
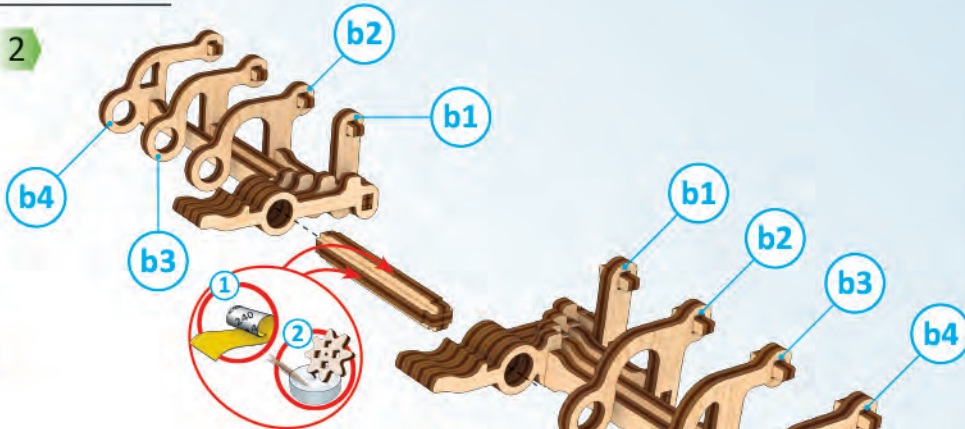

3

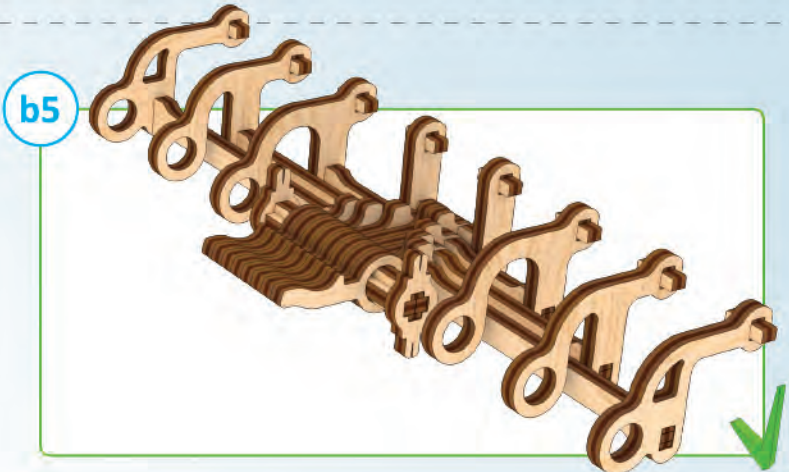
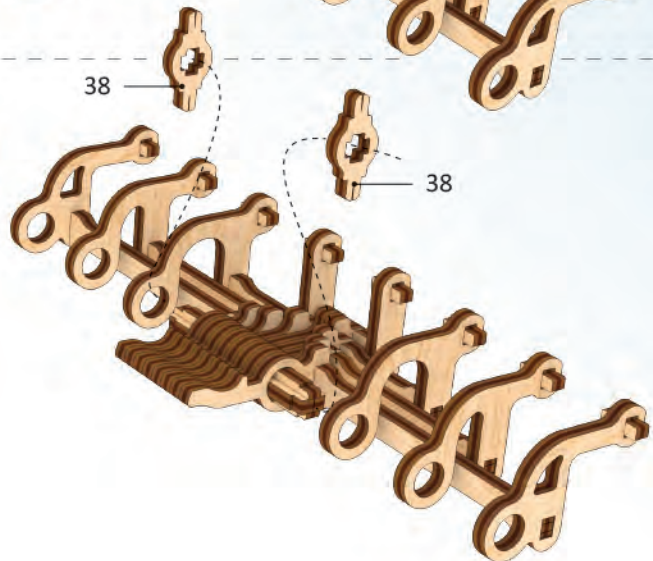
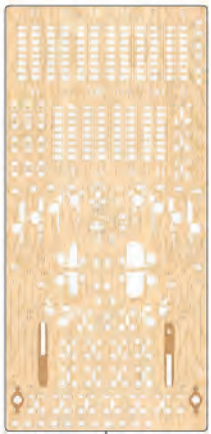

1

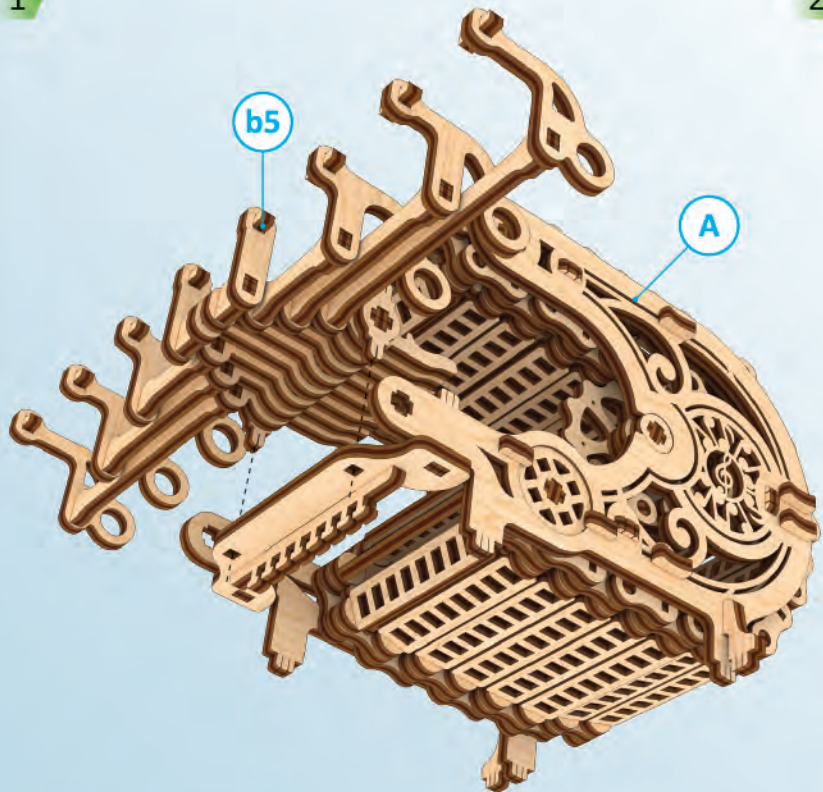

2

$h \approx 0.06'' / 1,5 \text{ mm}$
 $D \approx 0.4'' / 10 \text{ mm}$

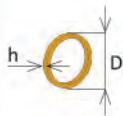

b2

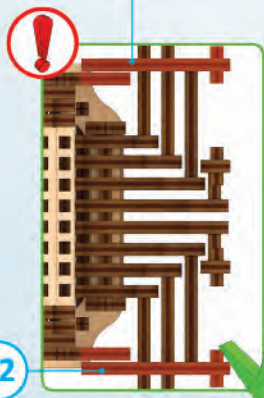

b2

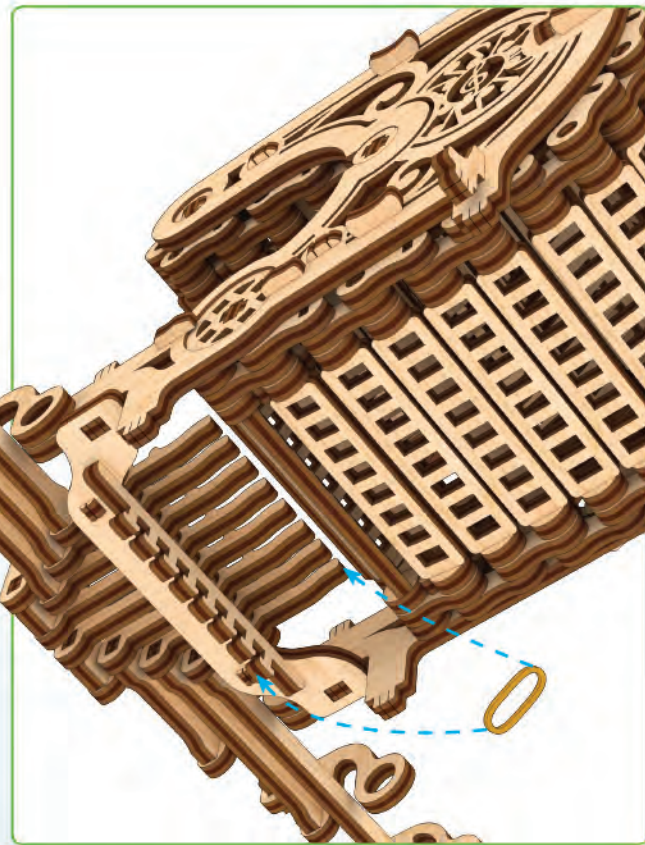
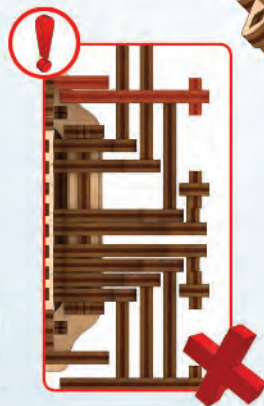

3

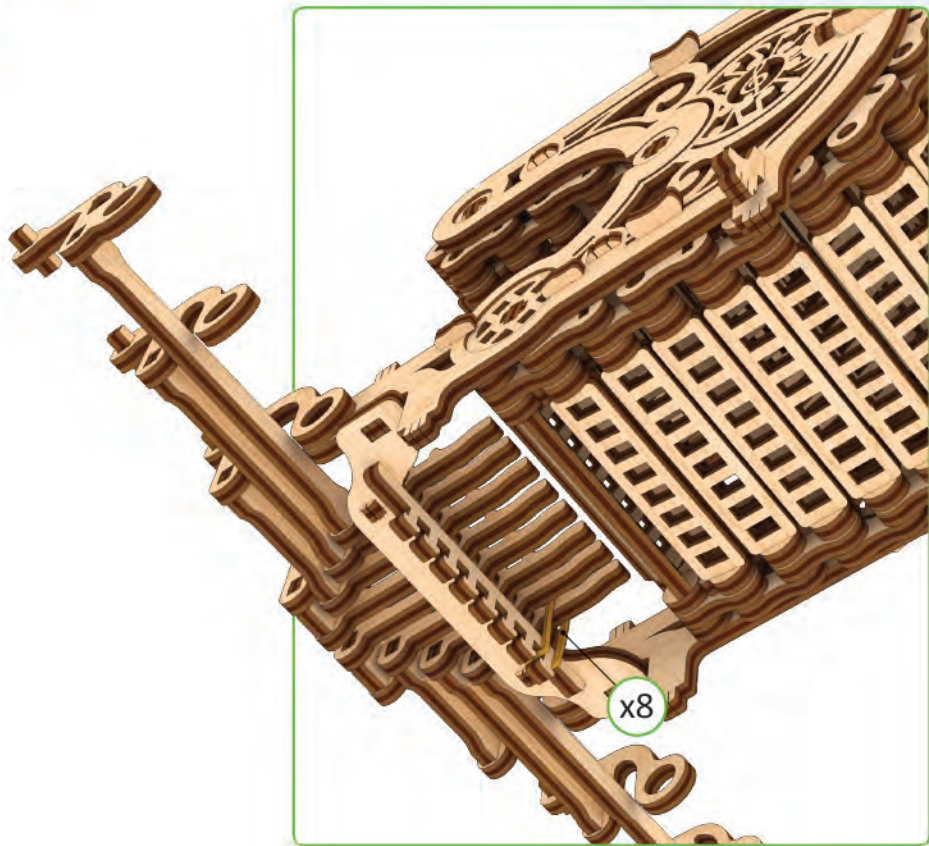

b6

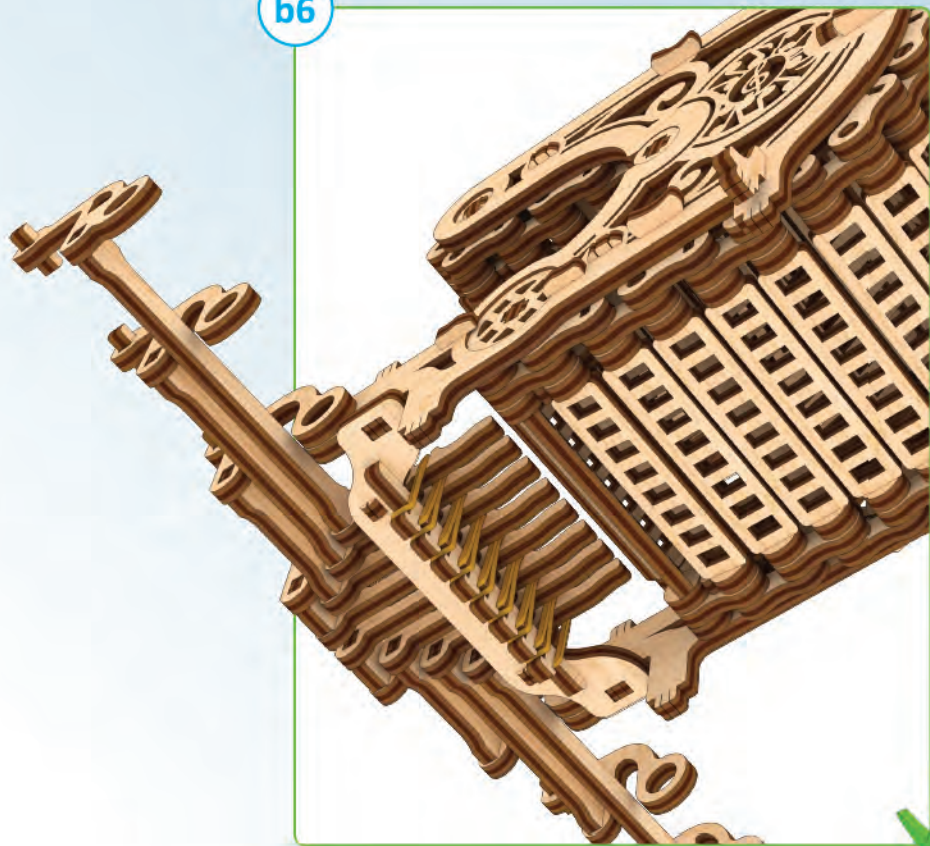

1

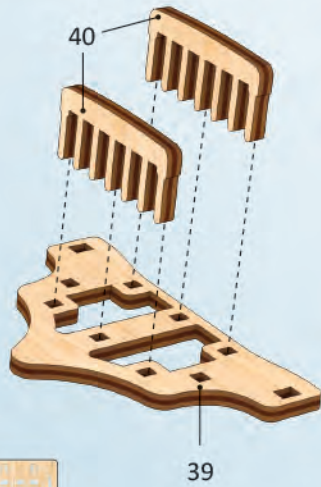

2

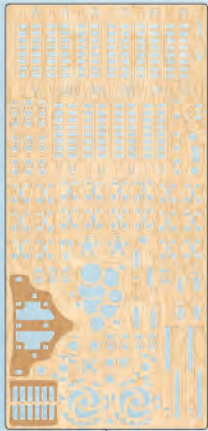
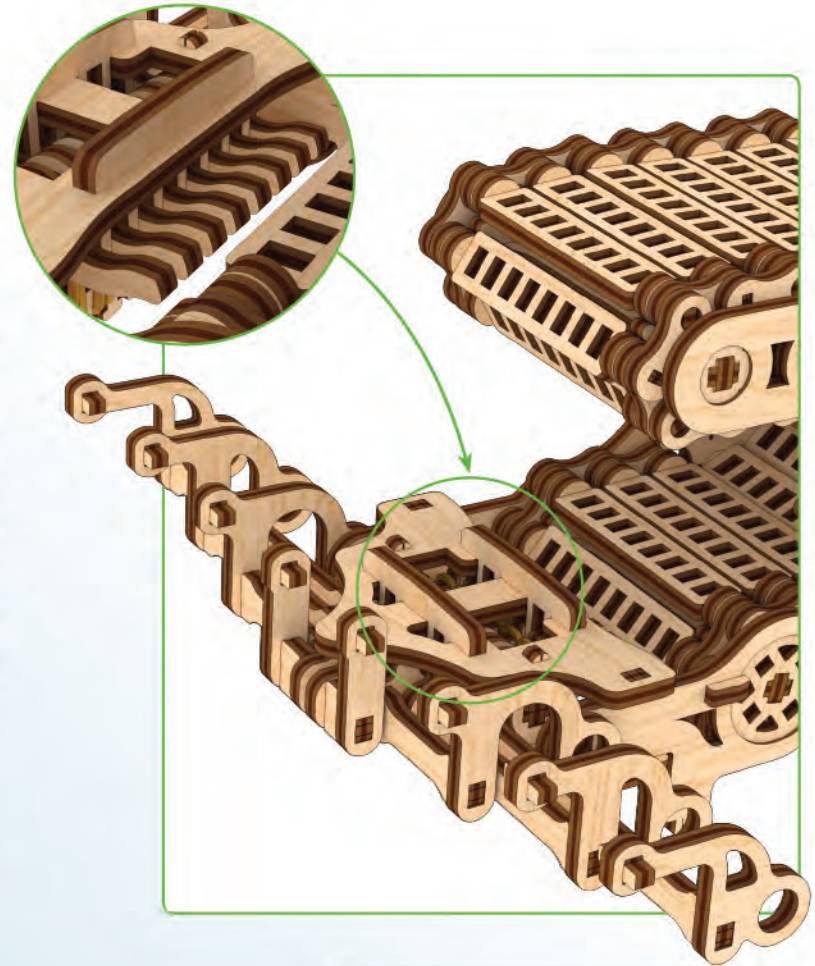
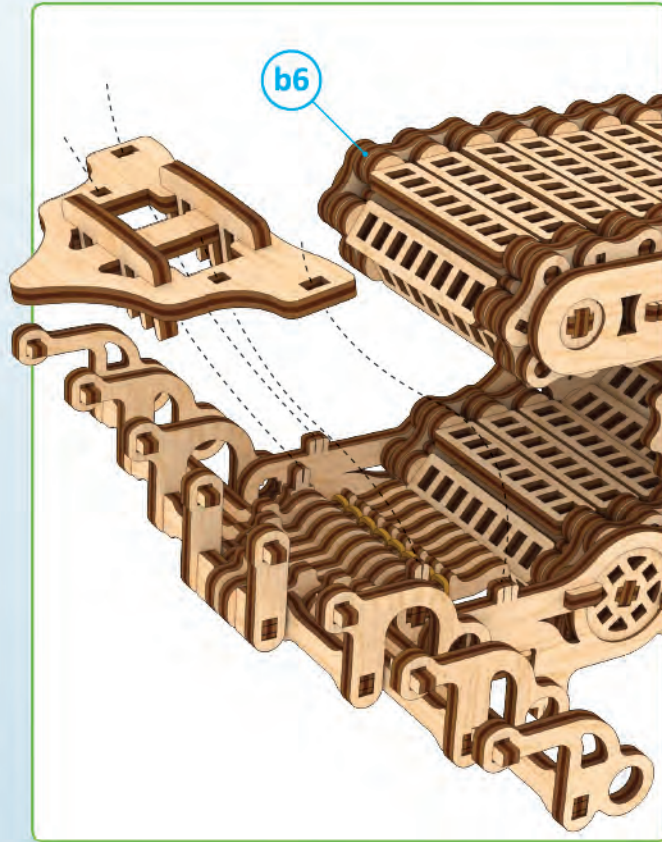

3

3

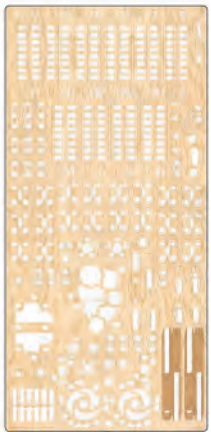
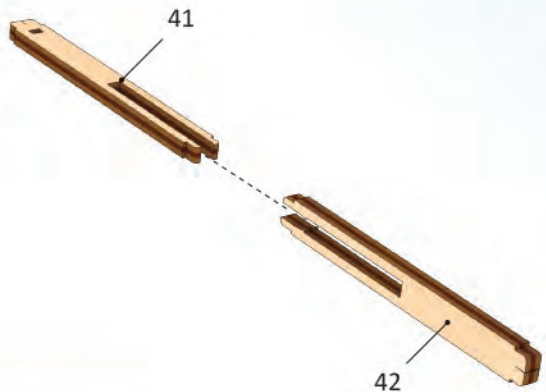

③

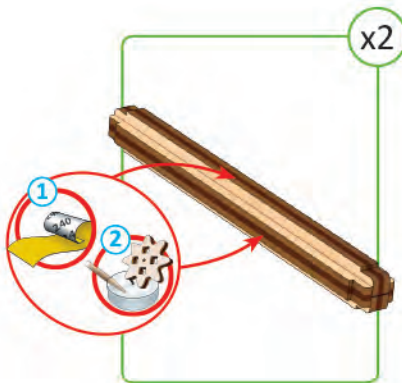

x2

4

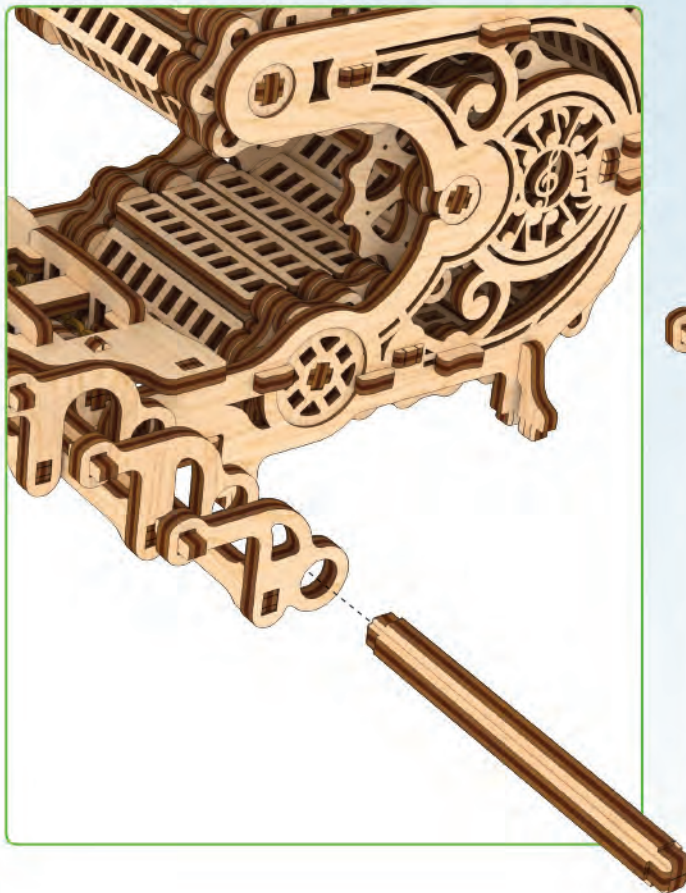

5

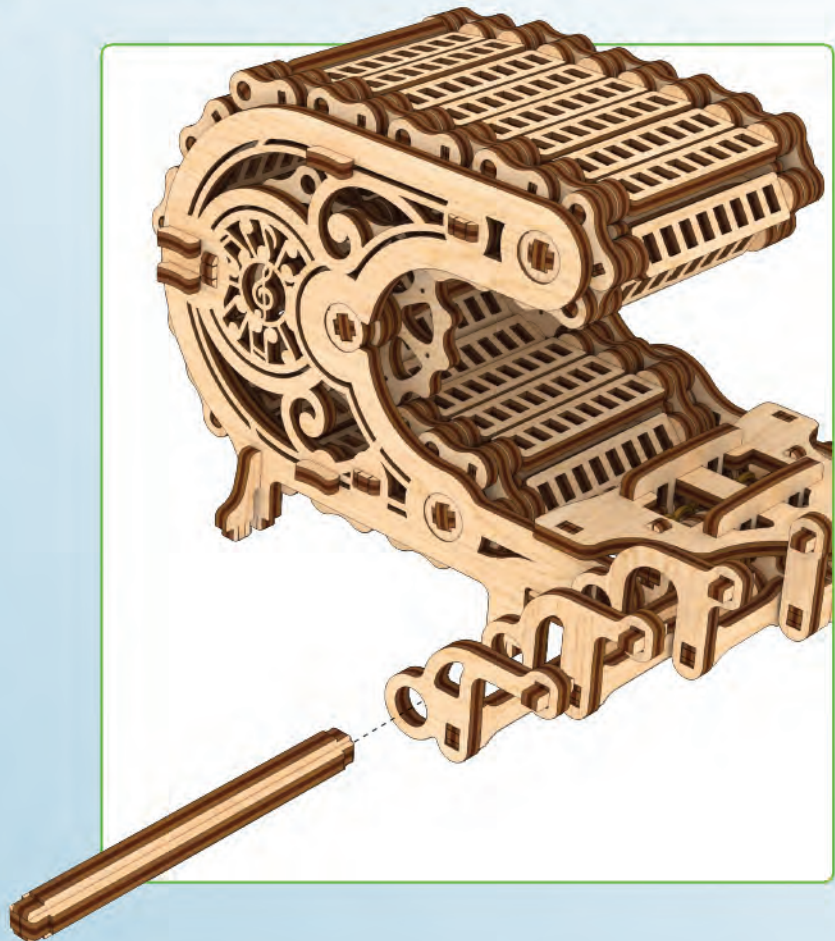

B



1

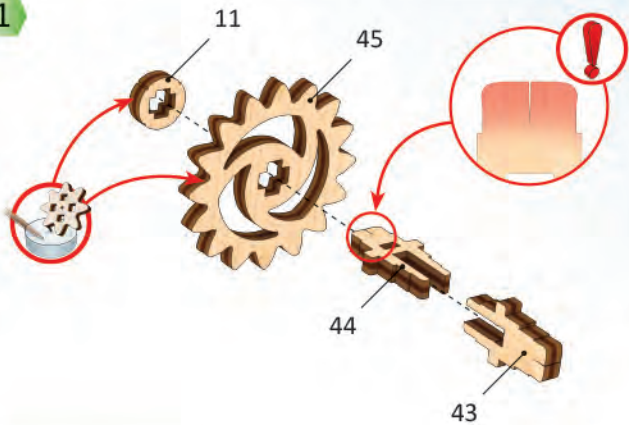

2

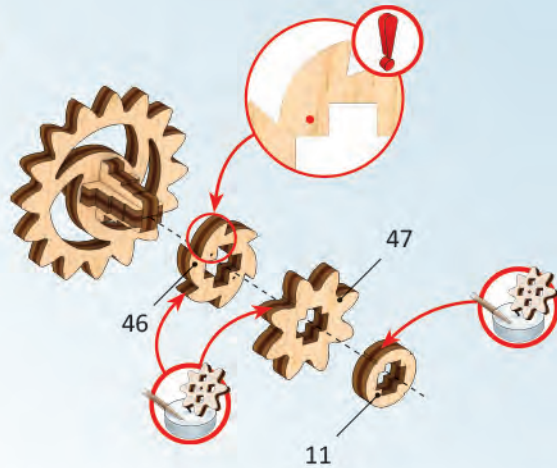

c1

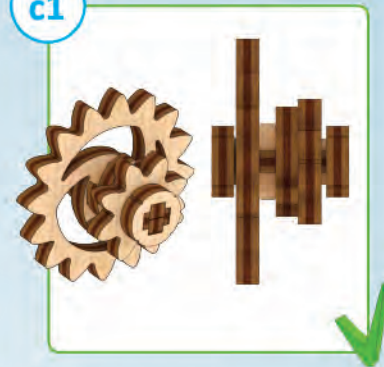

③

1

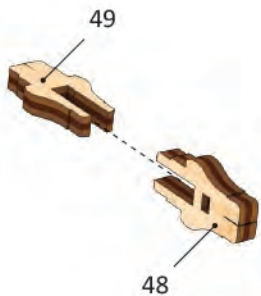

2

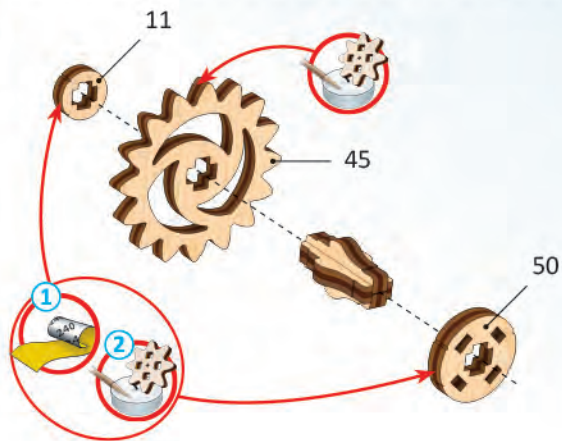

c2

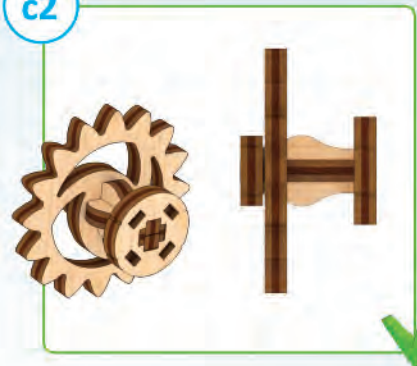

1

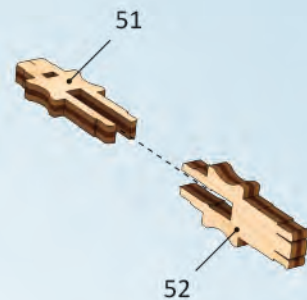

Mechanical models

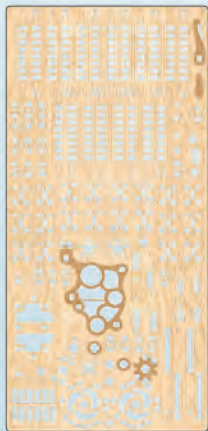

3

2

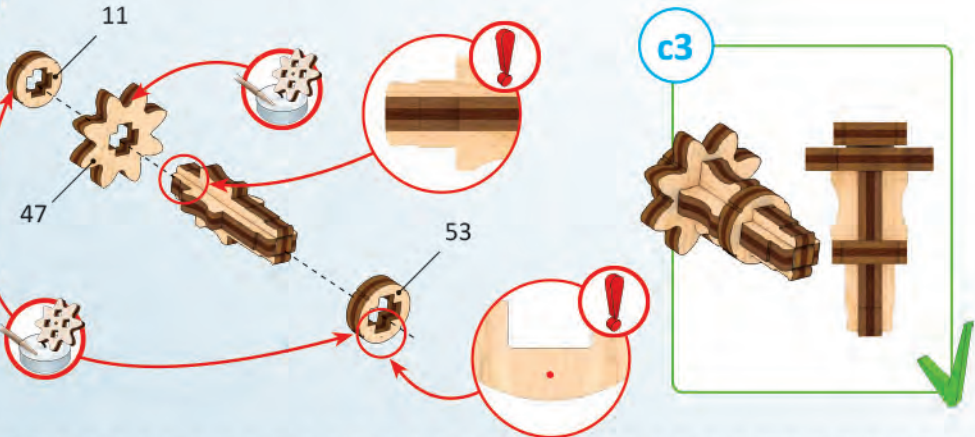

4

1

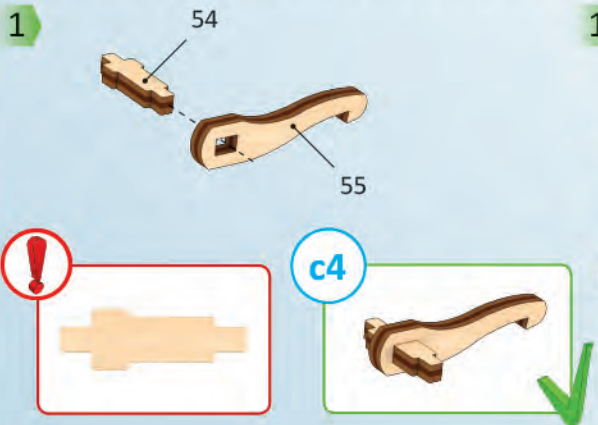

1



2

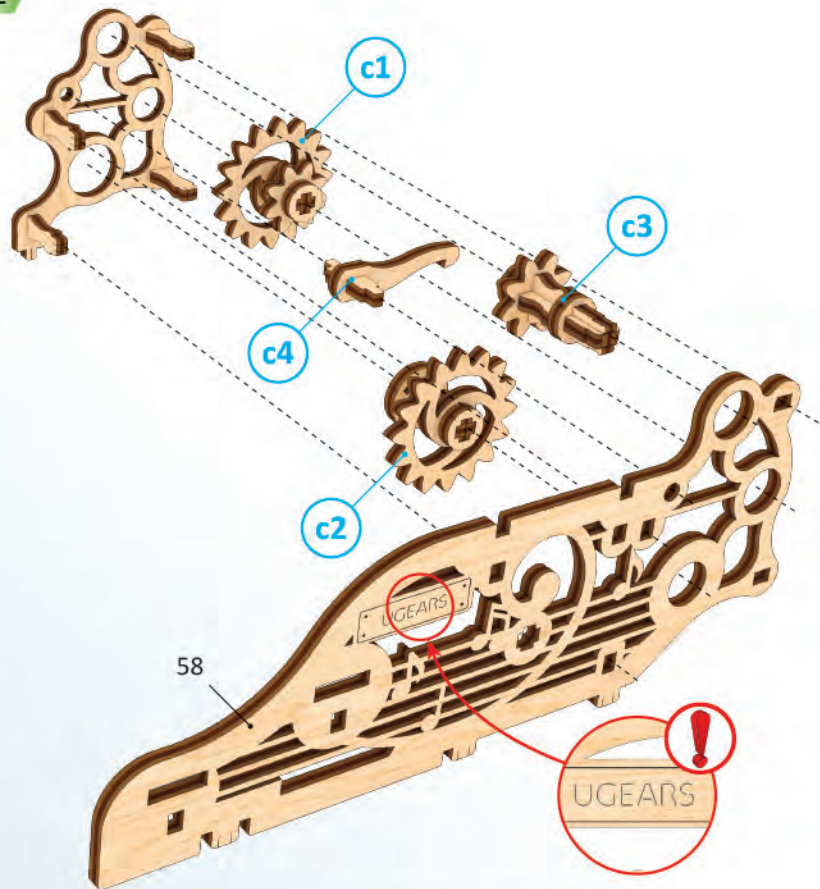

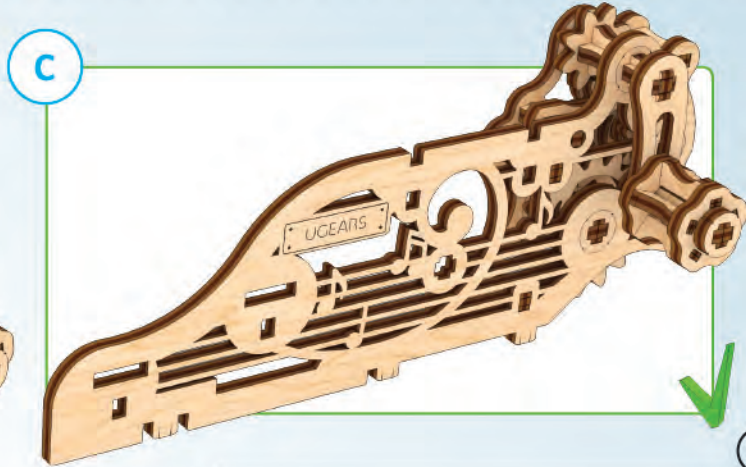
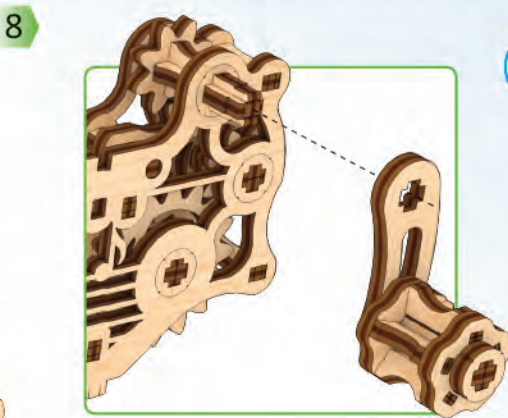
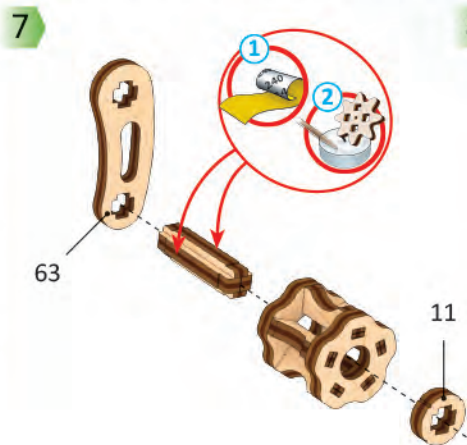
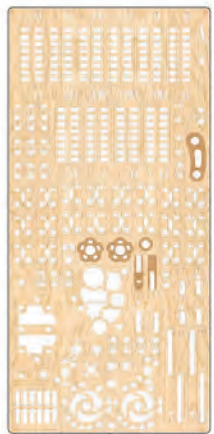
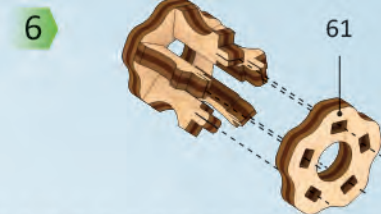
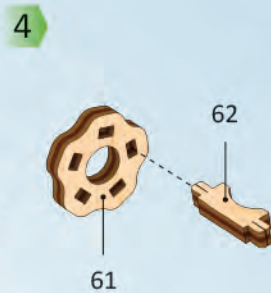
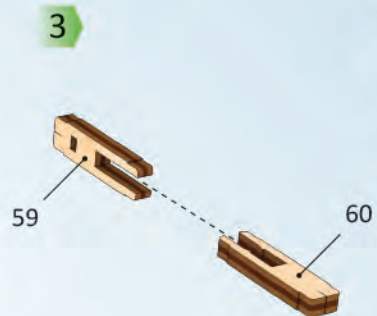
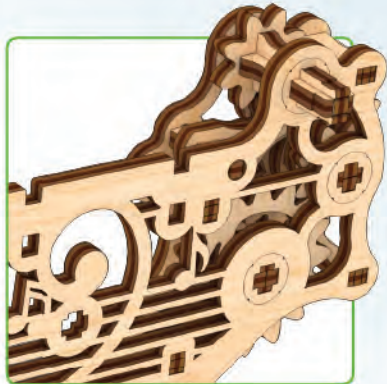
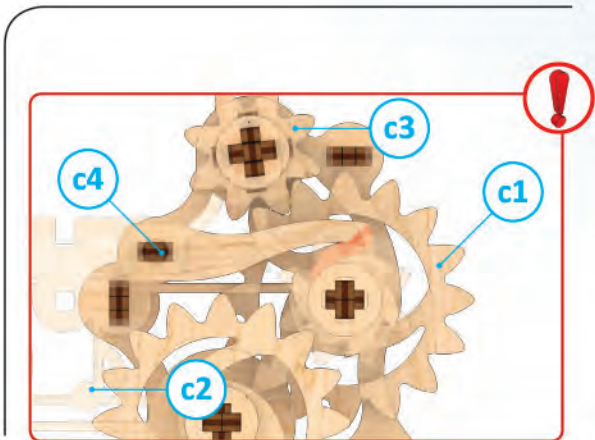

1

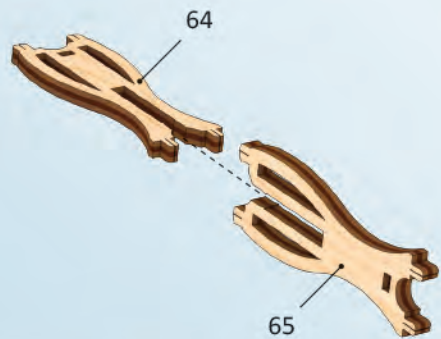

4

2

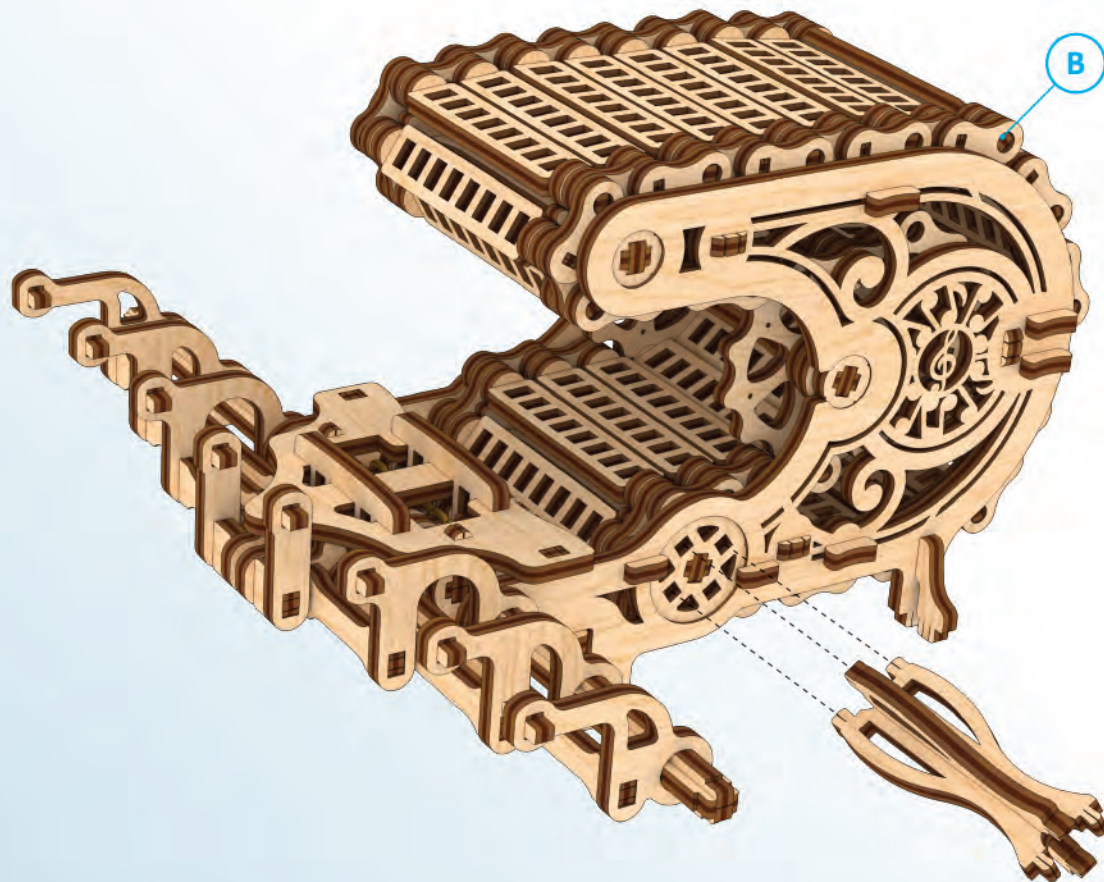

3



D

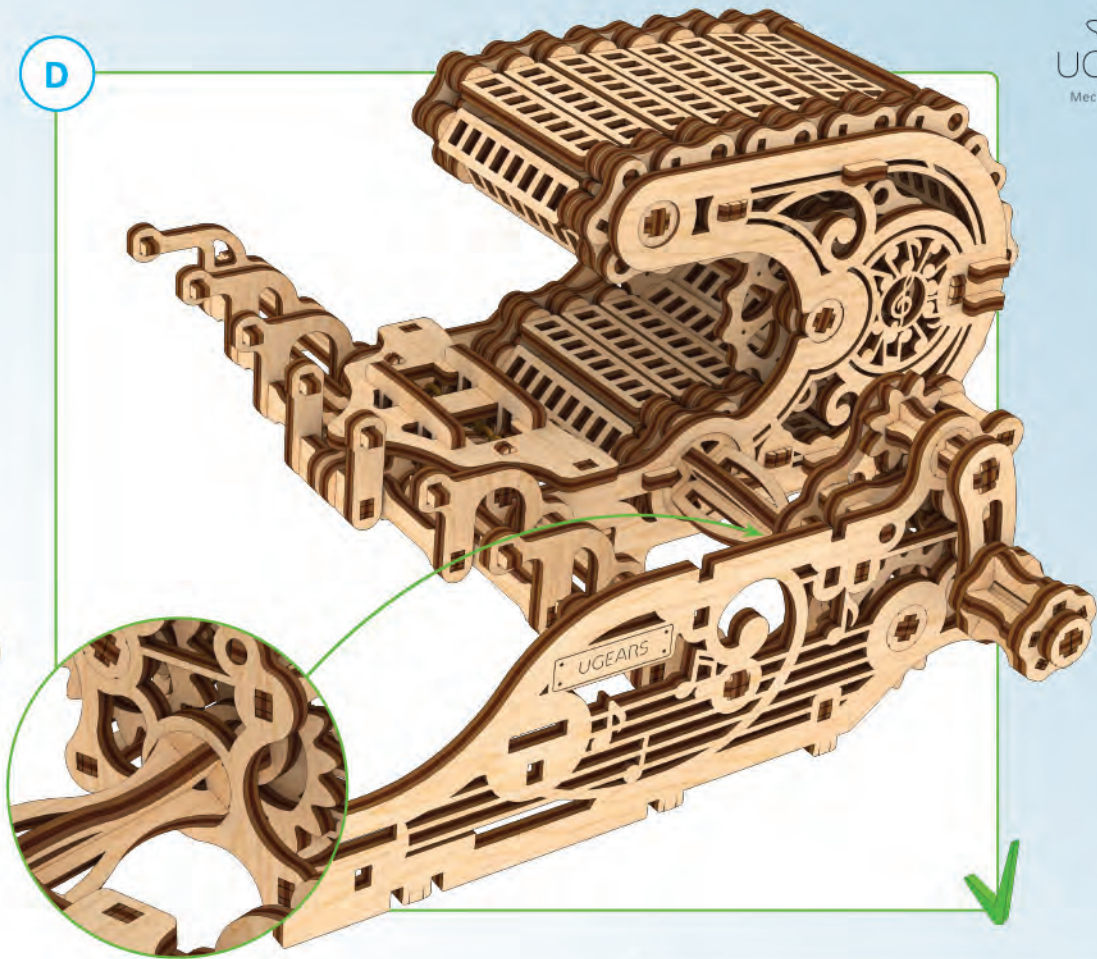

1

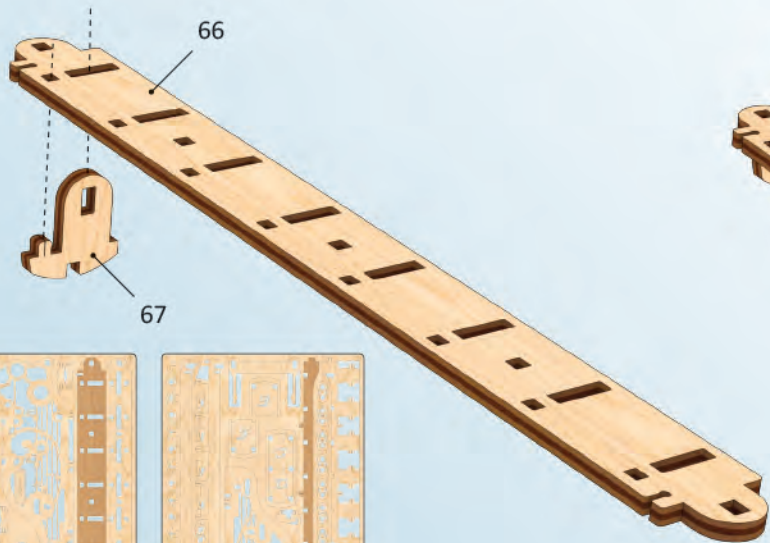

2

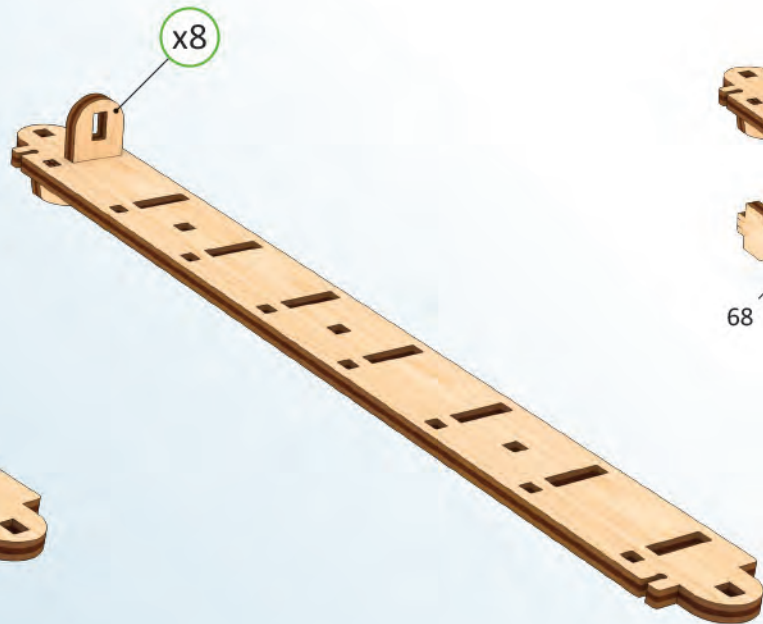

3

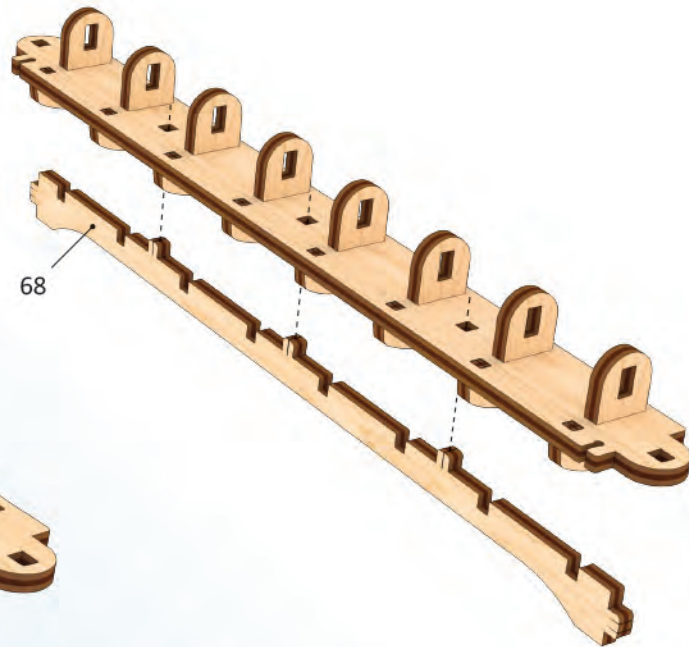

4

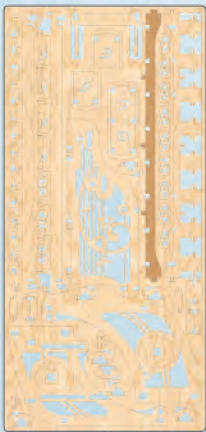

5

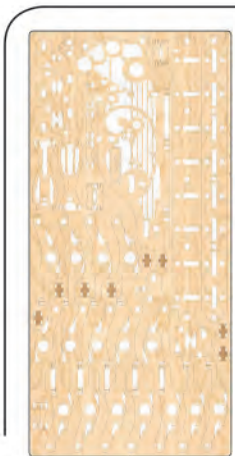

4

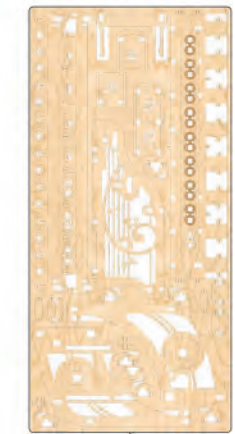

5

4

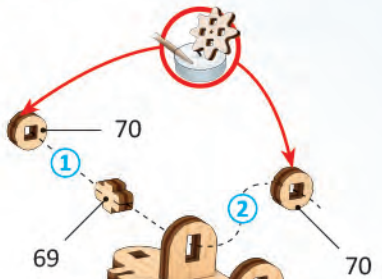

1

70

69

2

70

5



x8

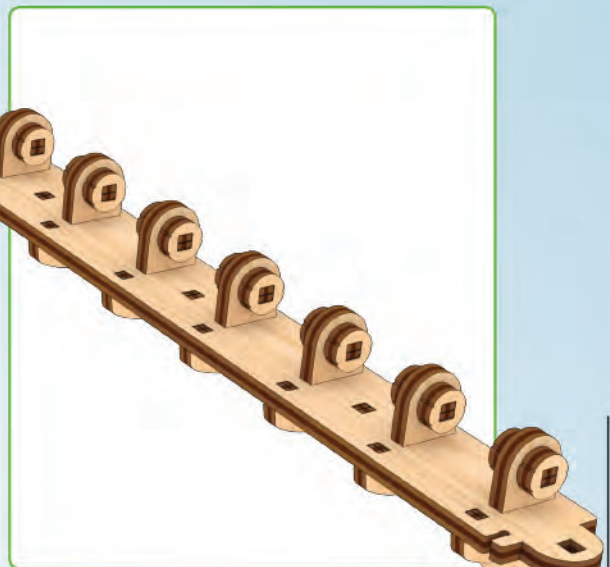

6

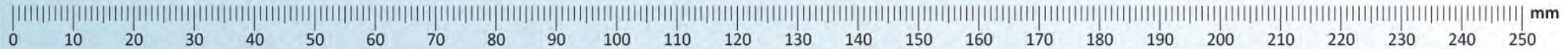
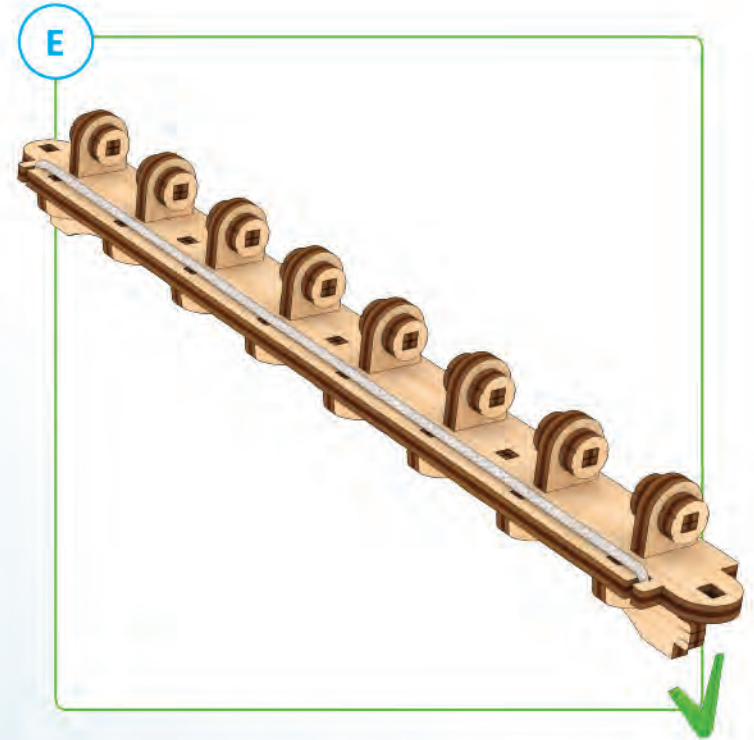
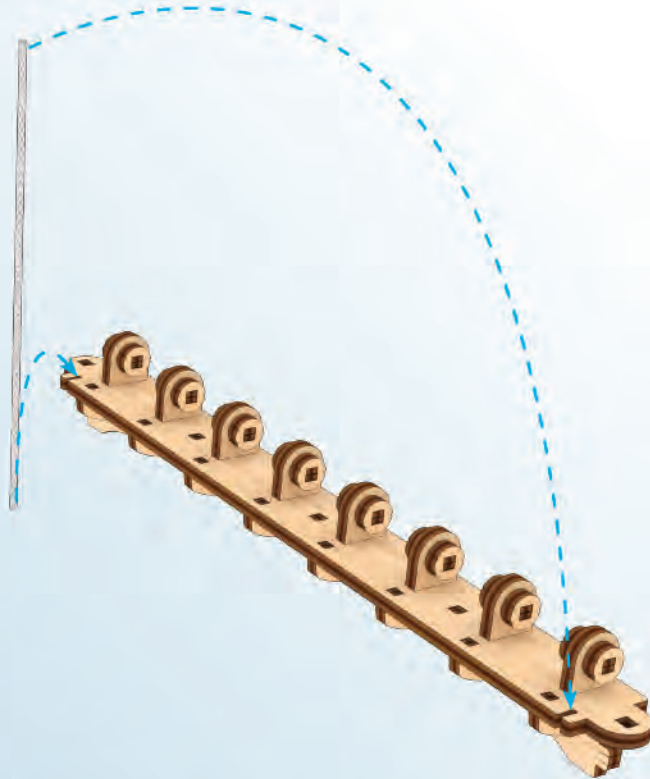
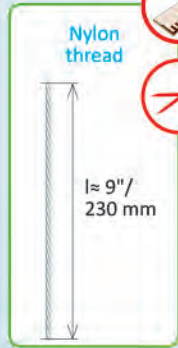

ENG Check size. UKR Перевірте розмір. FRA Vérifiez la dimension. DEU Prüfen Sie die Größe. SPA Compruebe el tamaño. ITA Controllare le dimensioni. JPN サイズをチェックしてください。CHI 測量尺寸 POR Verifique o tamanho. POL Sprawdź rozmiar. KOR 크기를 확인해 주세요.



ENG Cut (rubber-band, thread, etc.). UKR Відріжте (гумку, нитку, тощо). FRA Couper (ruban élastique, fil, etc.). DEU Schneiden (Gummiband, Faden, etc.). SPA Cortar (goma elástica, hilo, etc.). ITA Tagliare (fascia in gomma, filettatura, ecc.). JPN カットしてください。(輪ゴム、糸など)。CHI 切割(橡皮筋, 线等)。POR Corte (elástico, fio, etc.). POL Utnij (gumkę, nitkę, itd.). KOR 절단(고무밴드, 이쑤시개 등)

1

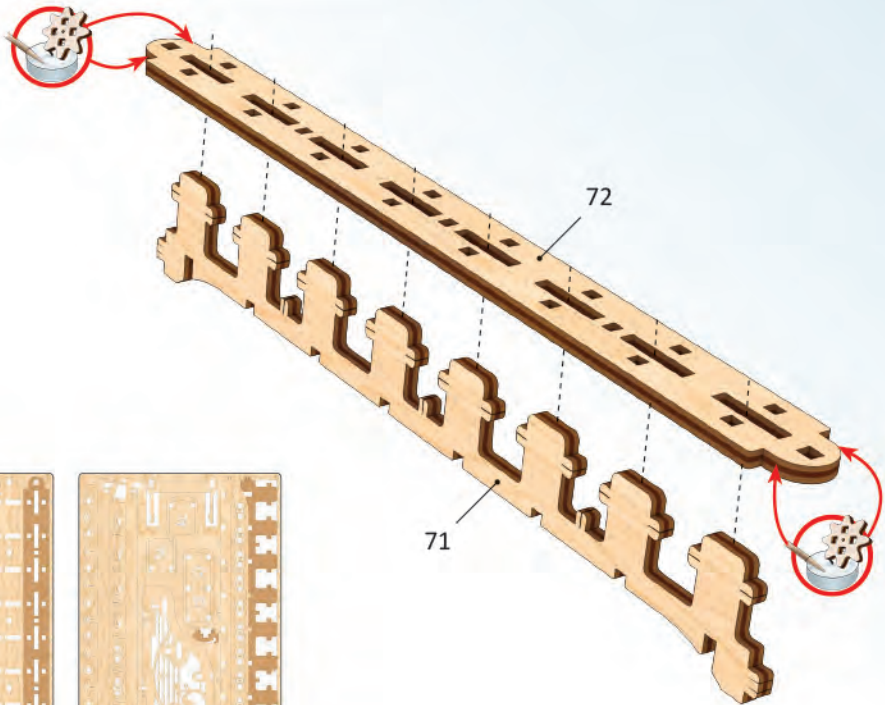

2



3

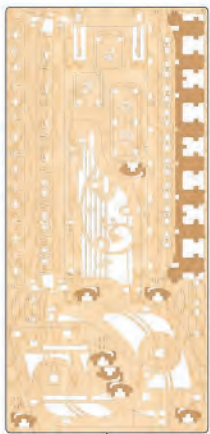
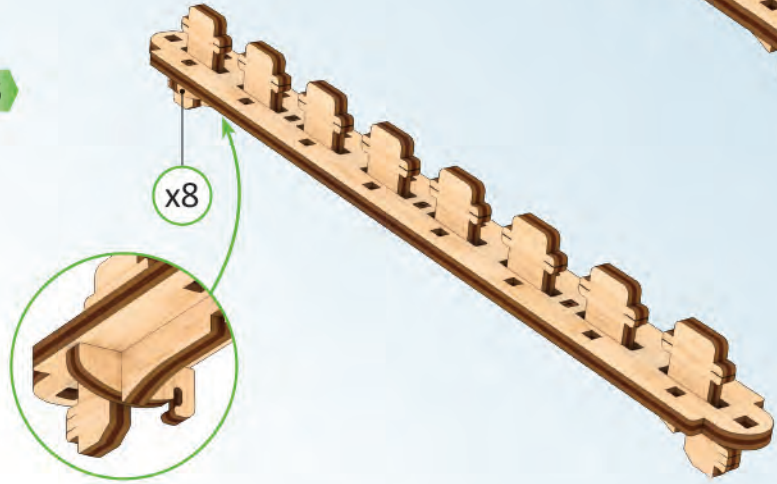

4

5

4

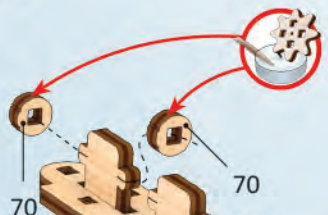

5

5

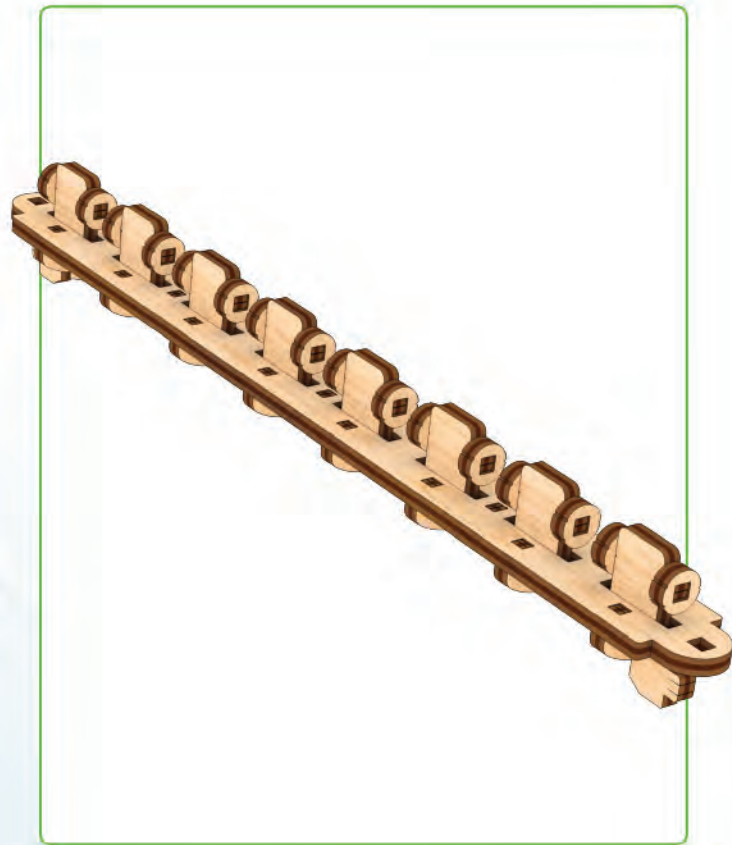
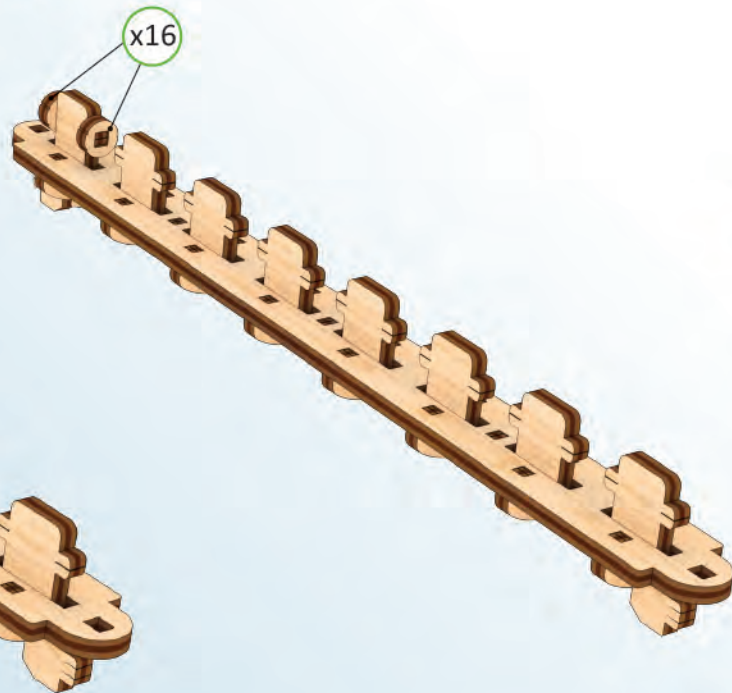

6

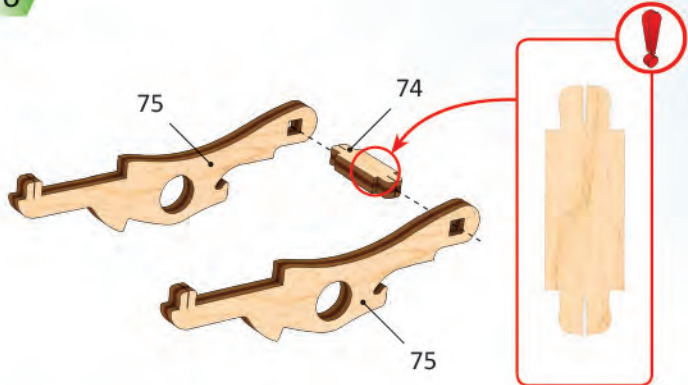

7

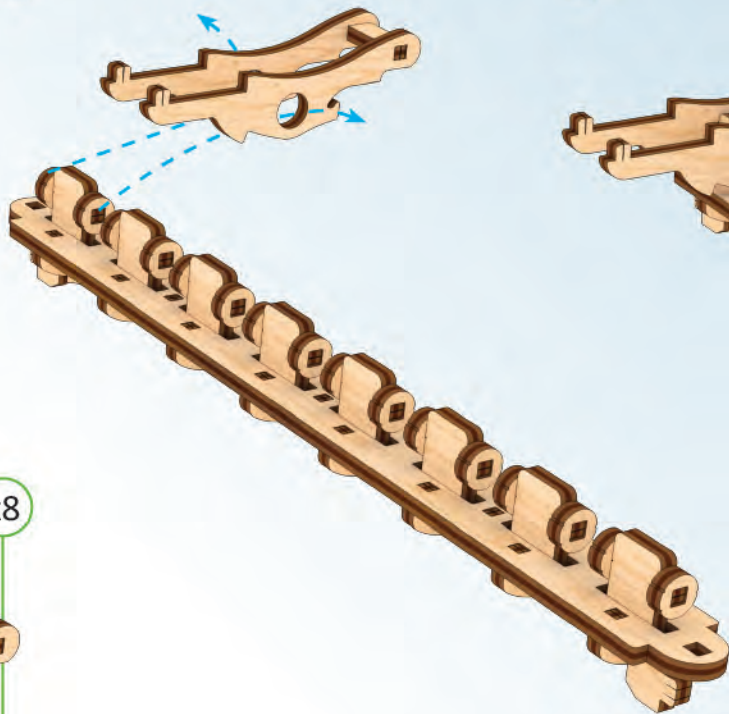

8

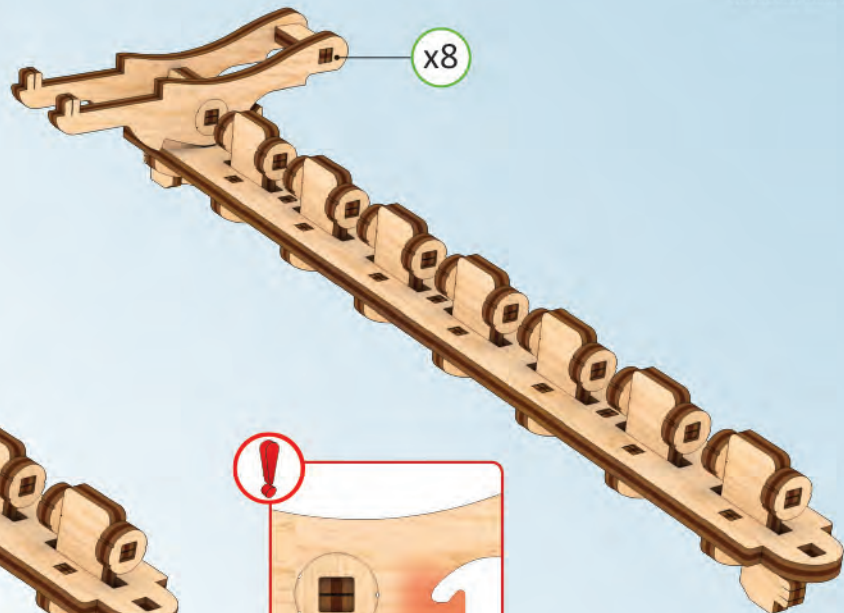

4



5



x8

Mechanical models

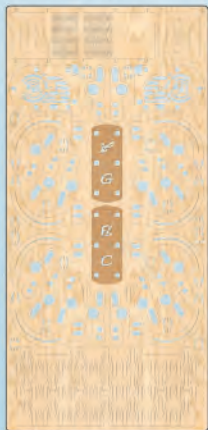

9

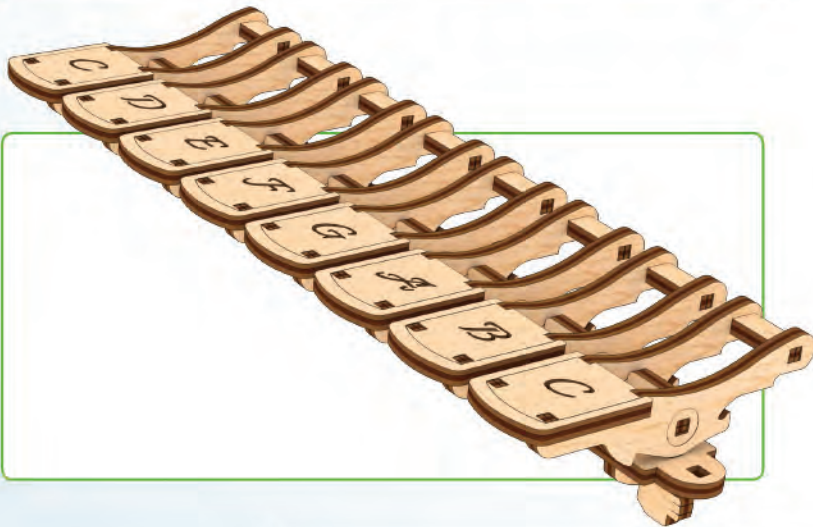
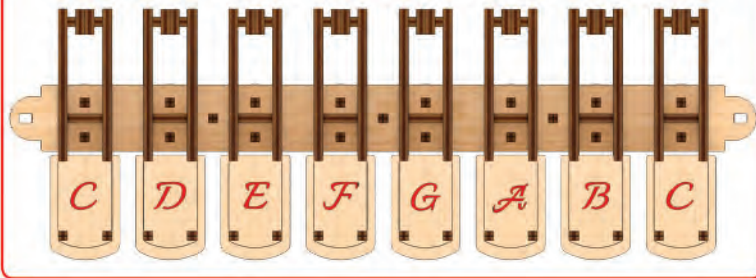
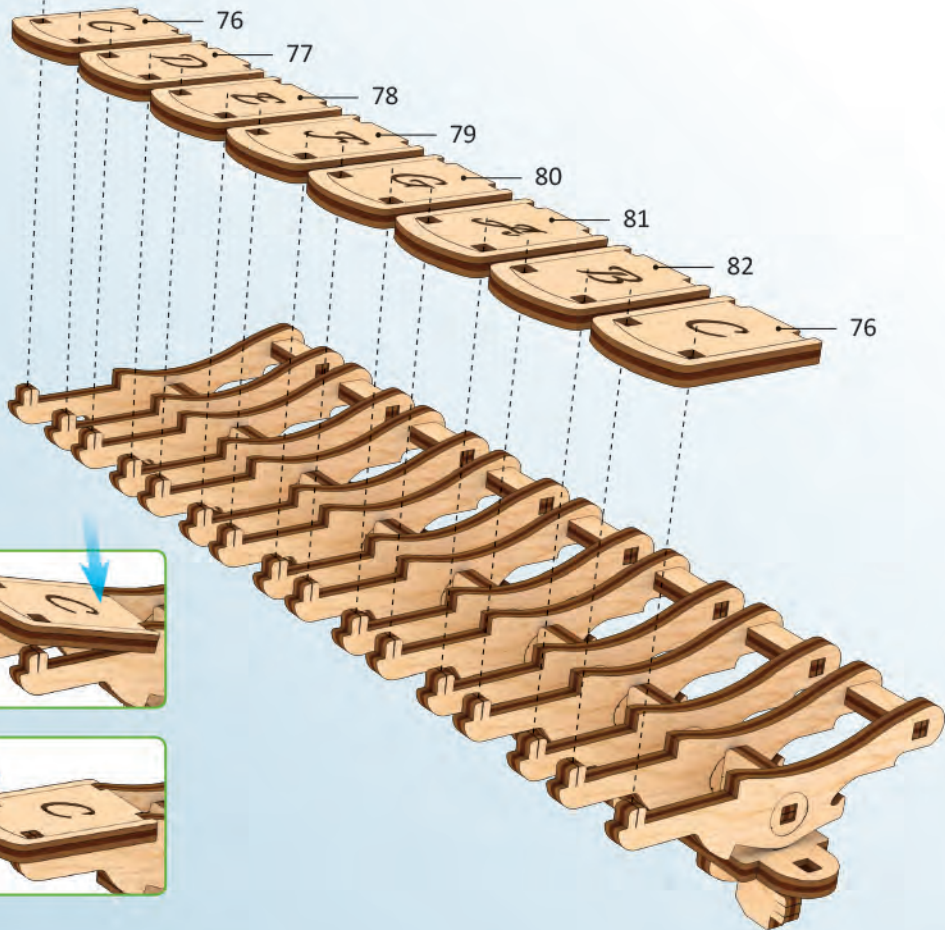

10

$h \approx 0.06'' / 1,5 \text{ mm}$
 $D \approx 0.4'' / 10 \text{ mm}$

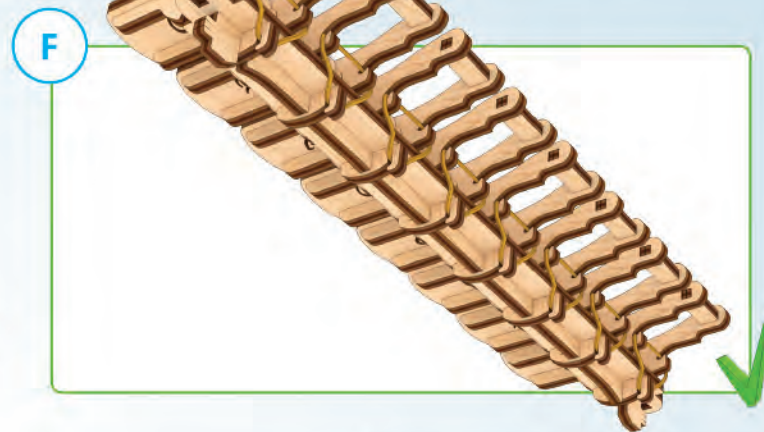
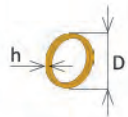

1

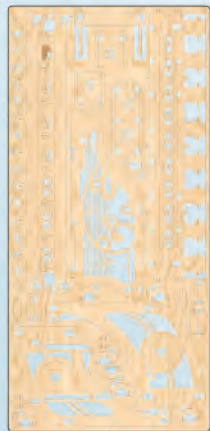

5

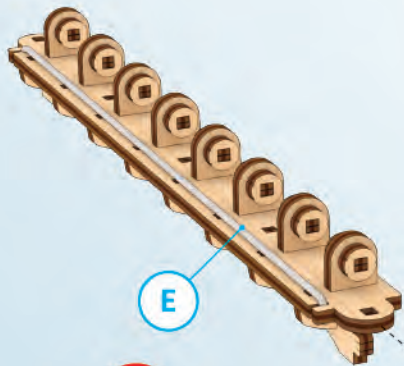

E

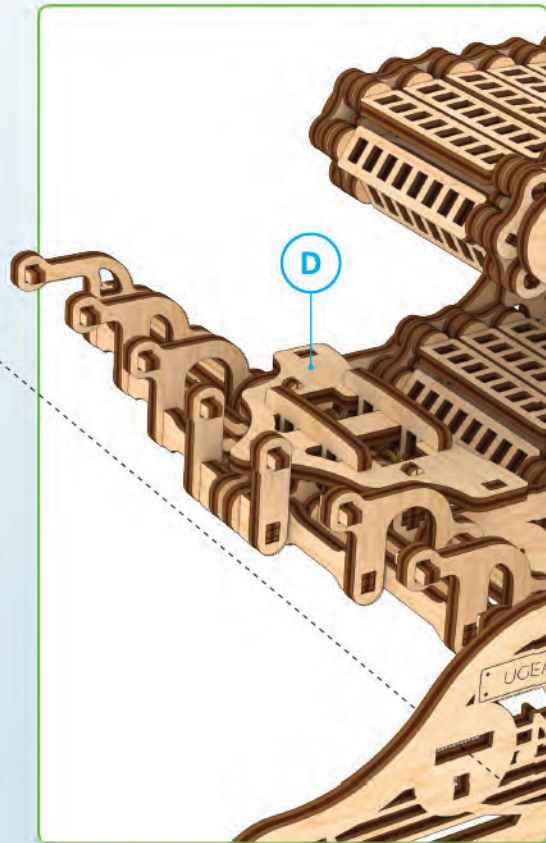
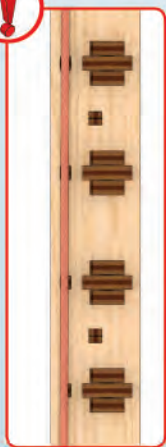

D

2



83

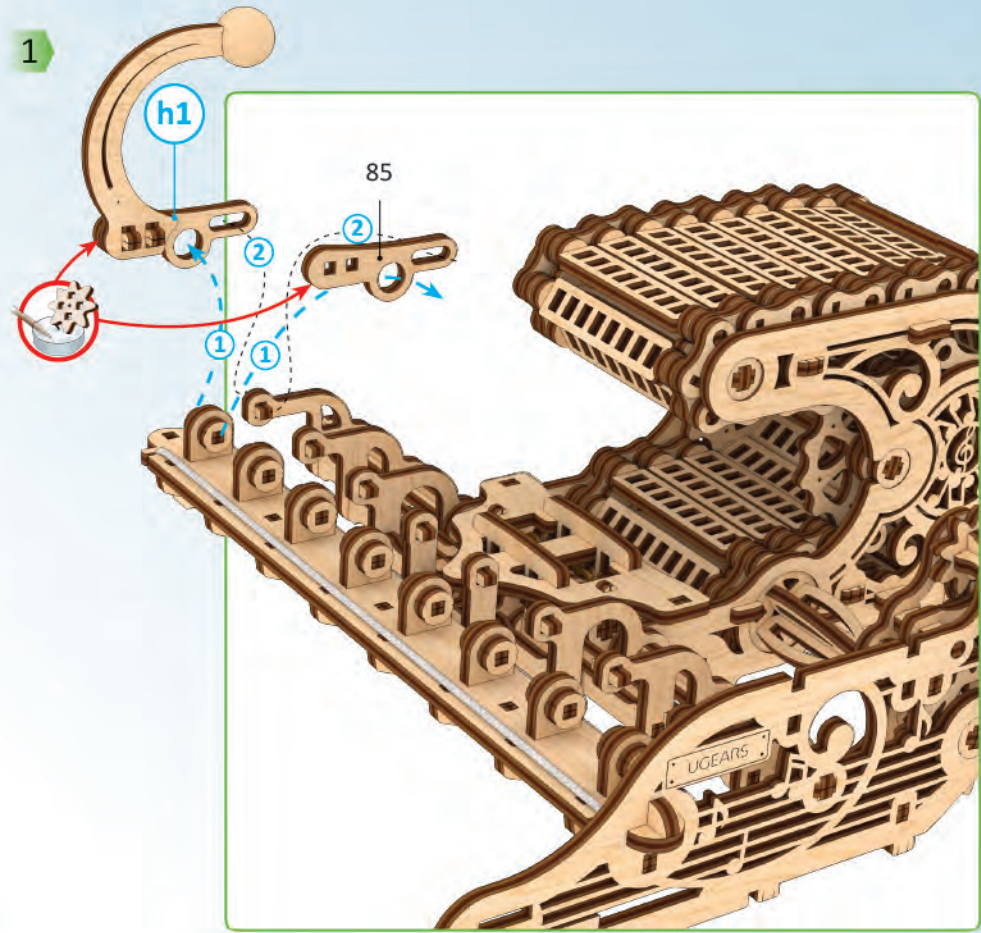
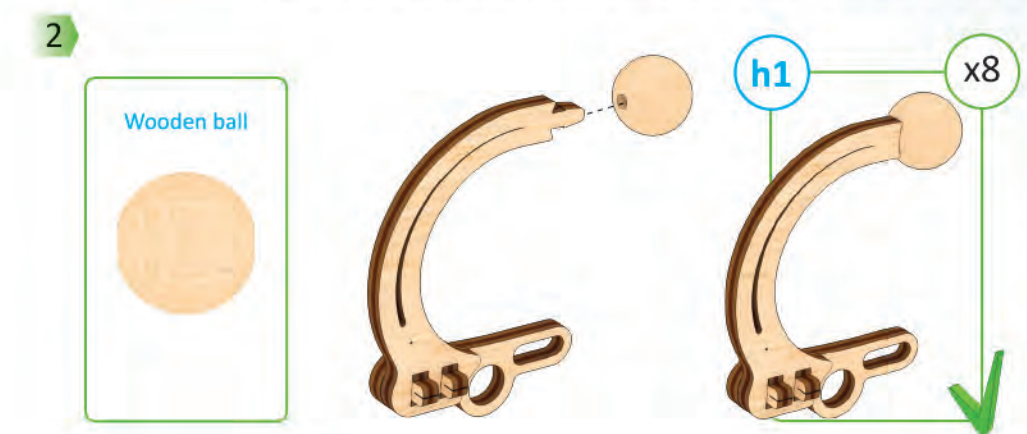
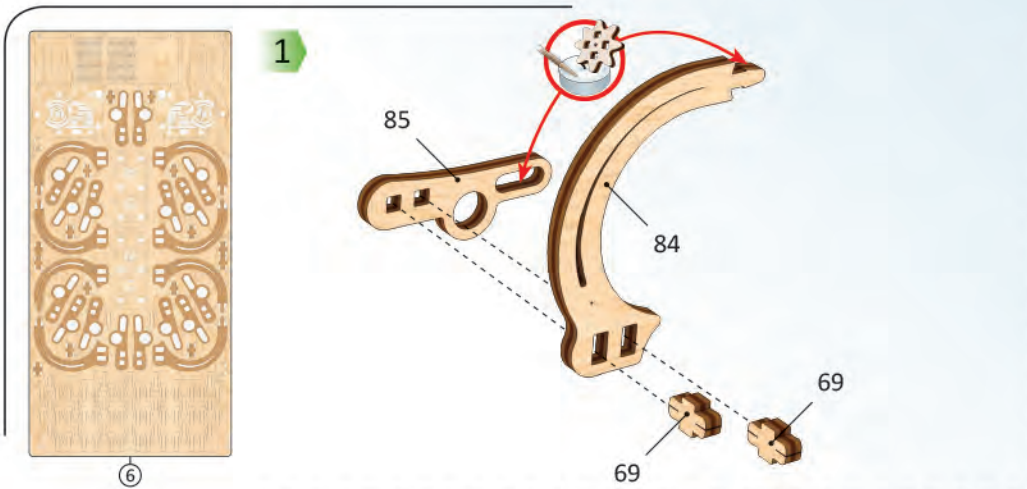

2

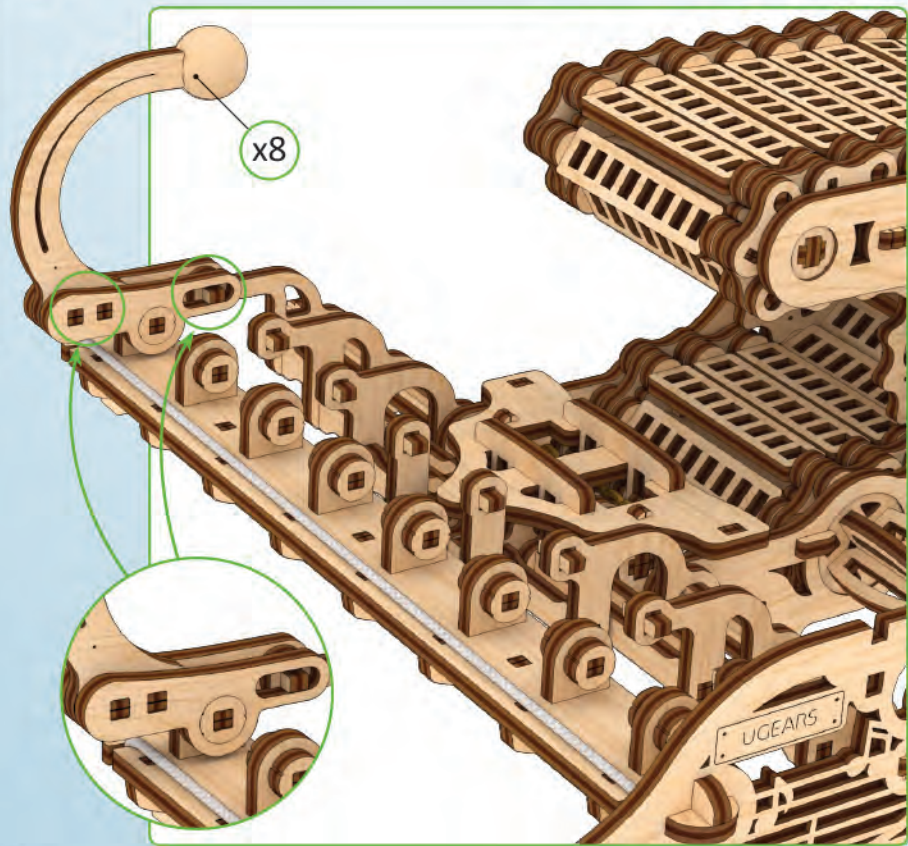

3

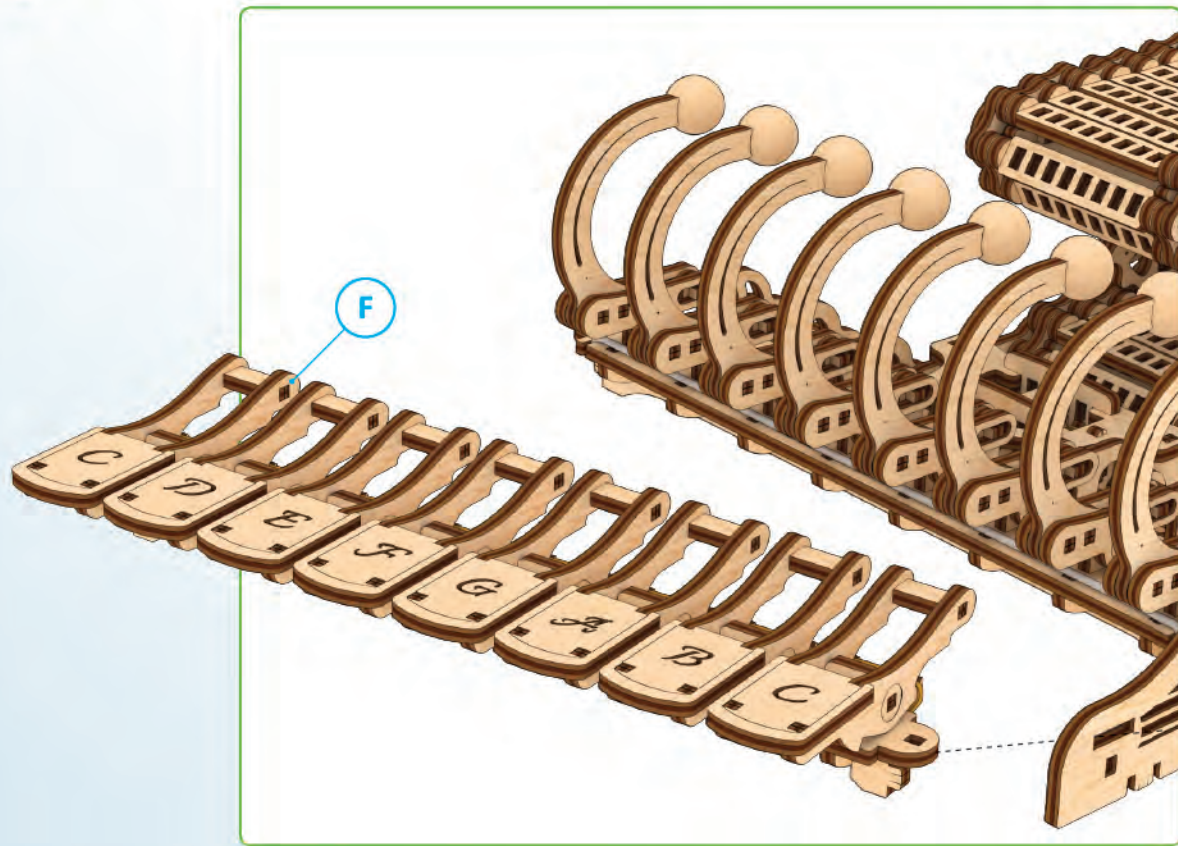



4

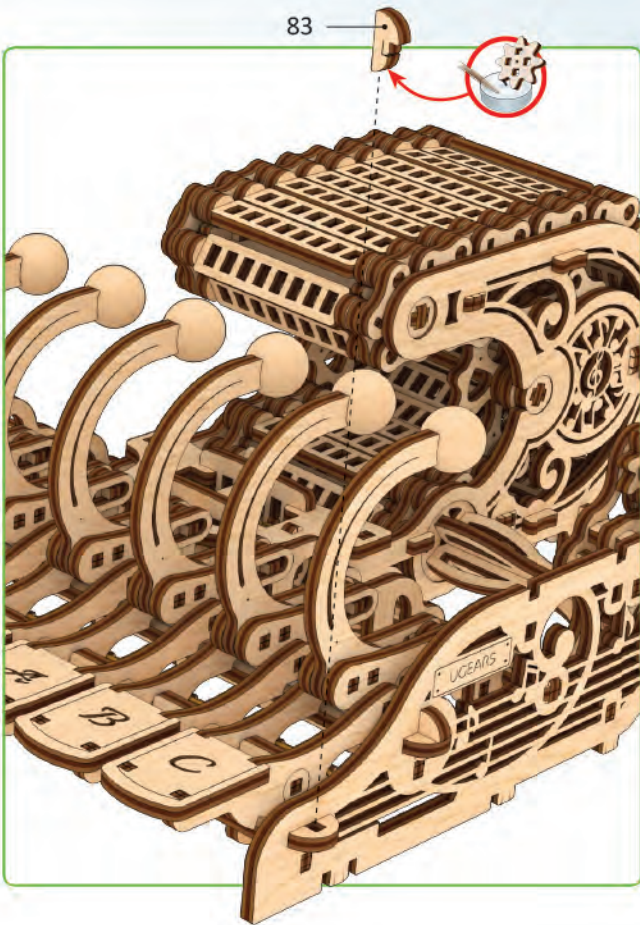

H

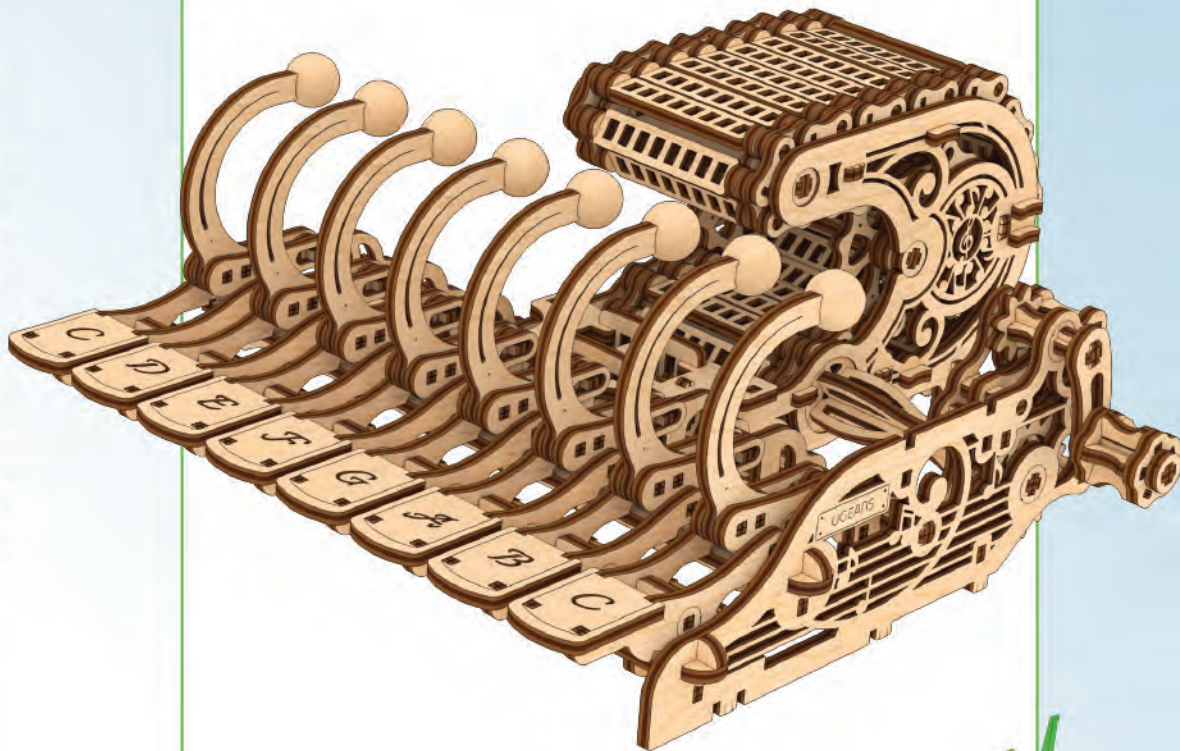

1

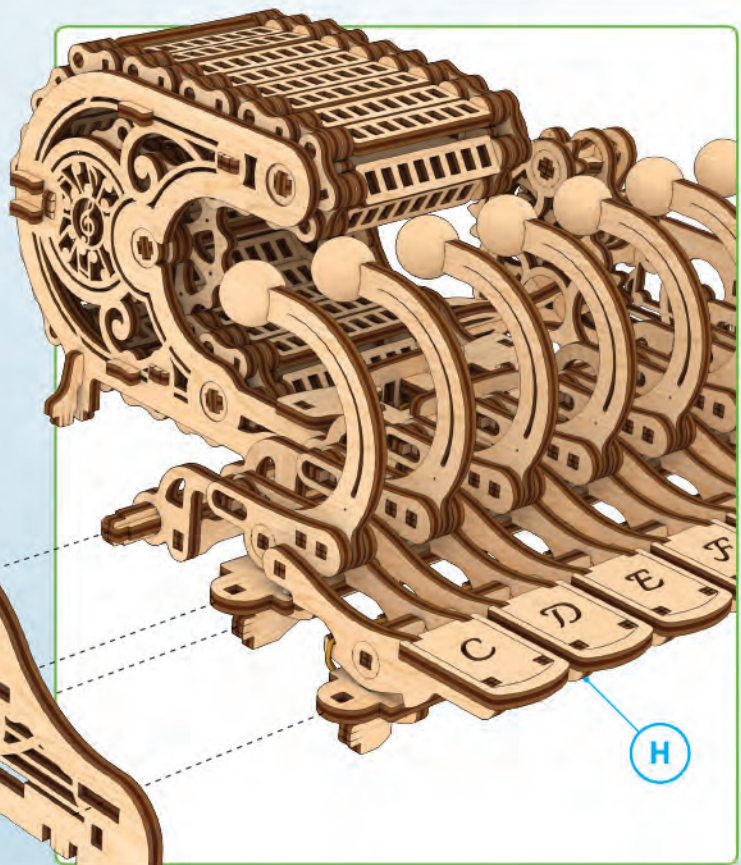
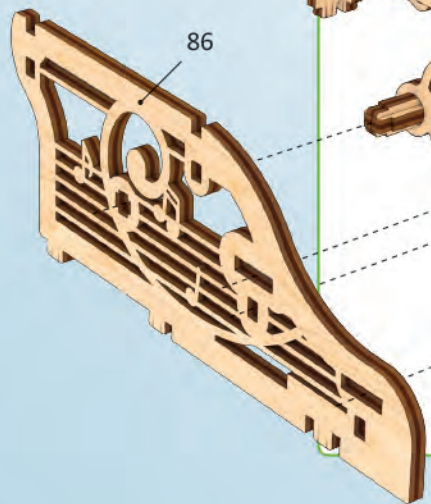

2

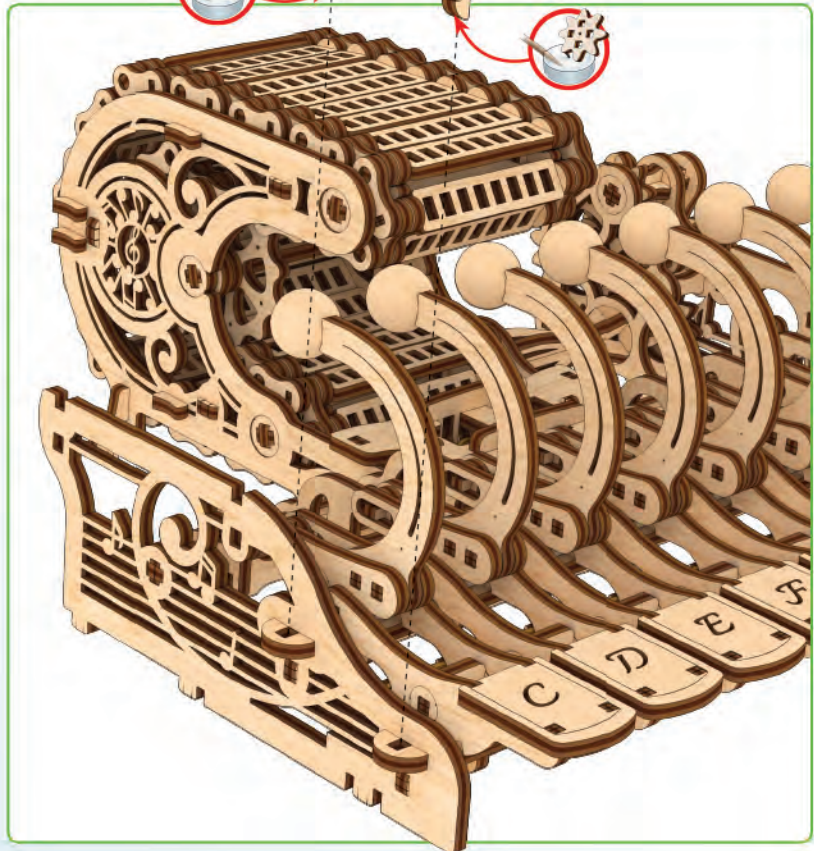
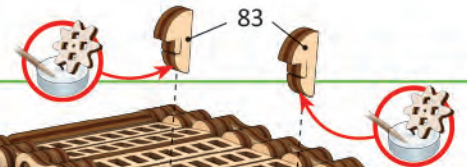

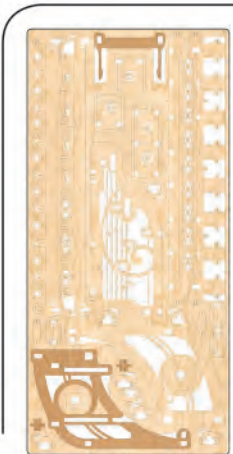

5

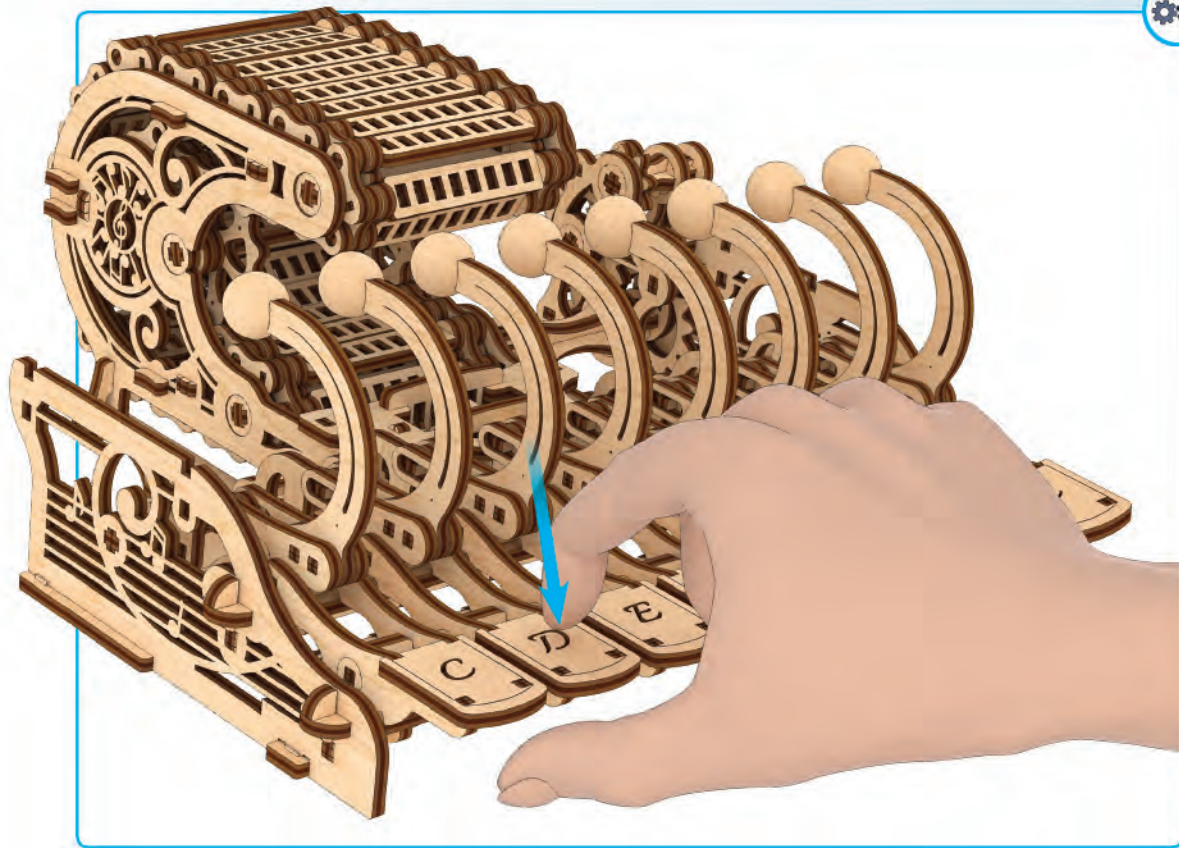

3

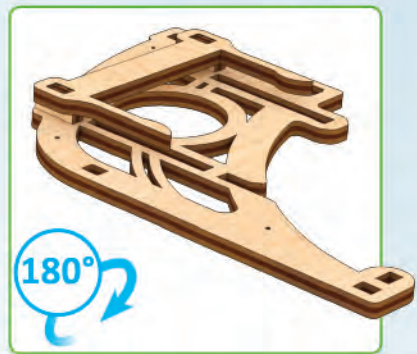
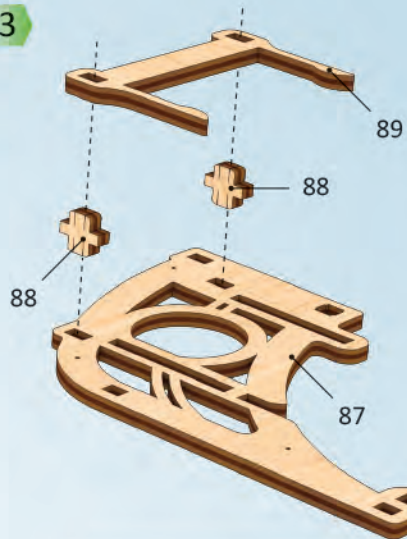

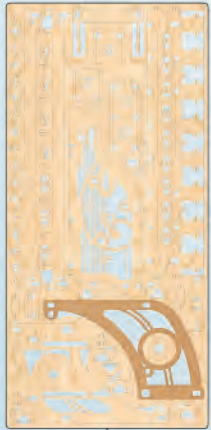

4

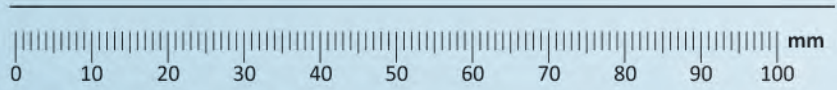
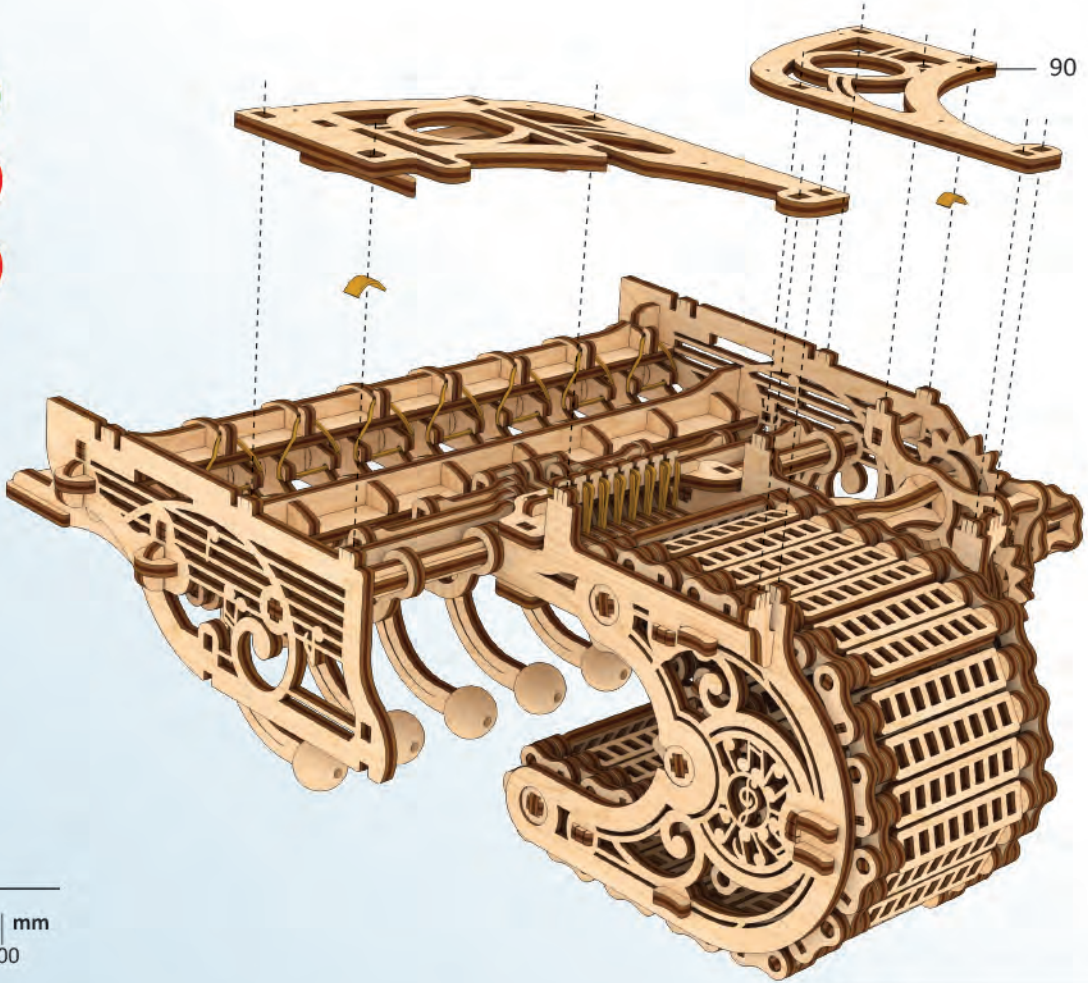
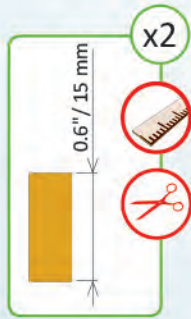
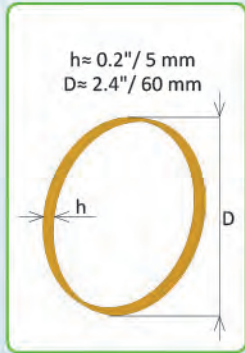



5

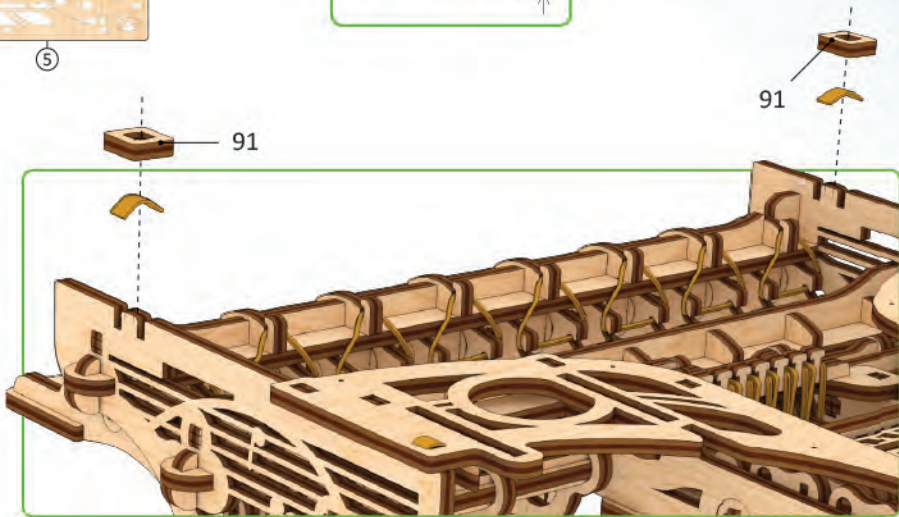
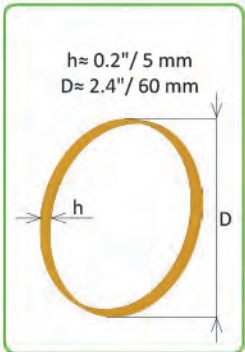

1

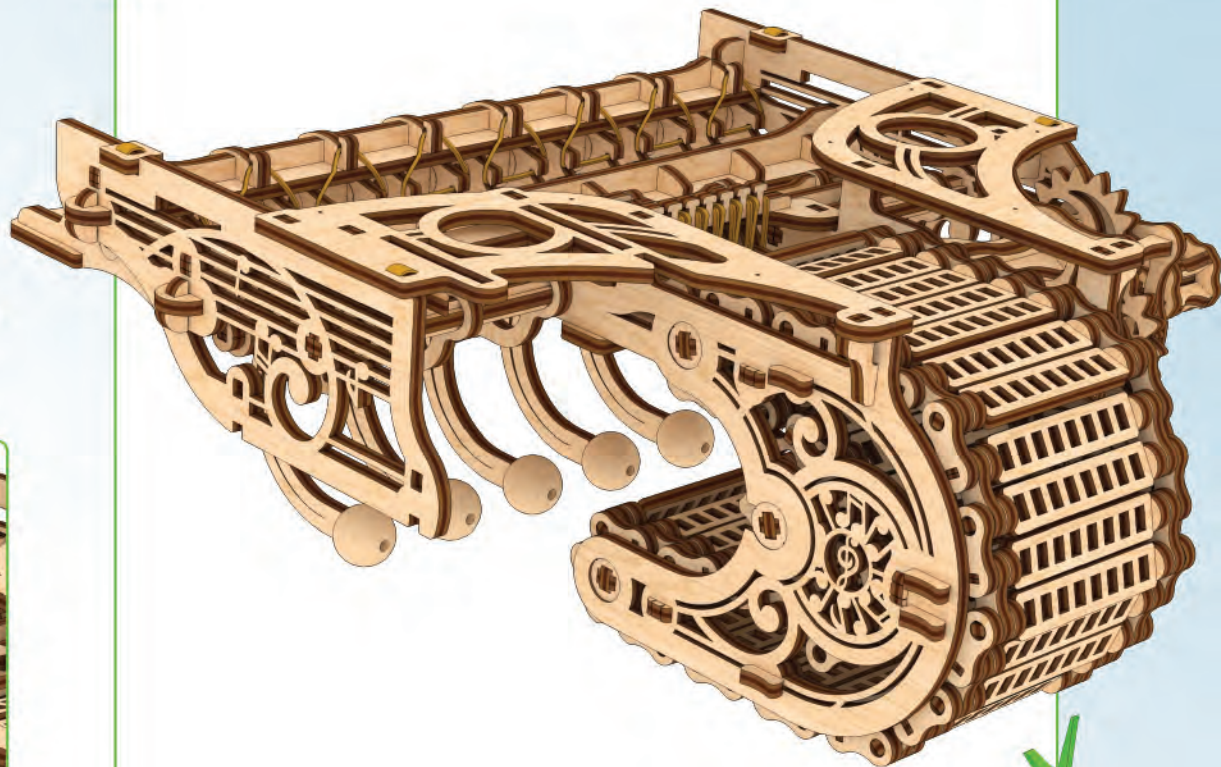

1

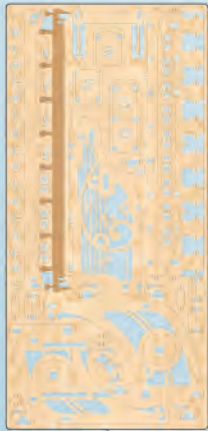
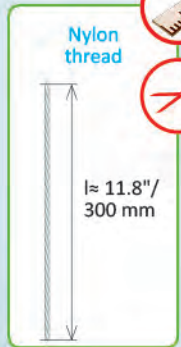

48



92

2

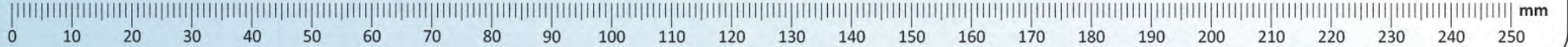
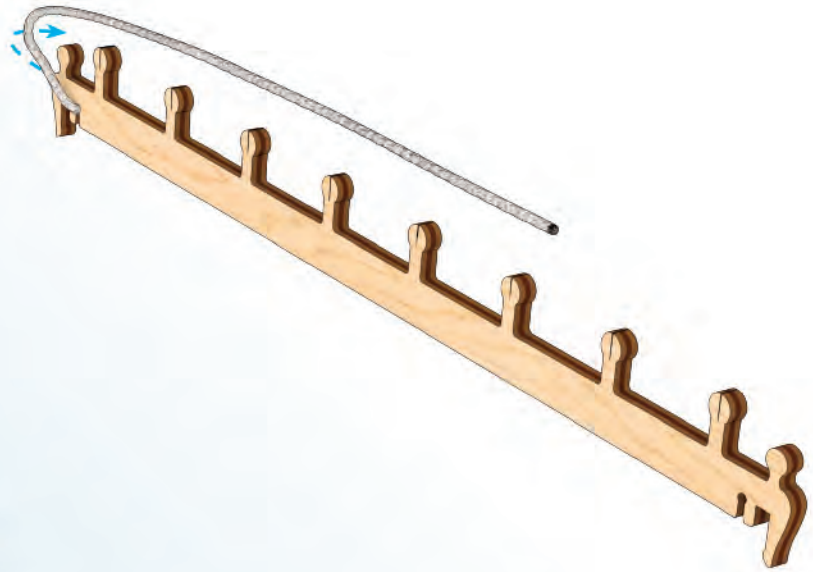

3

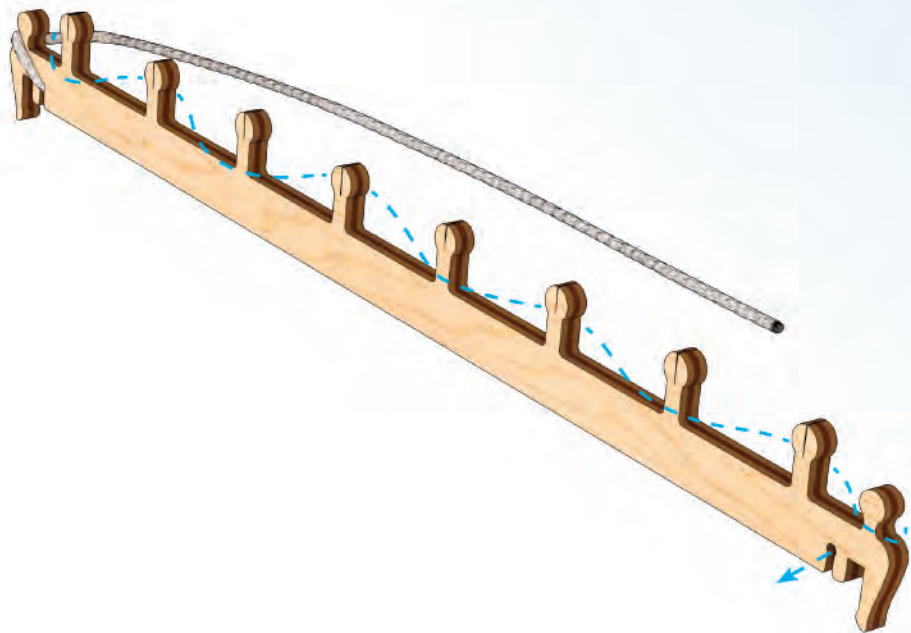

j1

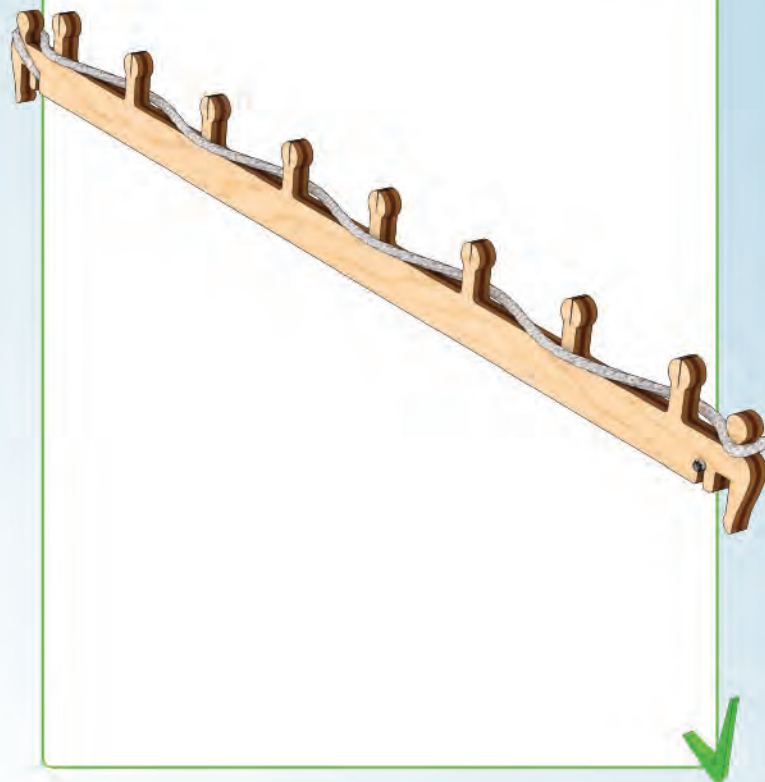

Mechanical models

1

Nylon thread

l ≈ 11.8" / 300 mm



50

5

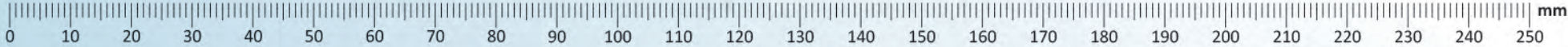

2

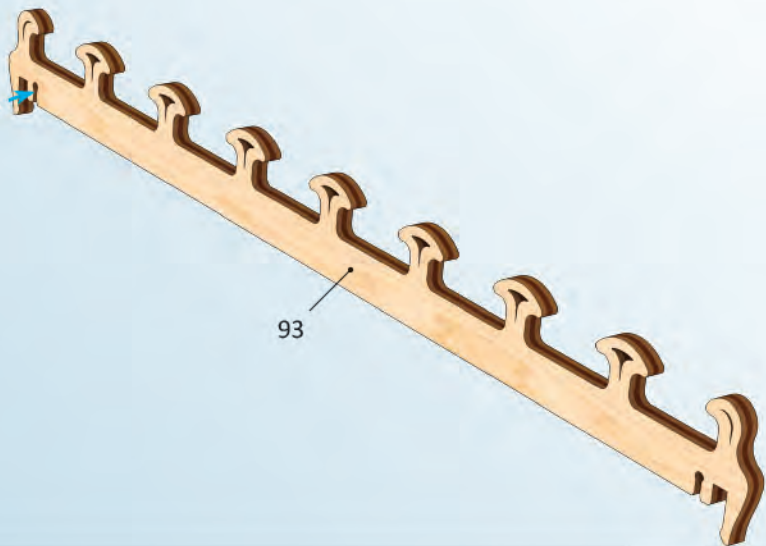

93

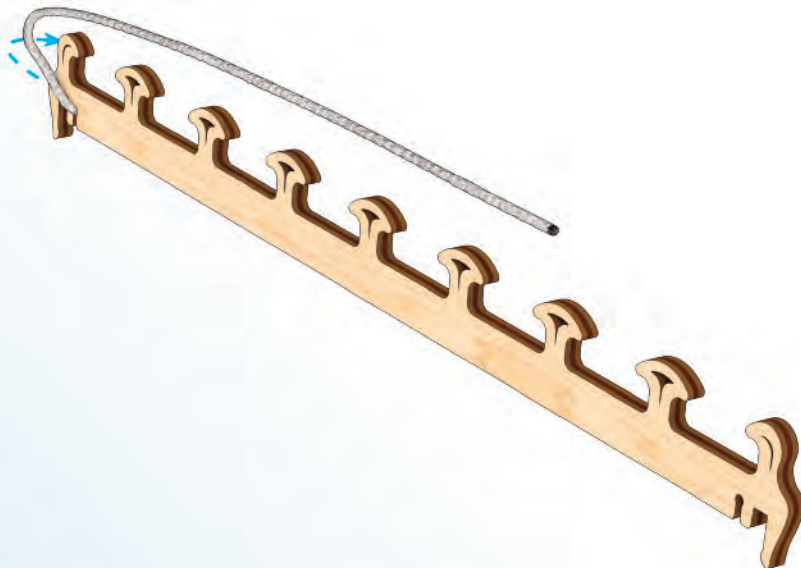

3

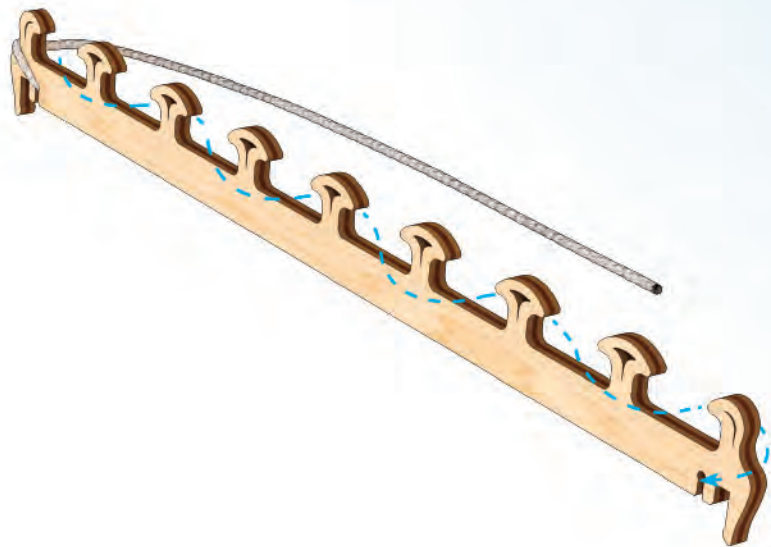

j2

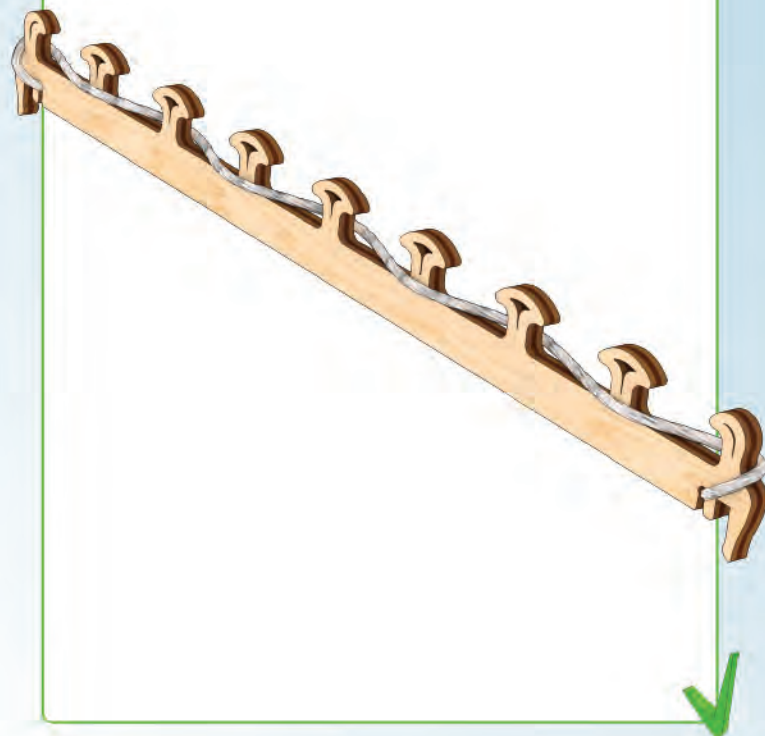

1

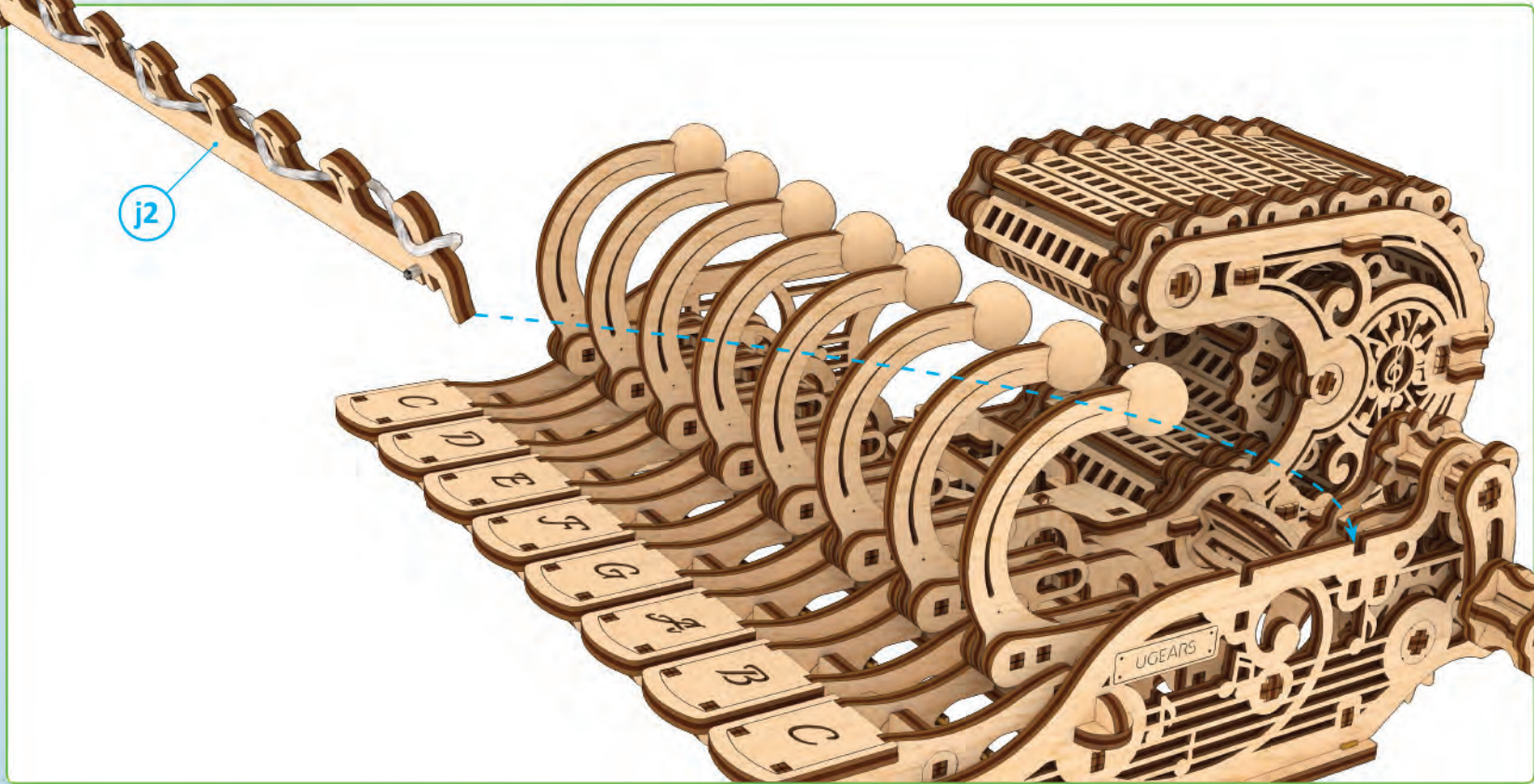

2

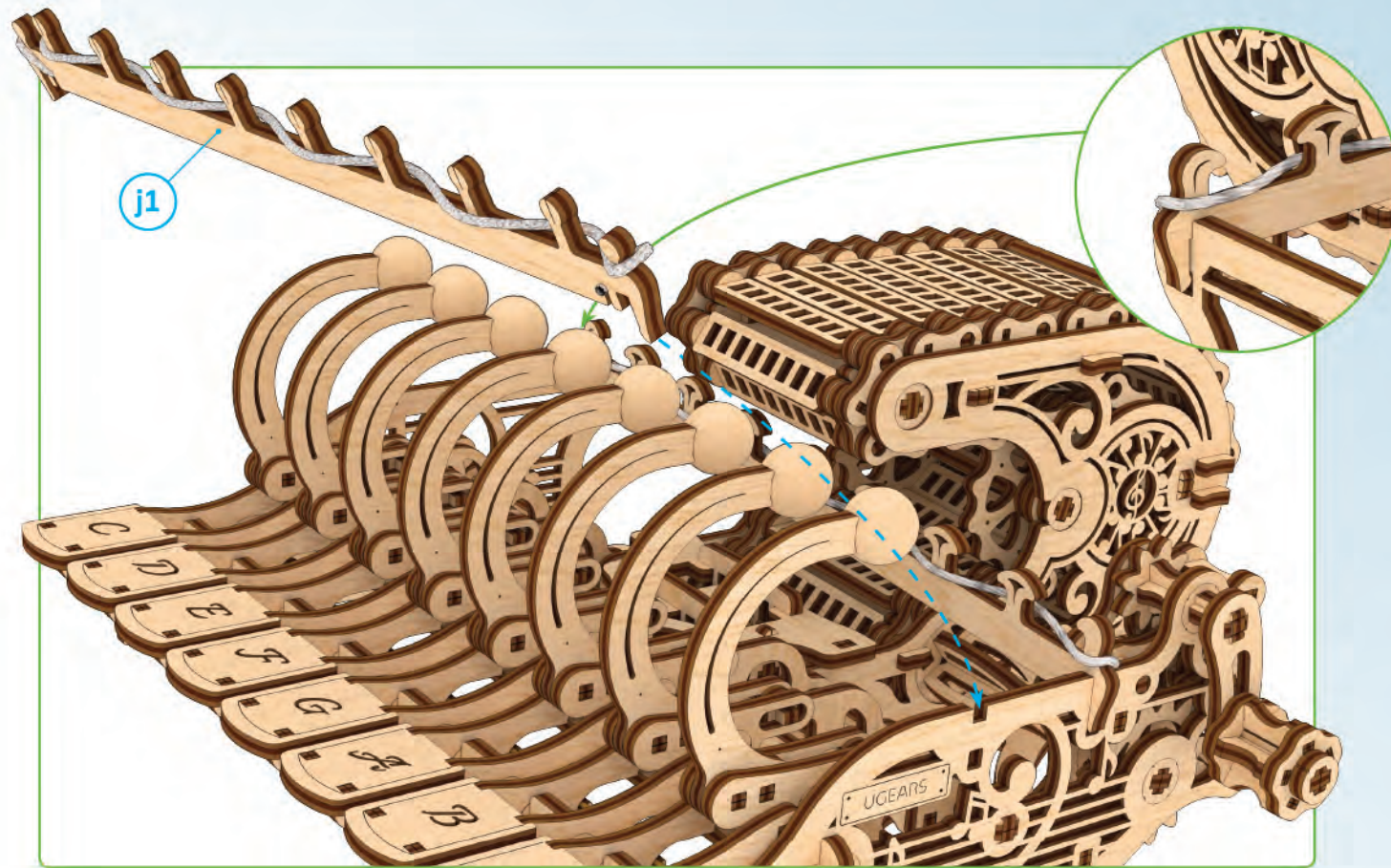

3

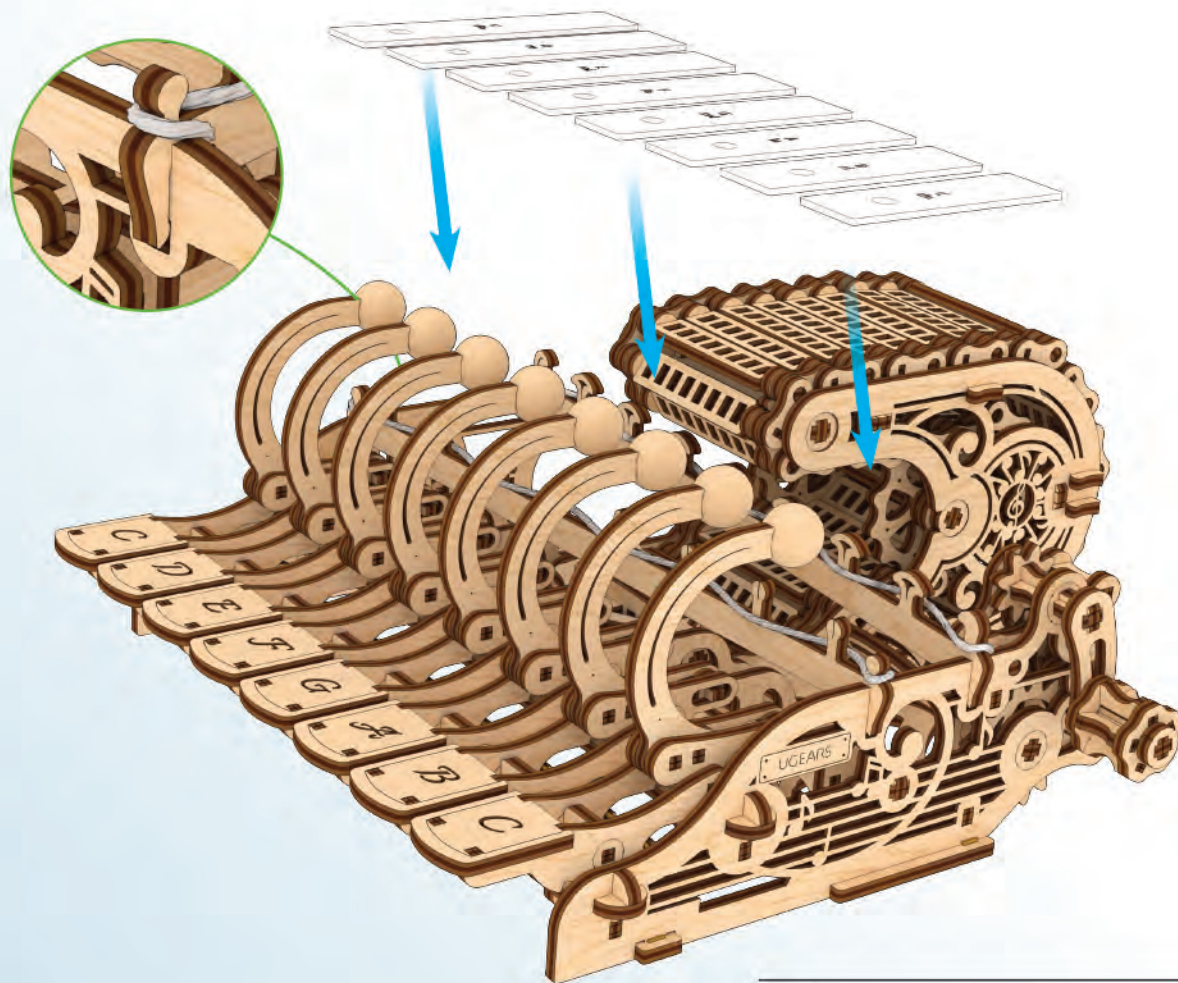

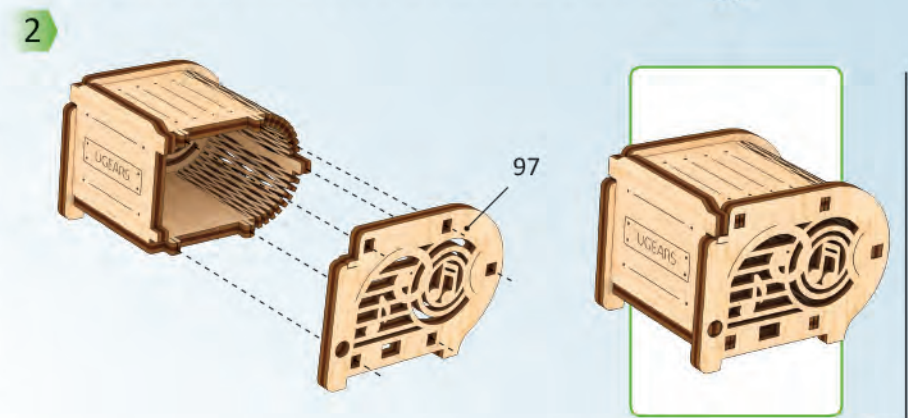
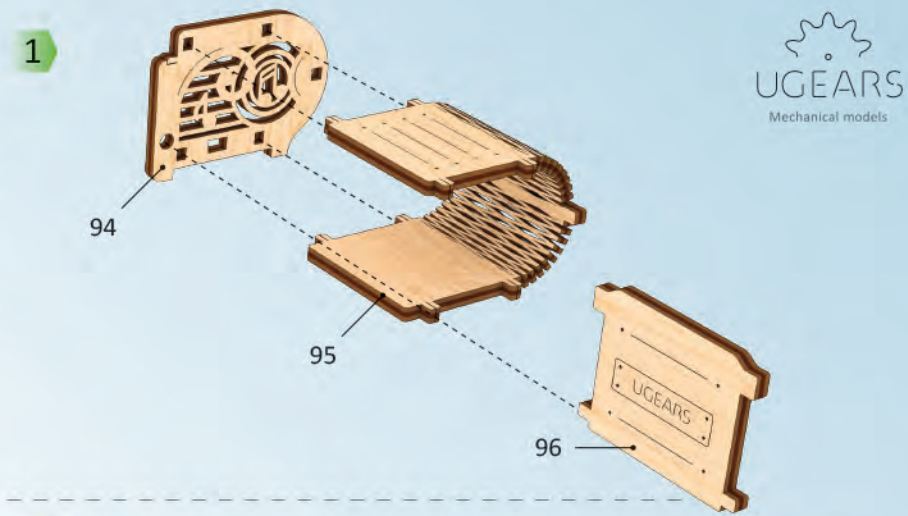
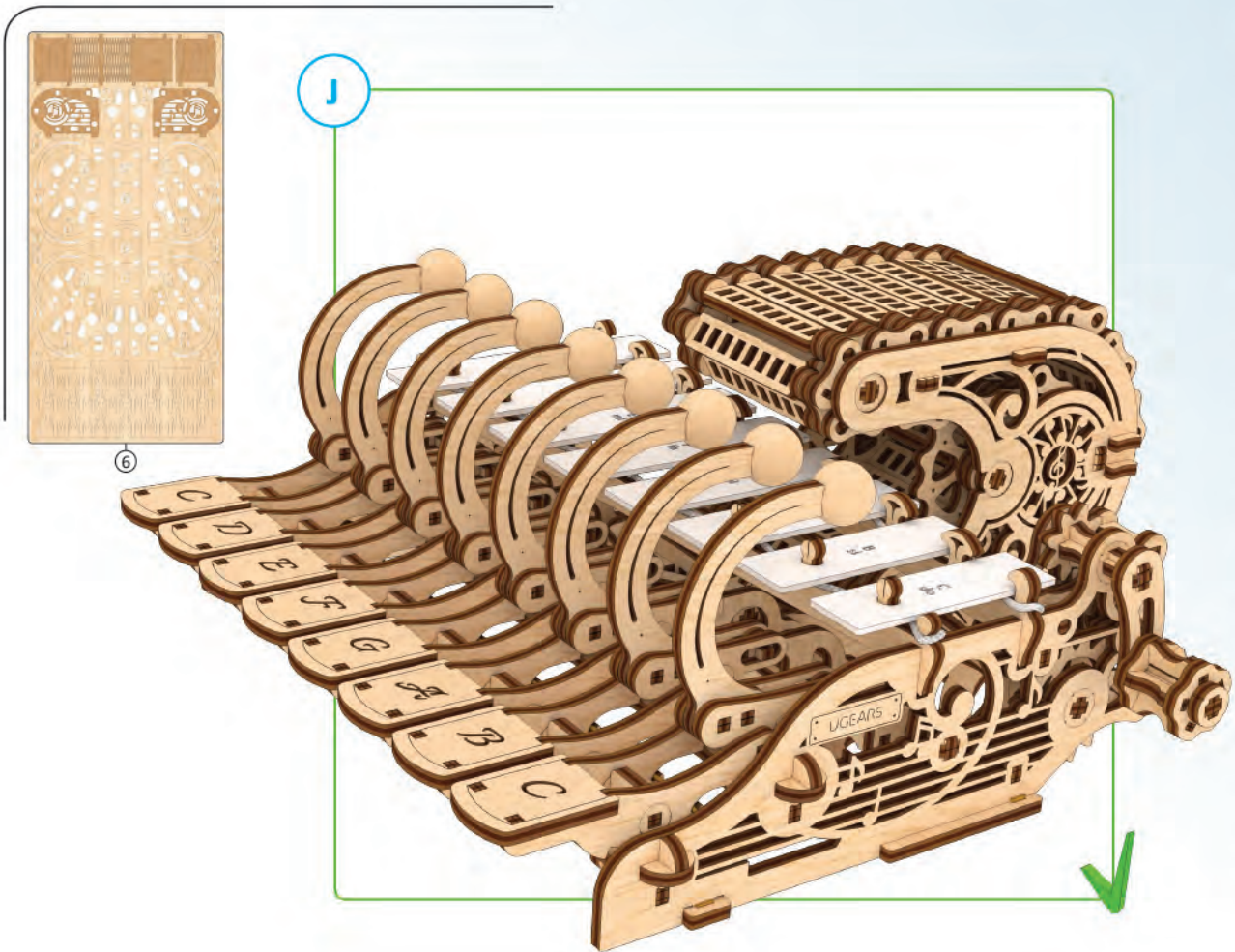

3

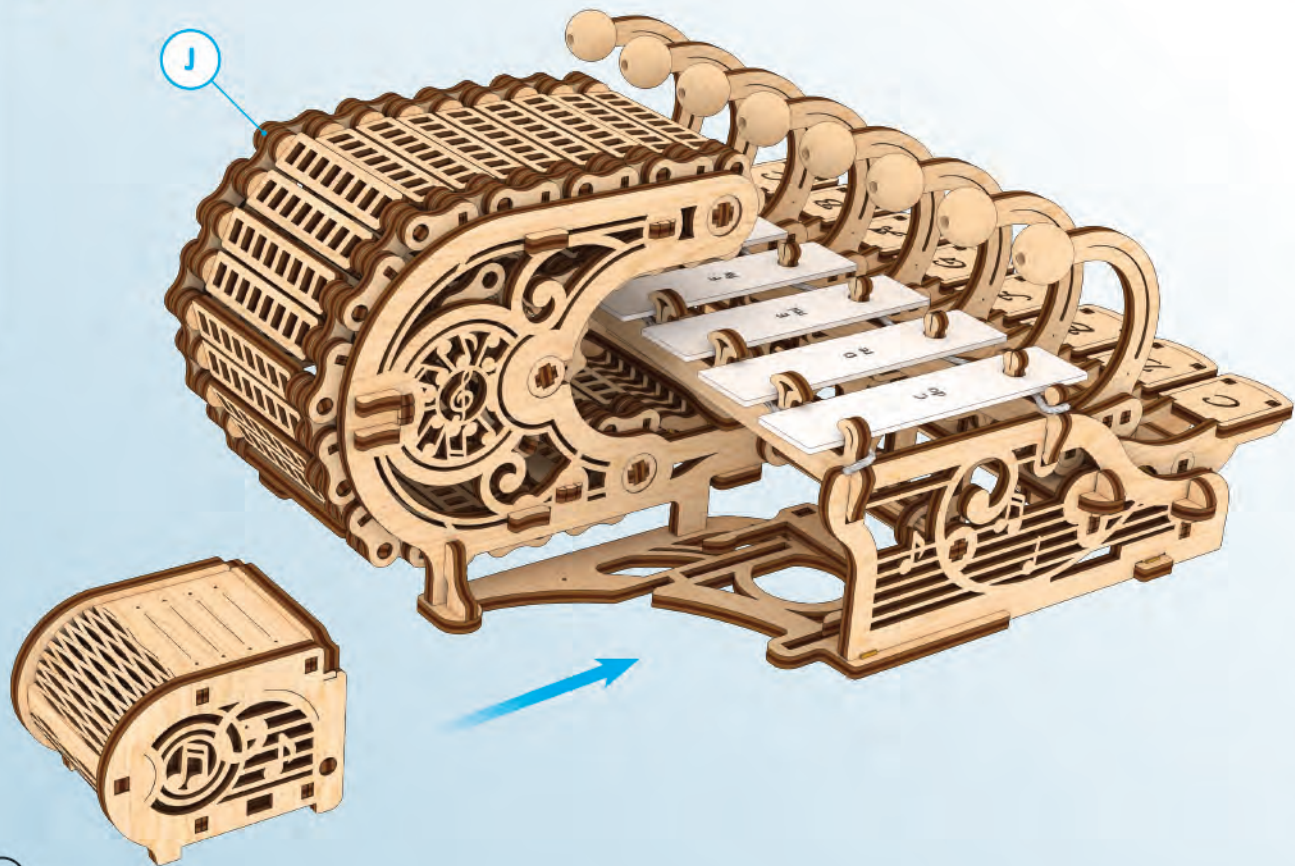

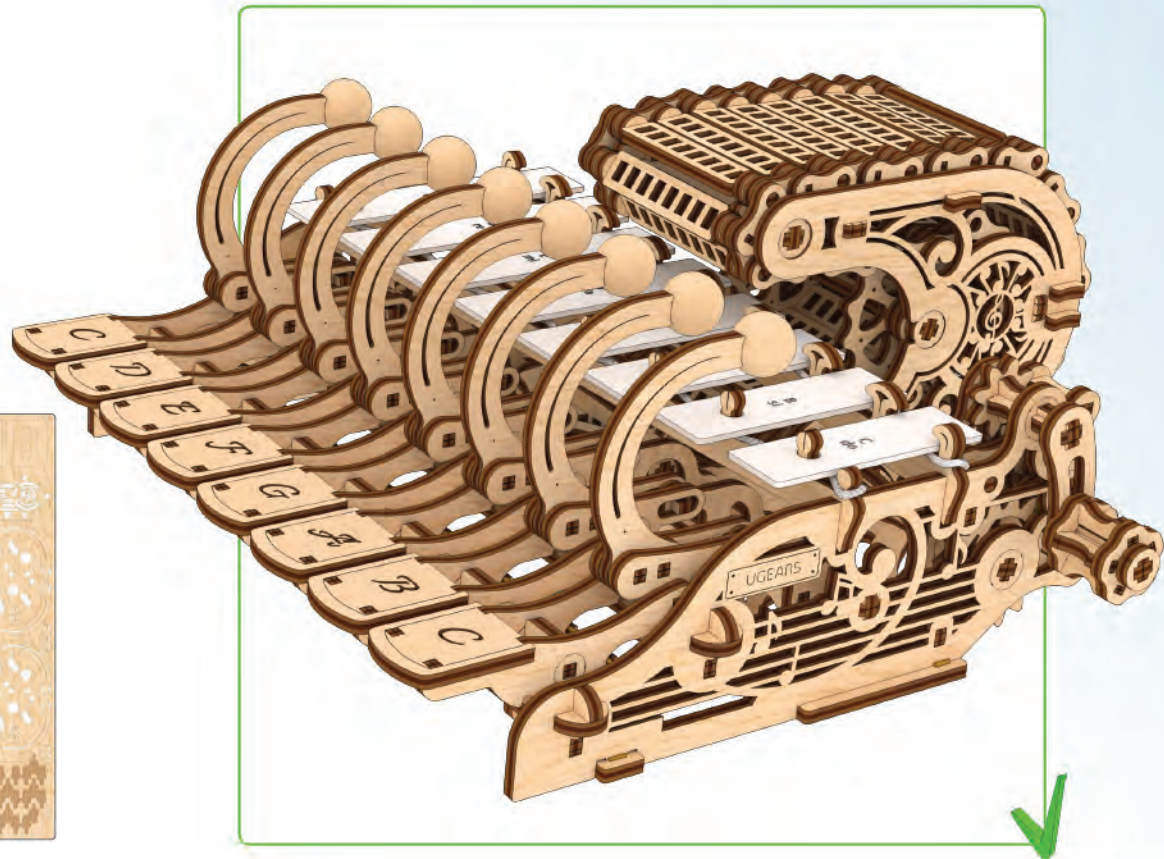

6

1



98

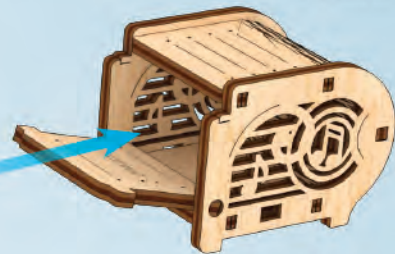

2

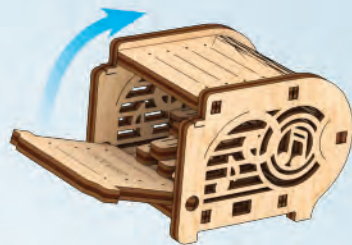

3

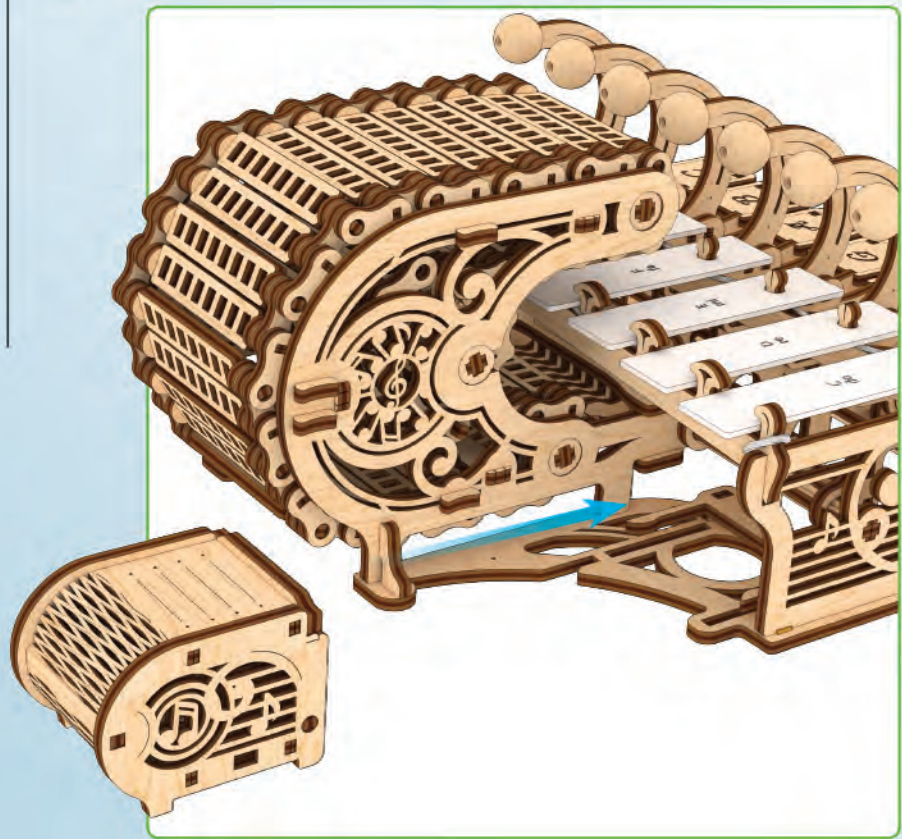

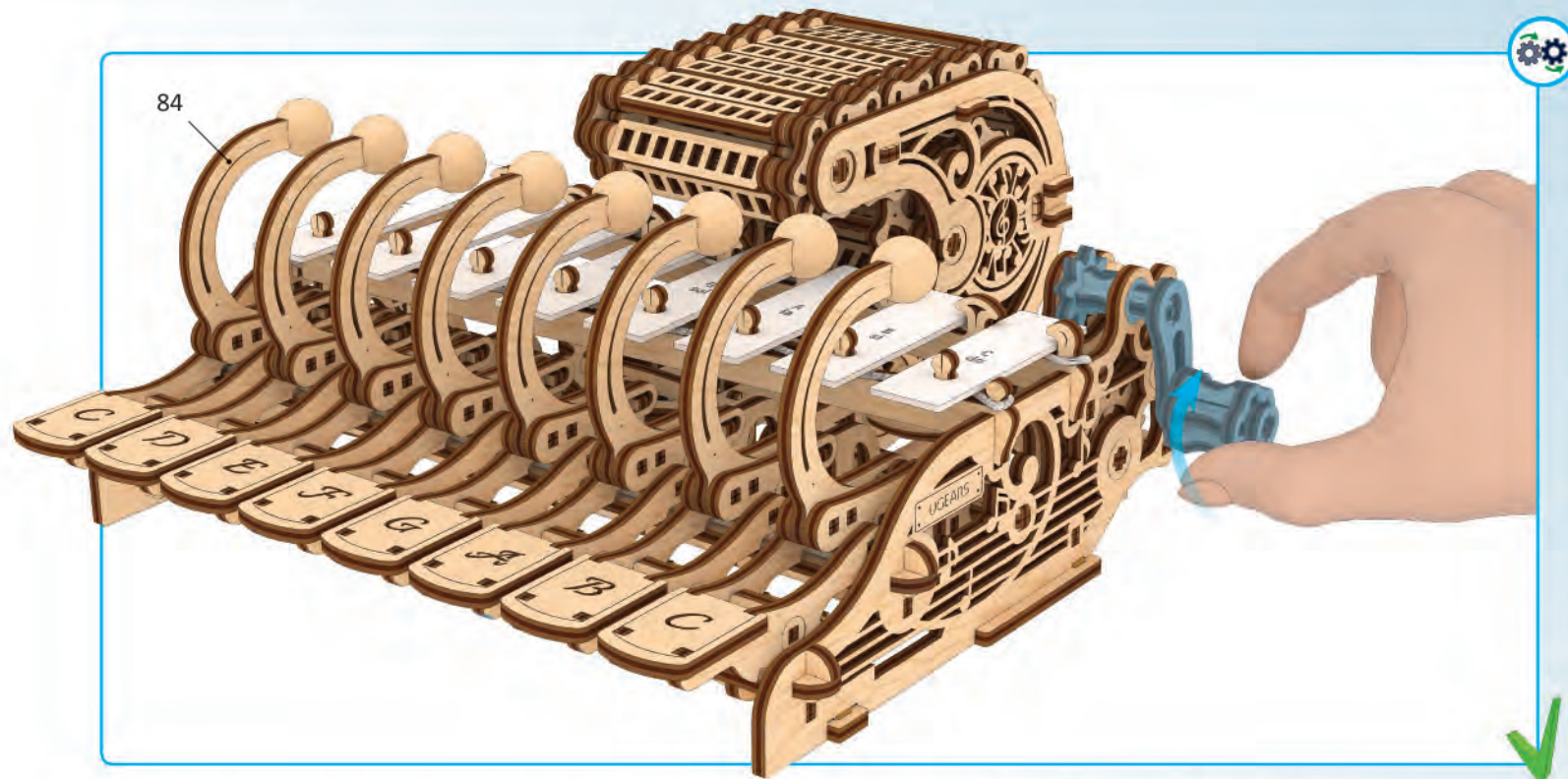

ENG If the marble on the trigger does not reach the plate you need to adjust the marble on the stud of part no. 84. **UKR** Якщо кулька на тригері не дістає до пластини, потрібно відрегулювати кульку на шпильці деталі №. 84. **FRA** Si la bille située sur la gâchette n'atteint pas la plaque, vous devez l'ajuster la bille sur le plot de la partie No 84. **DEU** Wenn die Kugel an dem Bügel die Platte nicht berührt, muss sie am Bolzen des Teils Nr. 84 eingestellt werden. **SPA** Si la bola en el elemento accionador no alcanza la placa, es necesario ajustar la bola en el perno de la pieza nº 84. **ITA** Se la biglia sul grilletto non raggiunge la piastra, è necessario regolare la biglia sul perno della parte numerata 84. **JPN** トリガーボールがプレートに届かない場合は、部品番号 84 ピンのボールを調整する必要があります。 **CHI** 如果扳機上的彈珠沒有到達板上，則需要調整零件編號螺柱上的彈珠。 84。 **POR** Se a bola que está no gatilho não atingir a chapa, é necessário ajustar a bola no pino da peça Nº 84. **POL** Jeśli kulka na wyzwalaczu nie dociera do płytki, trzeba wyregulować kulkę na trzpieniu części nr 84 **KOR** 트리거 구슬이 플레이트에 닿지 않는 경우에는, 부품 번호가 적힌 스타드의 구슬을 조정해야 합니다.

Carol of the bell

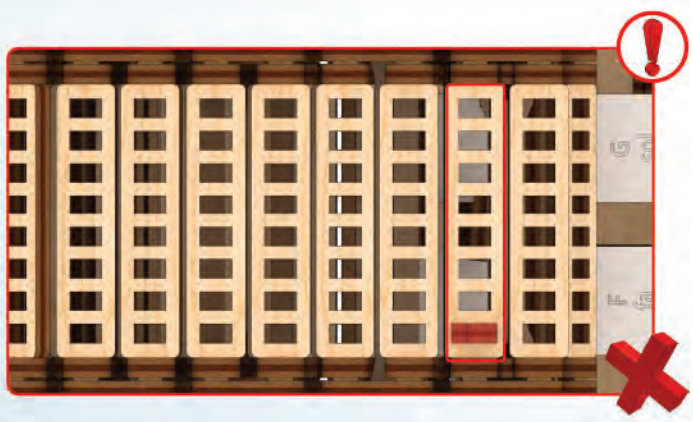
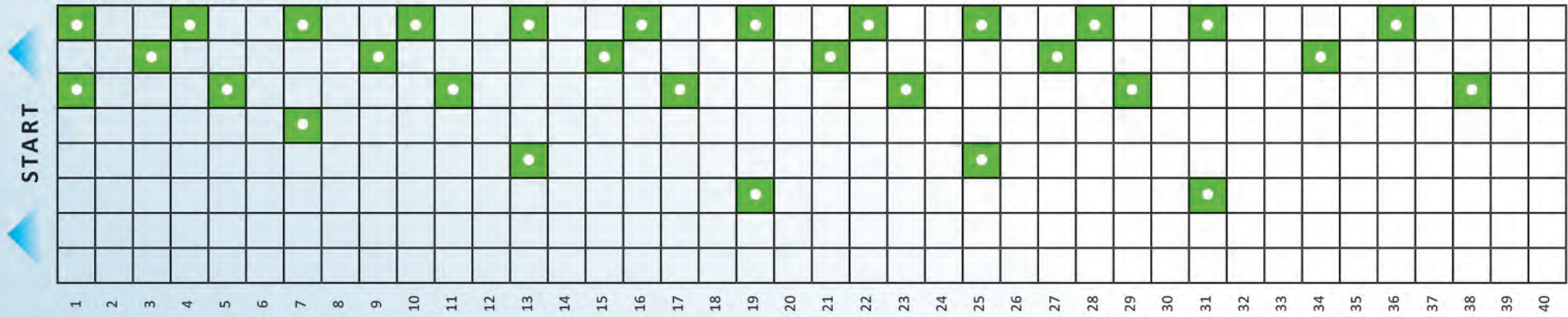

1



2

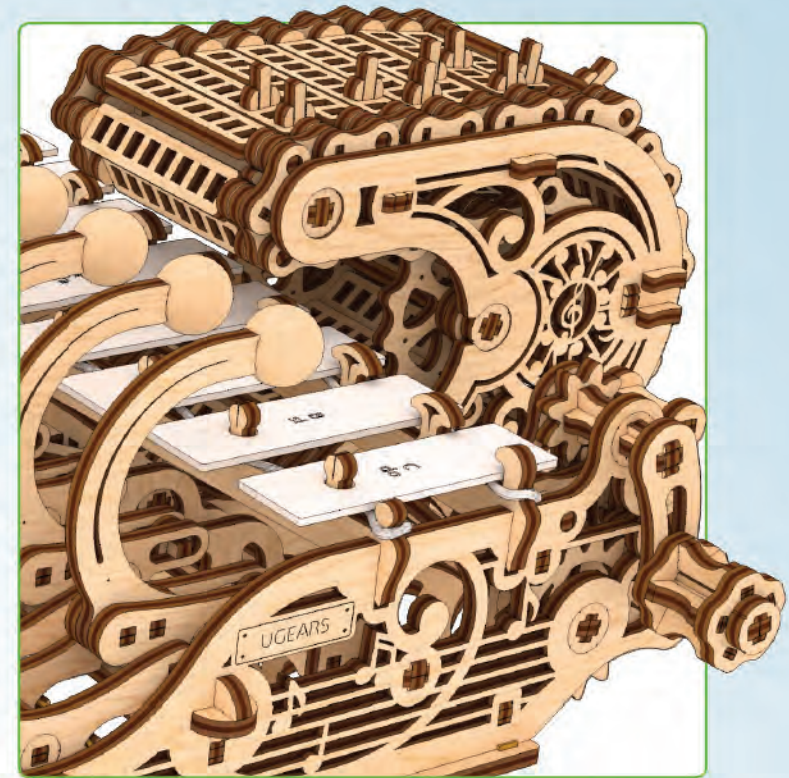
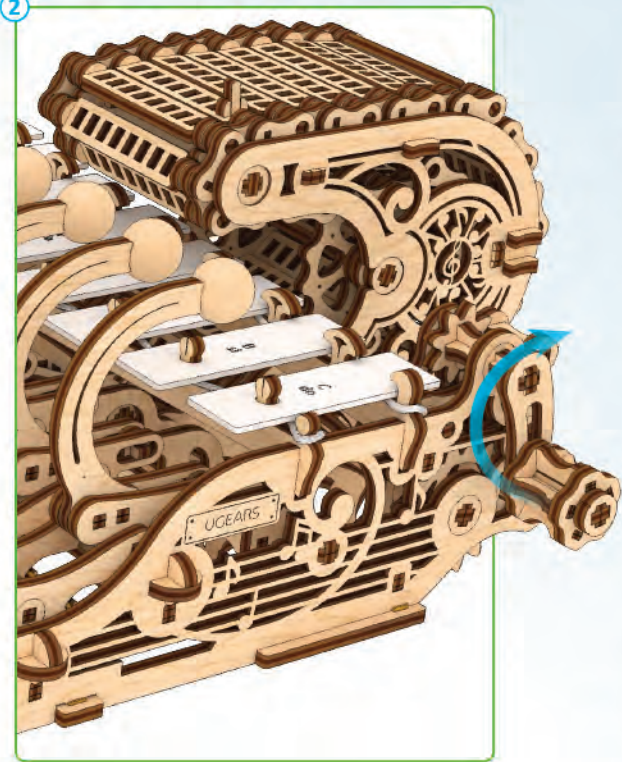

Happy Birthday

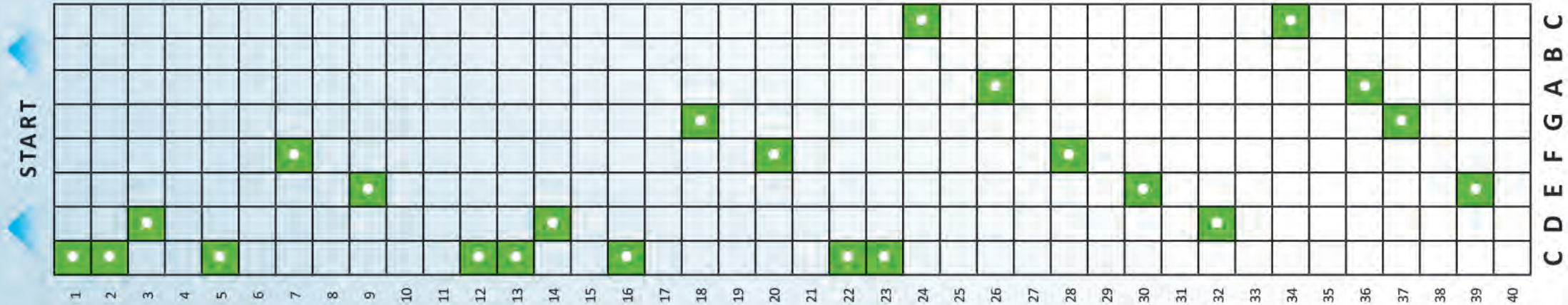

Ode To Joy

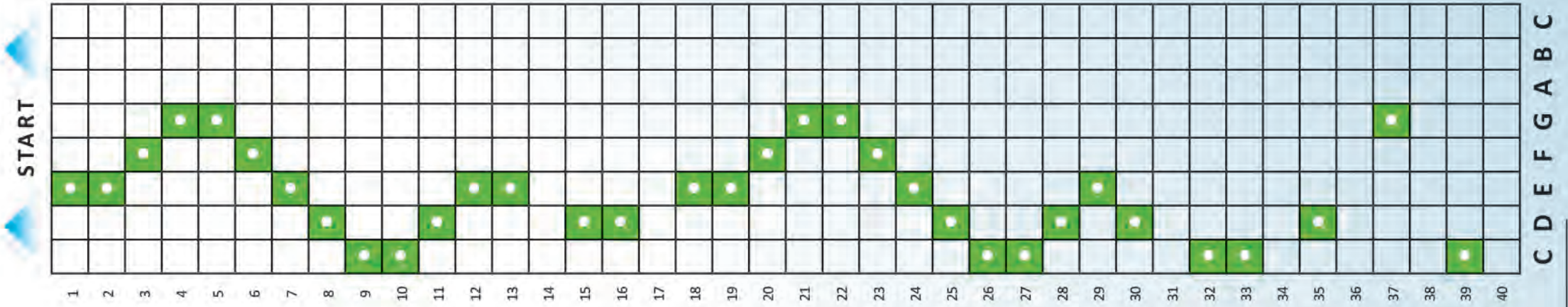

More melodies



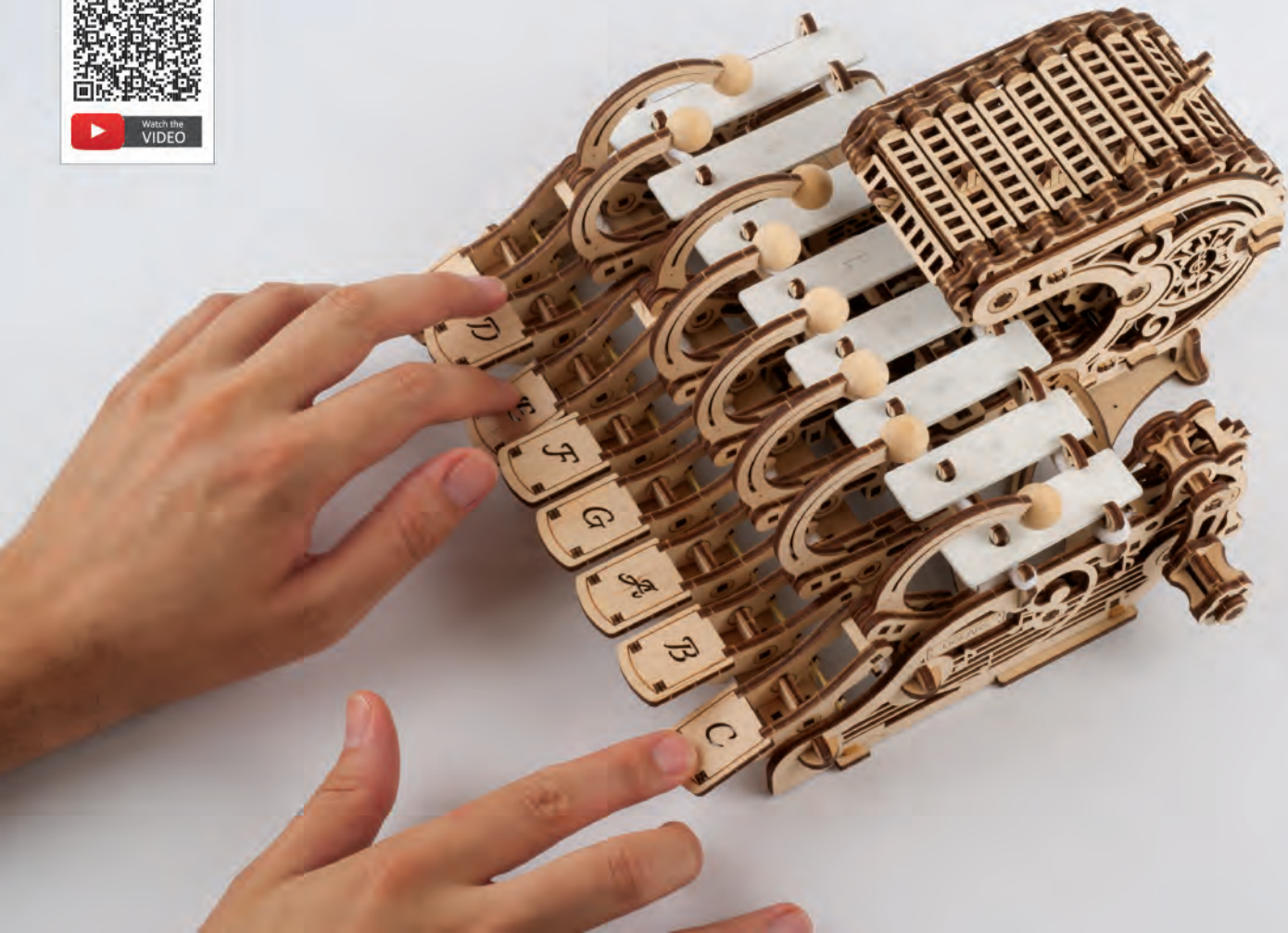

ENG Thanks for following along on this journey with us.

UKR Дякуємо, що ви пройшли цей шлях з нами.

FRA Merci denous avoir accompagnés tout au long de ces étapes.

DEU Vielen Dank, dass Sie diesen Weg mit uns gegangen sind.

SPA Gracias por haber recorrido el camino con nosotros.

ITA Grazie per aver fatto uesto percorso con noi.

JPN UGEARSをご利用いただきありがとうございます

CHI 感谢您参与有趣的模型拼装过程。

POR Obrigado por seguir nesta jornada conosco..

POL Dziękujemy, że razem z nami pokonałeś tę drogę!

KOR UGEARS 와 함께해 주셔서 감사합니다.

ugearsmodels.com

ENG Customer support **UKR** Служба підтримки

FRA Service client **DEU** Kundendienst

SPA Servicio al cliente **ITA** Servizio di supporto

JPN お客様窓口 **CHI** 客户支持

POR Atendimento ao cliente

POL Wsparcie klienta **KOR** 고객지원

customerservice@ugearsmodels.com