

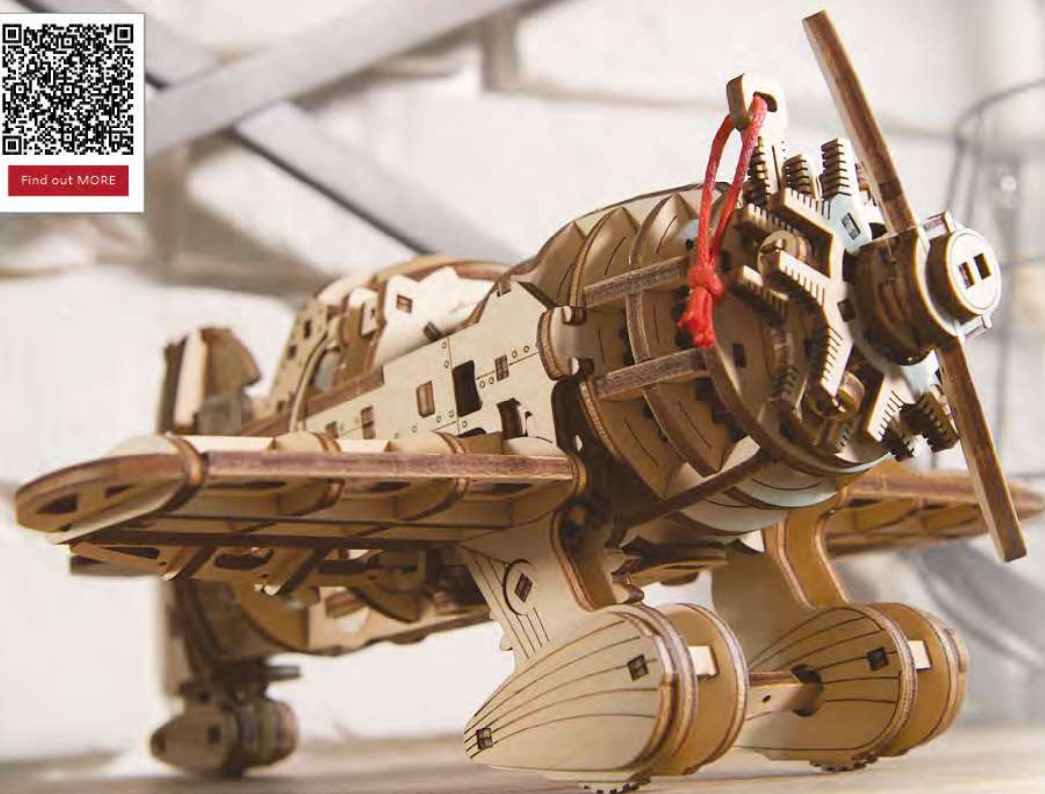

Find out MORE



Assemble me.

Perform preflight checks then taxi to the runway!

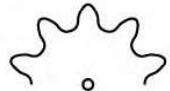
  
UGEAR'S®  
Mechanical models

## Mad Hornet Airplane Літак Скажений Шершень

FRA Avion Frelon Fou DEU Flugzeug Verrückte Hornisse

SPA Avión Avispón Loco

ITA Aeroplano Mad Hornet

JPN マッドホーネットエアプレーン

CHI 疯狂大黄蜂飞机 POR Avião Mad Hornet

POL Samolot Mad Hornet KOR 매드 호넷 비행기

### Assembly instructions Інструкція зі складання

FRA Notice d'assemblage. DEU Aufbauanleitung.

SPA Instrucciones de montaje. ITA Istruzioni di montaggio.

JPN 組み立て説明書 CHI 装配说明书 POR Instruções de montagem

POL Instrukcja montażu. KOR 조립 설명서.



MECHANICAL  
МЕХАНІЧНІ



NO GLUE CONNECTION  
БЕЗ КЛЕЮ



PLYWOOD  
З ФАНЕРИ

## Mechanical models

### ENG

**Assembly instructions:**  
Remove model parts from the hanger board as illustrated below. Careful not to break parts. If a part does not remove easily, carefully cut it out with a knife. This model is intended for self-assembly without glue. If you have difficulty installing the axles, try waxing them with a regular candle. All moving parts can also be waxed during assembly to reduce friction when operating the model.

### UKR

**Інструкція зі складання:**  
Витягніть з дошки позначені на схемі деталі. Намагайтеся їх не зламати. Якщо деталь не виймається, надсічіть перемички ножом. Конструкція збирається без клею. У разі виникнення труднощів з протягуванням вісі в отвір, потріть деталь об звичайну свічку. Також можна змастити свічкою всі деталі механізму, що рухаються, щоб зменшити тертя при обертанні.

### FRA

**Notice d'assemblage:**  
Faites sortir de la planche les pièces comme indiquées sur le schéma. Tâchez de ne pas les casser. Si la pièce ne sort pas, incisez les collages/fixations avec un couteau. La construction est à assembler sans colle. Si il est difficile d'introduire l'axe en bois dans l'orifice, frottez au préalable l'axe ou les pièces contre une bougie. Pour améliorer le glissement, traitez les pièces de frottement mobiles du mécanisme avec une bougie au cours d'assemblage.

### DEU

**Aufbauanleitung:**  
Bitte die in der Zeichnung angegebenen Teile aus der Platte herausnehmen. Versuchen Sie bitte diese nicht zu brechen. Wenn sich ein Teil nicht herausnehmen lässt, schneiden Sie die Stege mit dem Messer leicht an. Das Modell wird ohne Klebstoffe zusammengebaut. Lässt sich eine Achse nur schwer in eine Öffnung einführen, reiben Sie diese mit einer Kerze etwas ein. Für besseres Gleiten schmieren Sie alle beweglichen Teile mit einer Kerze.

### SPA

**Instrucciones de montaje:**  
Saque de la tabla las piezas marcadas en el esquema. Trate de no romperlas. Si una pieza no se saca, haga una incisión. La construcción va sin pegamento. Si tiene dificultades con la instalación del eje de madera en un agujero, frote primero el eje o las piezas contra una vela. Para un mejor deslizamiento, lubrique durante el montaje las piezas móviles del mecanismo con una vela común.

### ITA

**Istruzioni di montaggio:**  
Estrarre dal telaio i particolari indicati nello schema. Fare attenzione a non romperli. Se un particolare non si stacca, tagliare delicatamente gli elementi di collegamento con un coltello. L'assieme viene realizzato senza colla. In caso di difficoltà nell'insierimento di un perno in legno, è necessario sfregare il perno o il particolare con un po' di cera. Per uno scorrimento migliore incerare le parti mobili del meccanismo durante l'assemblaggio.

### JPN

**組み立て説明書:**  
部品に傷をつけないように注意しながらボードから外してください。部品が外れにくい場合は連結部分をカッターで切ってから外すと外しやすいです。本製品は、接着剤がなくても組み立てができるように設計されています。もしアクスル(駆動部)が、歯車の動きがにぶい場合は、口ウソクをアクスルに塗ってください。全ての駆動部分は製品を動かす時、滑らかに動くように潤滑剤である口ウソクを塗りながら組み立てます。

### CHI

**装配说明**  
将模型部件按插图所示，从胶合板取下。小心不要损坏零件。如果取下时候有难度，请用小刀小心的切割连接点。这个产品不需要胶水粘接。如果安装转轴的时候有难度，请用普通的蜡加以润滑。所有的转动部分也需要打蜡润滑。

### POR

**Instruções de montagem:**  
Remova as peças do modelo da placa de suporte conforme ilustrado abaixo com cuidado para não quebrá-las. Se uma peça não puder ser removida facilmente, corte a cuidadosamente com uma faca. Este modelo foi feito para ser montado de forma prática, sem precisar usar cola. Se você tiver dificuldade em instalar os eixos, tente passar um pouco de cera, como por exemplo, a de uma vela comum. Todas as peças móveis também podem ser enceradas durante a montagem para reduzir o atrito ao operar o modelo.

### POL

**Instrukcja montażu:**  
Delikatnie wyciągaj z deseczki wskazane w schemacie detale, starając się nie polamać elementów. Jeśli detal nie poddaje się, podetnij wiązadła nożem. Konstrukcje składa się bez kleju. Jeśli napotkasz trudności z instalacją drewnianej osi w otwór, potrzyj na początku oś lub detale o woskową świecę. Dla lepszego poślizgu polecano smarowanie ruchomych części mechanizmu zwykłą świecą podczas montażu.

### KOR

**조립 설명:**  
부품이 손상되지 않도록 주의하여 보드에서 떼어냅니다. 만약 부품이 잘 떨어지지 않으면 연결 부분을 칼로 절단 한 후 떼어내면 쉽게 떼어 낼 수 있습니다. 본 제품은 접착제가 없이 조립이 가능하도록 설계되어 있습니다. 만약 축이 잘 끼워지지 않는 경우 양초를 축에 바른 후 끼워 보세요. 모든 구동 부위는 제품 구동 시 원활한 작동이 가능하도록 조립 과정에서 윤활제(양초)양초를 발라 주세요.

**ENG Warning! UKR Увага! FRA Attention! DEU Achtung! SPA Precaución! ITA Attenzione! JPN 注意! CHI 注意! POR Atenção! POL Uwaga! KOR 주의!**



**ENG Do not use a lighted candle! UKR Не підпалювати! FRA Ne pas brûler! DEU Nicht anzünden! SPA ¡No encender! ITA Non dare fuoco! JPN 火のついた口ウソクの使用はお止めください。 CHI 请勿点燃，请勿靠近火源! POR Não use uma vela acesa! POL Nie podpalać! KOR 불이 붙은 조를 이용하지 마세요!**

ENG Customer support UKR Служба підтримки FRA Service client DEU Kundendienst SPA Servicio al cliente

ITA Servizio di supporto JPN お客様窓口 CHI 客戶支持 POR Atendimento ao cliente POL Wsparcie klienta KOR 고객센터

customerservice@ugearsmodels.com



ENG Pay attention. Check position of the part. UKR Зверніть увагу. Перевірте розташування елемента. FRA Faites attention. Vérifiez la disposition de l'élément. DEU Bitte Beachten. Prüfen Sie die Einbaulage des Elementes. SPA Atención. Compruebe la situación del elemento. ITA Prestare attenzione. Controllare la posizione del componente. JPN 方向及び位置に注意して組み立ててください。CHI 注意! 检查部件方向和位置。POR Preste atención. POL Zwróć uwagę. Sprawdź lokalizację elementu. KOR 방향 또는 위치에 주의해서 조립해 주세요.



ENG Sand to remove burrs. UKR Видаліть задирки. FRA Éliminez les bavures. DEU Grate entfernen. SPA Quite las rebabas. ITA Togliere le bave. JPN バリ取りのサンドペーパー。CHI 磨掉毛刺。POR Lixe para remover as rebabas. POL Usuj zadziory. KOR 거친 부분을 다듬어 주세요.



ENG Wax the part with a regular candle (rub with a candle). UKR Змастіть деталь звичайною свічкою (потріть об свічку). FRA Lubrifiez la pièce avec une bougie ordinaire (frottez contre la bougie). DEU Reiben Sie das Teil mit einer einfachen Kerze etwas ein. SPA Engrasa la pieza con una vela común (frote con una vela). ITA Incerare il componente (sfregare con la cera). JPN された部分に潤滑剤として口ウソクを塗ってください。CHI 用普通蠟燭塗抹潤滑部件。POR Encere a peça com uma vela comum (esfregue com uma vela). POL Przesmaruj zwykłą świecą. KOR 표시된 부분에 윤활을 위해 촛를 칠해 주세요.



ENG Check the mechanism for smoothness and accuracy of movement. Operate the mechanism so the parts would seat-in. UKR Перевірте механізм на плавність і точність ходу. Розробіть механізм. FRA Vérifiez si le mécanisme fonctionne en douceur et avec précision. Faites fonctionner le mécanisme jusqu'à son fonctionnement normal. DEU Prüfen Sie den Mechanismus bezüglich der Laufruhe und der Genauigkeit des Ganges. Betätigen Sie den Mechanismus mehrmals. SPA Verifique la suavidad y precisión del mecanismo. Desarrolle el mecanismo. ITA Controllare la scorrevolezza e la precisione del movimento. Far funzionare il meccanismo. JPN 駆動部分が滑らかに動くかを確認しながら作業をすめます。CHI 检查机构的运行平稳度和精确度。调整机构。POR Teste a suavidade e precisão do movimento do mecanismo. Opere o mecanismo para que as peças se encaixem. POL Sprawdź płynność i dokładność ruchu mechanizmu. Dopracuj mechanizm. KOR 구동 부분의 원활한 작동과 정확한 움직임을 확인하세요.



ENG Check size. UKR Перевірте розмір. FRA Vérifiez la dimension. DEU Prüfen Sie die Größe. SPA Compruebe el tamaño. ITA Controllare le dimensioni. JPN サイズをチェックしてください。CHI 測量尺寸。POR Verifique o tamanho. POL Sprawdź rozmiar. KOR 크기를 확인해 주세요.



ENG Cut (rubber-band, thread, etc.). UKR Відріжте (гумку, нитку, тощо). FRA Couper (ruban élastique, fil, etc.). DEU Schneiden (Gummiband, Faden, etc.). SPA Cortar (goma elástica, hilo, etc.). ITA Tagliare (fascia in gomma, filettatura, ecc.). JPN カットしてください。(輪ゴム、糸など)。CHI 切割(橡皮筋, 线等)。POR Corte (elástico, fio, etc.). POL Utnij (gumkę, nitkę, itd.). KOR 잘라(고무밴드, 이부사기 등)



ENG The part should be easily rotated (moved). UKR Деталь повинна легко крутитися (рухатися). FRA La pièce doit tourner (se déplacer) aisément. DEU Der Teil soll leicht gedreht (bewegt) werden. SPA La pieza debe ser fácil de girar (mover). ITA Il componente deve girare (muoversi) facilmente. JPN 部品はしつかりと動かなければなりません。CHI 此部件必须容易的旋转(移动)。POL Element powinien łatwo się kręcić (poruszać się). POR A peça deve ser facilmente girada (movida). KOR 잘라 쉽게 움직일 수 있어야 합니다.



ENG Do not fully press the outer parts (structural frame) together until checking for fit and alignment of internal parts. UKR Деякий час не притискайте сильно деталі (рамки конструкції). FRA Ne pas forcer sur les pièces (cadre de la construction). DEU Drücken Sie die Teile (die Rahmen der Konstruktion) momentan nicht stark. SPA No presione temporalmente con fuerza las piezas (marco de la estructura). ITA Non stringere provvisoriamente i componenti con forza (basta della costruzione). JPN 内部部品がしっかりと組み立てられる前に外部部品は強く押しながら固定してはいけません。CHI 在检查内部零件的配合和对准之前, 请暂时不要将外部零件(结构框架)完全压在一起。POR Não pressione totalmente as peças externas (estruturais) até verificar que as peças externas estão bem encaixadas e alinhadas. POL Tymczasowo nie dociskaj elementów (ramy konstrukcji). KOR 아직은 외부의 틀을 완전히 눌러서 고정하면 안 됩니다. 다른 부품을 먼저 끼우세요.



ENG Press the parts as far as they will go. UKR Притисніть деталі до упору. FRA Pressez les pièces à fond. DEU Drücken Sie die Teile bis zum Anschlag. SPA Pulse para detener las piezas. ITA Stingere bene i componenti. JPN 部品をできるだけ押しつけてください。CHI 用力緊密結合部件。POR Pressione as peças o máximo possível. POL Przyścisnij element, aż do oporu. KOR 부품을 양쪽에서 눌러서 고정해 주세요.



ENG Specified details come with spare duplicates. UKR Зазначені деталі є на дошках як запасні. FRA Les détails spécifiés sont fournis avec des doublons de rechange. DEU Die angegebenen Details werden mit Ersatzduplikaten geliefert. SPA Los detalles especificados vienen con duplicados de repuesto. ITA I dettagli specificati vengono forniti con duplicati di riserva. JPN 指定された詳細には予備の複製が付属しています。CHI 指定的細節帶有備用副本。POR Os detalhes especificados vêm com peças sobressalentes duplicadas. POL Zapasowe elementy są zaznaczone na desce. KOR 명시된 세부 사항은 여분의 복사본과 함께 제공됩니다.



ENG This is not a structural component; it is a tool for measurement and assembly.

UKR Це не деталь конструкції, а допоміжний інструмент для складання або вимірювання відстаней. FRA Cette pièce n'est pas partie de la construction mais constitue un outil annexe pour l'assemblage ou la mesure des distances. DEU Es ist kein Teil der Konstruktion, sondern ein Hilfselement für den Zusammenbau oder für das Messen der Abstände. SPA No es una pieza de la construcción sino un instrumento auxiliar para montar o para medir distancias. ITA Non è un componente del modello, ma un'attrezzatura aggiuntiva per il montaggio o il rilievo delle quote. JPN この部品は完成時の部品ではなく、組み立てをサポートしたり測定する道具です。

CHI 这不是装配零部件, 是一种测量及安装辅助工具。POR Este não é um componente estrutural, é uma ferramenta para medição e montagem. POL To nie detal konstrukcji, a pomocnicze narzędzie dla montażu i wymiaru odległości. KOR 이 부품은 조립을 위한 부품이 아니고 조립을 돕거나 측정을 위한 도구입니다.

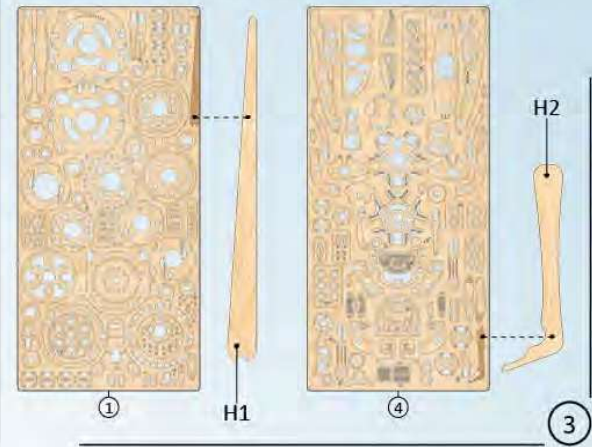
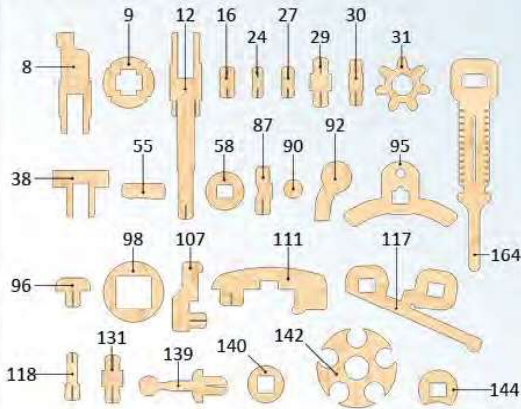

### Mechanical models



• **ENG** It's easier to pull out some parts with the «helper (H1)». **UKR** Буде легше видавити готові деталі за допомогою «helper (H1)». **FRA** Il est plus facile de retirer certaines pièces avec la pièce-outils (H1). **DEU** Es ist einfacher, einige Teile mit dem "Helfer (H)" herauszunehmen. Siehe Beispiel: **SPA** Para separar algunas partes resulta más fácil utilizando la ayuda del elemento "H1". **ITA** È più facile estrarre alcuni elementi utilizzando l' "aiuto (H1)". **JPN** ある部品は「helper (H1)」を使うと取り外しやすいです。 **CHI** 使用「helper (H1)」可以更轻松地拉出某些零件。 **POR** É mais fácil retirar algumas peças usando a «peça auxiliar(H1)». **POL** Niektóre części łatwiej jest wyciągnąć za pomocą "pomocnika (H1)". **KOR** 일부 부품은 'H1' 도구를 이용하여 떼어내면 쉽습니다.

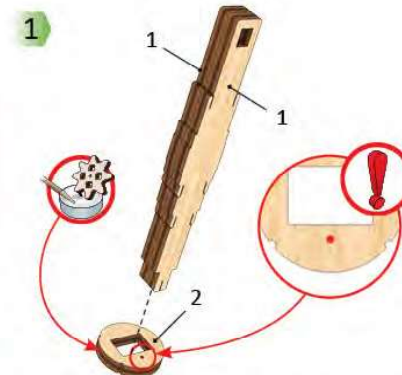
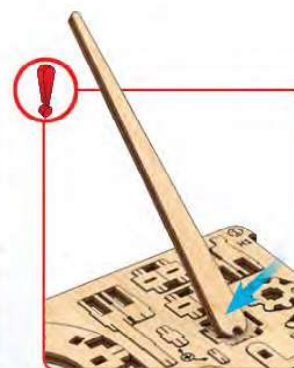
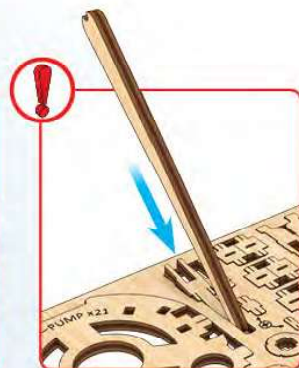
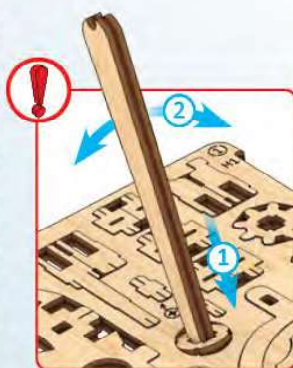

2 ①

3

4

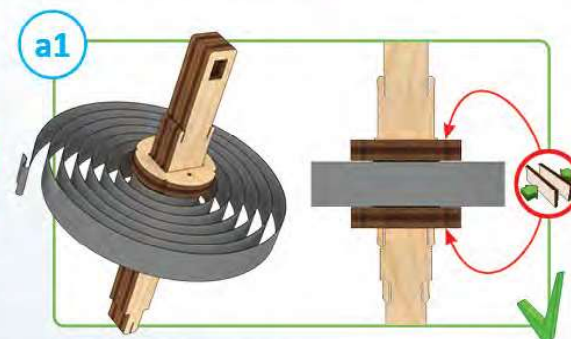
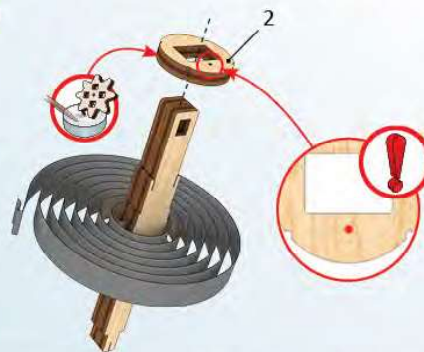
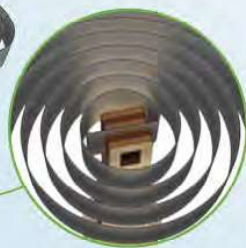

**ENG** Pay attention. Check position of the part. **UKR** Зверніть увагу. Перевірте розташування елемента. **FRA** Faites attention. Vérifiez la disposition de l'élément. **DEU** Bitte Beachten. Prüfen Sie die Einbaulage des Elementes. **SPA** Atención. Compruebe la situación del elemento. **ITA** Prestare attenzione. Controllare la posizione del componente. **JPN** 方向及び位置に注意して組み立ててください。 **CHI** 注意！检查零件方向和位置。 **POR** OPreste atenção. **POL** Zwróć uwagę. Sprawdź lokalizację elementu. **KOR** 방향 또는 위치에 주의해서 조립해 주세요.



**ENG** Wax the part with a regular candle (rub with a candle). **UKR** Змастіть деталь звичайною свічкою (потріть об свічку). **FRA** Lubrifiez la pièce avec une bougie ordinaire (frottez contre la bougie). **DEU** Reiben Sie das Teil mit einer einfachen Kerze etwas ein. **SPA** Engrase la pieza con una vela común (frote con una vela). **ITA** Incerare il componente (sfregare con la cera). **JPN** された部分に滑潤剤として口ソックを塗ってください。 **CHI** 用普通蠟燭塗抹潤滑部件。 **POR** Encere a peça com uma vela comum (esfregue com uma vela). **POL** Przesmaruj zwykłą świecą. **KOR** 표시된 부분에 윤활을 위해 초를 칠해 주세요.



**ENG** Press the parts as far as they will go. **UKR** Притисніть деталі до упору. **FRA** Pressez les pièces à fond. **DEU** Drücken Sie die Teile bis zum Anschlag. **SPA** Pulse para detener las piezas. **ITA** Stingere bene i componenti. **JPN** 部品をできる限り押し込んでください。 **CHI** 用力緊密結合部件。 **POR** Pressione as peças o máximo possível. **POL** Przyciśnij element, aż do oporu. **KOR** 부품을 양쪽에서 눌러서 고정해 주세요.

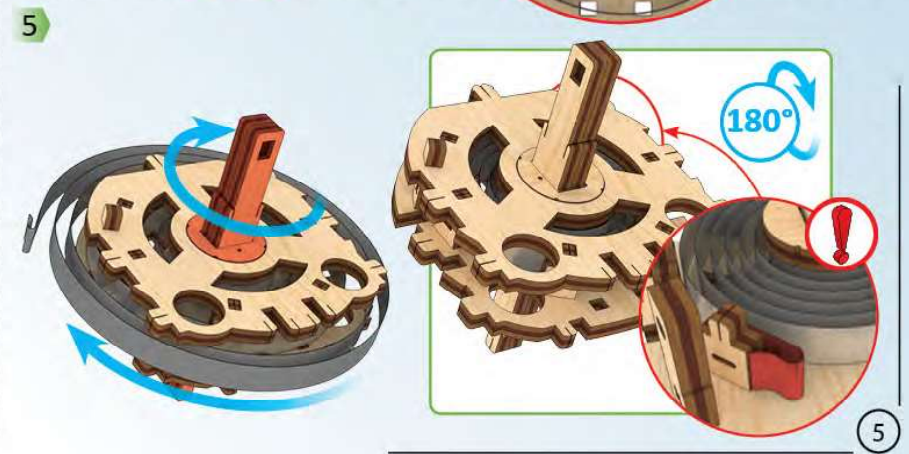
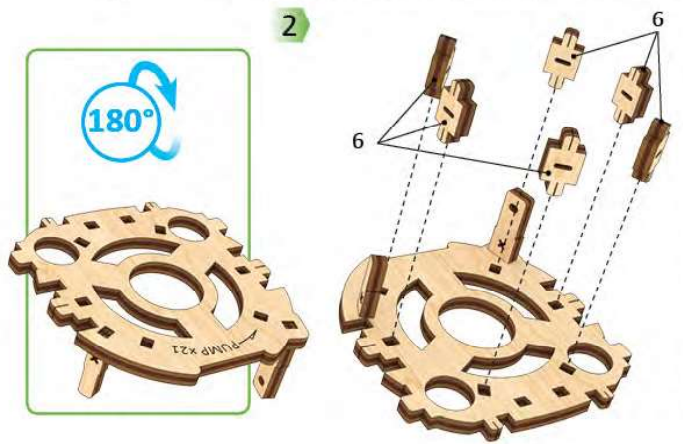
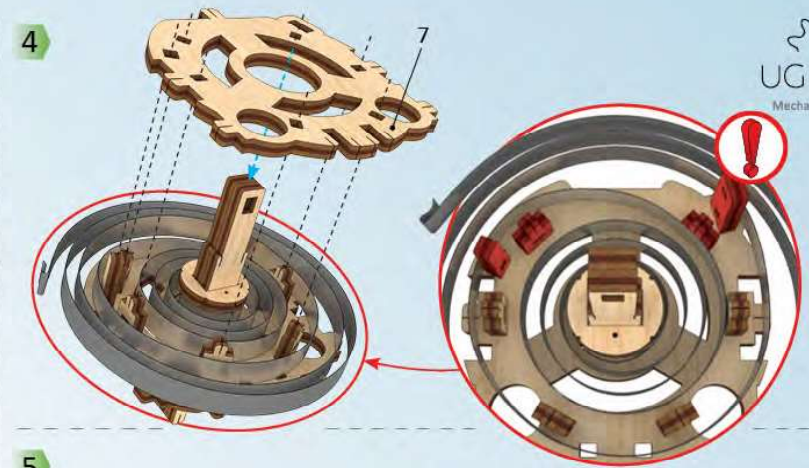
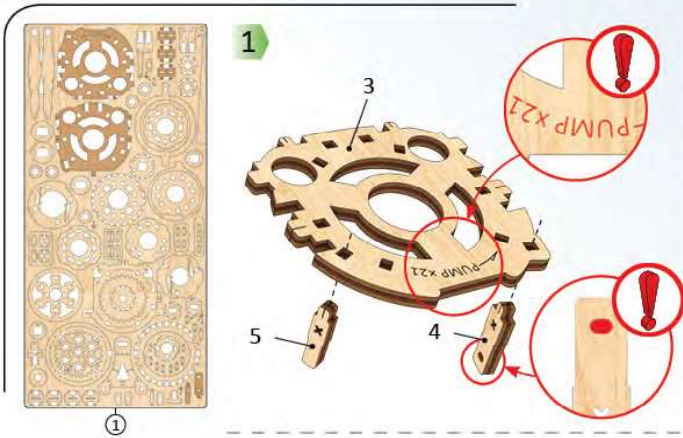

Mechanical models

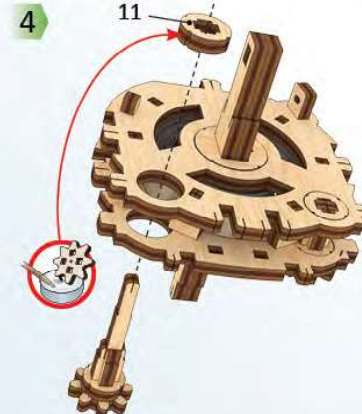
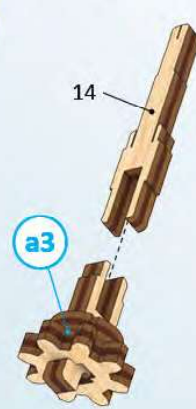
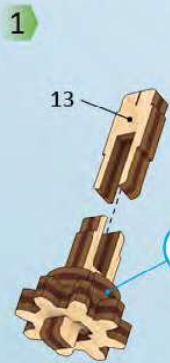
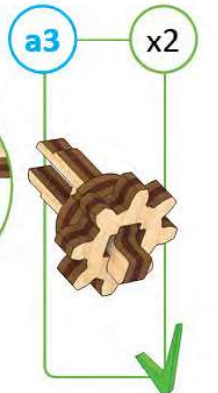
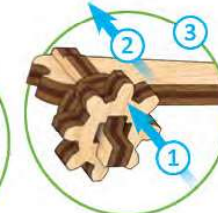
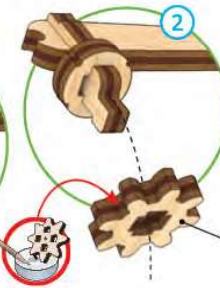
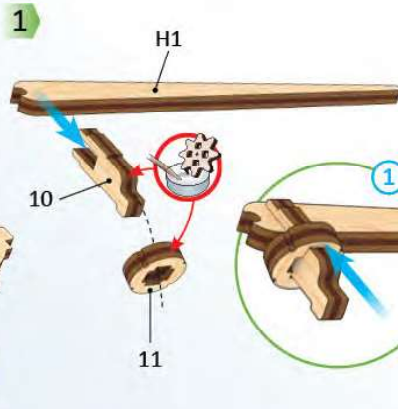
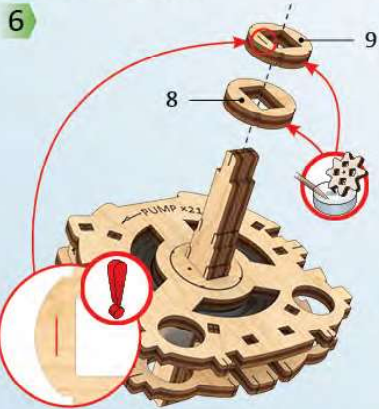
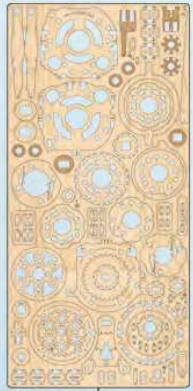

**1** 16 16 15 16 16

**2** 17

**a7**

**1** 19 18

**180°**

**2** 1

**a7**

**1** 22 20 20 20 21

**a8**

**a9**

①

ENG Sand to remove burrs. UKR Видаліть задирки. FRA Eliminez les bavures. DEU Grate entfernen. SPA Quite las rebabas. ITA Togliere le bave. JPN バリ取りのサンドペーパー CHI 磨掉毛刺 POR Lixe para remover as rebarbas. POL Usuń zadzior. KOR 거친 부분을 다듬어 주세요.

Mechanical models

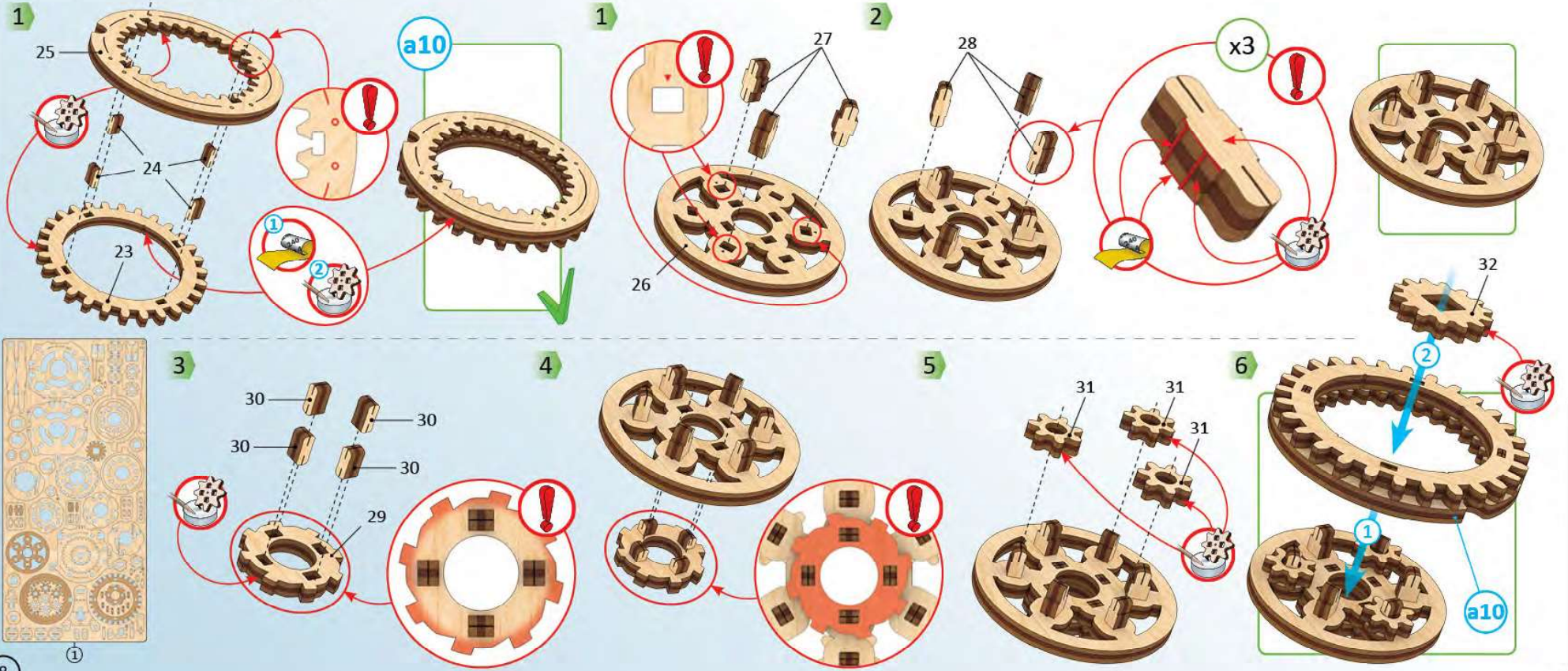



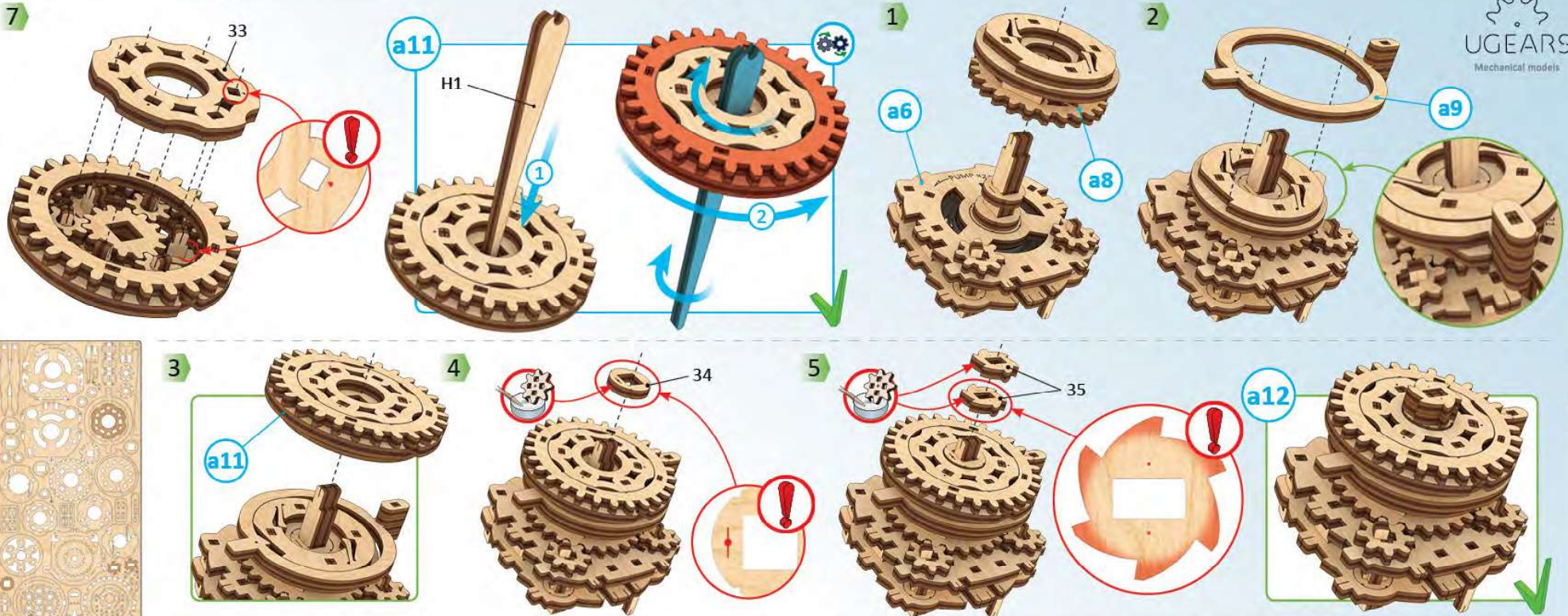

**ENG** Check the mechanism for smoothness and accuracy of movement. Operate the mechanism so the parts would seat-in. **UKR** Перевірте механізм на плавність і точність ходу. Розробіть механізм. **FRA** Vérifiez si le mécanisme fonctionne en douceur et avec précision. Faites fonctionner le mécanisme jusqu'à son fonctionnement normal. **DEU** Prüfen sie den Mechanismus bezüglich der Laufruhe und der Genauigkeit des Ganges. Betätigen Sie den Mechanismus mehrmals. **SPA** Verifique la suavidad y precisión del mecanismo. Desarrolle el mecanismo. **ITA** Controllare la scorrevolezza e la precisione del movimento. Far funzionare il meccanismo. **JPN** 駆動部分が滑らかに動くかを確認しながら作業をすめます。 **CHI** 检查机构的运行平稳度和精确度。调整机构。 **POR** Peste a suavidade e precisão do movimento do mecanismo. Opere o mecanismo para que as peças se encaixem. **POL** Sprawdź płynność i dokładność ruchu mechanizmu. Dopracuj mechanizm. **KOR** 구동 부분의 원활한 작동과 정확한 움직임을 확인하세요.

Mechanical models

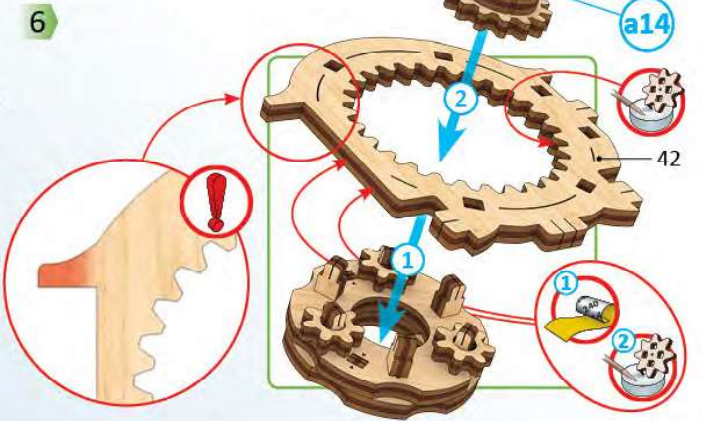
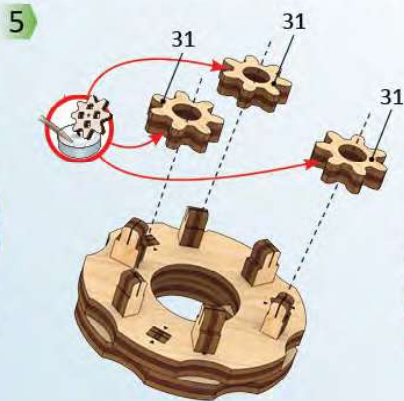
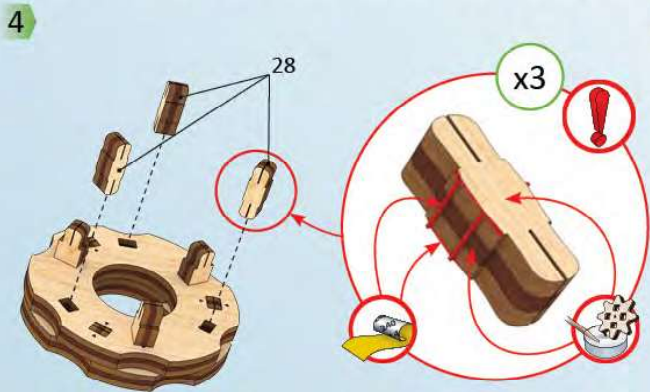
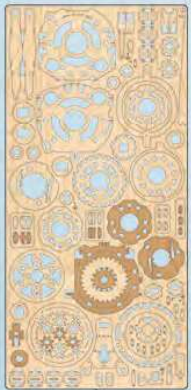
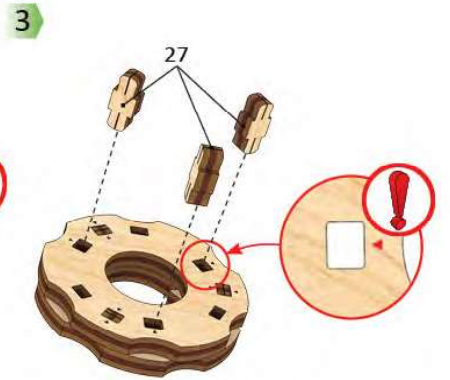
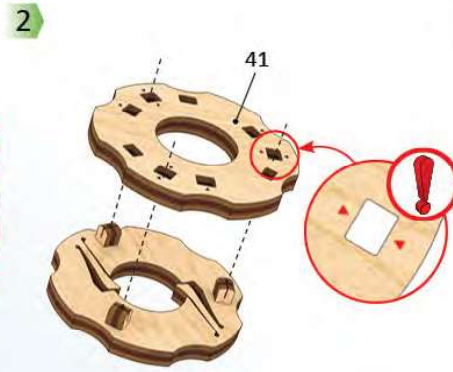
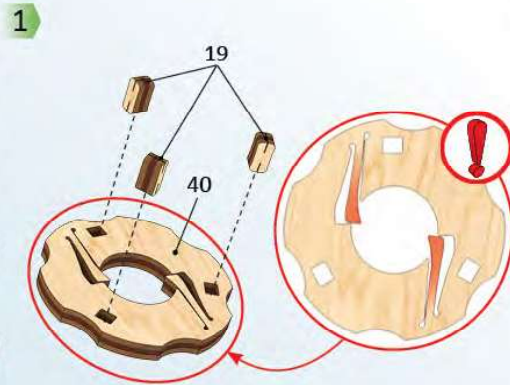
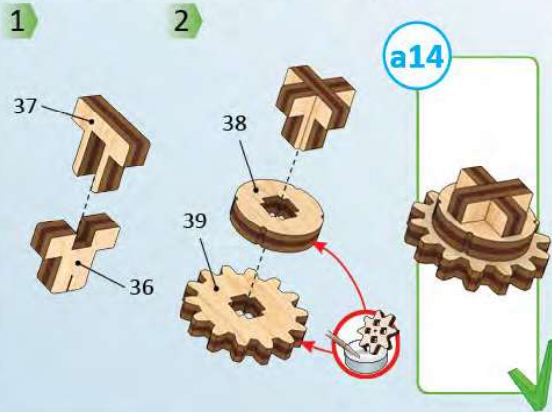

3

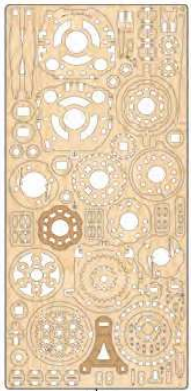
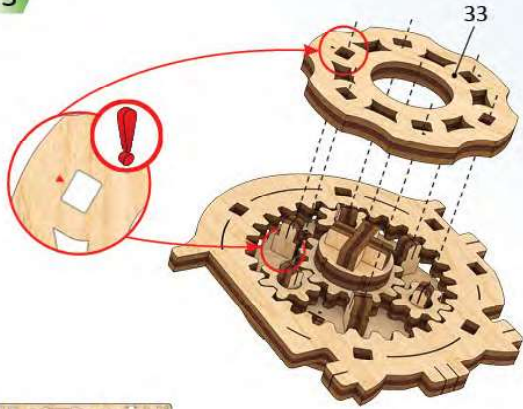

1

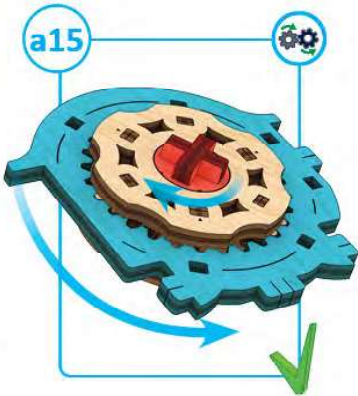

1

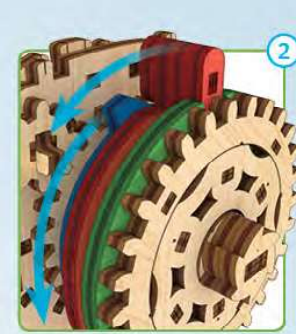
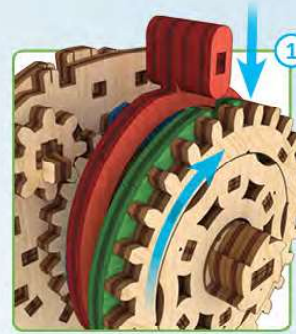

3

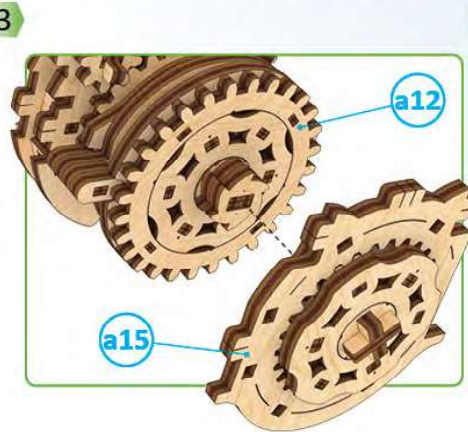

3

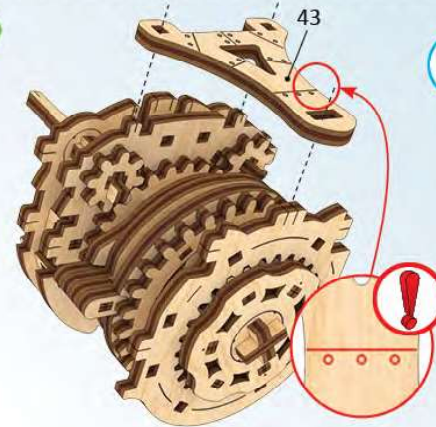

A



Mechanical models

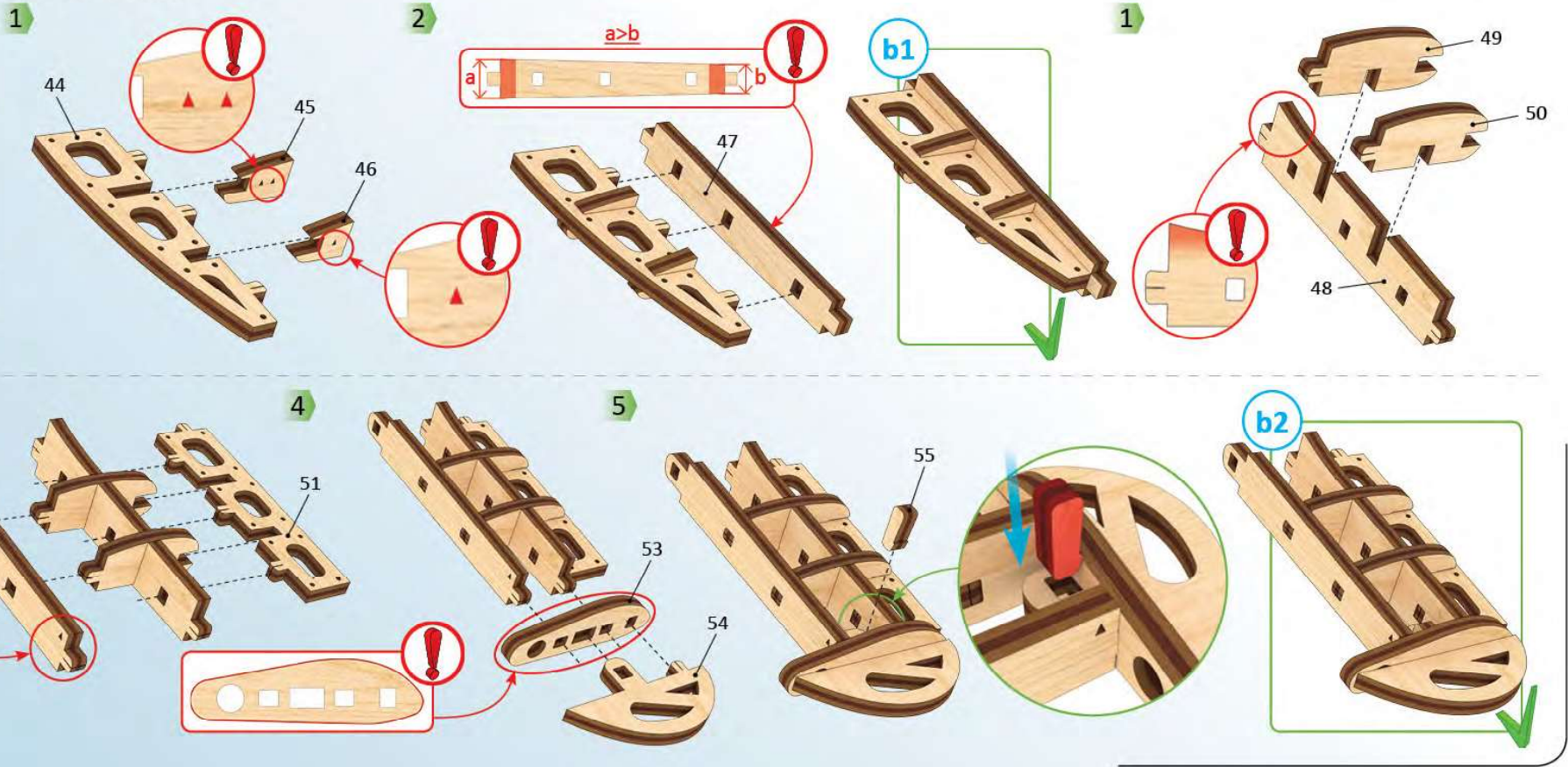

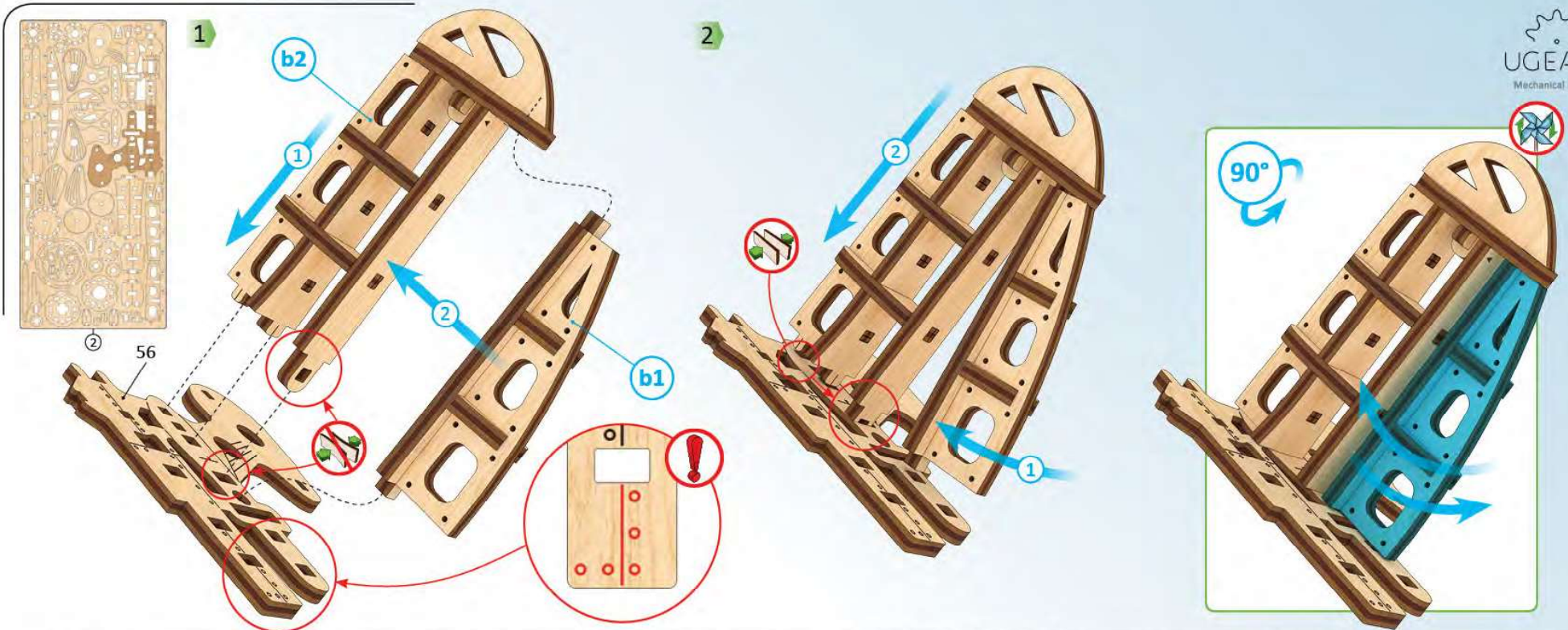

**ENG** The part should be easily rotated (moved). **UKR** Деталь повинна легко крутитися (рухатися).  
**FRA** La pièce doit tourner (se déplacer) aisément. **DEU** Der Teil soll leicht gedreht (bewegt) werden.  
**SPA** La pieza debe ser fácil de girar (mover). **ITA** Il componente deve girare (muoversi) facilmente.  
**JPN** 部品はしっかりと動かなければなりません。 **CHI** 此部件必須容易的旋转(移动)  
**POL** Element powinien łatwo się kręcić (poruszać się). **POR** A peça deve ser facilmente girada (movida). **KOR** 활하게 움직일 수 있어야 합니다.



**ENG** Do not fully press the outer parts (structural frame) together until checking for fit and alignment of internal parts. **UKR** Делкий час не притискайте сильно деталі (рамки конструкції).  
**FRA** Ne pas forcer sur les pièces (cadre de la construction). **DEU** Drücken Sie die Teile (die Rahmen der Konstruktion) momentan nicht stark. **SPA** No presione temporalmente con fuerza las piezas (marco de la estructura). **ITA** Non stringere provvisoriamente i componenti con forza (base della costruzione). **JAP** 内部部品がしっかりと組み立てられる前に外部部品は強く押しながから固定してはいけません。 **CHI** 在检查内部零件的配合和对准之前, 请暂时不要将外部零件(结构框架)完全压在一起。 **POR** Não pressione totalmente as peças externas (estruturais) até verificar que as peças externas estão bem encaixadas e alinhadas. **POL** Tymczasowo nie dociskaj elementów (ramy konstrukcji). **KOR** 아직은 외부의 틀을 완전히 눌러서 고정하면 안됩니다. 다른 부품을 먼저 끼우세요.

Mechanical models

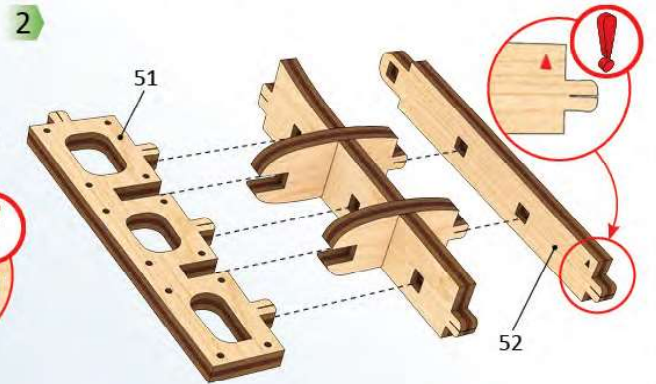
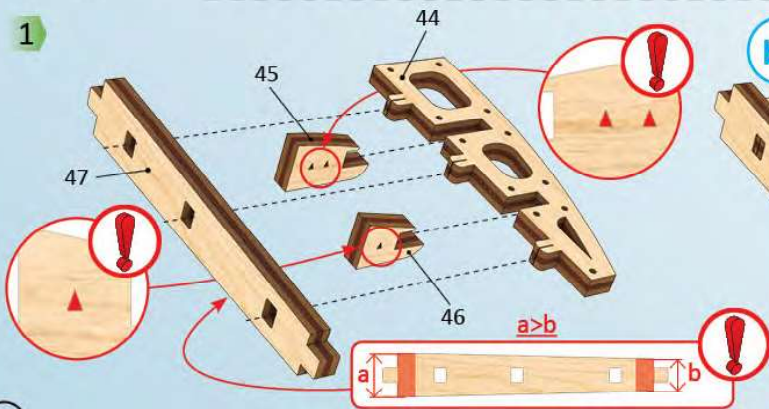
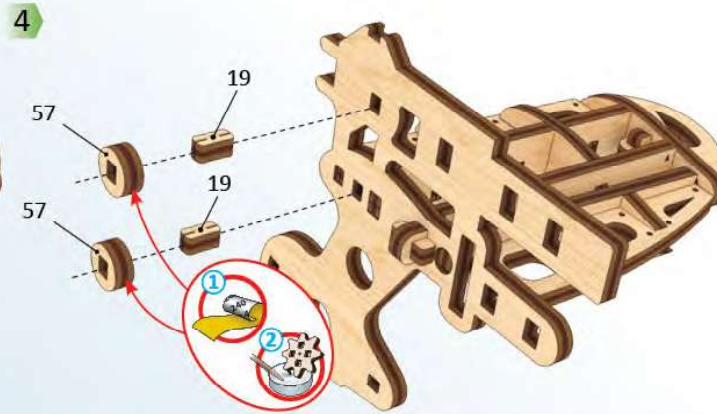
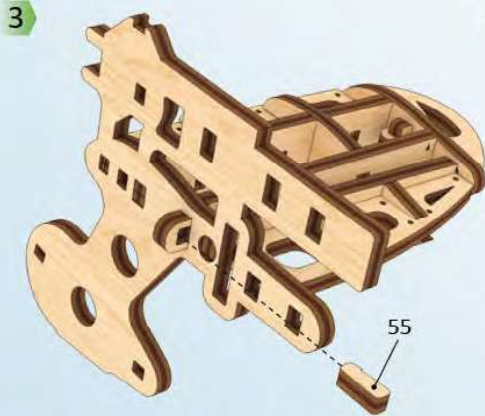

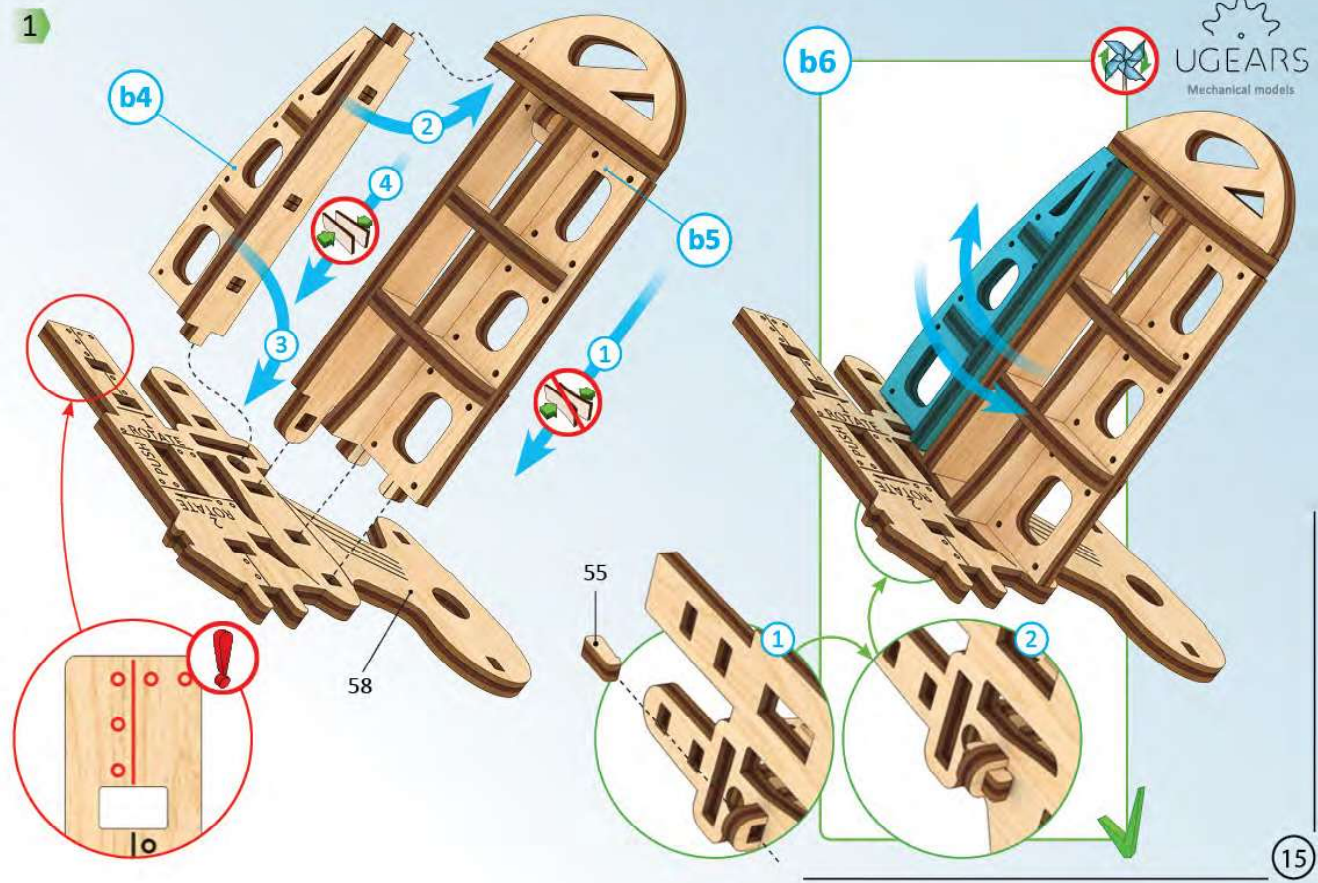
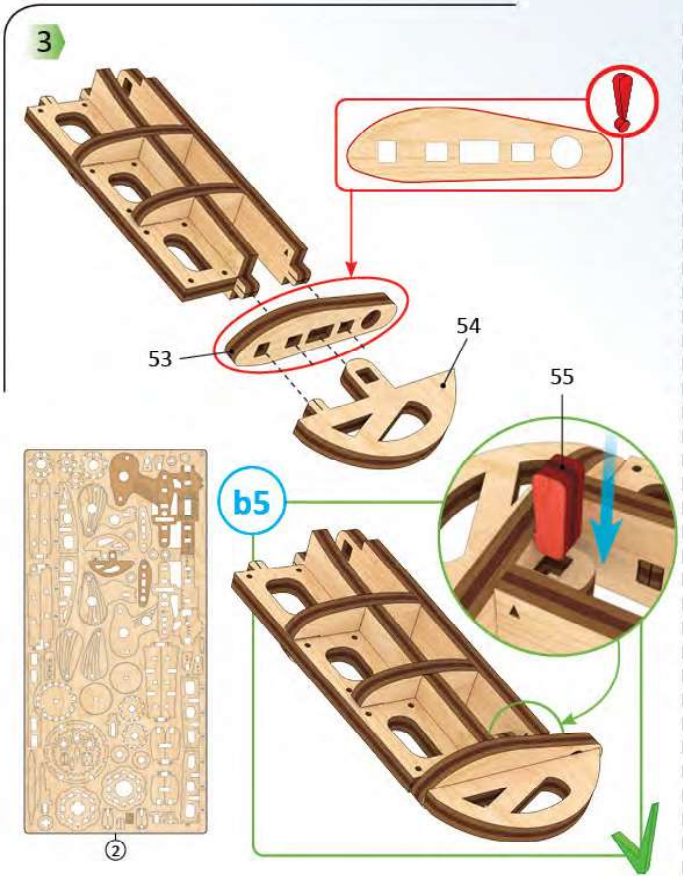

Mechanical models

1

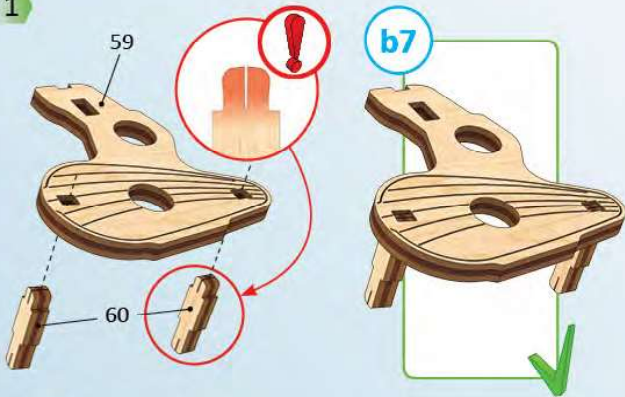

1

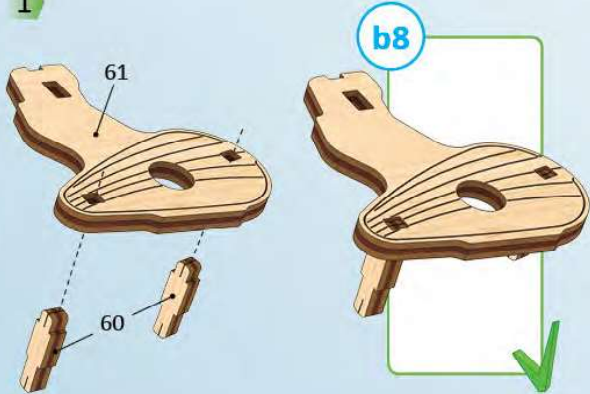

1

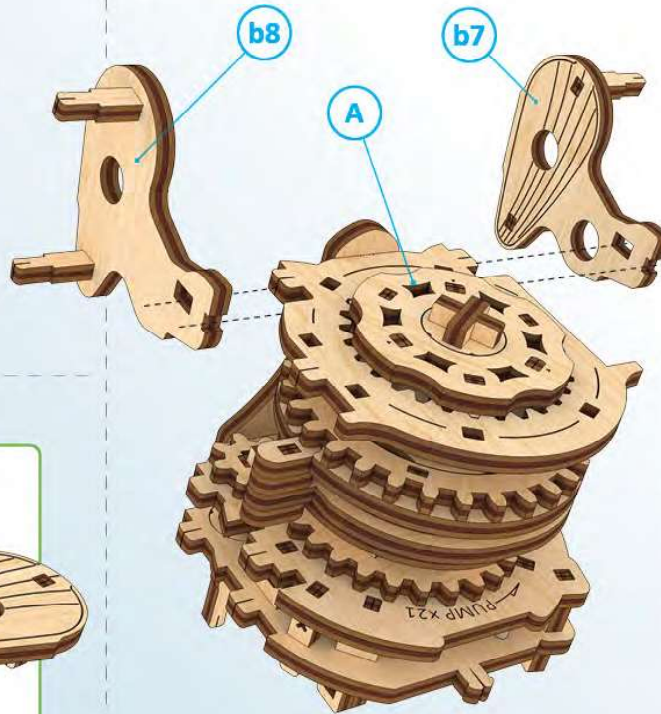

1

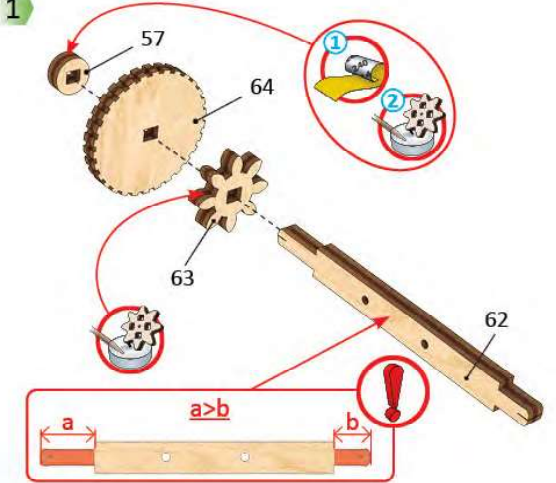

b9

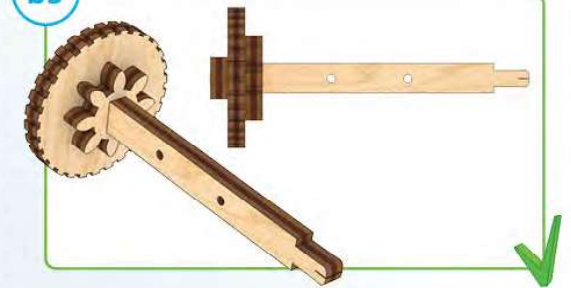



2

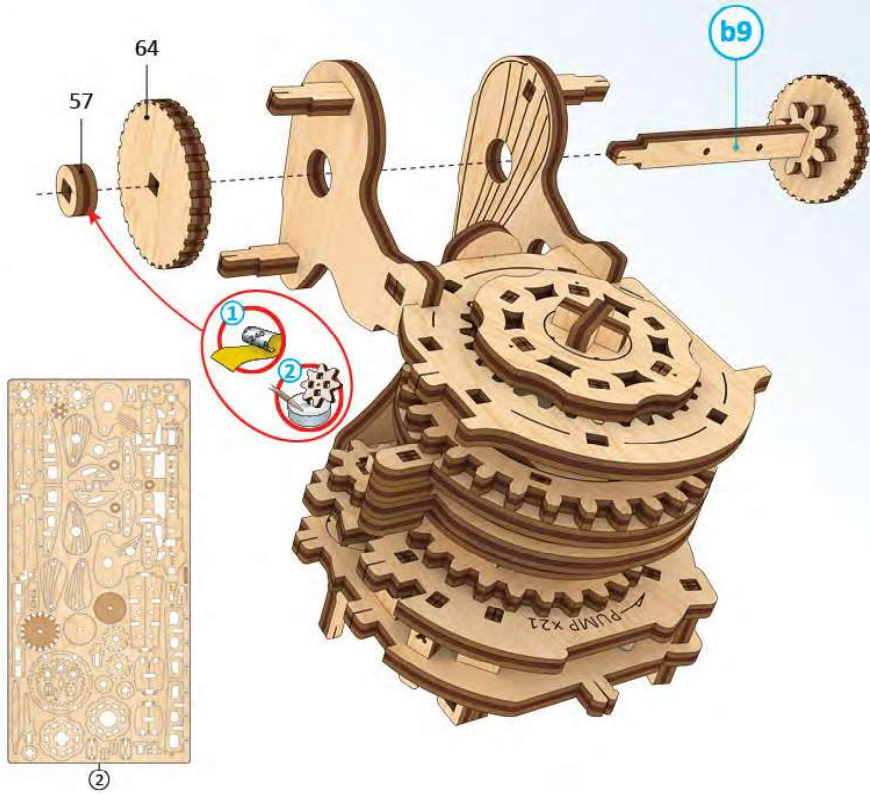

b9

b10

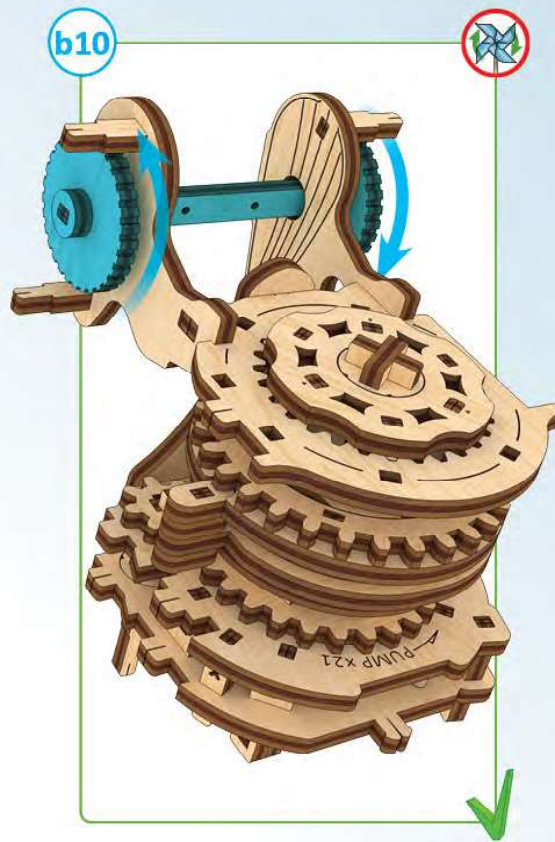

1

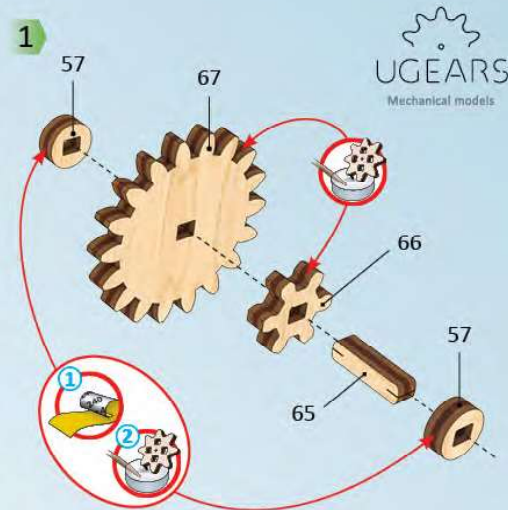

b11

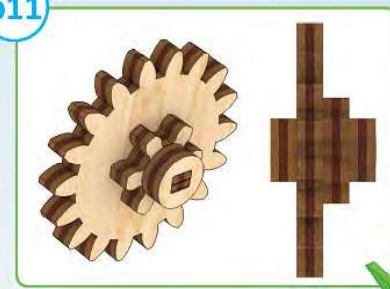

Mechanical models



1

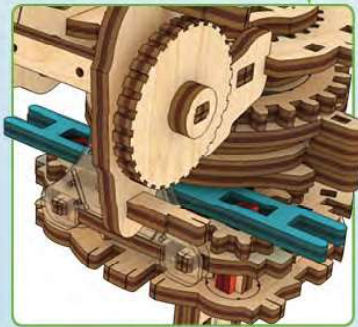
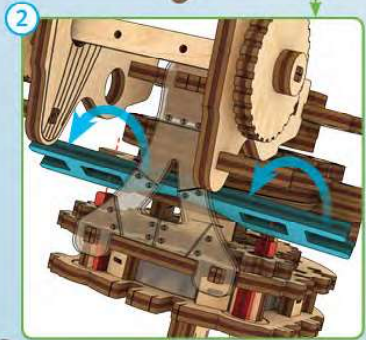
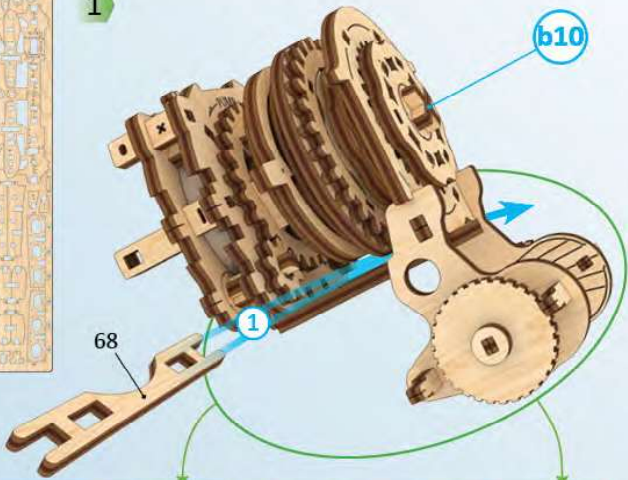

2

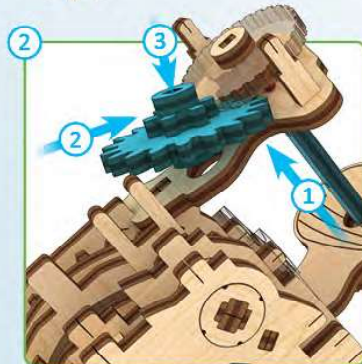
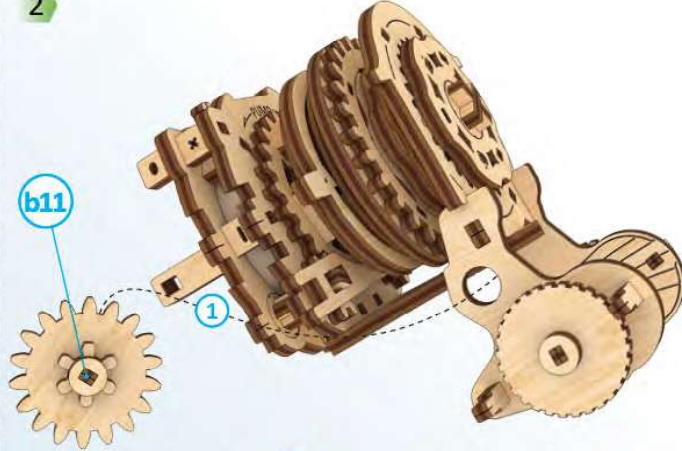

b12



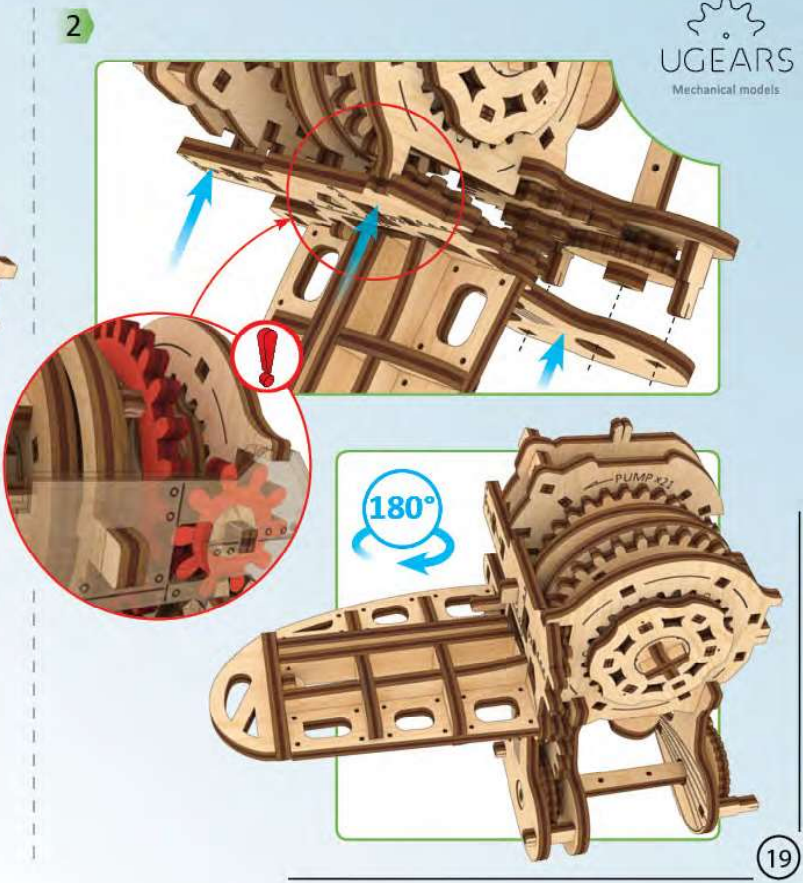
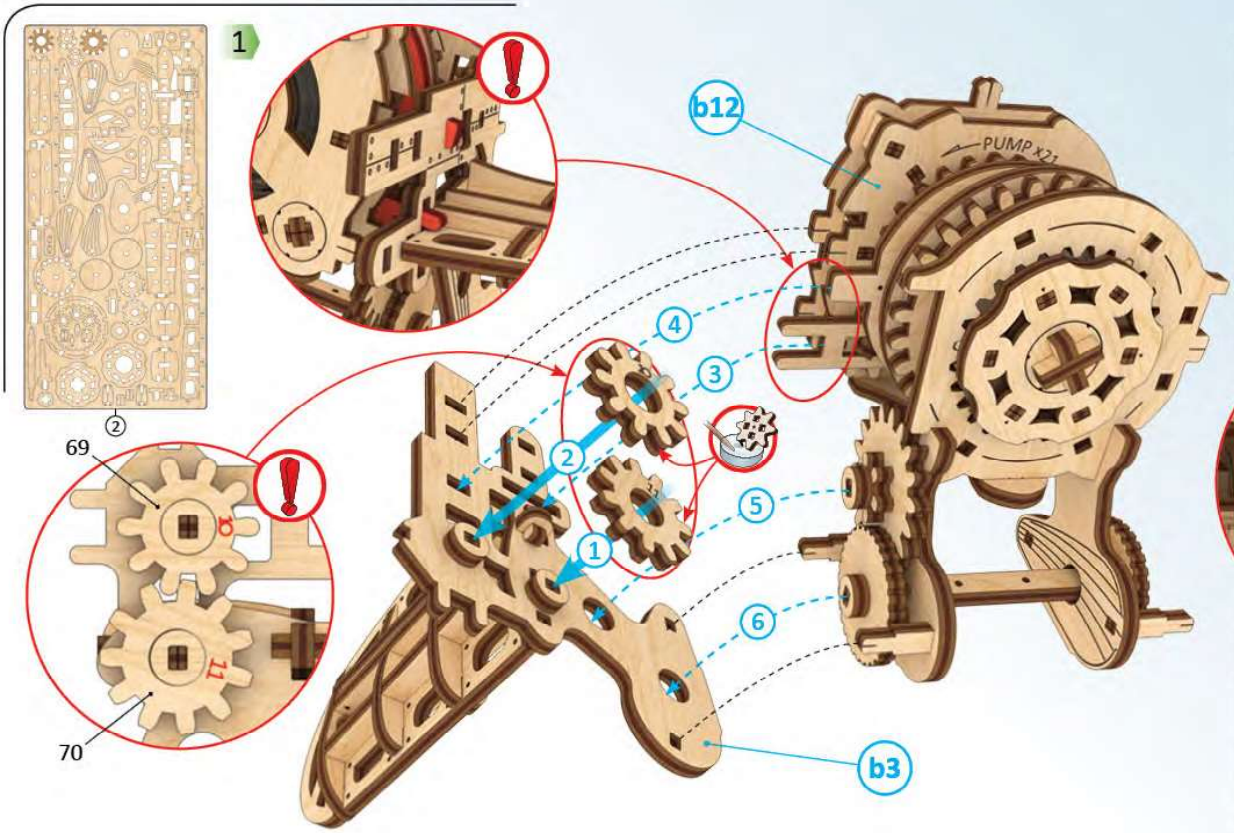

Mechanical models

2

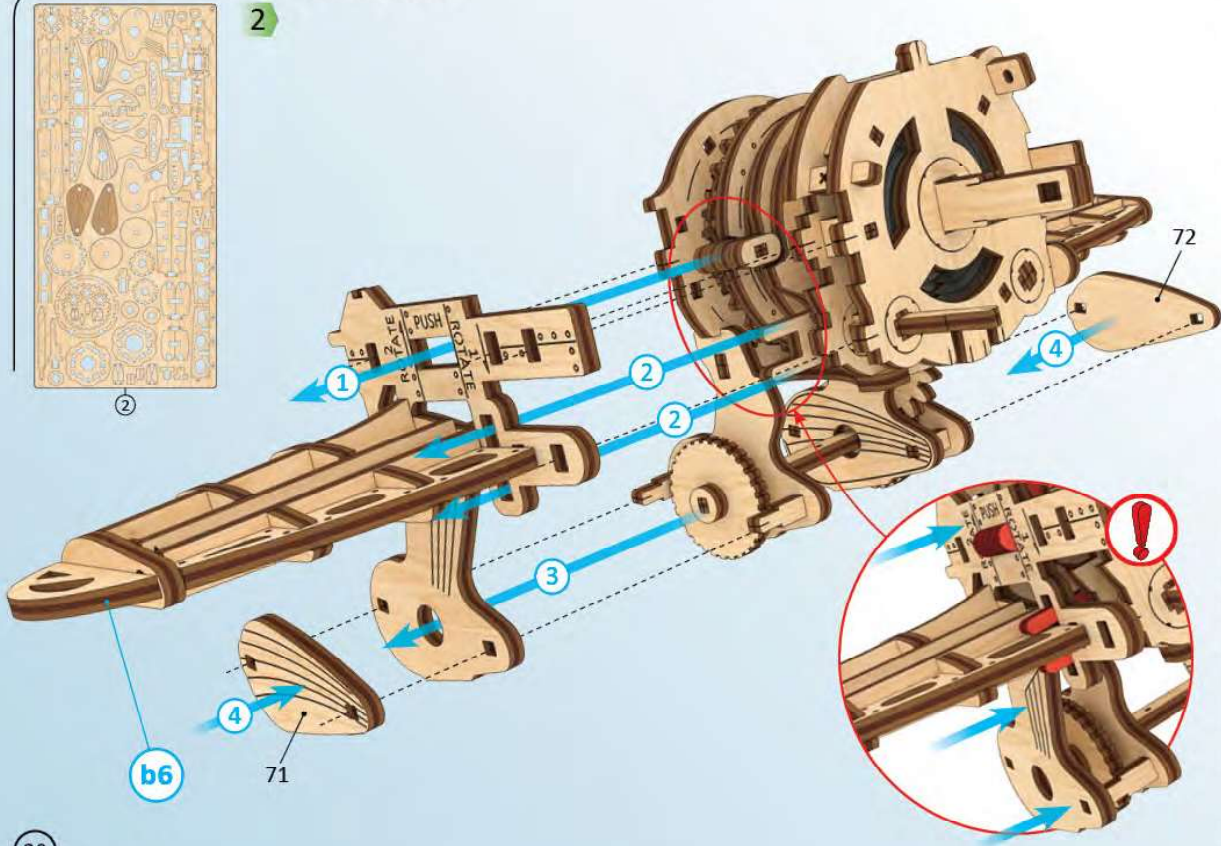

3

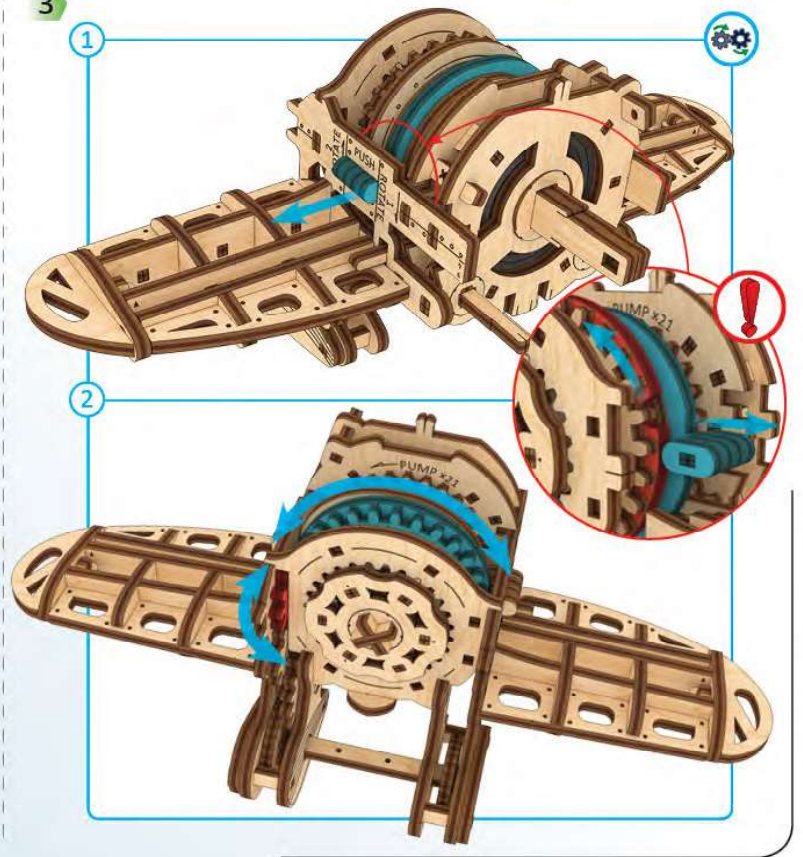

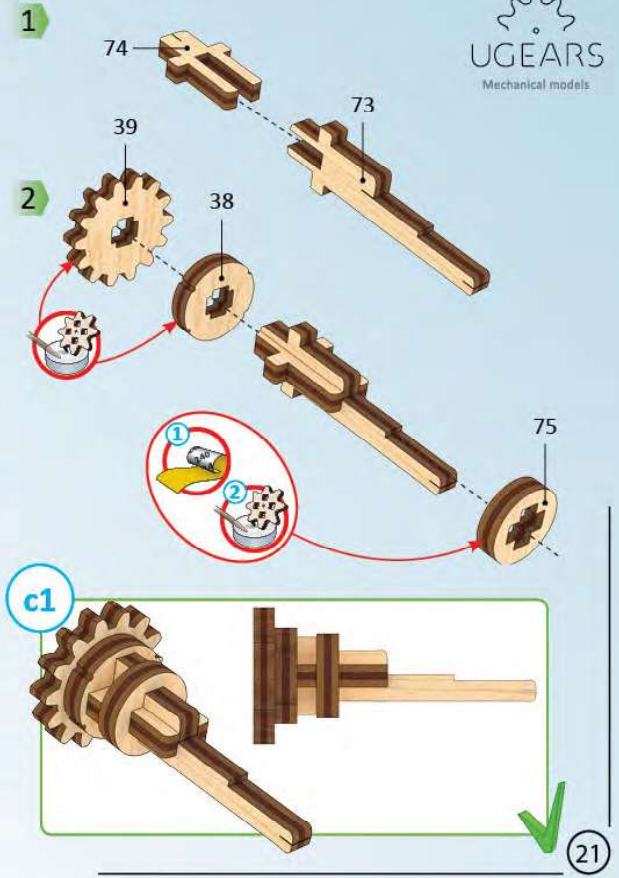
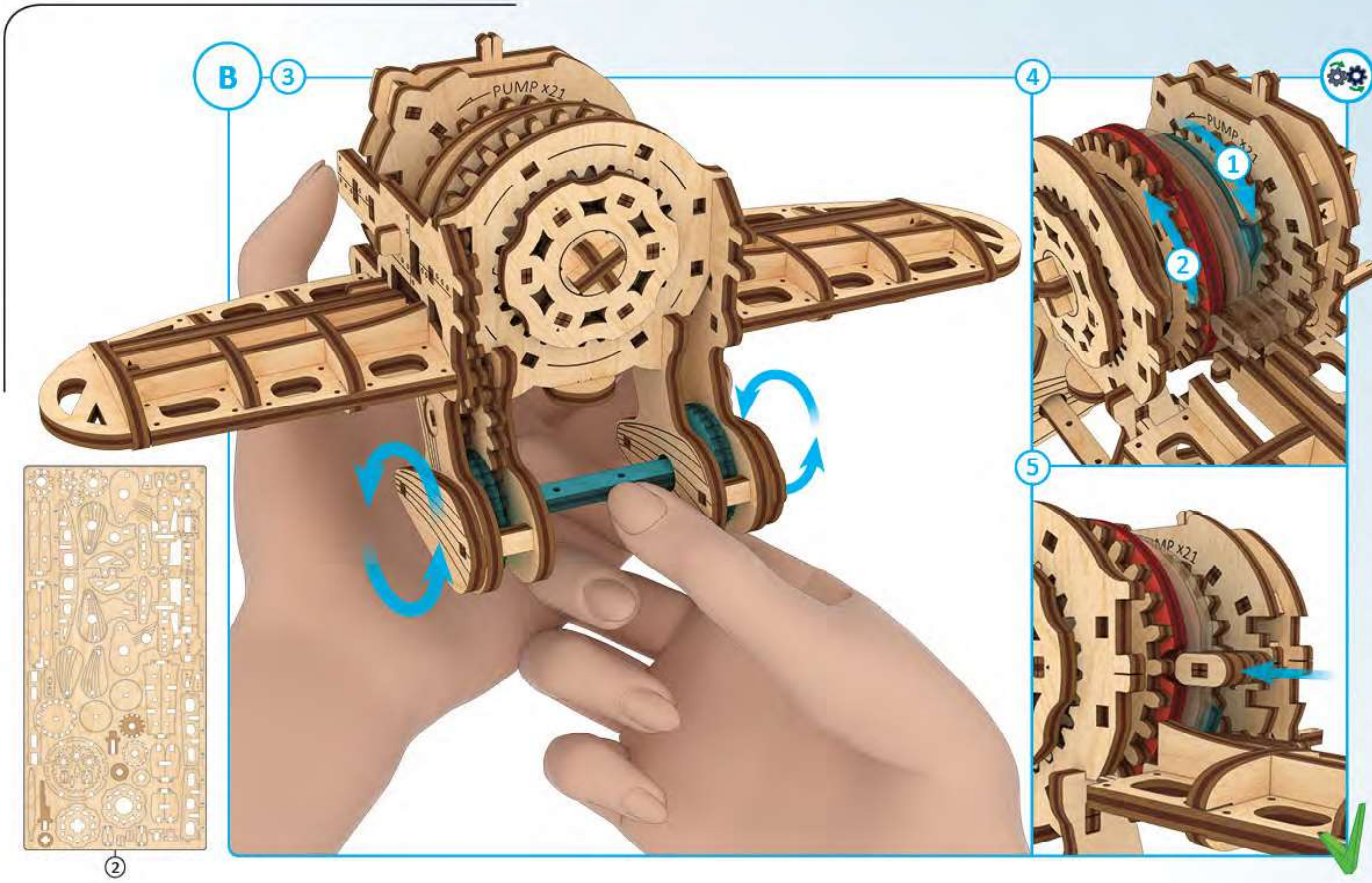

Mechanical models



1

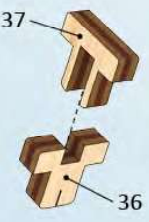

2

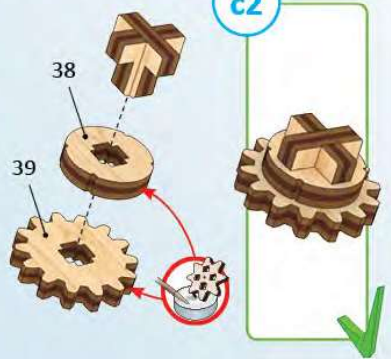

1

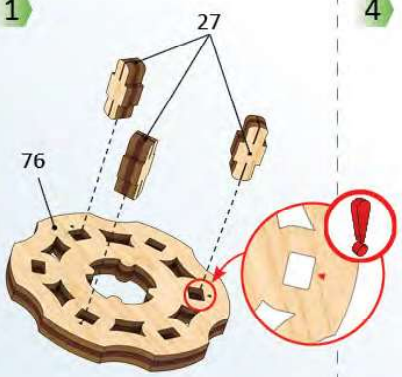

4

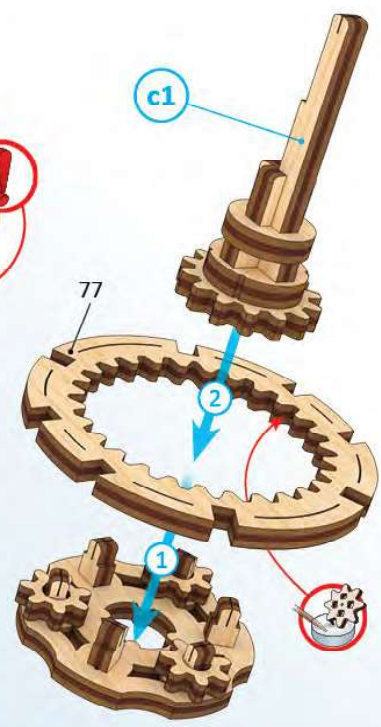

5

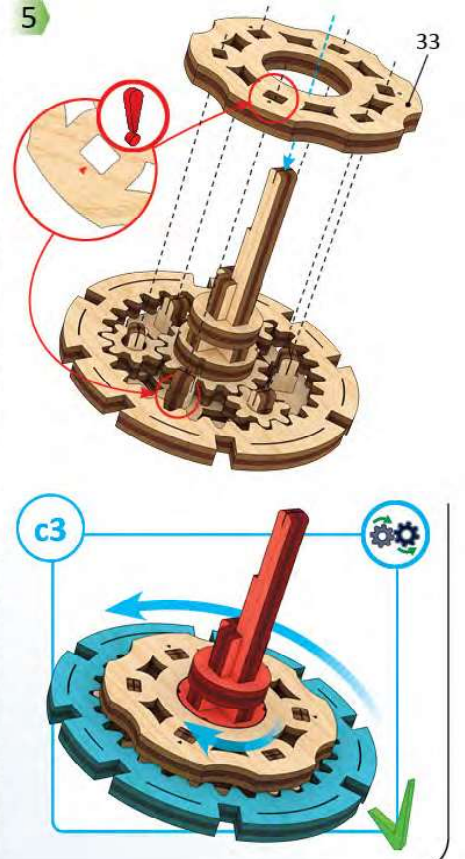

2

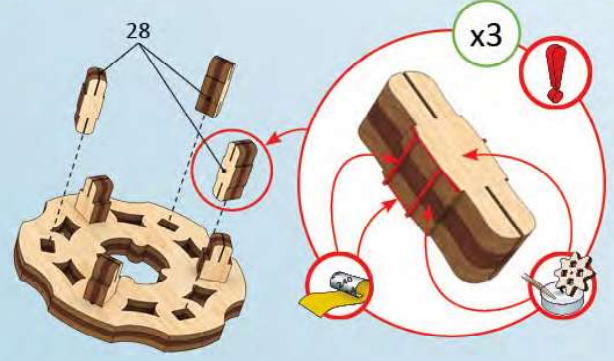

3

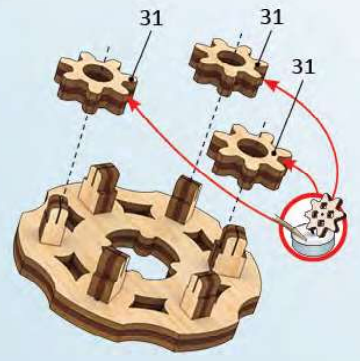

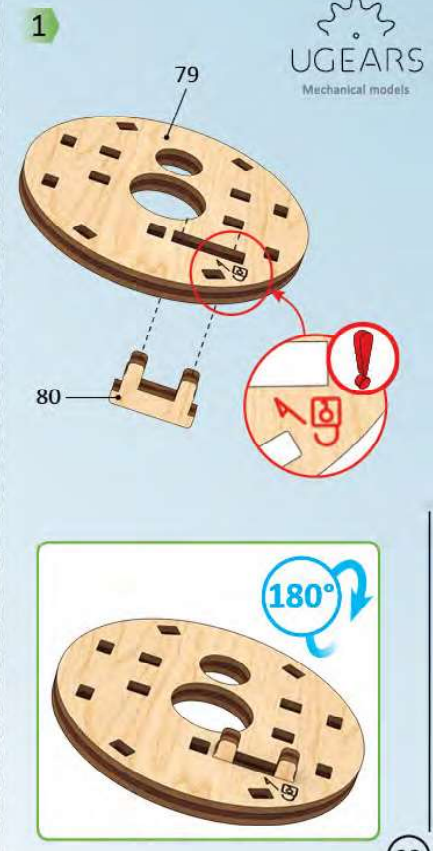
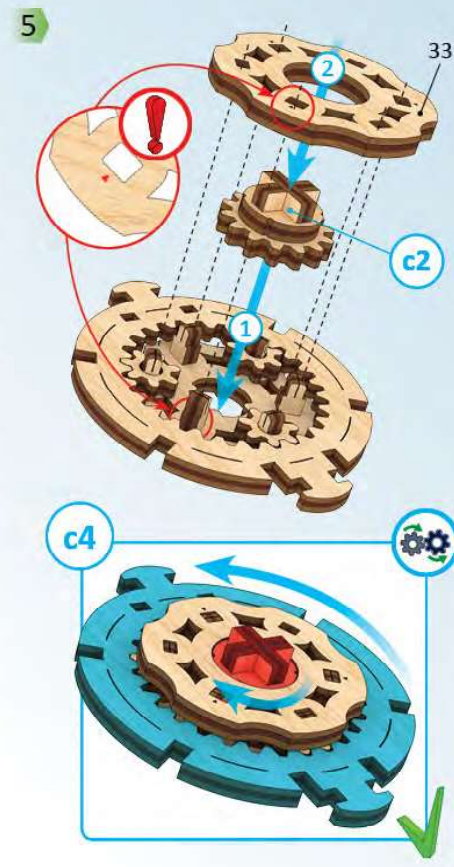
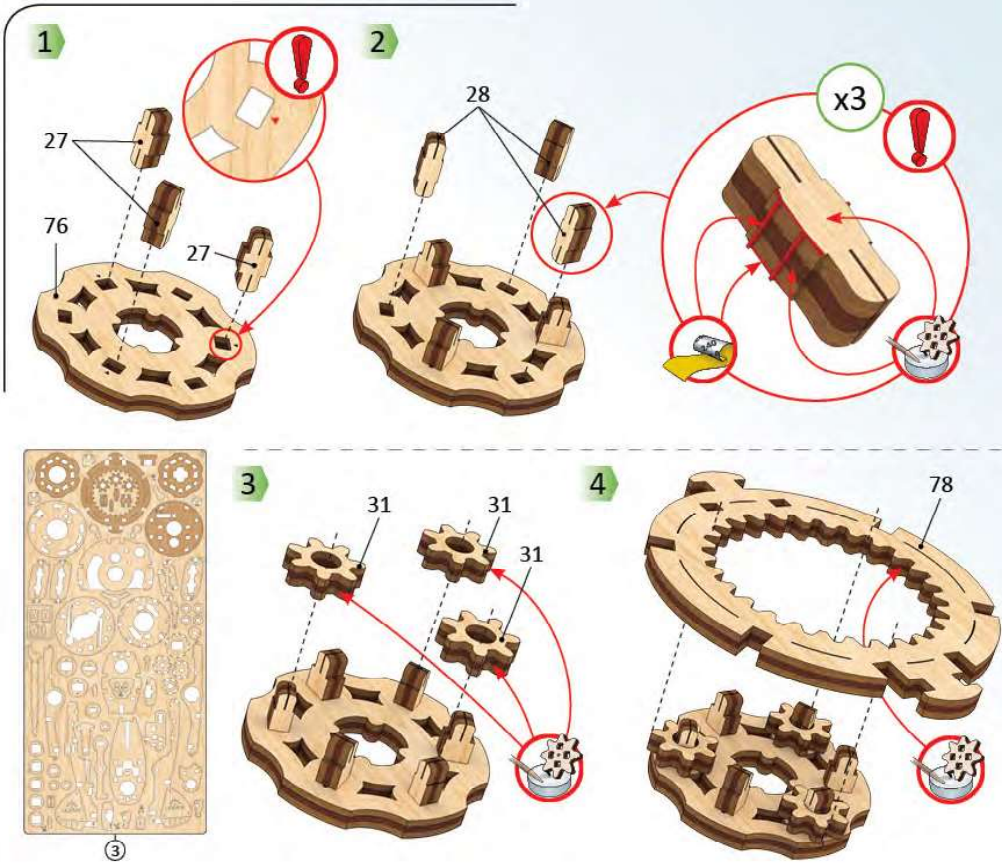

Mechanical models

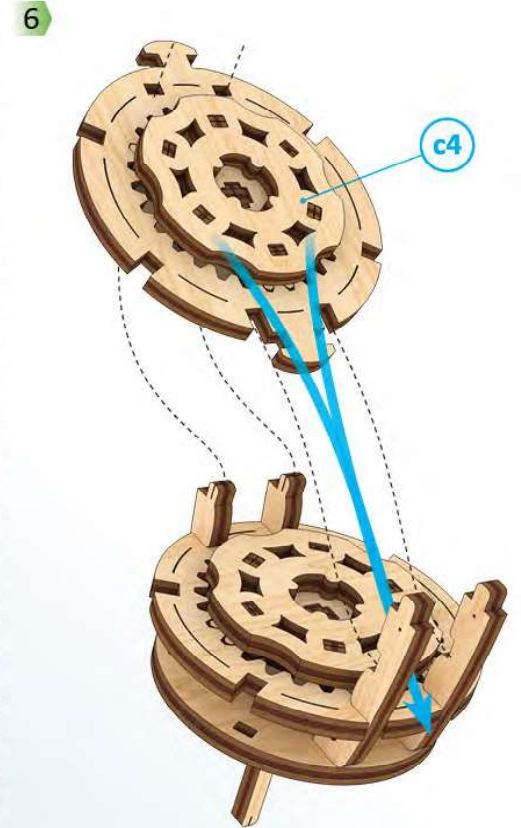
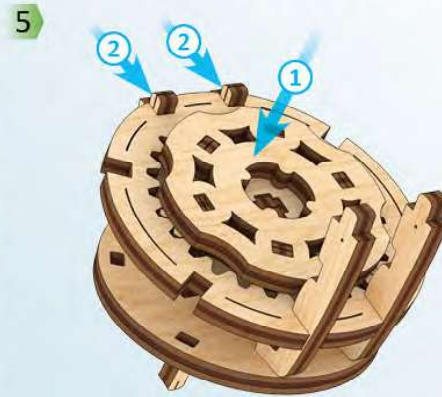
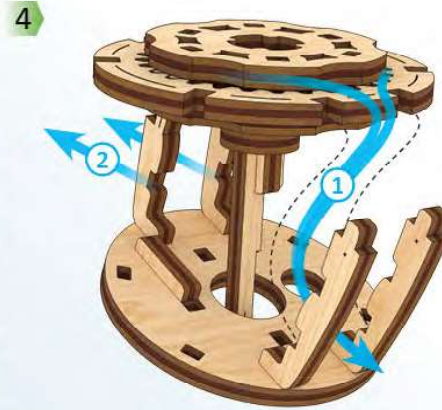
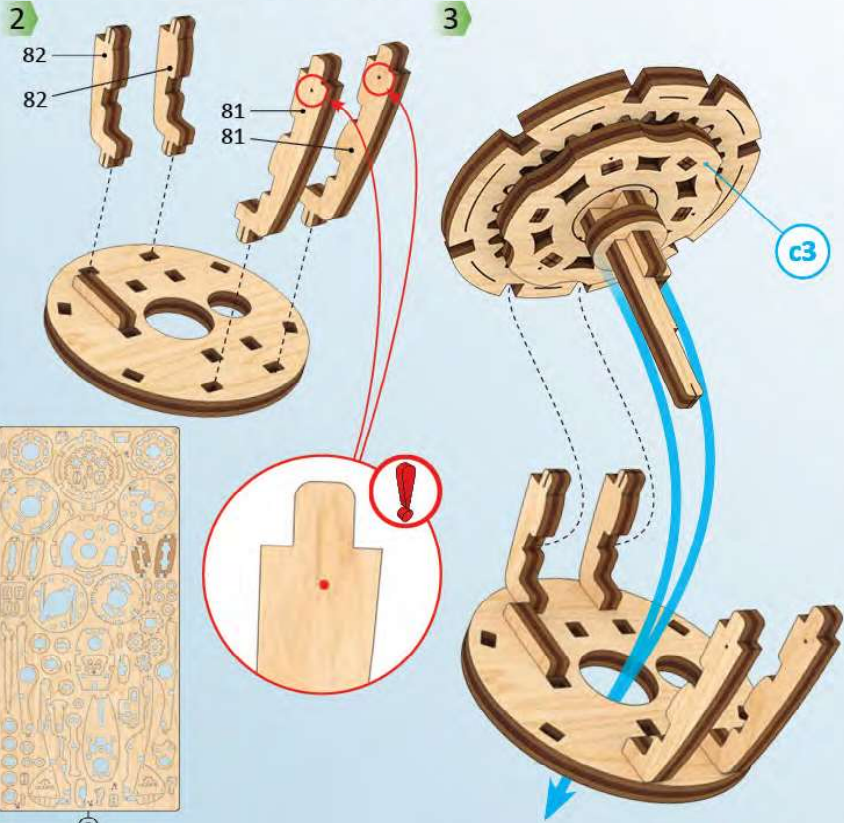



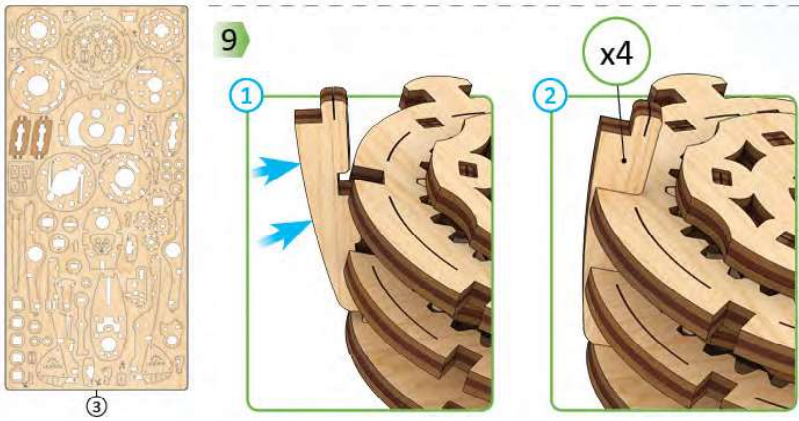
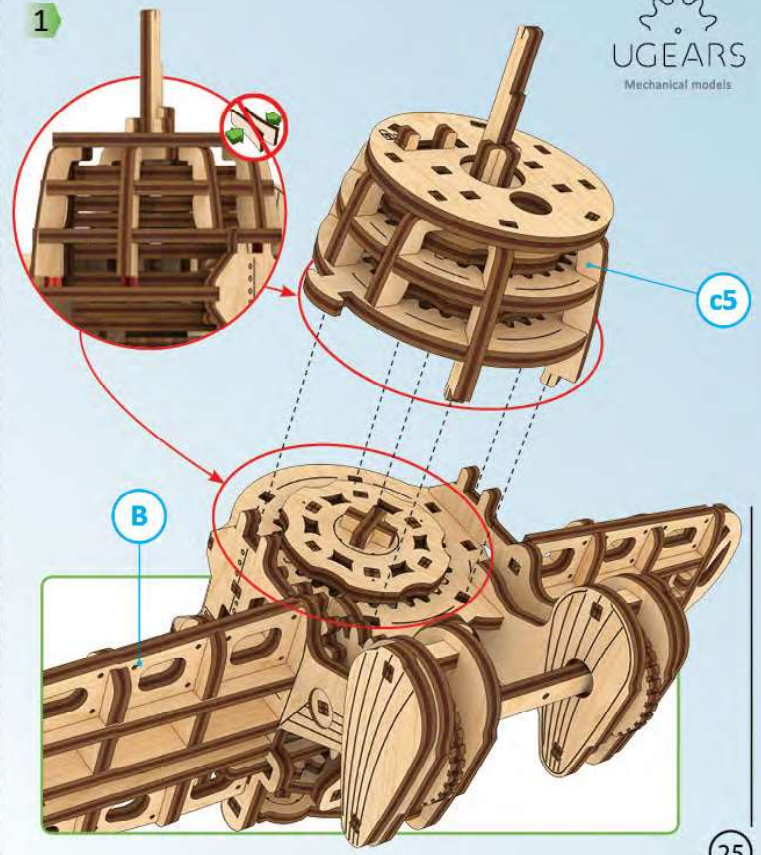
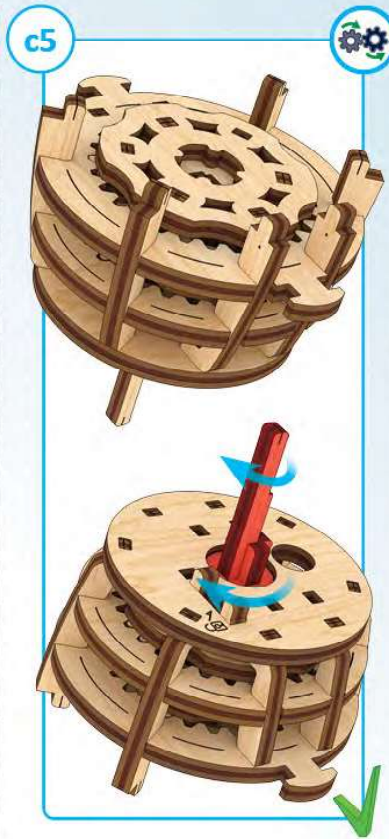
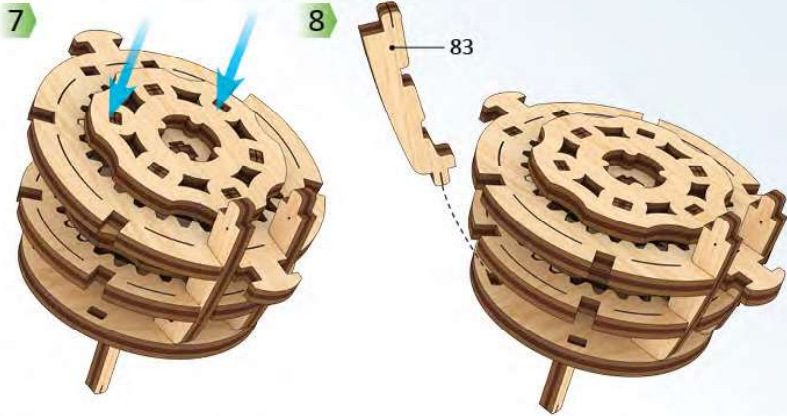

Mechanical models



2

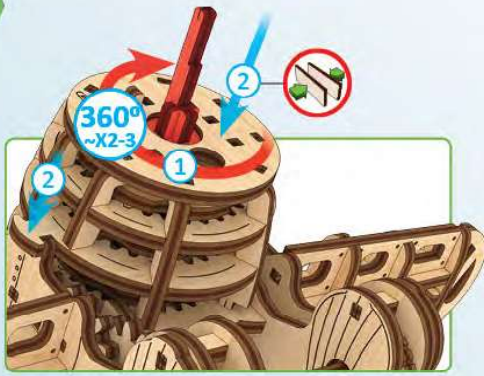

3

1

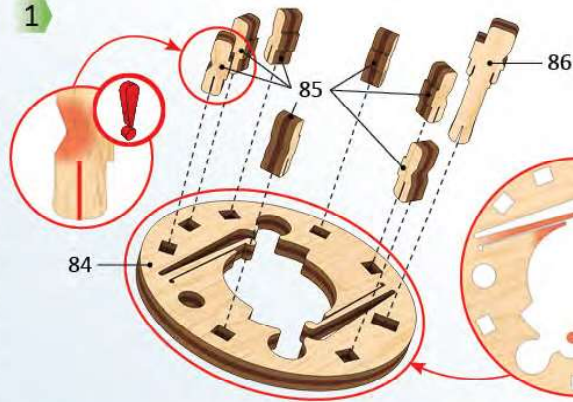

2

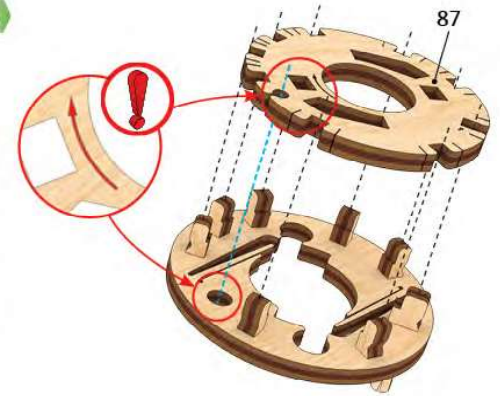

C

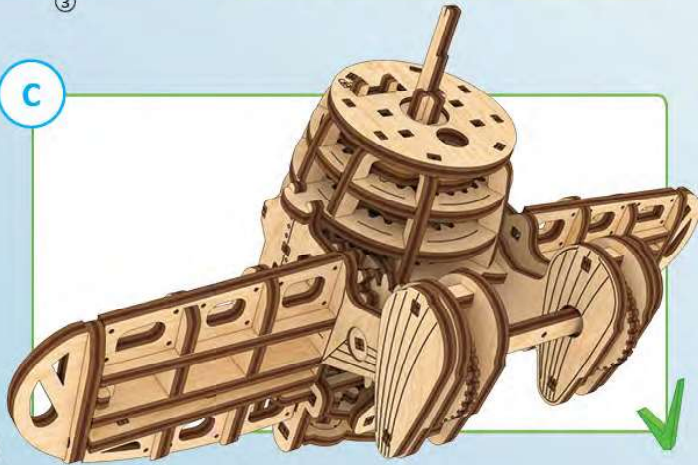

26

1

d1



d2

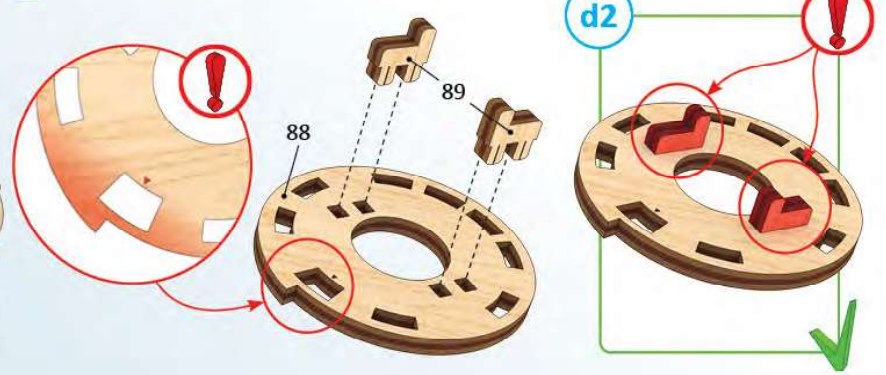

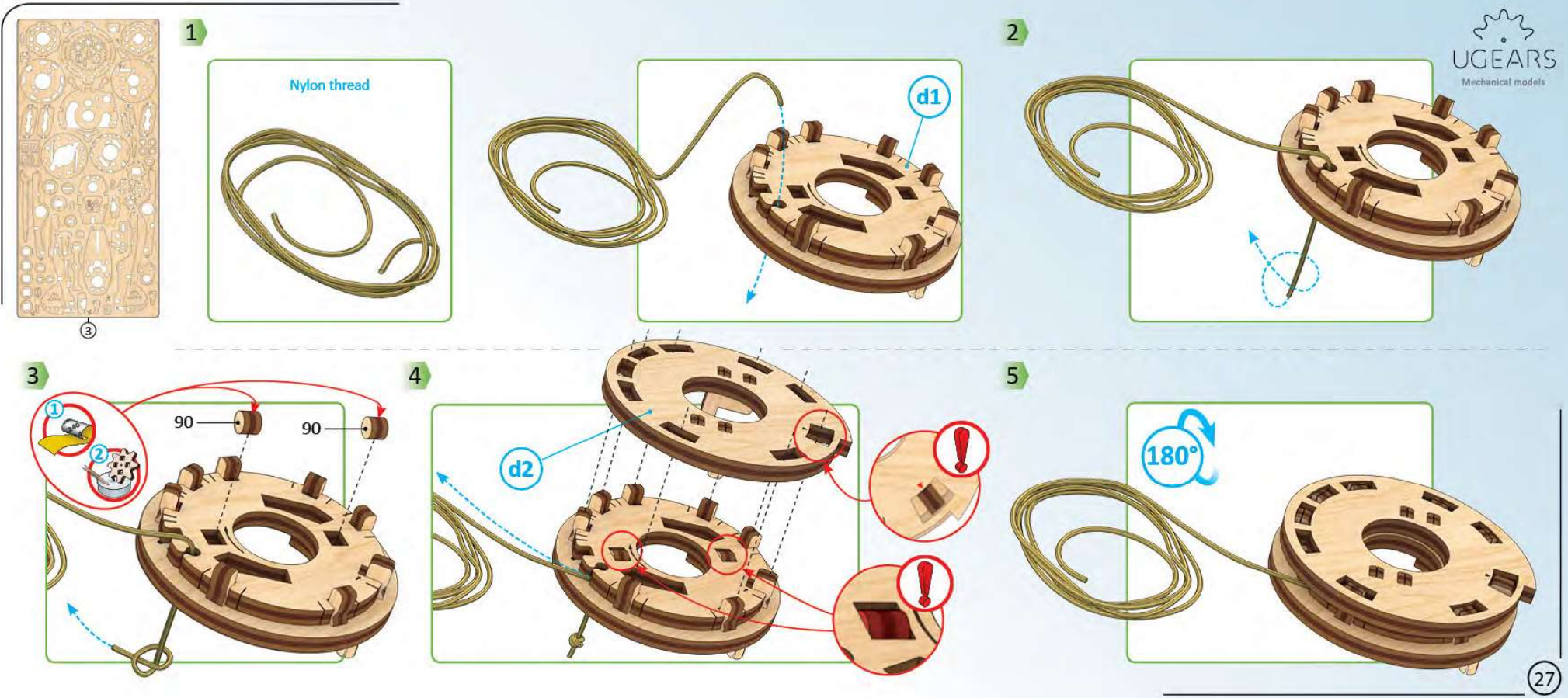

Mechanical models

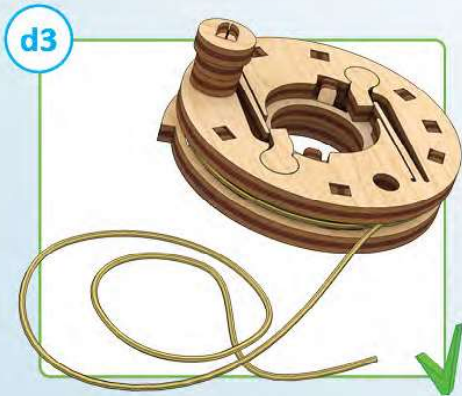
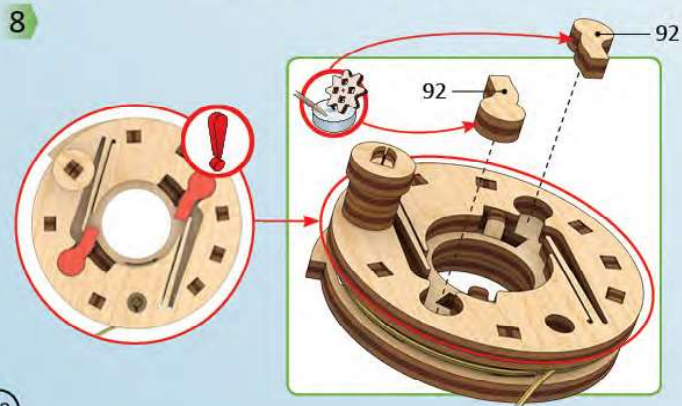
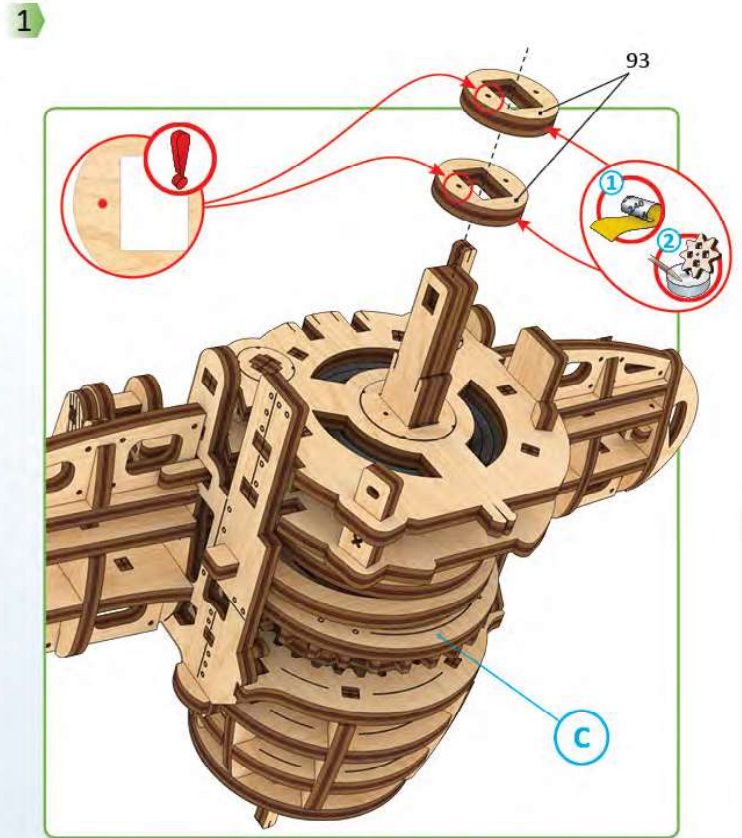
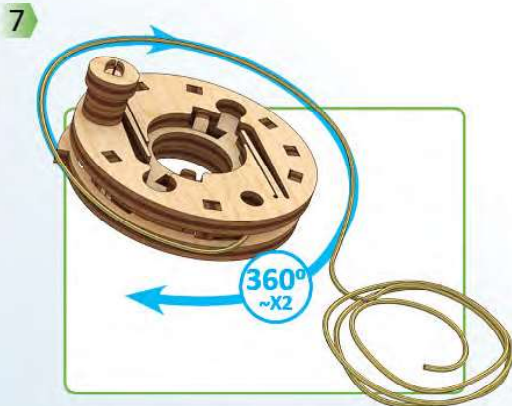
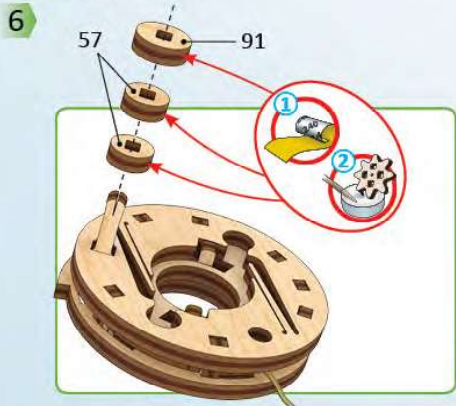

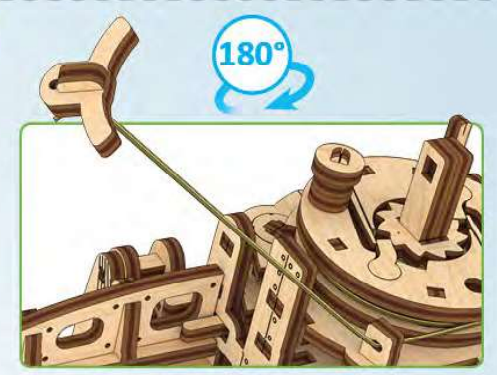
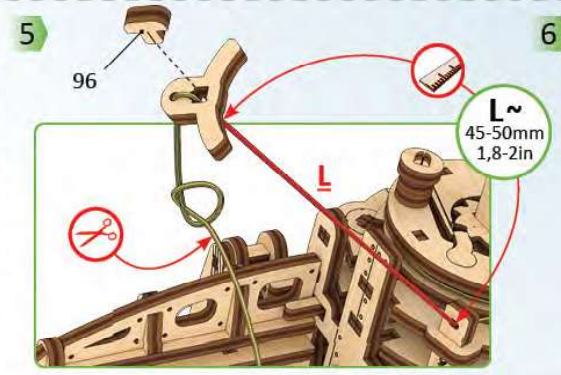
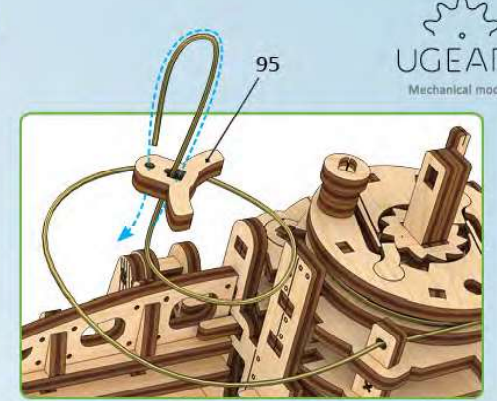
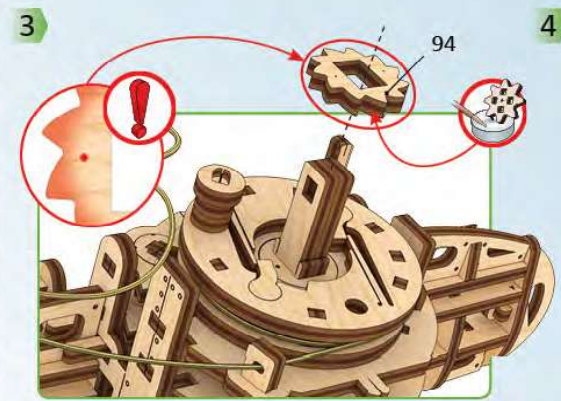
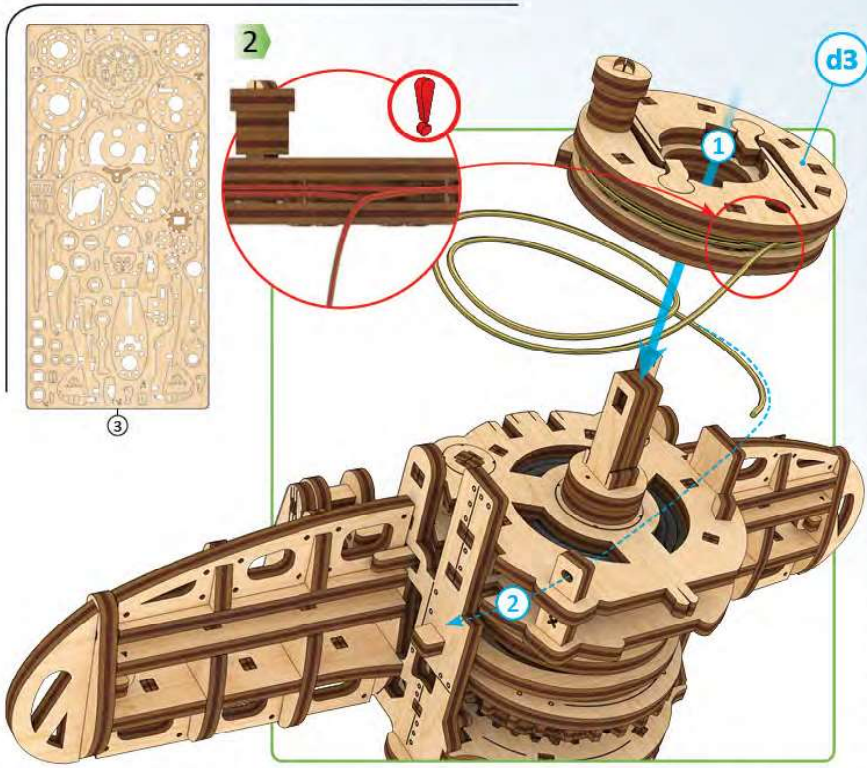

 **ENG** Check size. **UKR** Переаітрі розмір. **FRA** Vérifiez la dimension. **DEU** Prüfen Sie die Größe. **SPA** Compruebe el tamaño. **ITA** Controllare le dimensioni. **JPN** サイズをエックしてください。 **CHI** 測量尺寸。 **POR** Verifique o tamanho. **POL** Sprawdz rozmiar. **KOR** 크기를 확인해 주세요.

 **ENG** Cut (rubber-band, thread, etc.). **UKR** Відріжте (гумку, нитку, тощо). **FRA** Couper (ruban élastique, fil, etc.). **DEU** Schneiden (Gummiband, Faden, etc.). **SPA** Cortar (goma elástica, hilo, etc.). **ITA** Tagliare (fascia in gomma, filettatura, ecc.). **JAP** カットしてください。(輪ゴム、糸など)。 **CHI** 切割 (橡皮筋、线等)。 **POR** Corte (elástico, fio, etc.). **POL** Utnij (gumkę, nitkę, itd.). **KOR** 잘단(고무밴드, 이우시계 등)



Mechanical models

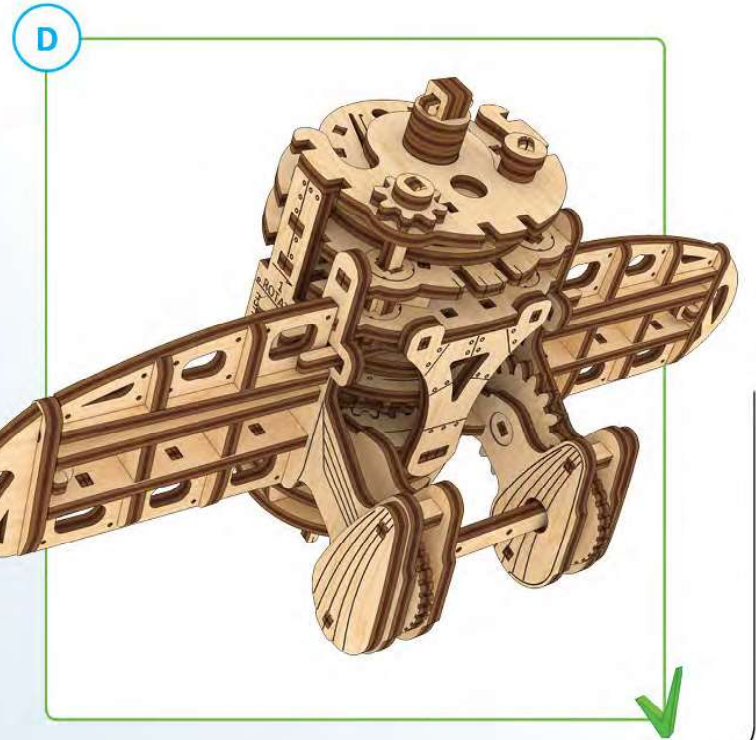
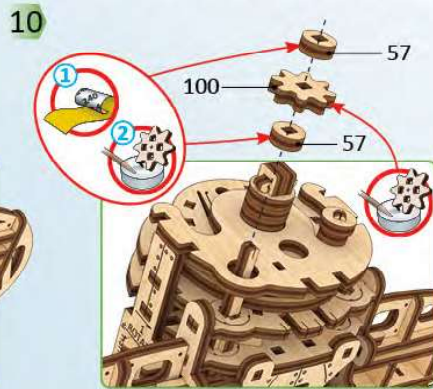
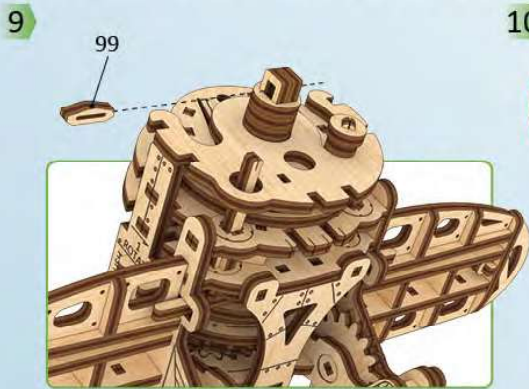
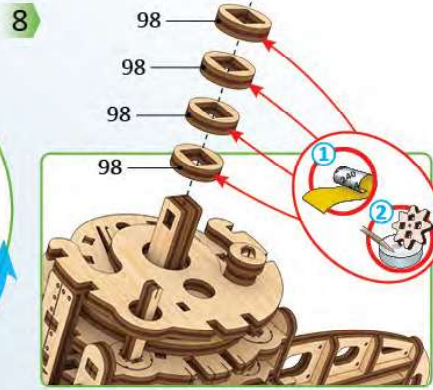
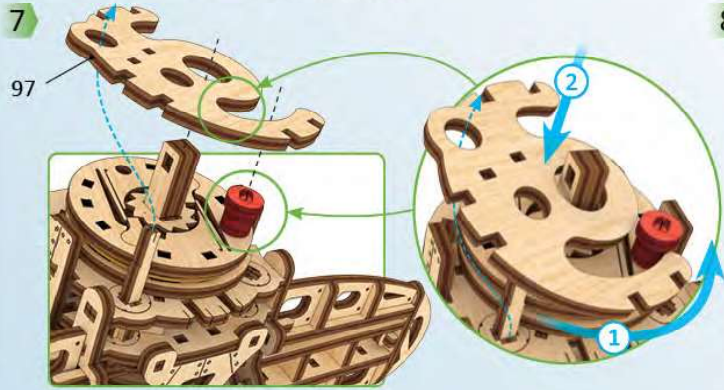

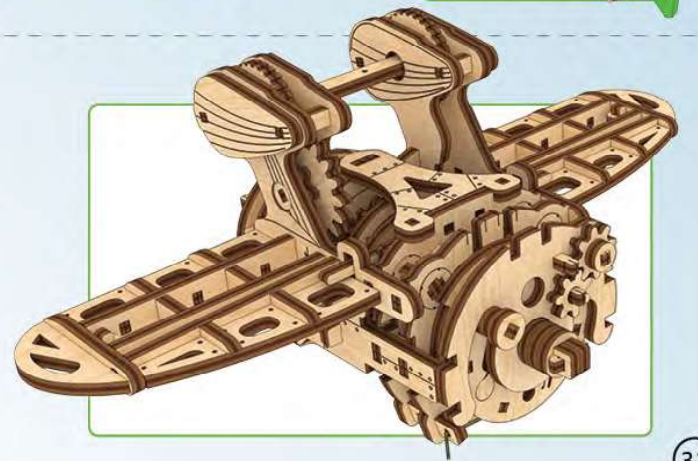
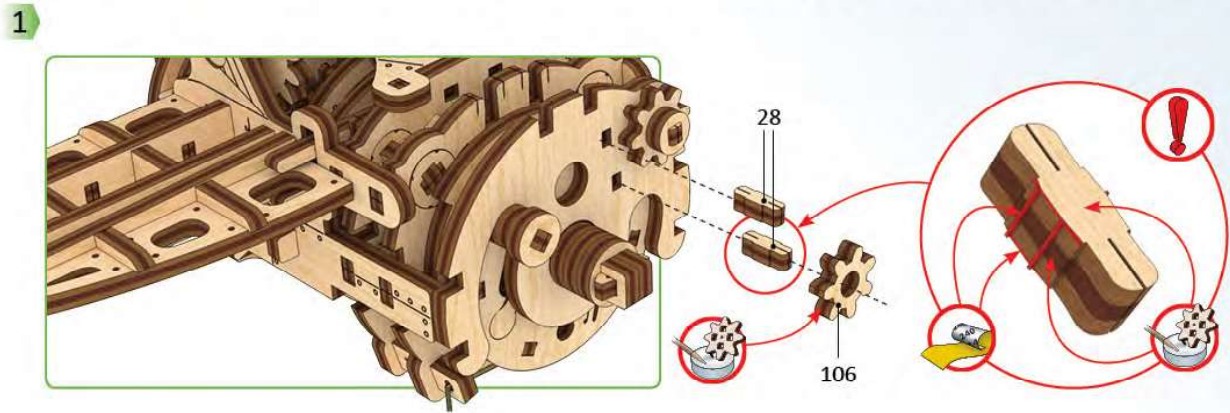
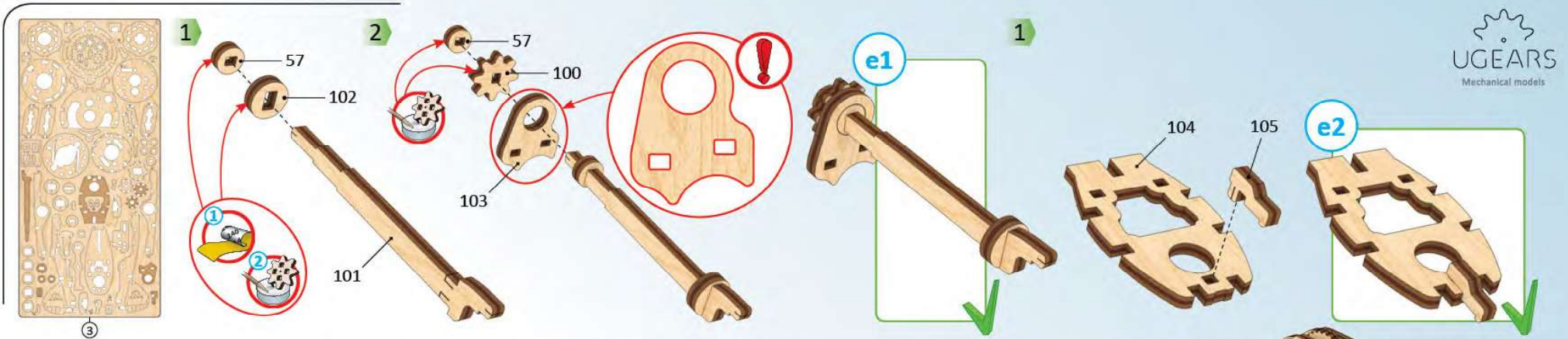

2

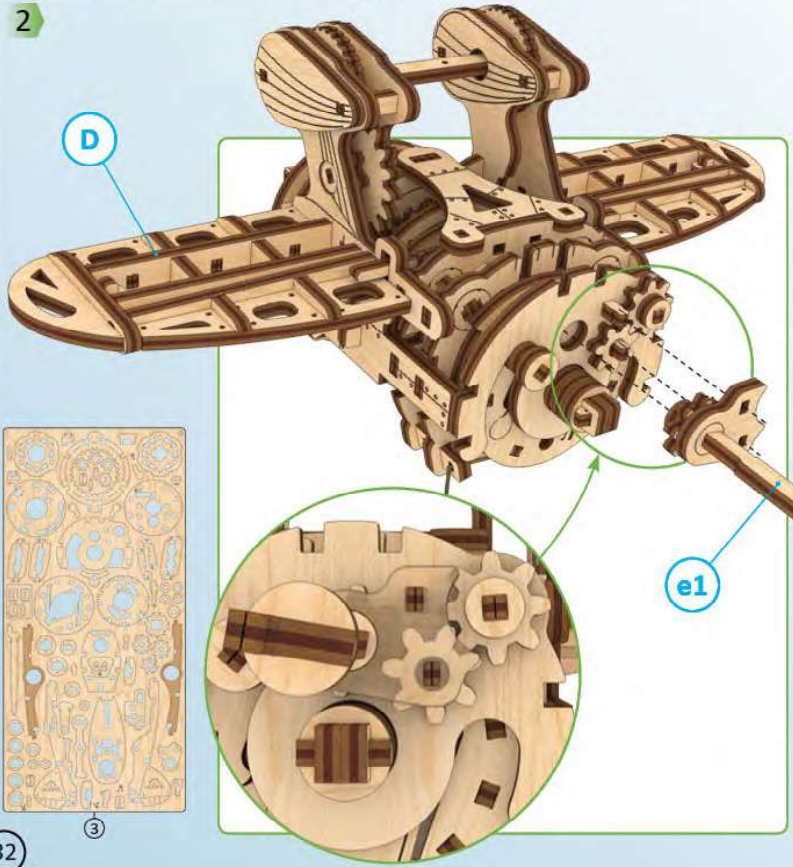

3

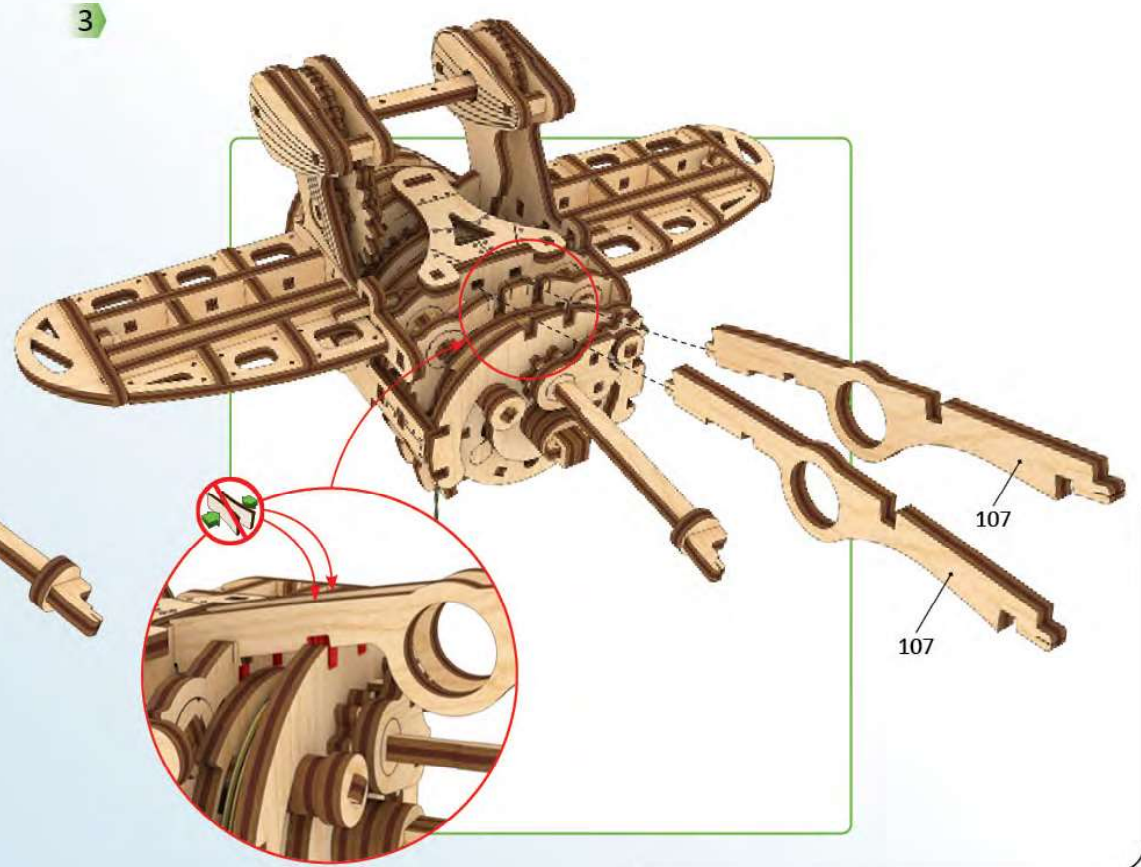



4

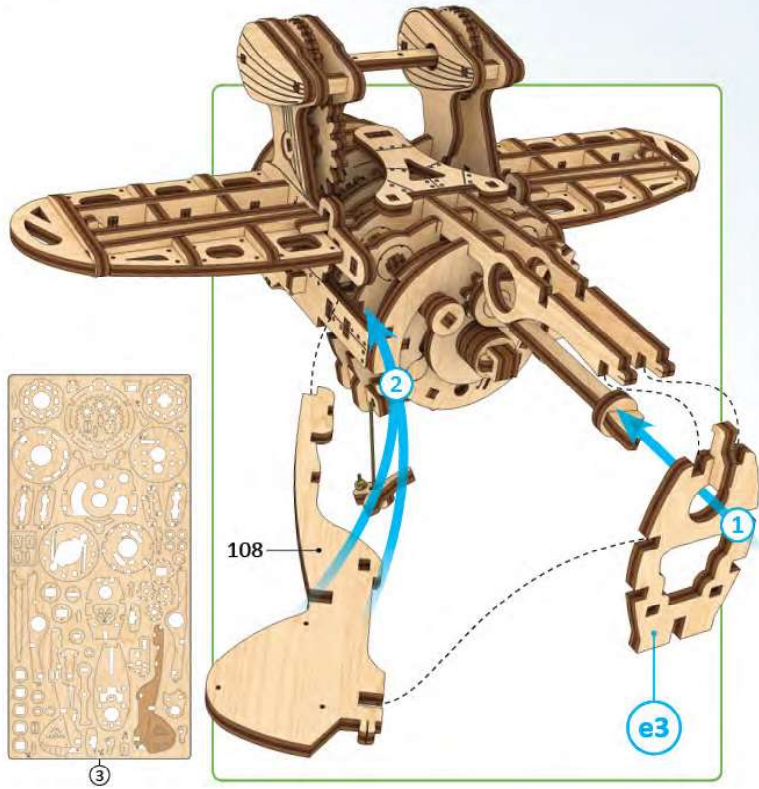

5

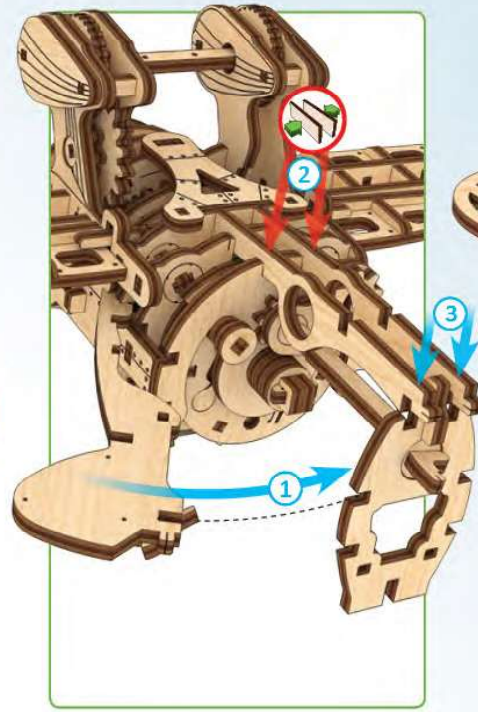

e4

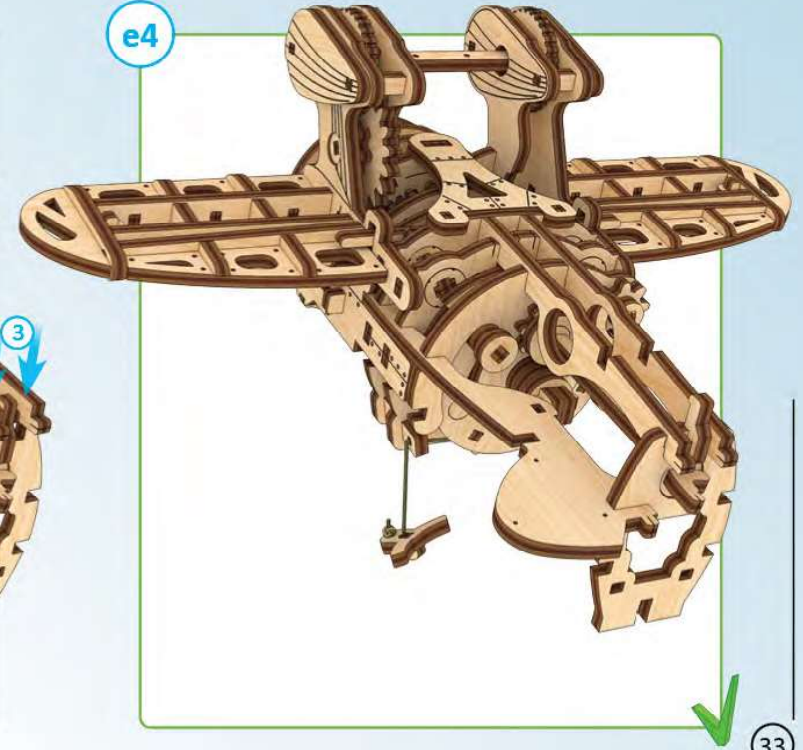

Mechanical models

1

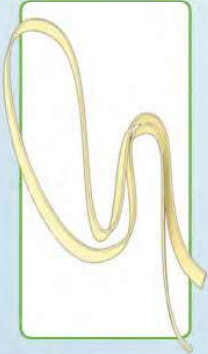

2

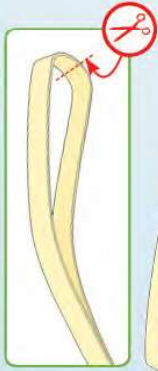

3

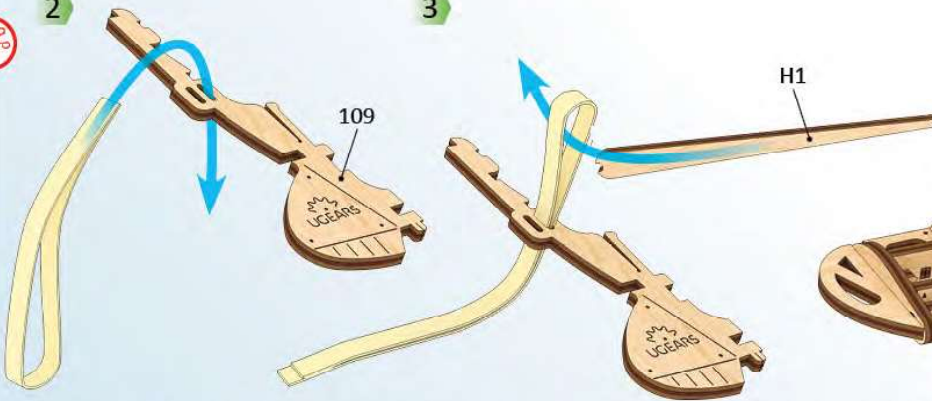

1

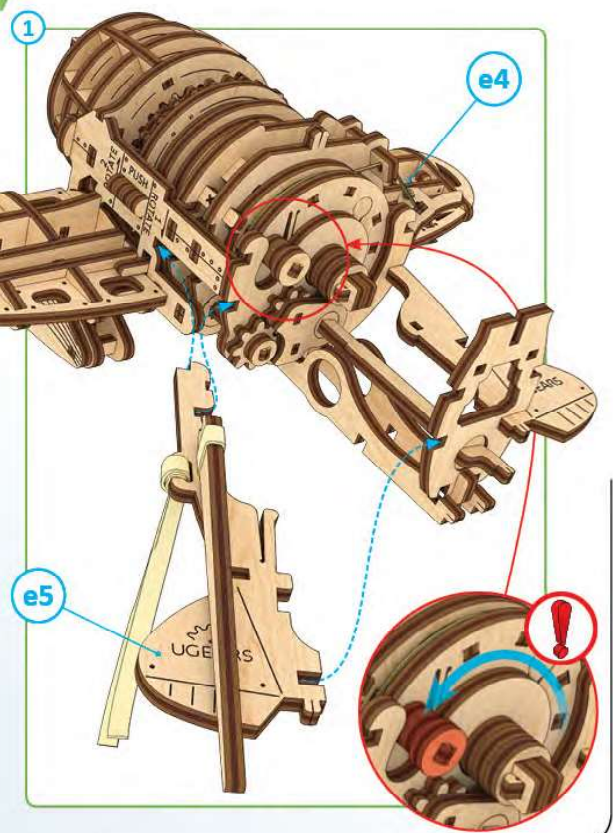

4

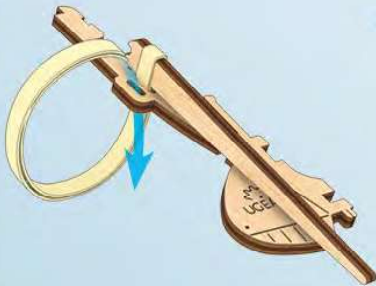

5

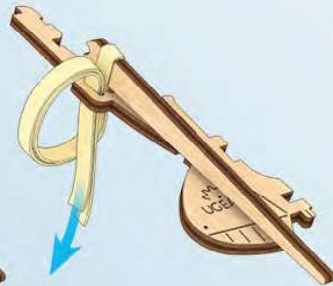

e5

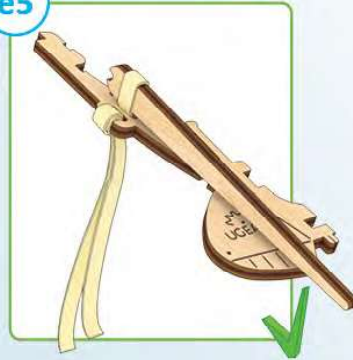

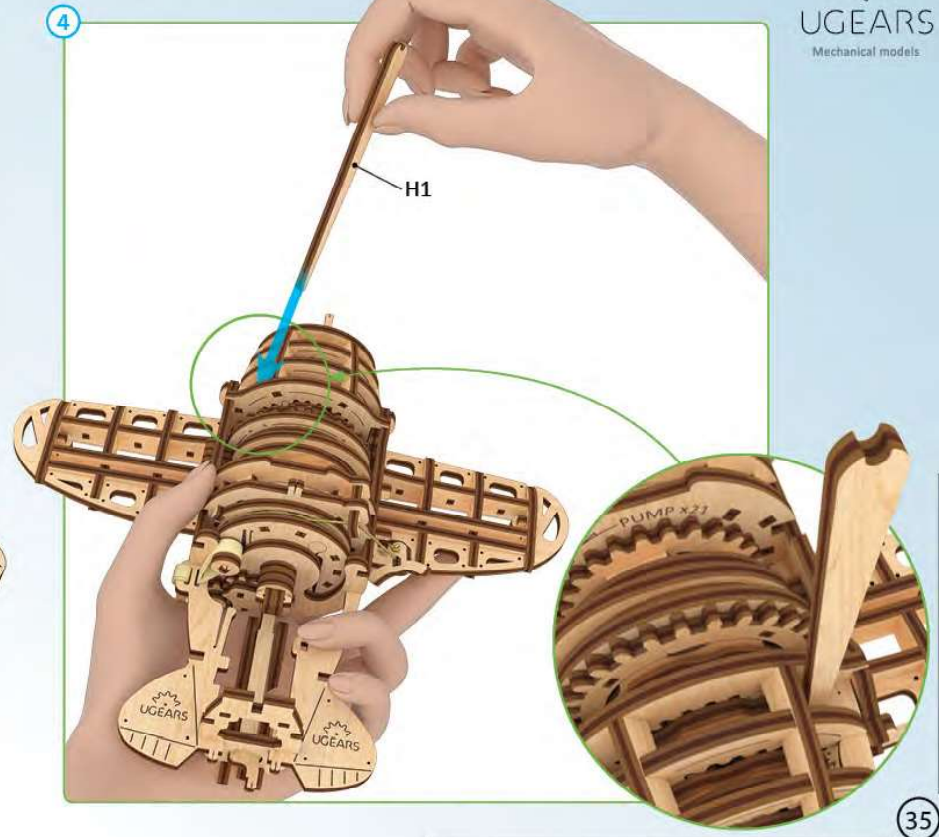
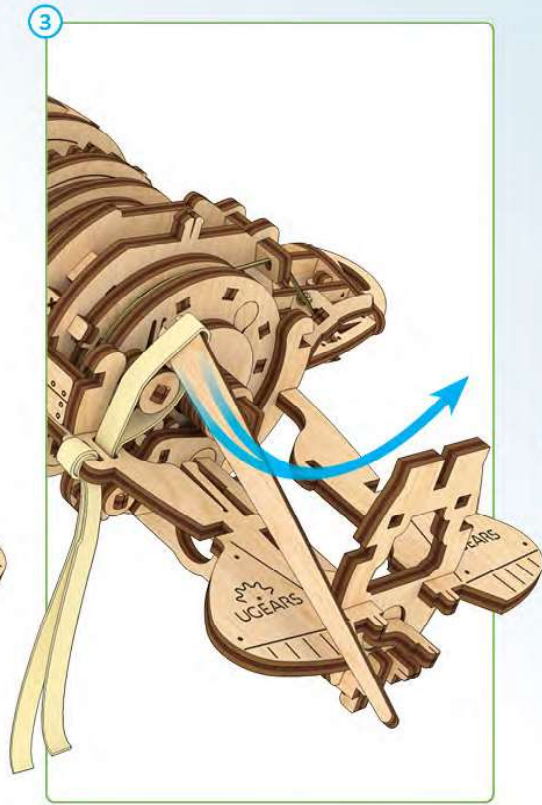
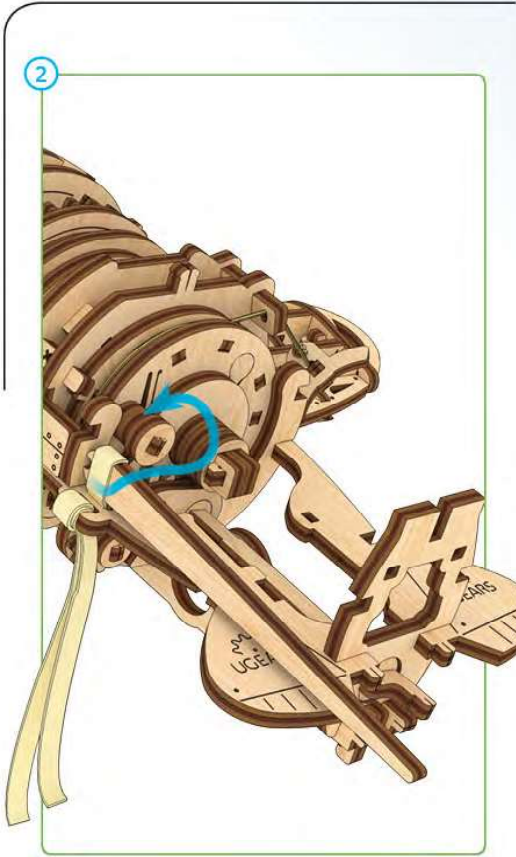

5

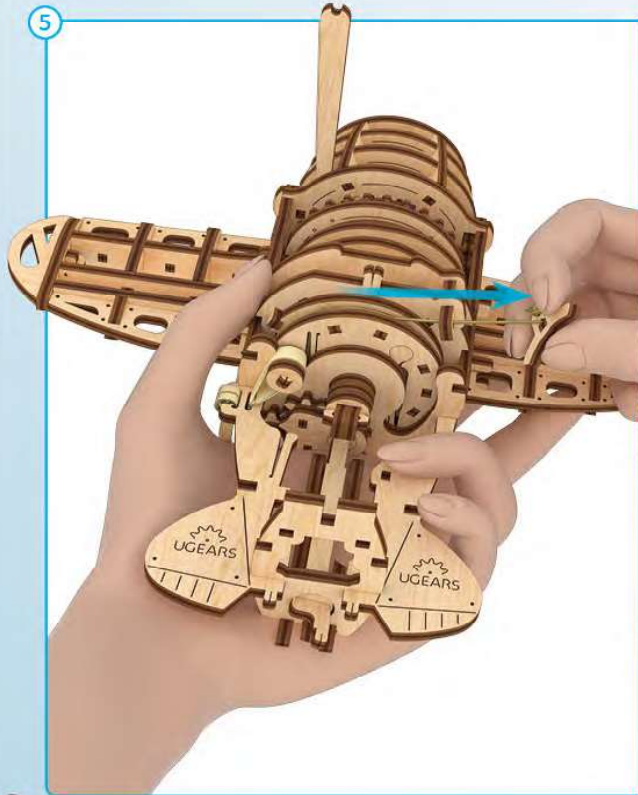

3

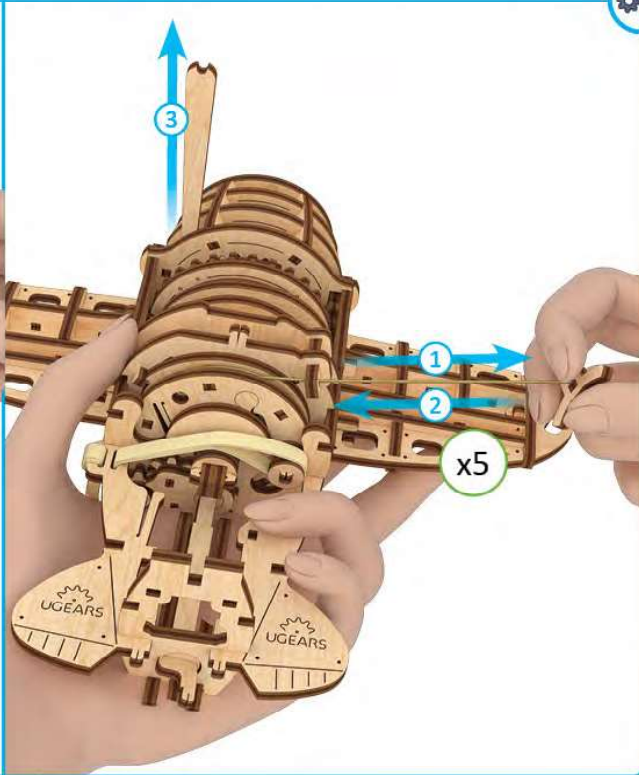

e6

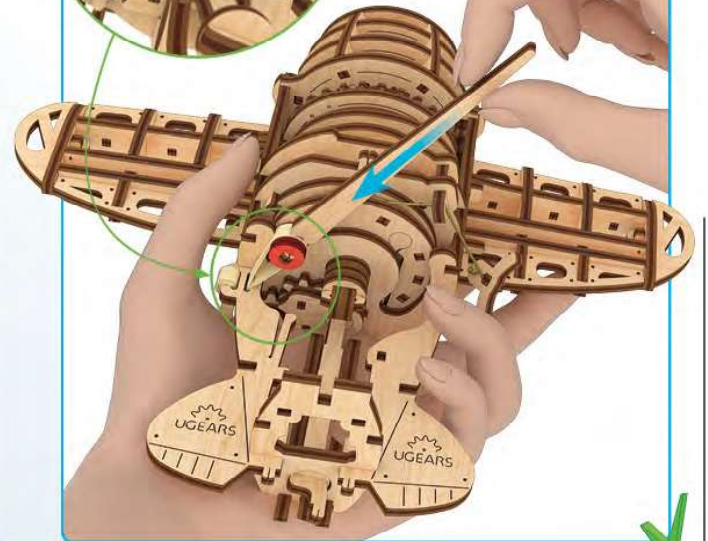
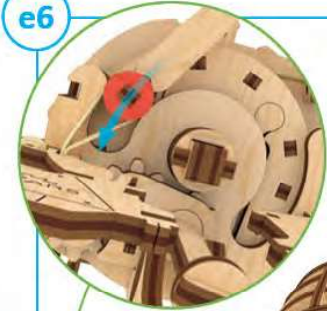

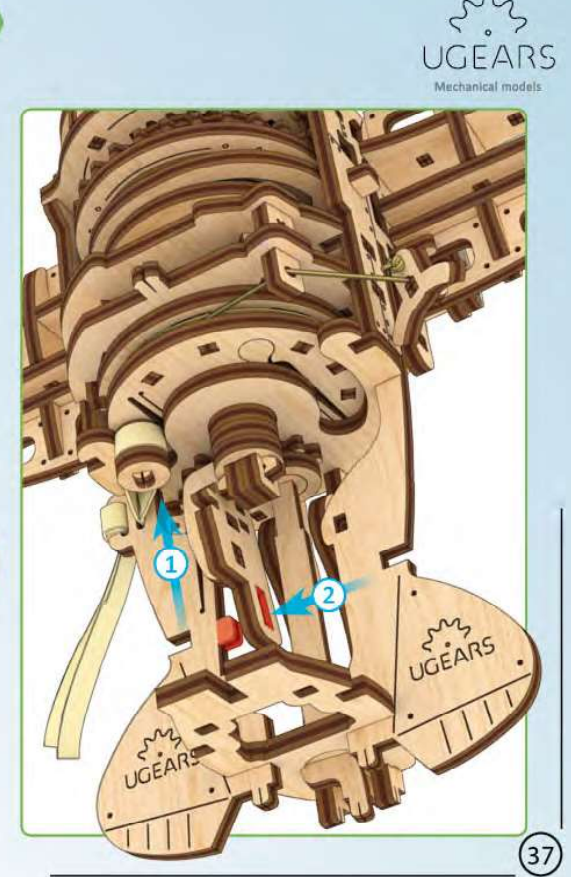
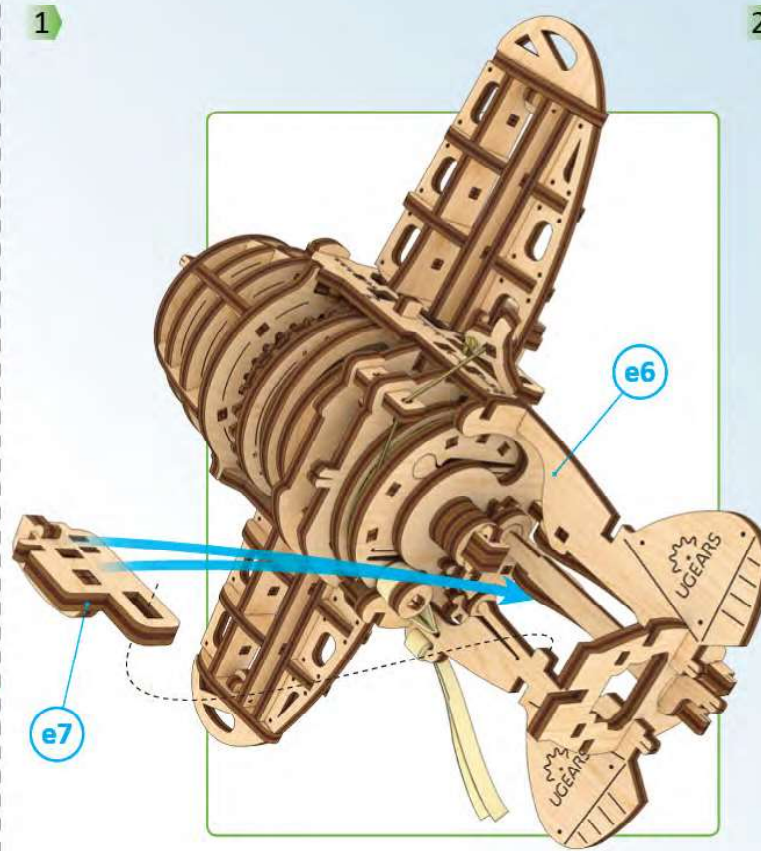
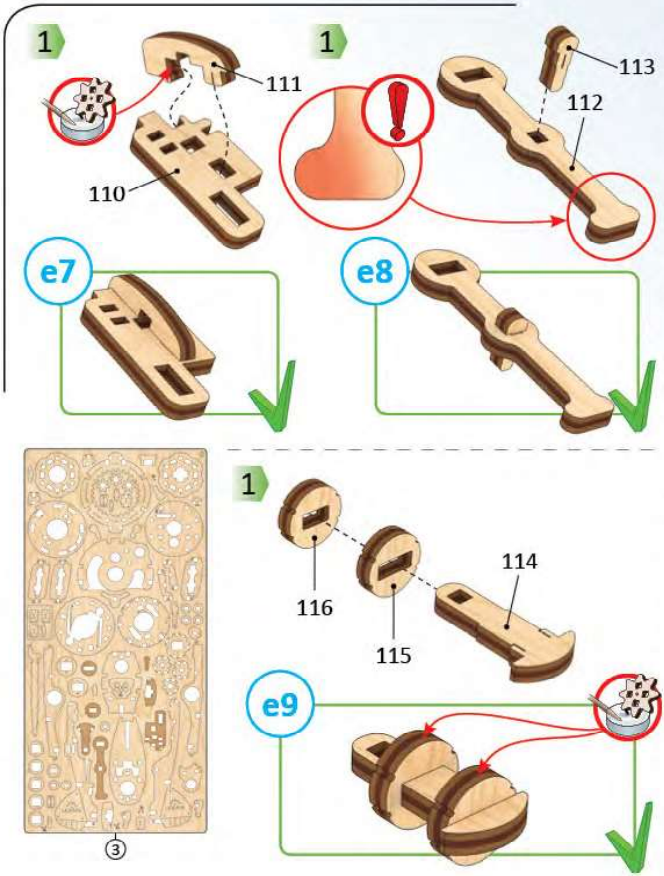

3

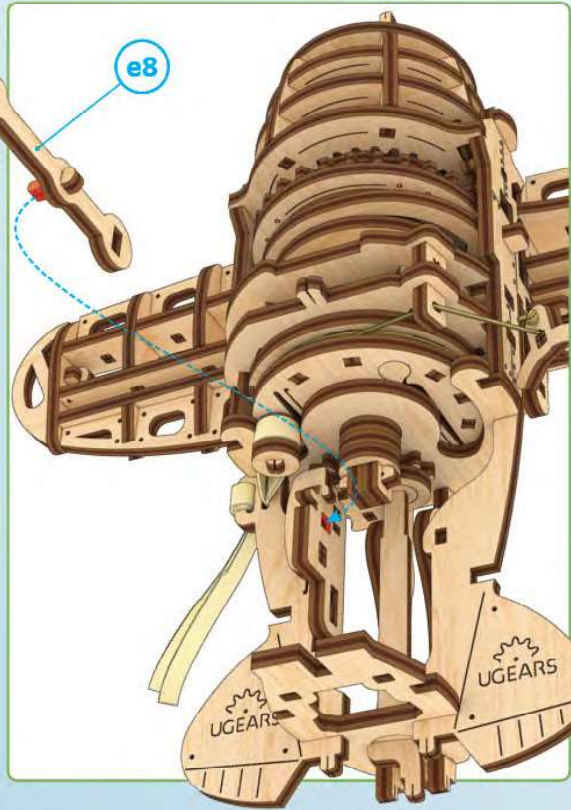

4

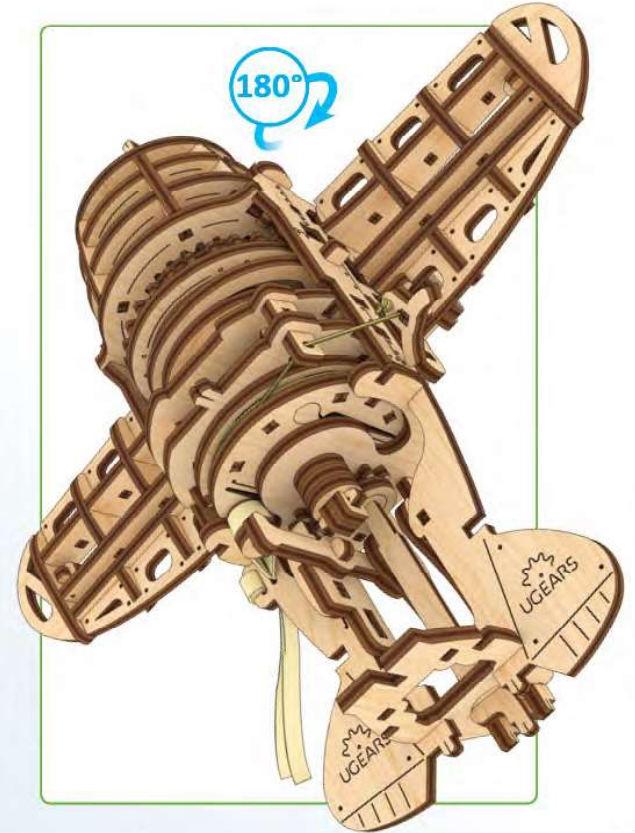
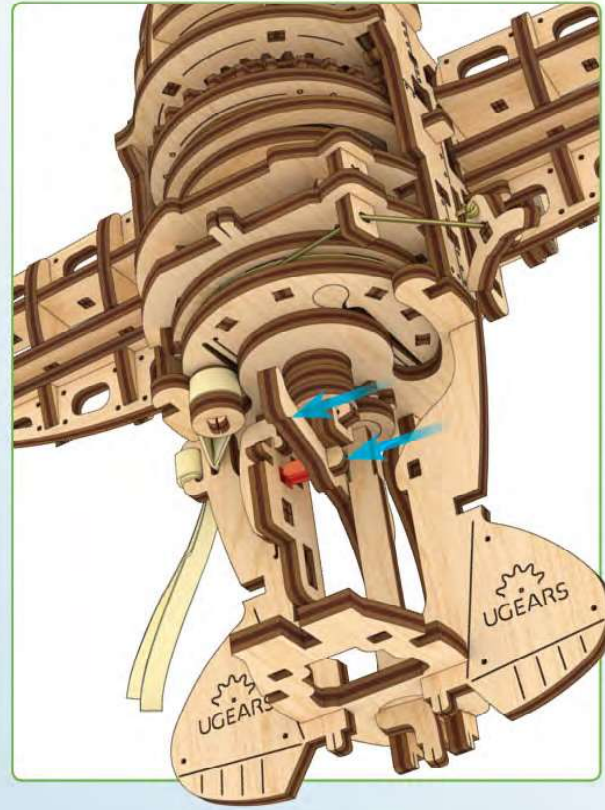

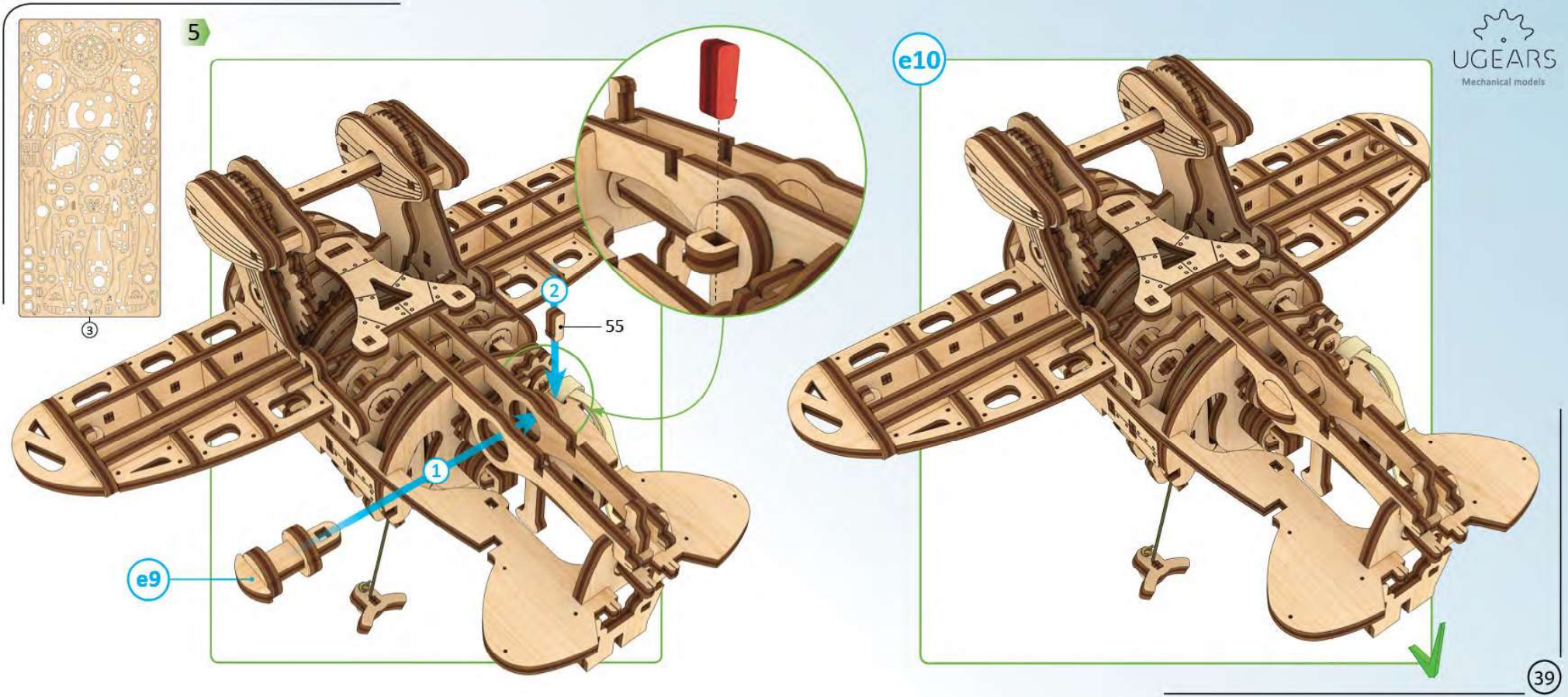

Mechanical models

1

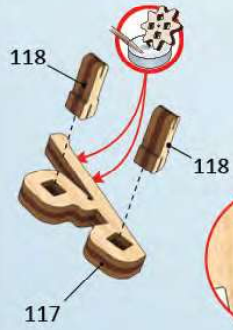

2

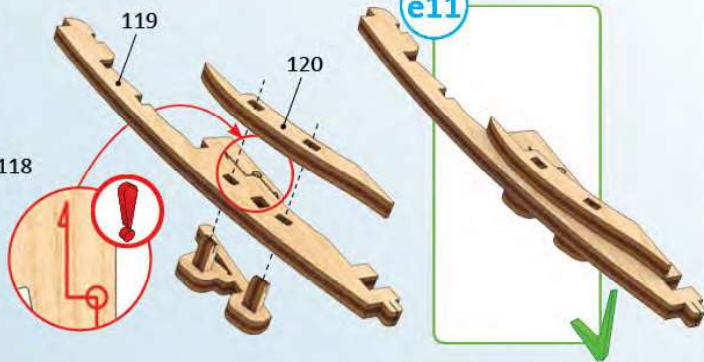

1

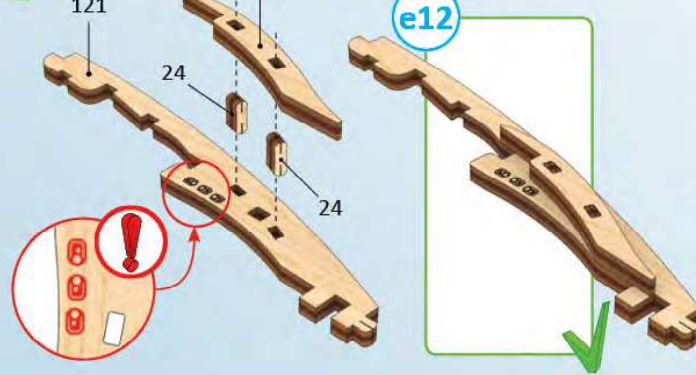

1

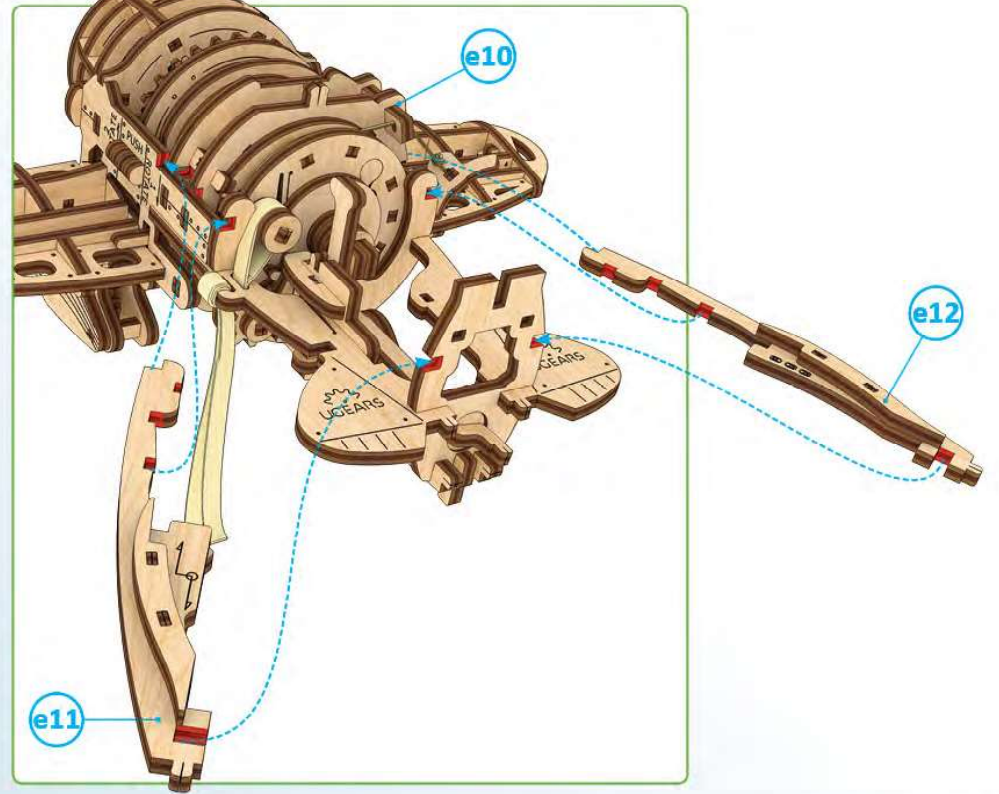



2

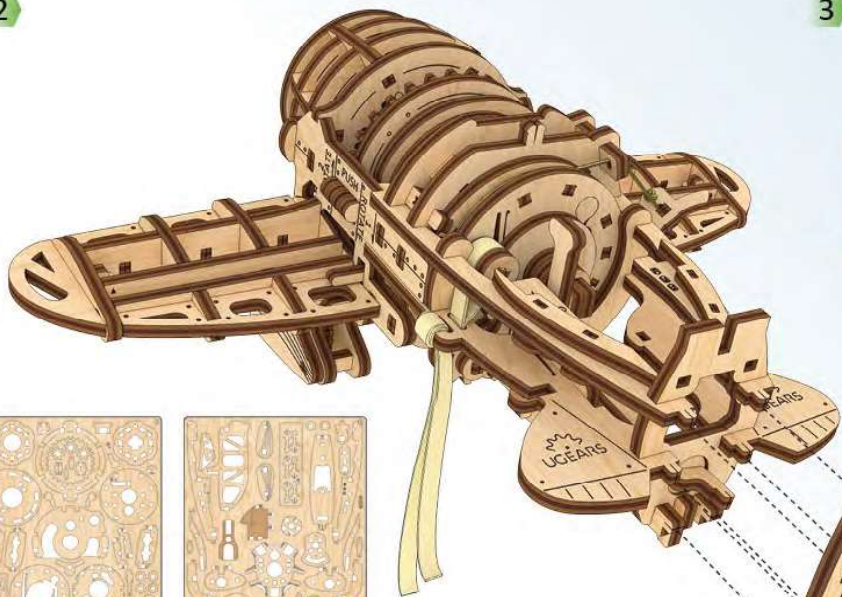

3

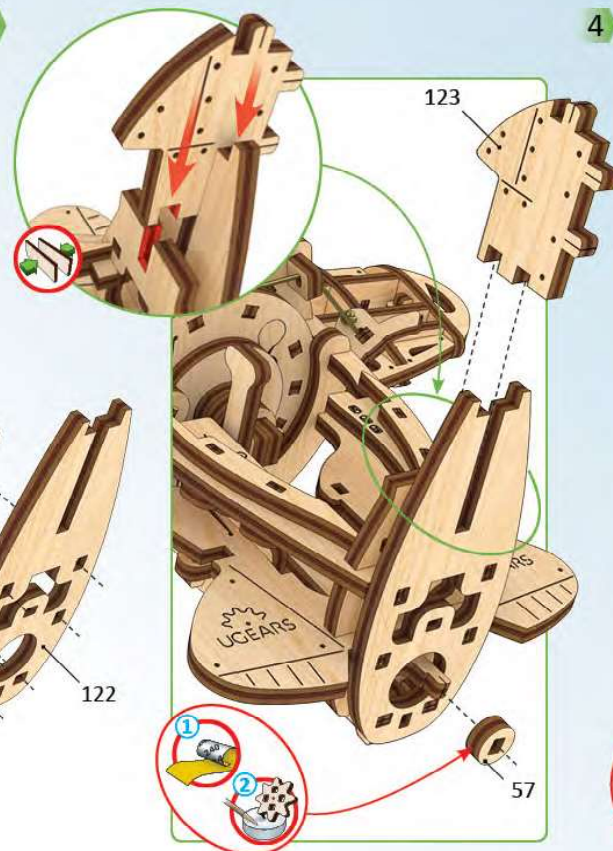

4

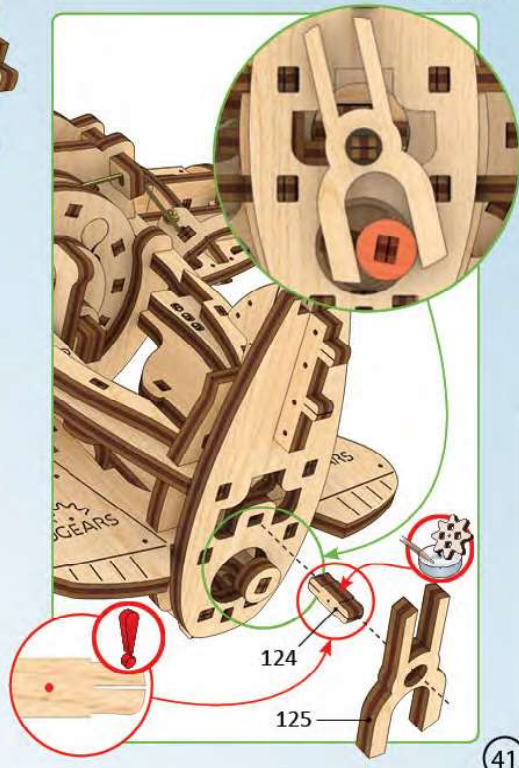

3



4

5

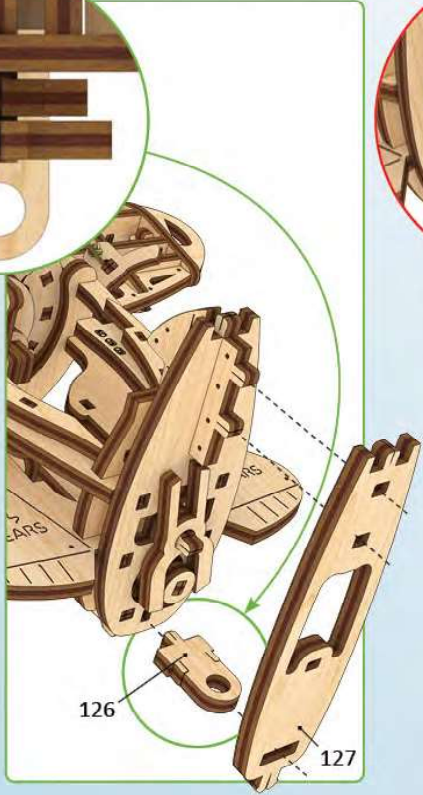

126

127

6

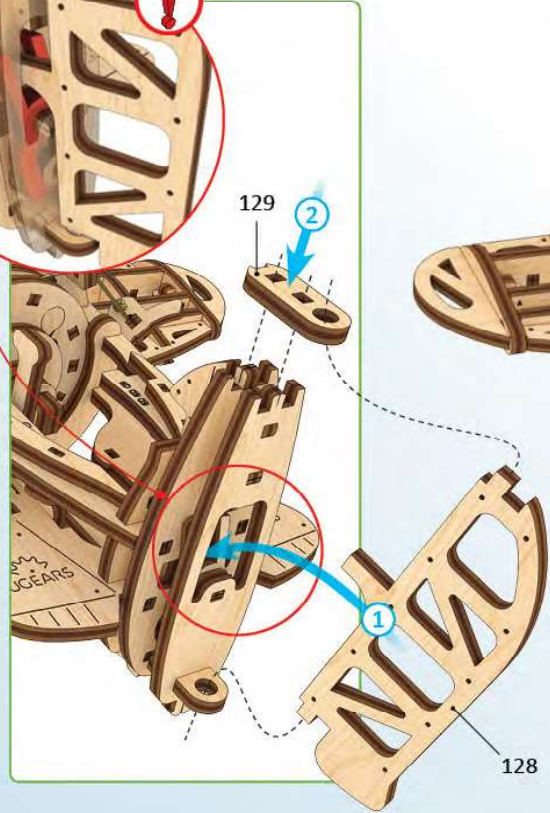
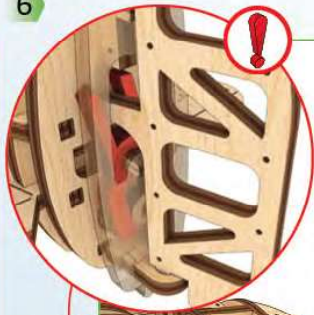

129

128

e13

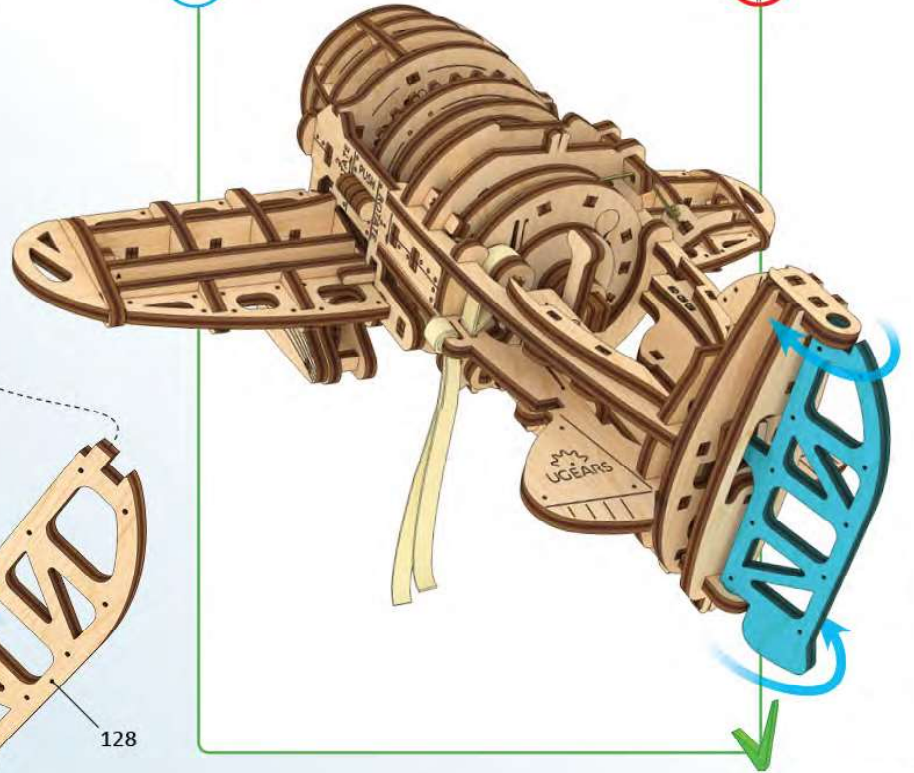

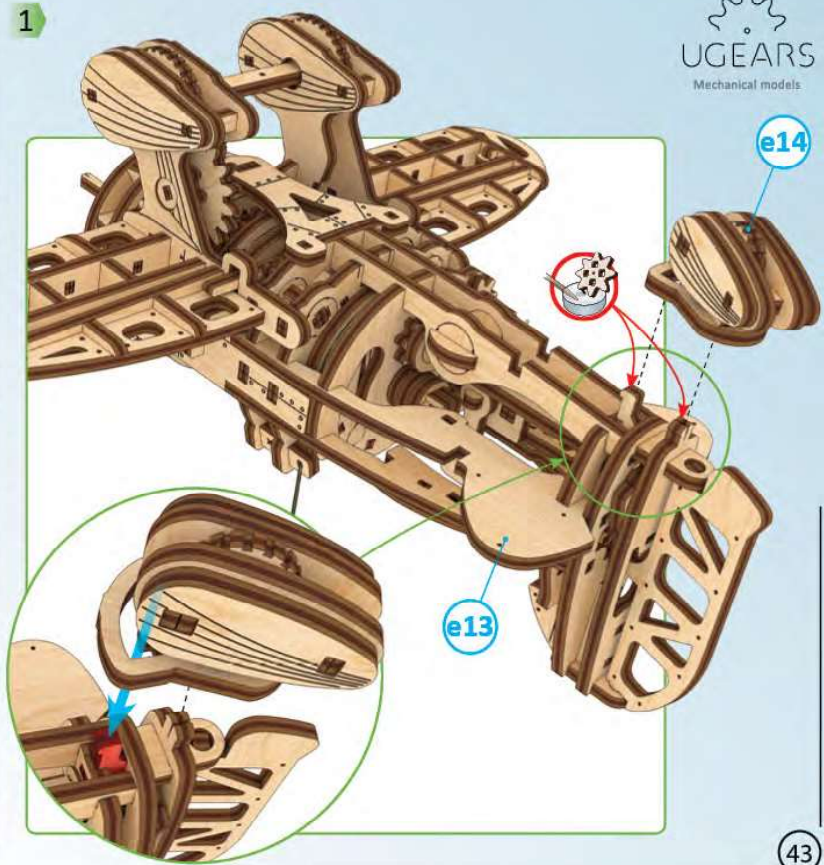
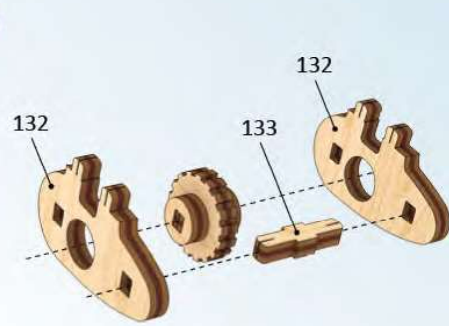
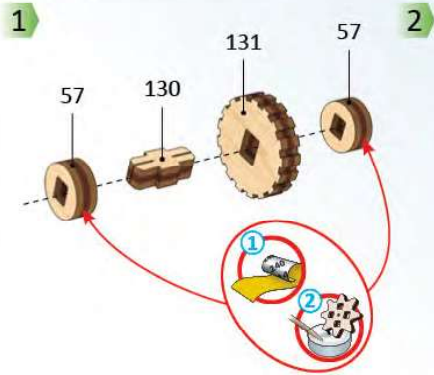
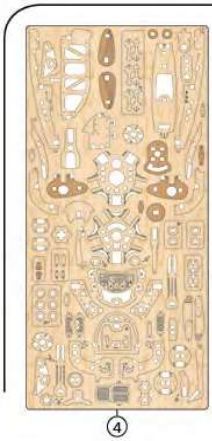

2

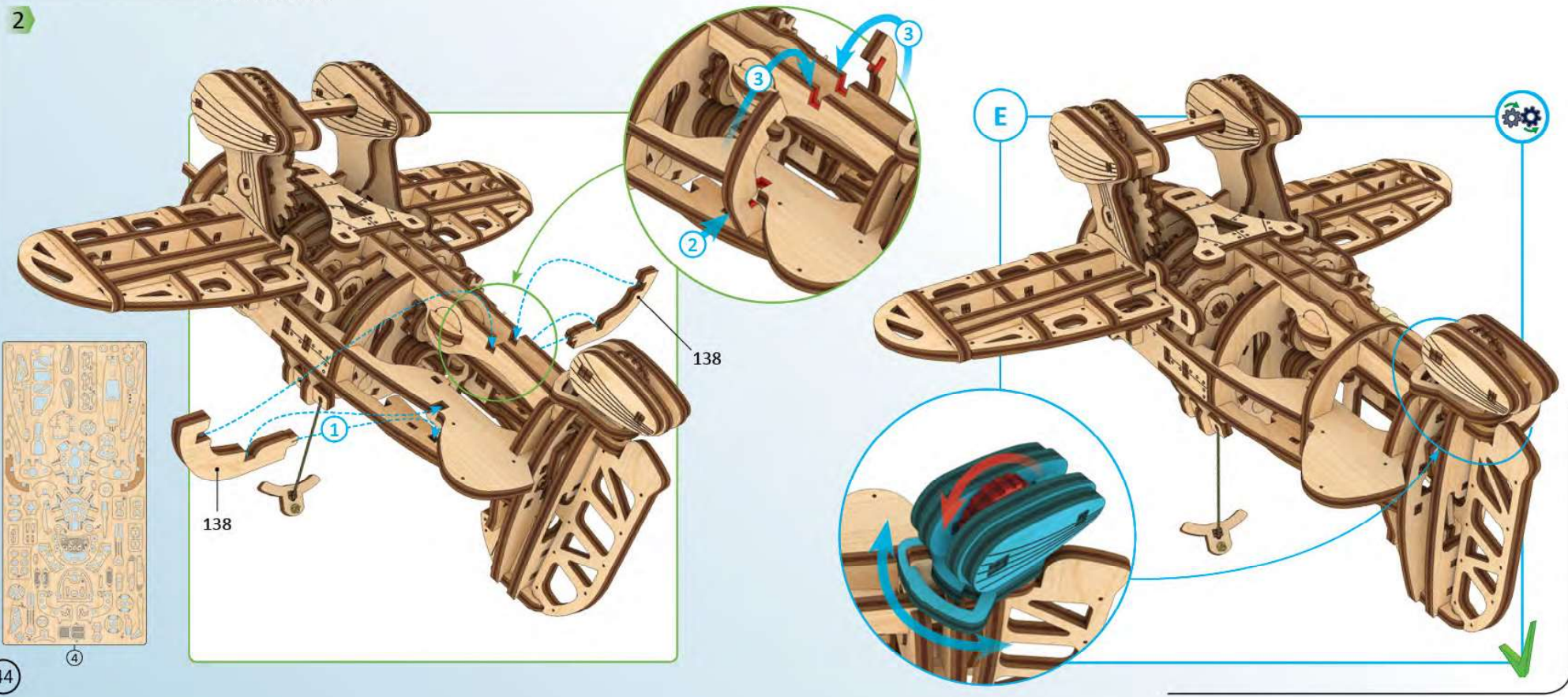

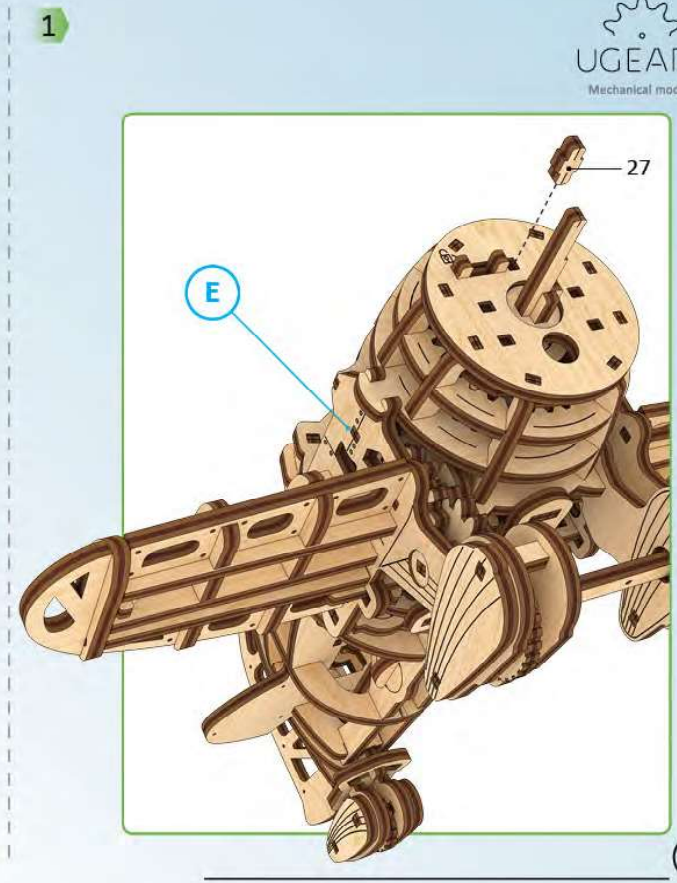
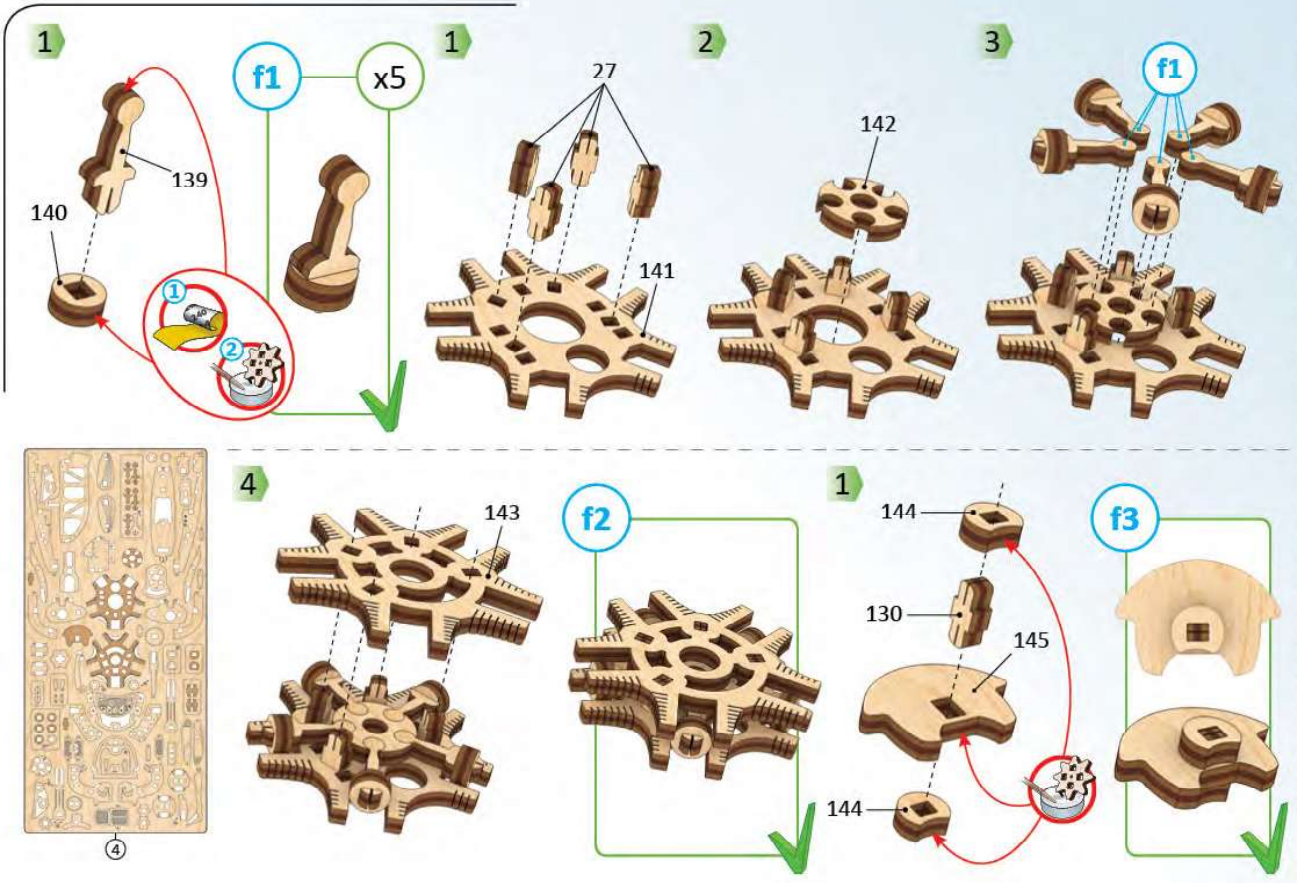

Mechanical models



2

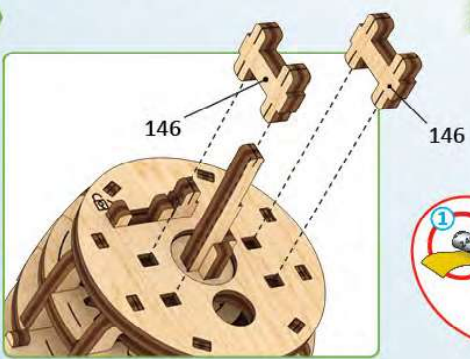

3

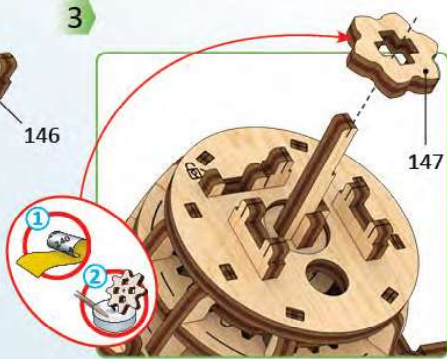

4

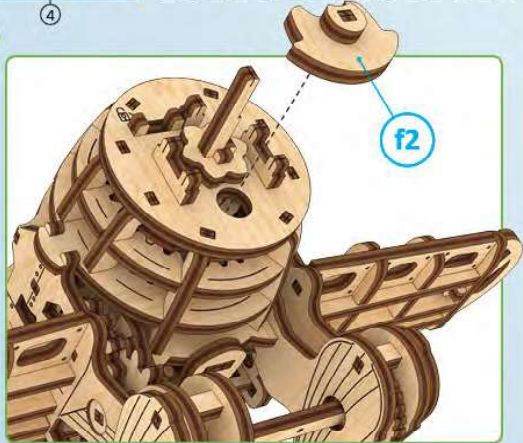

5

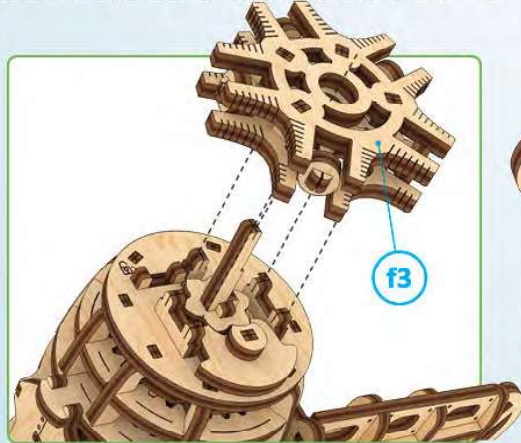

f4

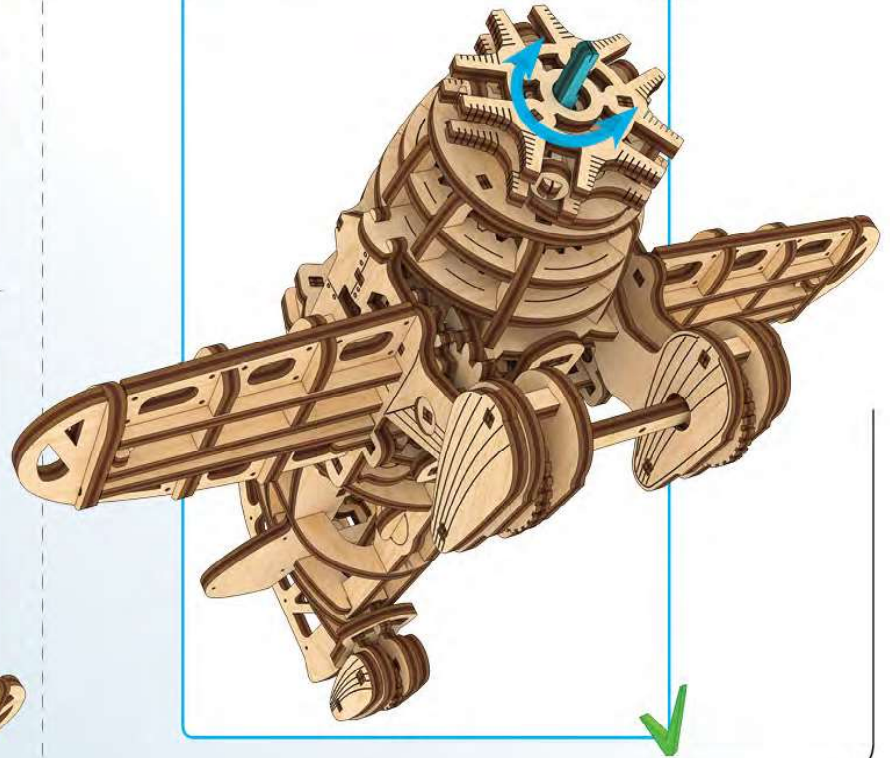

1

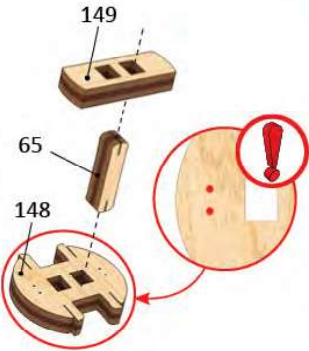

2

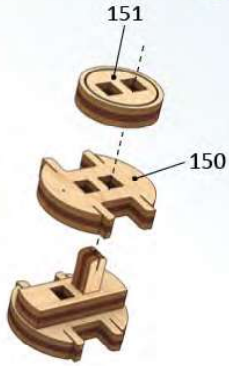

3

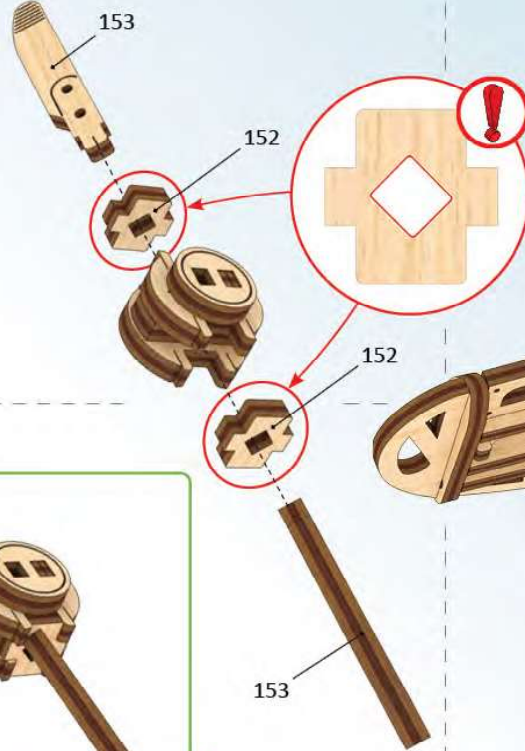

f5



f6

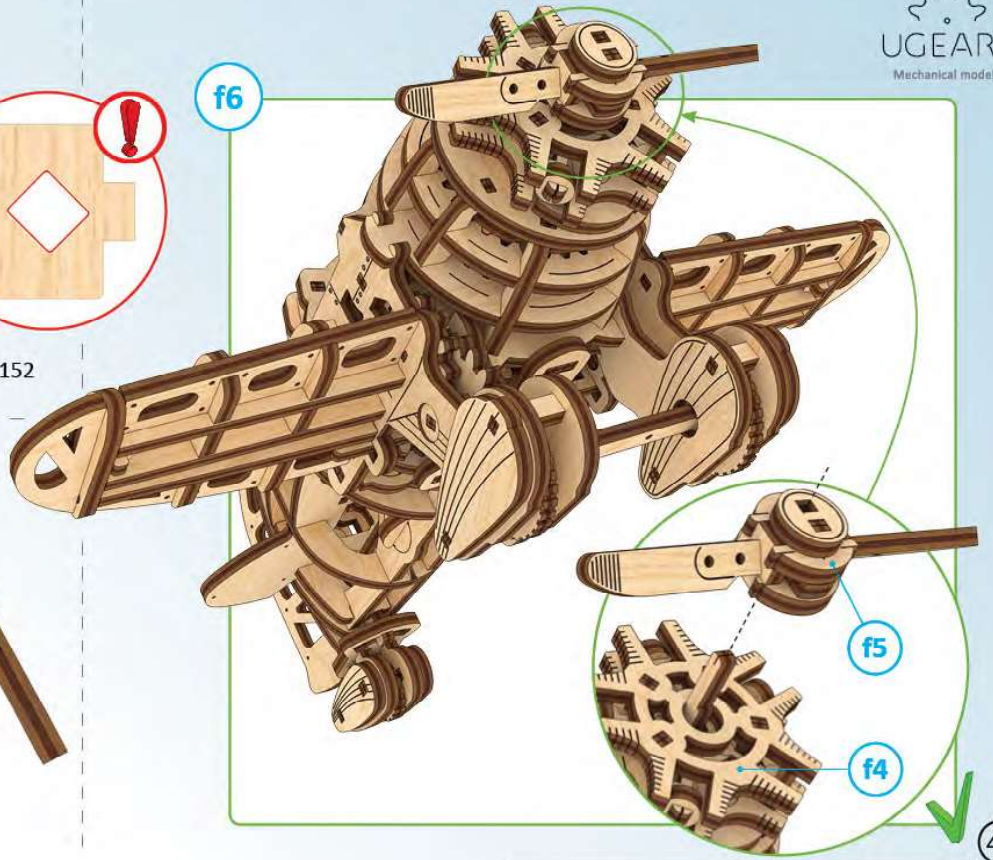

f5

f4

47

Mechanical models



4

1

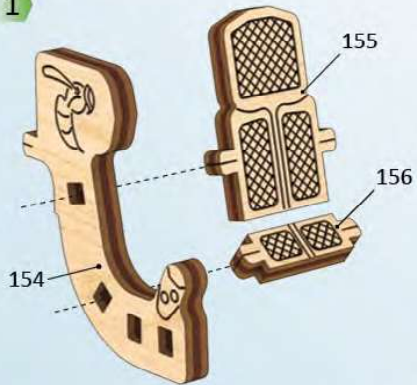

2

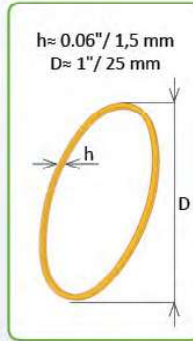

3

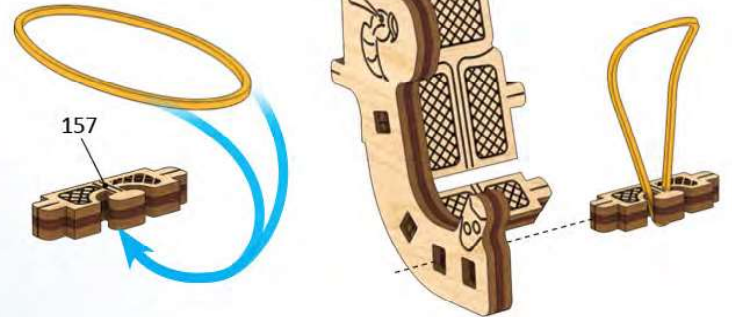

4

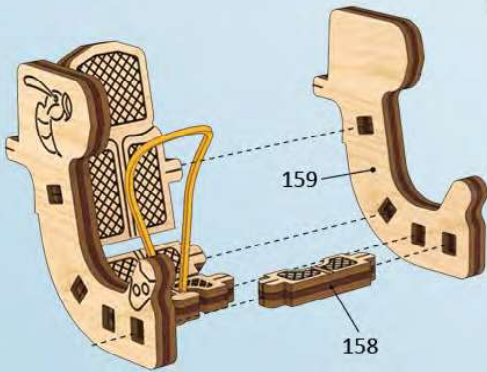

5



6

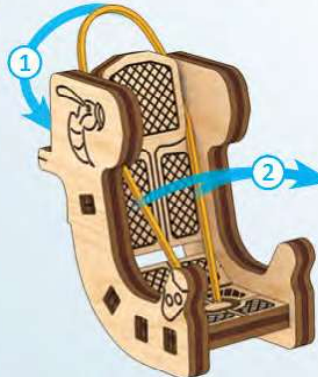

f7

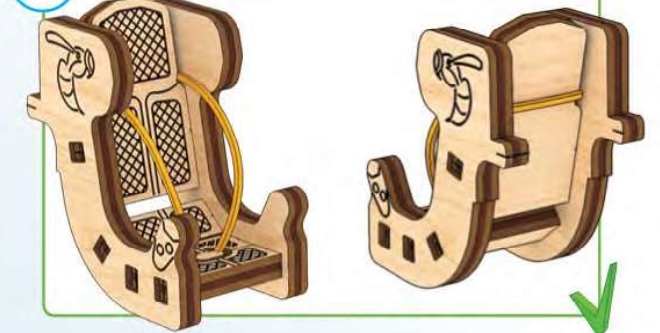



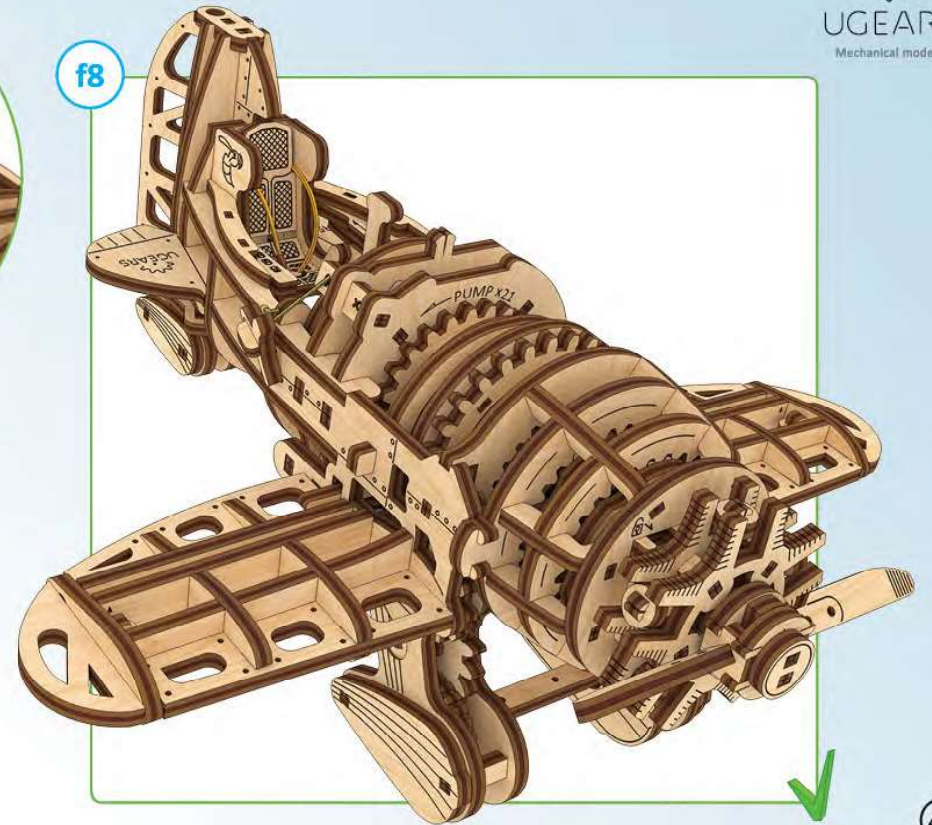
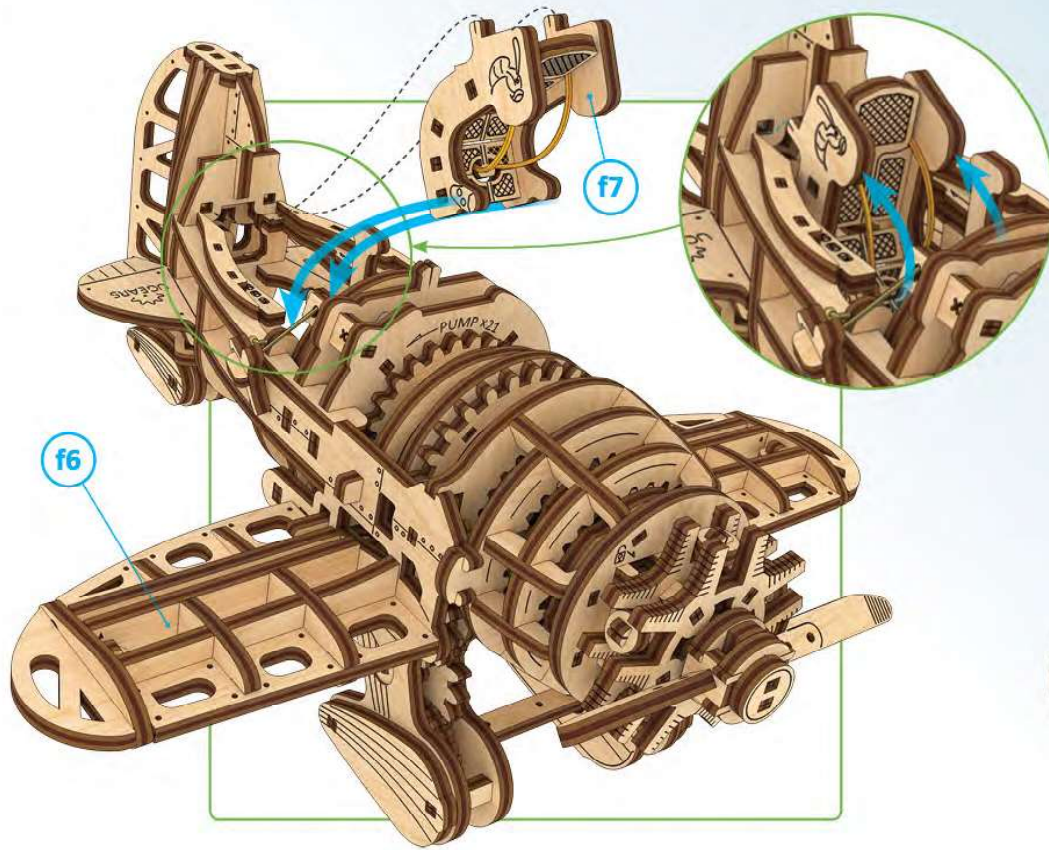

Mechanical models

1

2

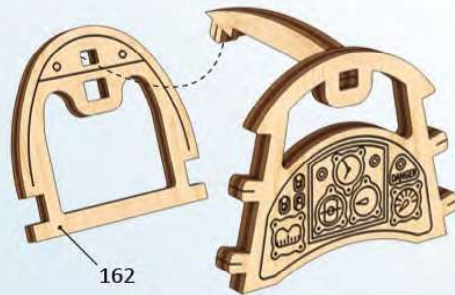
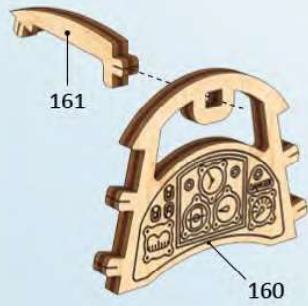

3

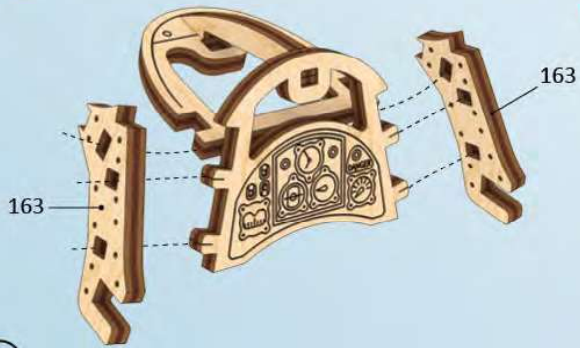

f9

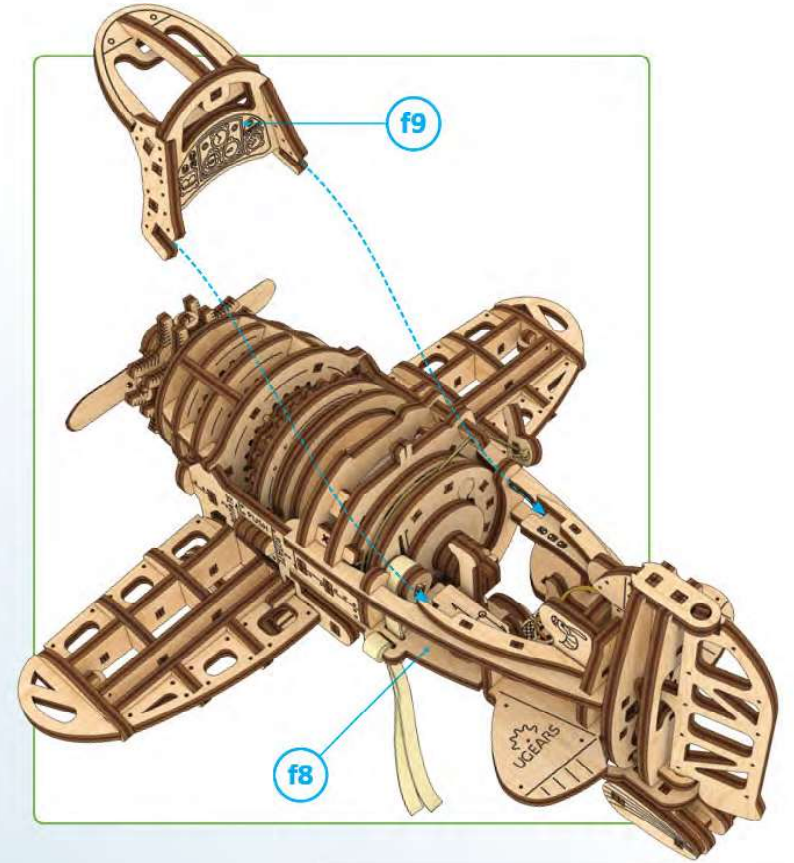

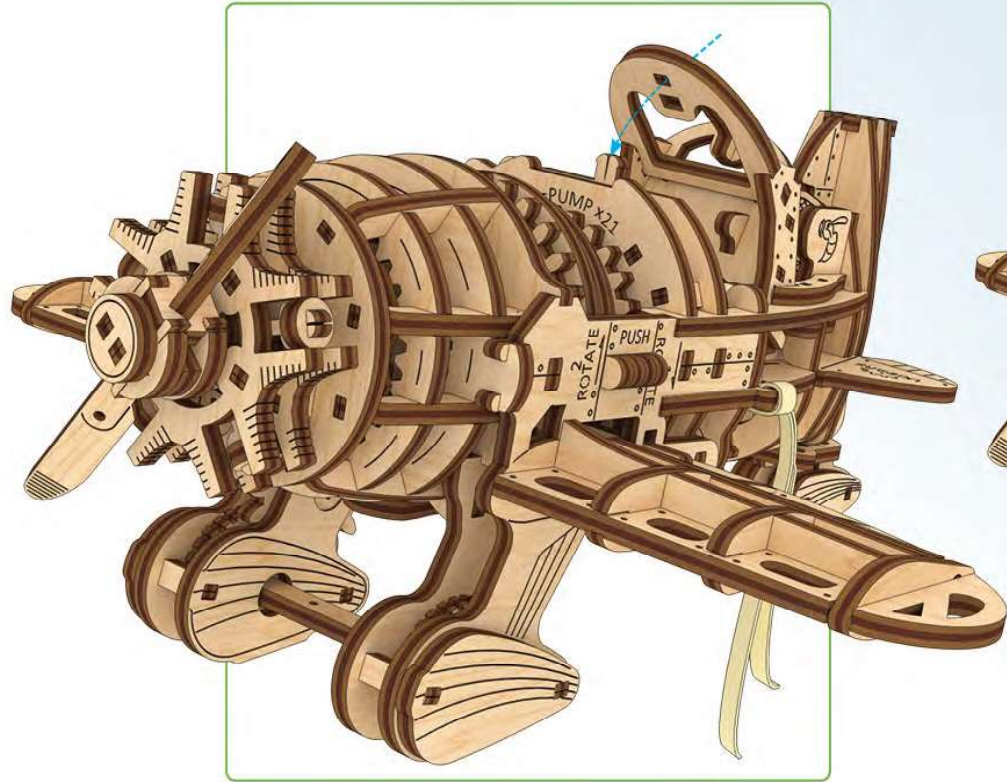

f10

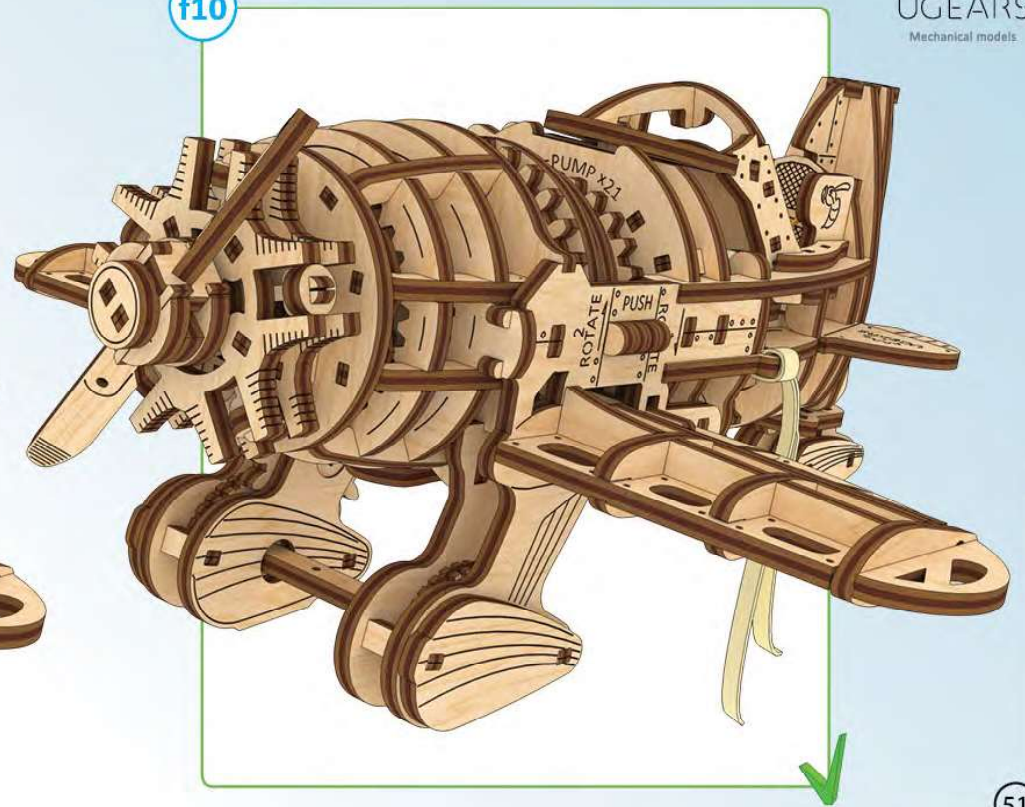

Mechanical models

1

Nylon thread

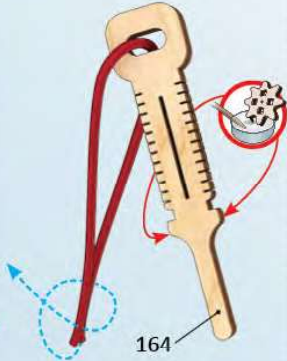
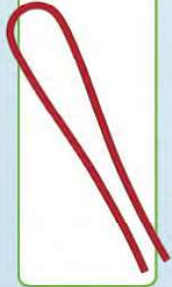

1

1

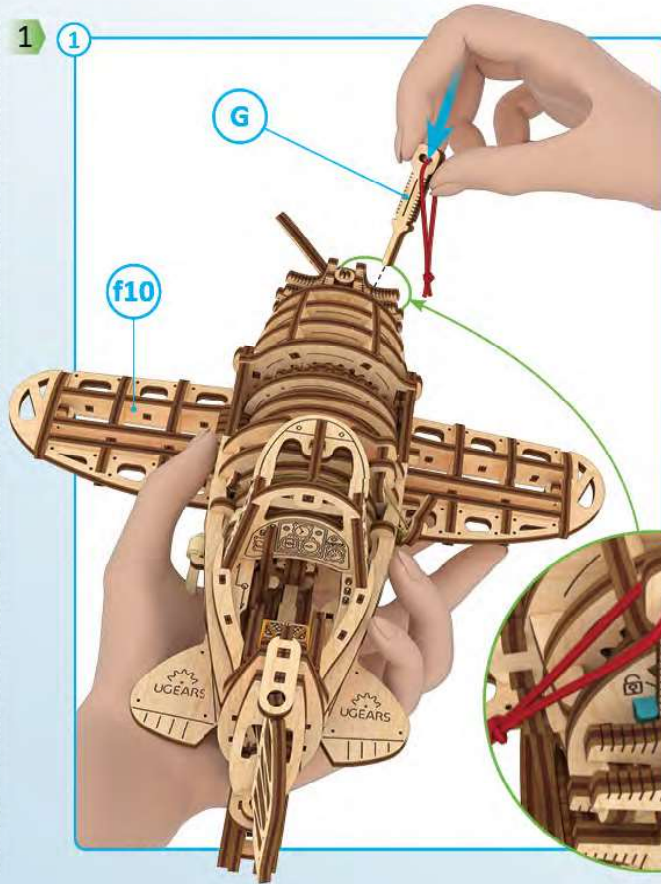

2

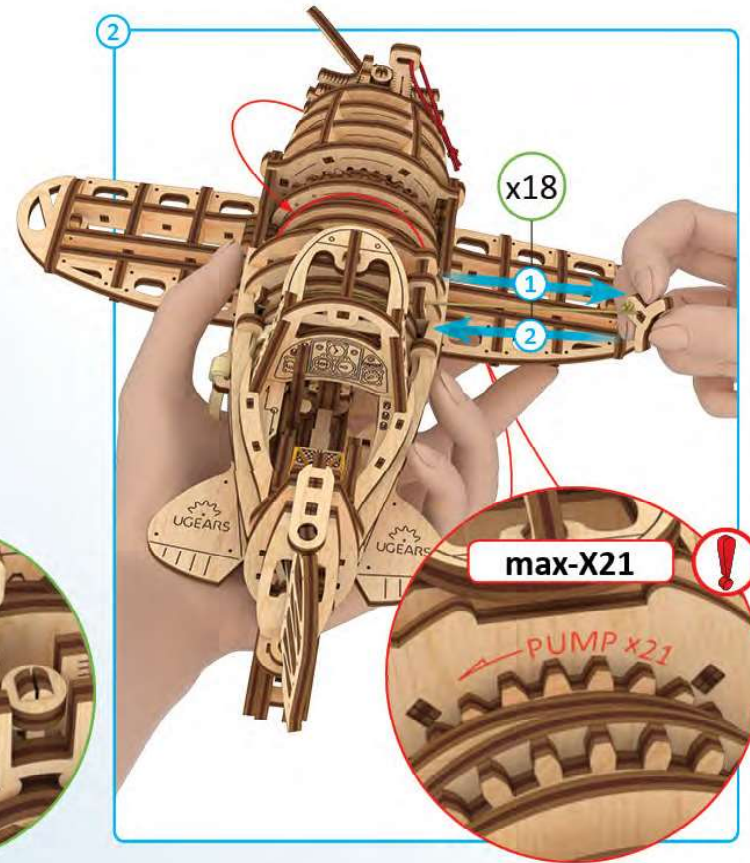

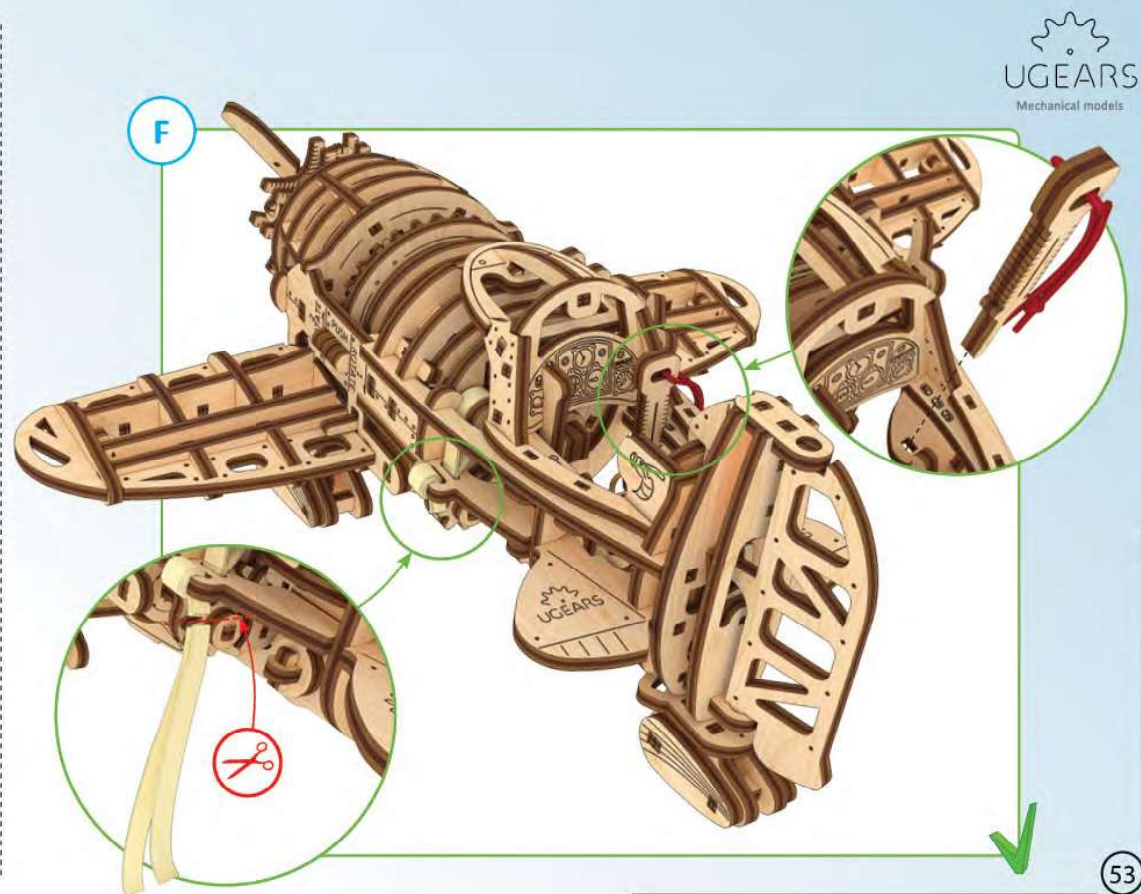
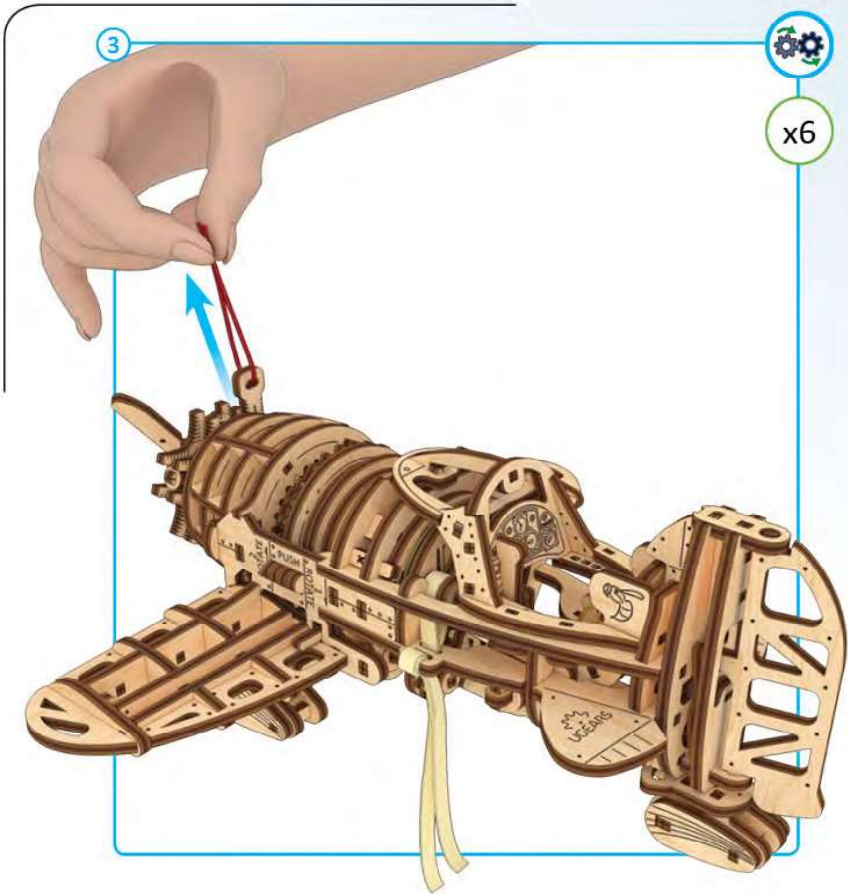

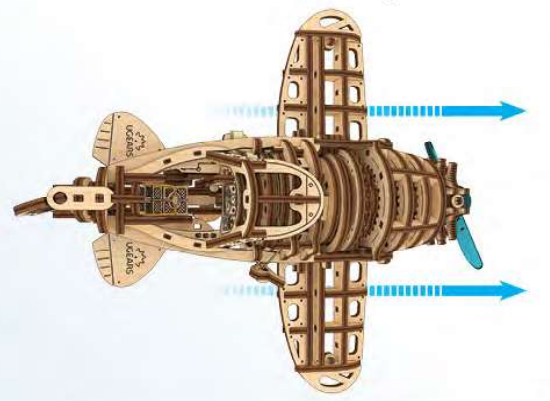
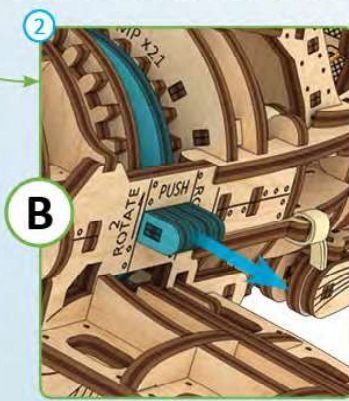
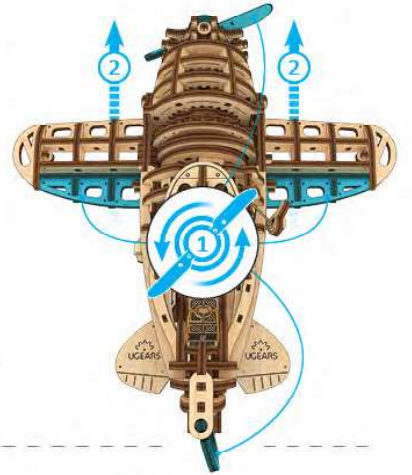
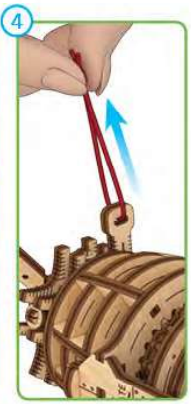
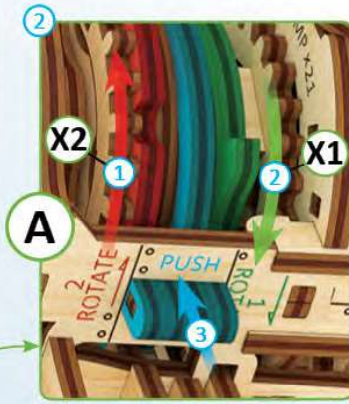
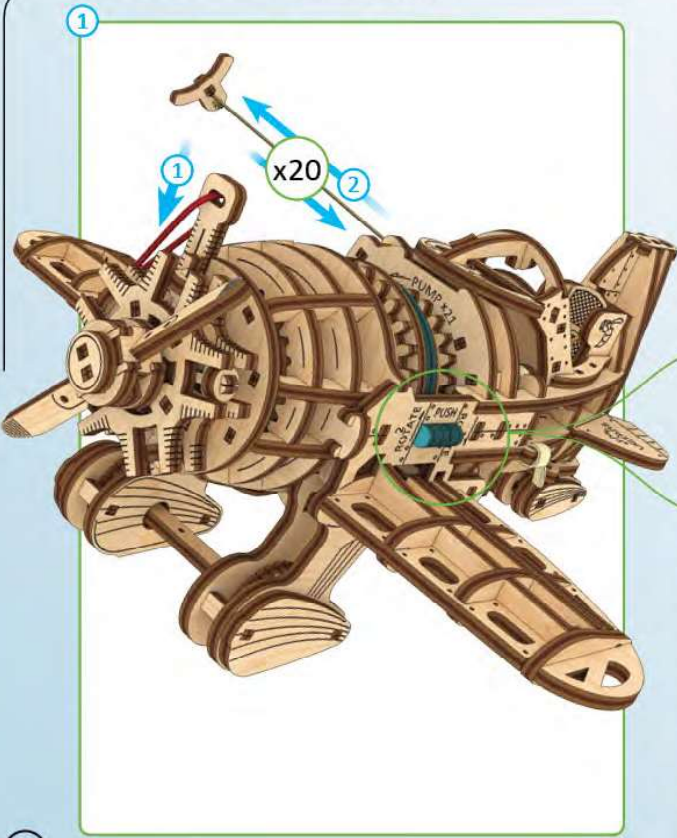

ENG Replacing the rubber-bands. UKR Заміна гумок. FRA Remplacement des élastiques. DEU Austausch des Gummibands. SPA ESustitución de las gomas elásticas. ITA Sostituzione delle fasce in gomma. JAP ゴムバンドの交換。  
 CHI 更換橡皮筋 POR Substituir as fitas de borracha. POL Jak wymienić gumkę. KOR 탄성 밴드 교체 방법

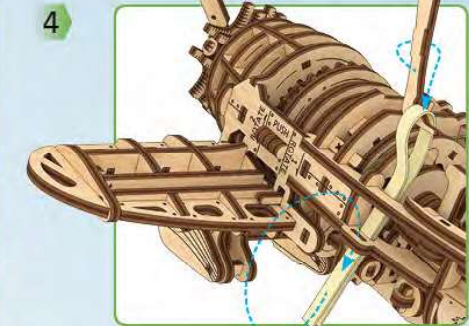
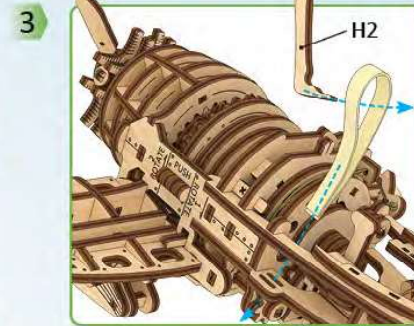
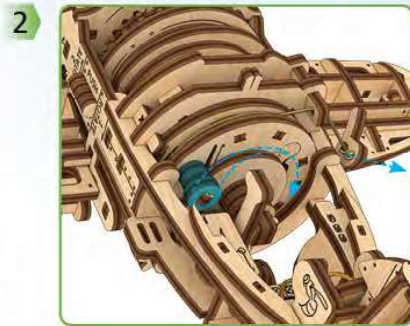
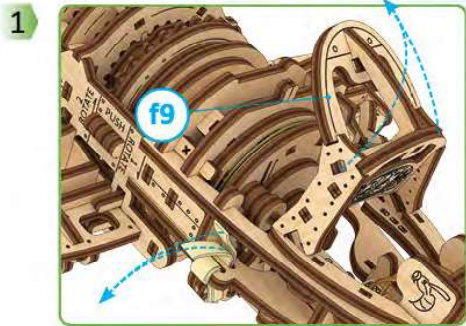

4

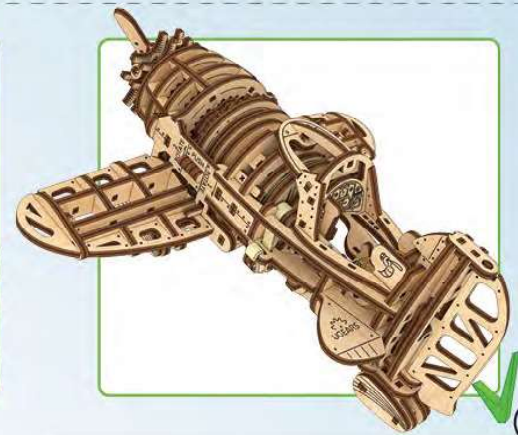
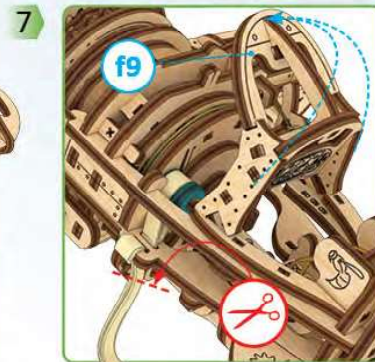
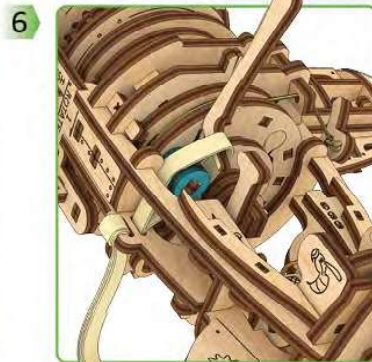
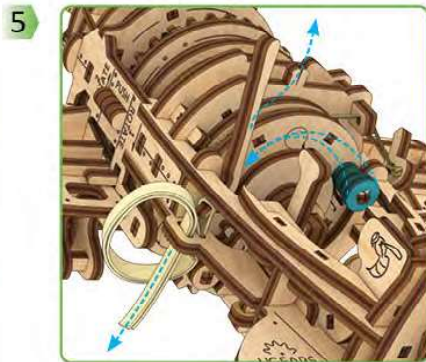

55



**ENG** Thanks for following along on this journey with us.  
**UKR** Дякуємо, що ви пройшли цей шлях з нами.  
**FRA** Merci denous avoir accompagnés tout au long de ces étapes.  
**DEU** Vielen Dank, dass Sie diesen Weg mit uns gegangen sind.  
**SPA** Gracias por haber recorrido el camino con nosotros.  
**ITA** Grazie per aver fatto uesto percorso con noi.  
**JPN** UGEARSをご利用いただきありがとうございます  
**CHI** 感谢您参与有趣的模型拼装过程。  
**POR** Obrigado por seguir nesta jornada conosco.  
**POL** Dziękujemy, że razem z nami pokonałeś tę drogę!  
**KOR** UGEARS 와 함께해 주셔서 감사합니다.

[ugearsmodels.com](http://ugearsmodels.com)

**ENG** Customer support **UKR** Служба підтримки  
**FRA** Service client **DEU** Kundendienst  
**SPA** Servicio al cliente **ITA** Servizio di supporto  
**JPN** お客様窓口 **CHI** 客户支持 **POR** Atendimento ao cliente **POL** Wsparcie klienta **KOR** 고객센터  
[customerservice@ugearsmodels.com](mailto:customerservice@ugearsmodels.com)