

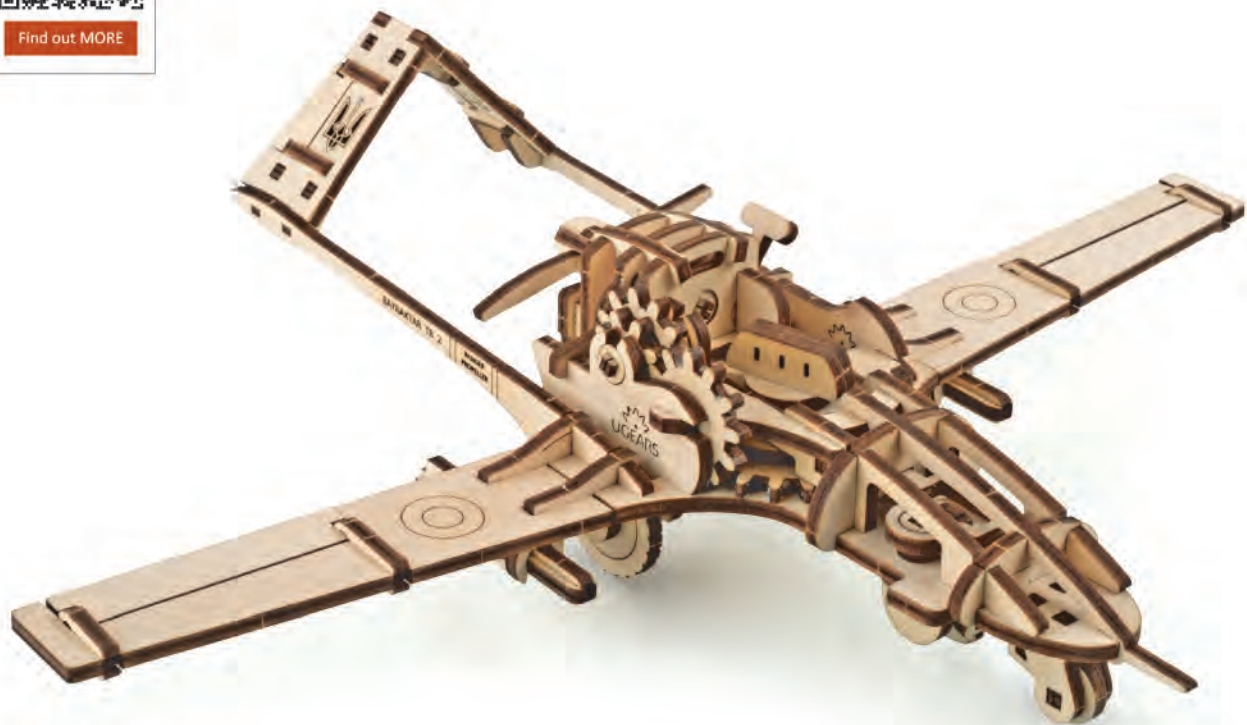

Assemble Me.  
Defeat the invaders with me!

Find out MORE



  
UGEAR'S®  
Mechanical models

## Bayraktar TB2 combat drone Байрактар ТБ2

FRA Drone de combat Bayraktar TB2 DEU Kampfdrohne Bayraktar TB2  
SPA Dron de combate Bayraktar TB2 ITA Drone da combattimento Bayraktar TB2  
JPN コンバットドローンバイラクトルTB2 CHI Bayraktar TB2战斗无人机  
TUR Bayraktar TB2 SIHA POL Dron bojowy Bayraktar TB2  
KOR 바이라ктар TB2 전투드론

### Assembly instructions Інструкція зі складання

FRA Notice d'assemblage. DEU Aufbauanleitung.  
SPA Instrucciones de montaje. ITA Istruzioni di montaggio.  
JPN 組み立て説明書 CHI 装配说明书 TUR Birleştirme talimatları.  
POL Instrukcja montażu. KOR 조립 설명서.



MECHANICAL  
МЕХАНІЧНИ



NO GLUE CONNECTION  
БЕЗ КЛЕЮ



PLYWOOD  
З ФАНЕРИ

## ENG

**Assembly instructions:**  
Remove model parts from the hanger board as illustrated below. Careful not to break parts. If a part does not remove easily, carefully cut it out with a knife. This model is intended for self-assembly without glue. If you have difficulty installing the axles, try waxing them with a regular candle. All moving parts can also be waxed during assembly to reduce friction when operating the model.

## CHI

**装配说明**  
将模型部件按插图示，从胶合板取下。小心不要损坏件。如果取下时候有难度，请用小刀小心的切割连接点。这个产品不需要胶水粘接。如果安装转轴的时候有难度，请用普通的蜡加以润滑。所有的转动部分也需要打蜡润滑。

## UKR

**Інструкція зі складання:**  
Витягніть з дошки позначені на схемі деталі. Намагайтеся їх не зламати. Якщо деталь не виймається, надсічіть перемички ножом. Конструкція збирається без клею. У разі виникнення труднощів з протягуванням вісі в отвір, потріть деталь об звичайну свічку. Також можна змастити свічку всі деталі механізму, що рухаються, щоб зменшити тертя при обертанні.

## TUR

**Birleştirme talimatları:**  
Model parçaları, askı tahtasından aşağıda gösterildiği şekilde çıkartın. Şayet herhangi bir parça kolaylıkla çıkmazsa, bıçak yardımıyla dikkatlice kesiniz. Bu model, yapıştırıcı kullanılmadan birleştirilmesi üzerine tasarlanmıştır. Aksları takmakta zorluk çekiyorsanız, normal bir mumla cilalamayı deneyebilirsiniz. Modeli çalıştırırken sürtünmeyi azaltmak adına birleştirme esnasında tüm hareketli parçaları cilalayabilirsiniz.

## FRA

**Notice d'assemblage:**  
Faites sortir de la planche les pièces comme indiquées sur le schéma. Tâchez de ne pas les casser. Si la pièce ne sort pas, incisez les collages/fixations avec un couteau. La construction est à assembler sans colle. Si il est difficile d'introduire l'axe en bois dans l'orifice, frottez au préalable l'axe ou les pièces contre une bougie. Pour améliorer le glissement, traitez les pièces de frottement mobiles du mécanisme avec une bougie au cours d'assemblage.

## POL

**Instrukcja montażu:**  
Delikatnie wyciągaj z deseczki wskazane w schemacie detale, starając się nie połamać elementów. Jeśli detal nie poddaje się, podetnij wiązadła nożem. Konstrukcje składa się bez kleju. Jeśli napotkasz trudności z instalacją drewnianej osi w otwórze, potrzyj na początku oś lub detale o woskową świecę. Dla lepszego poślizgu polecano smarowanie ruchomych części mechanizmu zwykłą świecą podczas montażu.

## DEU

**Aufbauanleitung:**  
Bitte die in der Zeichnung angegebenen Teile aus der Platte herausnehmen. Versuchen Sie bitte diese nicht zu brechen. Wenn sich ein Teil nicht herausnehmen lässt, schneiden Sie die Stege mit dem Messer leicht an. Das Modell wird ohne Klebstoffe zusammengebaut. Lässt sich eine Achse nur schwer in eine Öffnung einführen, reiben Sie diese mit einer Kerze etwas ein. Für besseres Gleiten schmieren Sie alle beweglichen Teile mit einer Kerze.

## KOR

**조립 설명:**  
부품이 손상되지 않도록 주의하여 보드에서 떼어냅니다. 만약 부품이 잘 떨어지지 않으면 연결 부분을 칼로 절단 한 후 떼어내면 쉽게 떼어 낼 수 있습니다. 본 제품은 접착제가 없이 조립이 가능하도록 설계되어 있습니다. 만약 축이 잘 끼워지지 않는 경우 양초를 축에 바른 후 끼워 보세요. 모든 구동 부위는 제품 구동 시 원활한 작동이 가능하도록 조립 과정에서 윤활제(양초)양초를 발라 주세요.

## SPA

**Instrucciones de montaje:**  
Saque de la tabla las piezas marcadas en el esquema. Trate de no romperlas. Si una pieza no se saca, haga una incisión. La construcción va sin pegamento. Si tiene dificultades con la instalación del eje de madera en un agujero, frote primero el eje o las piezas contra una vela. Para un mejor deslizamiento, lubrique durante el montaje las piezas móviles del mecanismo con una vela común.

## ITA

**Istruzioni di montaggio:**  
Estrarre dal telaio i particolari indicati nello schema. Fare attenzione a non romperli. Se un particolare non si stacca, tagliare delicatamente gli elementi di collegamento con un coltello. L'assieme viene realizzato senza colla. In caso di difficoltà nell'inserimento di un perno in legno, è necessario sfregare il perno o il particolare con un po' di cera. Per uno scorrimento migliore incerare le parti mobili del meccanismo durante l'assemblaggio.

## JPN

**組み立て説明書:**  
部品に傷をつけないように注意しながらボードから外してください。部品が外れにくい場合は連結部分をカッターで切ってから外すと外しやすいです。本製品は、接着剤がなくても組み立てができるように設計されています。もしアクスル(駆動部)が、歯車の動きがにぶい場合は、ロウソクをアクスルに塗ってください。全ての駆動部分は製品を動かす時、滑らかに動くように潤滑剤であるロウソクを塗りながら組み立てます。

**ENG Warning! UKR Увага! FRA Attention! DEU Achtung! SPA Precaución! ITA Attenzione! JPN 注意! CHI 注意! TUR Uyarı! POL Uwaga! KOR 주의!**



**ENG Do not use a lighted candle! UKR Не підпалювати!**

**FRA Ne pas brûler! DEU Nicht anzünden!**

**SPA ¡No encender! ITA Non dare fuoco!**

**JPN 火のついたロウソクの使用はお止めください。**

**CHI 请勿点燃，请勿靠近火源! TUR Yanar haldeki mumu kullanmayınız!**

**POL Nie podpalac! KOR 불이 붙은 초를 이용하지 마세요!**



**ENG** Wax the part with a regular candle (rub with a candle). **UKR** Змастіть деталь звичайною свічкою (потріть об свічку). **FRA** Lubrifiez la pièce avec une bougie ordinaire (frottez contre la bougie). **DEU** Reiben Sie das Teil mit einer einfachen Kerze etwas ein. **SPA** Engrase la pieza con una vela común (frote con una vela). **ITA** Incerare il componente (Sfregare con la cera). **JPN** された部分に潤滑剤としてろうソクを塗ってください。 **CHI** 用普通蜡烛涂抹润滑部件 **TUR** Parçayı normal bir mum ile cilalayınız (bir mum ile ovunuz). **POL** Przesmaruj zwykłą świecą. **KOR** 표시된 부분에 윤활을 위해 초를 칠해 주세요.



**ENG** Sand to remove burrs. **UKR** Видалить задирки. **FRA** Éliminez les bavures. **DEU** Grate entfernen. **SPA** Quite las rebabas. **ITA** Togliere le bave. **JPN** バリ取りのサンドペーパー **CHI** 磨掉毛刺 **TUR** Pürüzleri temizlemek için zımpara kullanınız. **POL** Usuń zadziory. **KOR** 거친 부분을 다듬어 주세요.



**ENG** Pay attention. Check position of the part. **UKR** Зверніть увагу. Перевірте розташування елемента. **FRA** Faites attention. Vérifiez l'adposition de l'élément. **DEU** Bitte Beachten. Prüfen Sie die Einbaulage des Elementes. **SPA** Atención. Compruebe la situación del elemento. **ITA** Prestare attenzione. Controllare la posizione del componente. **JPN** 方向及び位置に注意して組み立てて下さい。 **CHI** 注意! 检查部件方向和位置 **TUR** Dikkatli olun. Parçanın konumunu kontrol edin. **POL** Zwróć uwagę. Sprawdź lokalizację elementu. **KOR** 방향 또는 위치에 주의해서 조립해 주세요.



**ENG** Check the mechanism for smoothness and accuracy of movement. Operate the mechanism so the parts would seat-in. **UKR** Перевірте механізм на плавність і точність ходу. Розробіть механізм. **FRA** Vérifiez si le mécanisme fonctionne en douceur et avec précision. Faites fonctionner le mécanisme jusqu'à son fonctionnement normal. **DEU** Prüfen sie den Mechanismus bezüglich der Laufruhe und der Genauigkeit des Ganges. Betätigen Sie den Mechanismus mehrmals. **SPA** Verifique la suavidad y precisión del mecanismo. Desarrolle el mecanismo. **ITA** Controllare la scorrevolezza e la precisione del movimento. Far funzionare il meccanismo. **JPN** 駆動部分が滑らかに動くかを確認しながら作業をすすめます。 **CHI** 检查机构的运行平稳度和精密度。调整机构。 **TUR** Pürüzsüzlüğü ve hareketin isabetliliği için mekanizmayı kontrol edin. Mekanizmayı çalıştırın ki böylece parçalar yerlerine otursun. **POL** Sprawdź płynność i dokładność ruchu mechanizmu. Dopracuj mechanizm. **KOR** 구동 부분의 원활한 작동과 정확한 움직임을 확인하세요.



**ENG** The part should be easily rotated (moved). **UKR** Деталь повинна легко крутитися (рухатися). **FRA** La pièce doit tourner (se déplacer) aisément. **DEU** Der Teil soll leicht gedreht (bewegt) werden. **SPA** La pieza debe ser fácil de girar (mover). **ITA** Il componente deve girare (muoversi) facilmente. **JPN** 部品はしっかりと動かなければなりません。 **CHI** 此部件必须容易的旋转 (移动) **TUR** Parça kolaylıkla döndürülmelidir (hareket ettirilmelidir). **POL** Element powinien łatwo się kręcić (poruszać się). **KOR** 활하게 움직일 수 있어야 합니다.



**ENG** Specified details come with spare duplicates. **UKR** Зазначені деталі є на дошках як запасні. **FRA** Les détails spécifiés sont fournis avec des doublons de rechange. **DEU** Die angegebenen Details werden mit Ersatzduplikaten geliefert. **SPA** Los detalles especificados vienen con duplicados de repuesto. **ITA** I dettagli specificati vengono forniti con duplicati di riserva. **JPN** 指定された詳細には予備の複製が付属しています。 **CHI** 指定的細節帶有備用副本。 **TUR** Belirli ayrıntılar yedek parçalar ile birlikte gelmektedir. **POL** Zapasowe elementy są zaznaczone na desce. **KOR** 명시된 세부 사항은 여분의 복사본과 함께 제공됩니다.



**ENG** This is not a structural component; it is a tool for measurement and assembly. **UKR** Це не деталь конструкції, а допоміжний інструмент для складання або вимірювання відстаней. **FRA** Cette pièce ne fait pas partie de la construction mais constitue un outil annexe pour l'assemblage ou la mesure des distances. **DEU** Es ist kein Teil der Konstruktion, sondern ein Hilfselement für den Zusammenbau oder für das Messen der Abstände. **SPA** No es una pieza de la construcción sino un instrumento auxiliar para montar o para medir distancias. **ITA** Non è un componente del modello, ma un'attrezzatura aggiuntiva per il montaggio o il rilievo delle quote. **JPN** この部品は完成時の部品ではなく、組み立てをサポートしたり測定する道具です。 **CHI** 这不是装配零部件，是一种测量及安装辅助工具。 **TUR** Bu yapısal bir bileşen değildir; ölçüm ve birleştirme yapmak için kullanılan bir araçtır. **POL** To nie detal konstrukcji, a pomocnicze narzędzie dla montażu i wymiaru odległości. **KOR** 이 부품은 조립을 위한 부품이 아니고 조립을 돕거나 측정을 위한 도구입니다.

**ENG** This is not a structural component; it is a tool for measurement and assembly. **UKR** Це не деталь конструкції, а допоміжний інструмент для складання або вимірювання відстаней. **FRA** Cette pièce ne fait pas partie de la construction mais constitue un outil annexe pour l'assemblage ou la mesure des distances. **DEU** Es ist kein Teil der Konstruktion, sondern ein Hilfselement für den Zusammenbau oder für das Messen der Abstände. **SPA** No es una pieza de la construcción sino un instrumento auxiliar para montar o para medir distancias. **ITA** Non è un componente del modello, ma un'attrezzatura aggiuntiva per il montaggio o il rilievo delle quote. **JPN** この部品は完成時の部品ではなく、組み立てをサポートしたり測定する道具です。 **CHI** 这不是装配零部件，是一种测量及安装辅助工具。 **TUR** Bu yapısal bir bileşen değildir; ölçüm ve birleştirme yapmak için kullanılan bir araçtır. **POL** To nie detal konstrukcji, a pomocnicze narzędzie dla montażu i wymiaru odległości. **KOR** 이 부품은 조립을 위한 부품이 아니고 조립을 돕거나 측정을 위한 도구입니다.

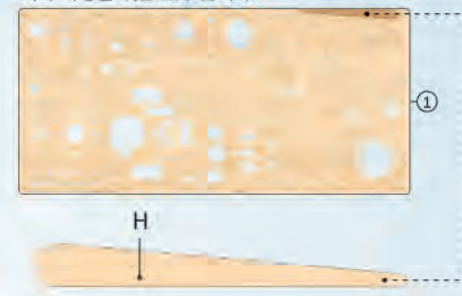
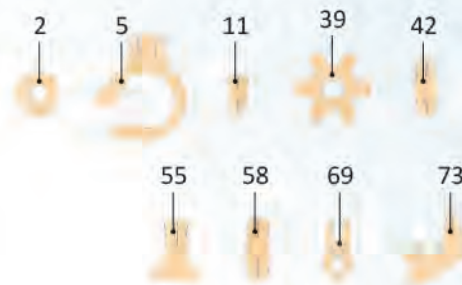

## Mechanical models



→ **ENG** It's easier to pull out some parts with the «helper (H)». **UKR** Буде легше видавити готові деталі за допомогою «helper (H)». **FRA** Il est plus facile de retirer certaines pièces avec la pièce-outils (H). **DEU** Es ist einfacher, einige Teile mit dem "Helfer (H)" herauszunehmen. Siehe Beispiel: **SPA** Para separar algunas partes resulta más fácil utilizando la ayuda del elemento "H". **ITA** È più facile estrarre alcuni elementi utilizzando l'"aiuto (H)". **JPN** ある部品は「helper (H)」を使うと取り外しやすいです。 **CHI** 使用「helper (H)」可以更轻松地拉出某些零件。 **TUR** «helper (H)» ile bazı parçaları çekip çıkarmak daha kolay olur. **KOR** 일부 부품은 'H' 도구를 이용하여 떼어내면 쉽습니다.

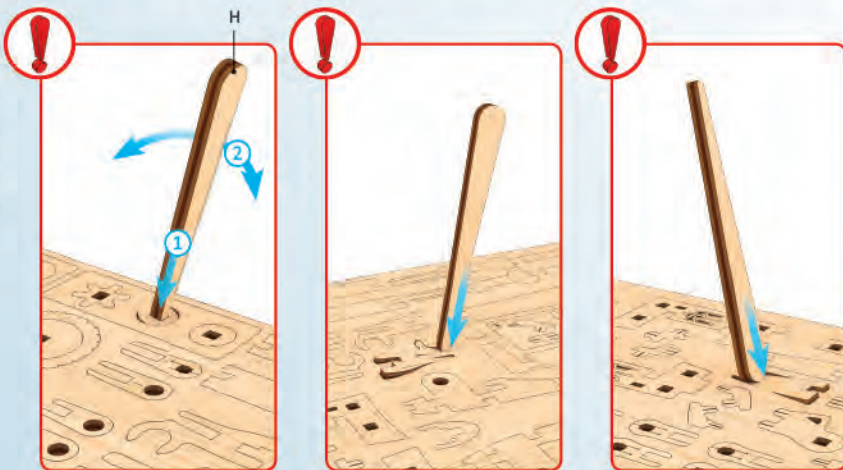

1

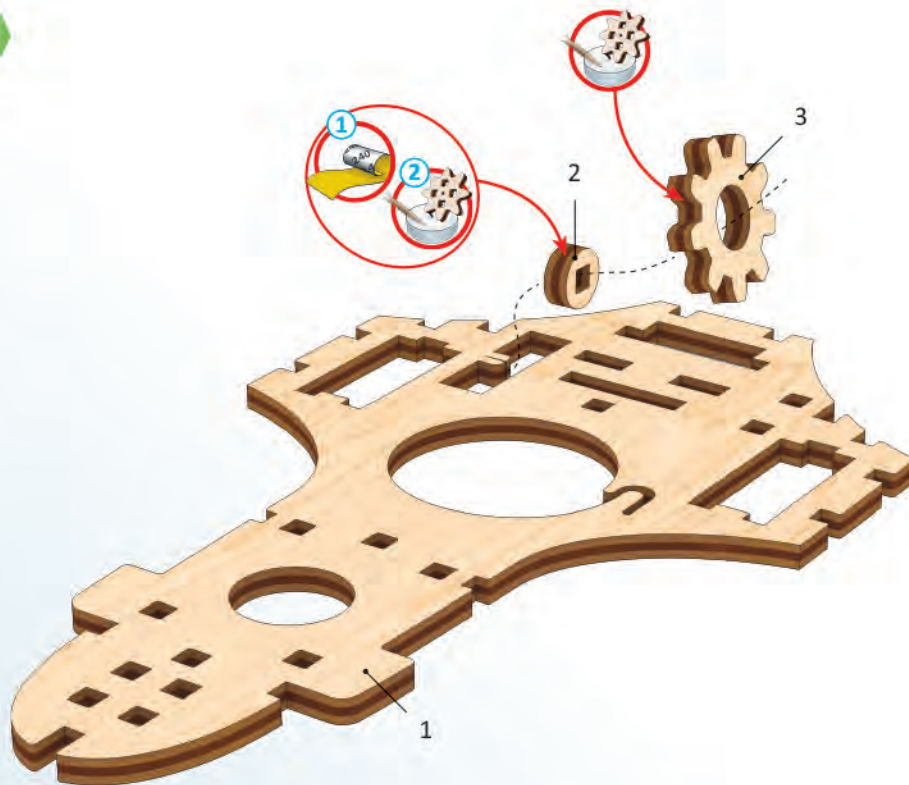

**ENG** Pay attention. Check position of the part. **UKR** Зверніть увагу. Перевірте розташування елемента. **FRA** Faites attention. Vérifiez la disposition de l'élément. **DEU** Bitte Beachten. Prüfen Sie die Einbaulage des Elementes. **SPA** Atención. Compruebe la situación del elemento. **ITA** Prestare attenzione. Controllare la posizione del componente. **JPN** 方向及び位置に注意して組み立ててください。 **CHI** 注意! 检查部件方向和位置 **TUR** Dikkatli olun. Parçanın konumunu kontrol edin. **POL** Zwróć uwagę. Sprawdź lokalizację elementu. **KOR** 방향 또는 위치에 주의해서 조립해 주세요.



**ENG** Wax the part with a regular candle (rub with a candle). **UKR** Змастіть деталь звичайною свічкою (потріть об свічку). **FRA** Lubrifiez la pièce avec une bougie ordinaire (frottez contre la bougie). **DEU** Reiben Sie das Teil mit einer einfachen Kerze etwas ein. **SPA** Engrase la pieza con una vela común (frote con una vela). **ITA** Incerare il componente (Sfregare con la cera). **JPN** された部分に潤滑剤としてろうソクを塗ってください。 **CHI** 用普通蜡烛涂抹润滑部件 **TUR** Parçayı normal bir mum ile cilalayınız (bir mum ile ovunuz). **POL** Przesmaruj zwykłą świecą. **KOR** 표시된 부분에 윤활을 위해 초를 칠해 주세요.



**ENG** Sand to remove burrs. **UKR** Видалить задирки. **FRA** Eliminez les bavures. **DEU** Grate entfernen. **SPA** Quite las rebabas. **ITA** Togliere le bave. **JPN**バリ取りのサンドペーパー **CHI** 磨掉毛刺 **TUR** Pürüzleri temizlemek için zımpara kullanınız. **POL** Usuń zadziory. **KOR** 거친 부분을 다듬어 주세요.

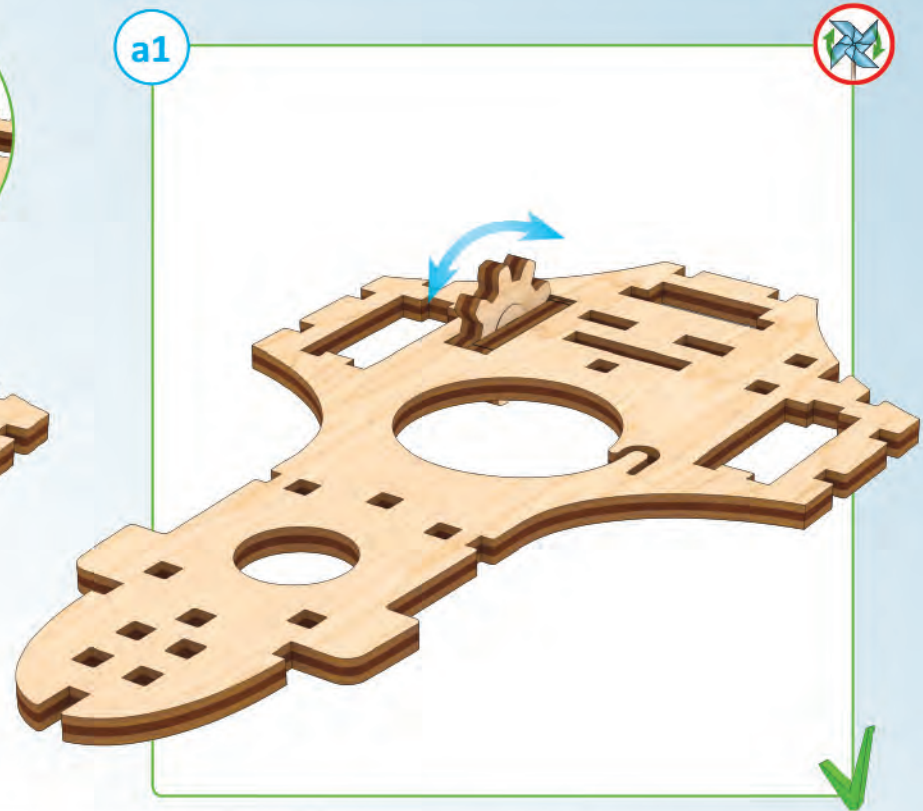
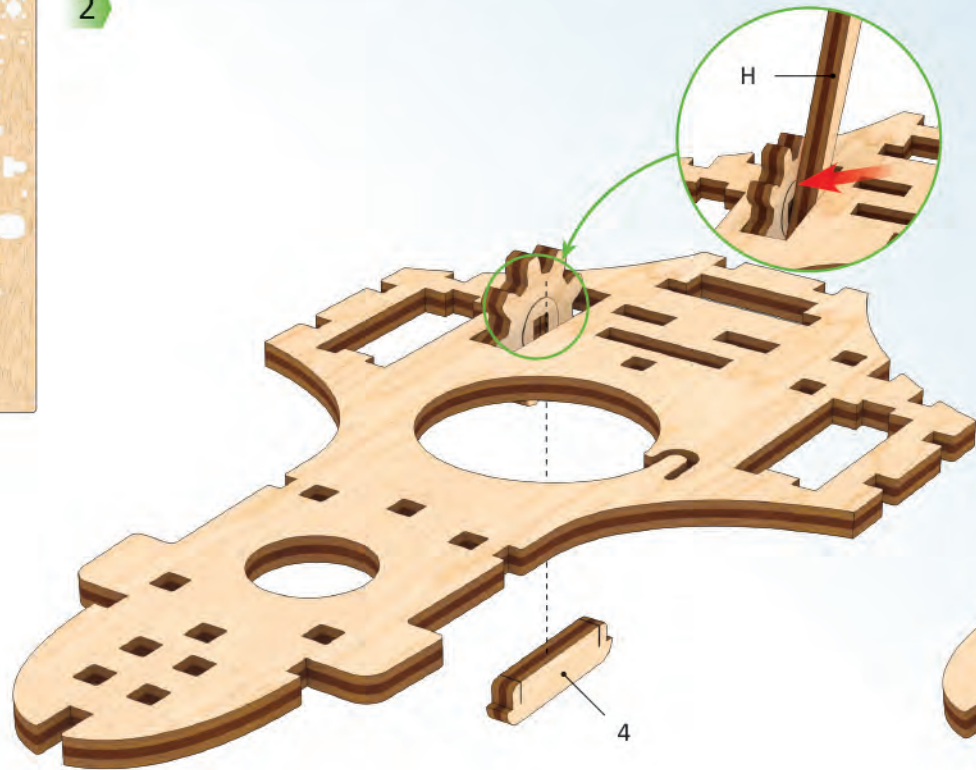
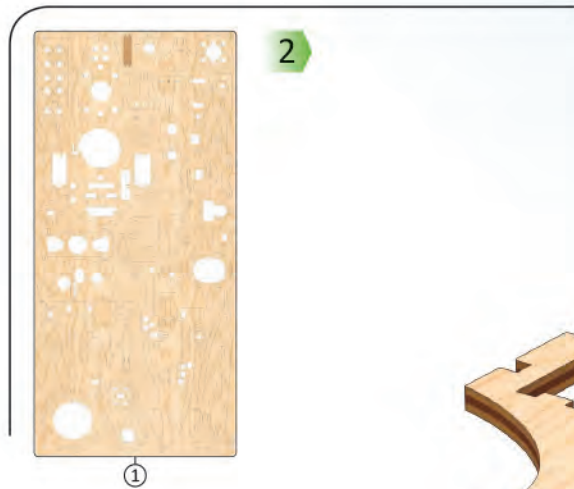

 **ENG** The part should be easily rotated (moved). **UKR** Деталь повинна легко крутитися (рухатися). **FRA** La pièce doit tourner (se déplacer) aisément. **DEU** Der Teil soll leicht gedreht (bewegt) werden. **SPA** La pieza debe ser fácil de girar (mover). **ITA** Il componente deve girare (muoversi) facilmente. **JPN** 部品はしっかりと動かなければなりません。 **CHI** 此部件必须容易的旋转 (移动) **POL** Element powinien łatwo się kręcić (poruszać się). **POR** Deve ser possível girar (mover) a peça facilmente. **KOR** 활하게 움직일 수 있어야합니다.

Mechanical models



1

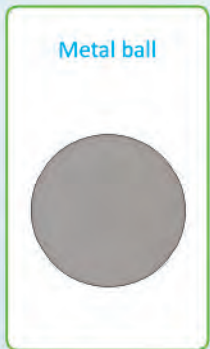

Metal ball

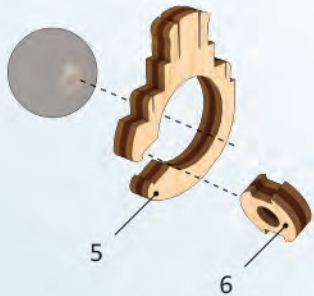

2

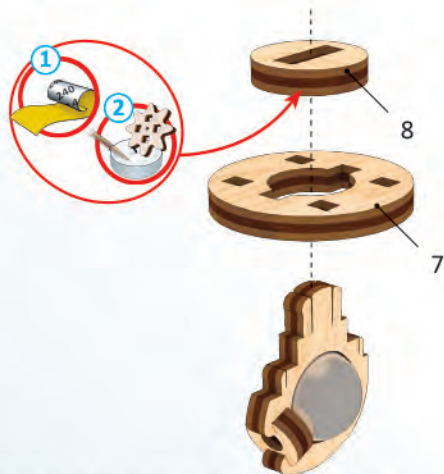

3

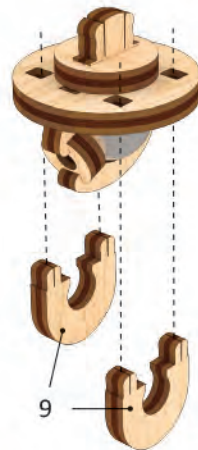

4

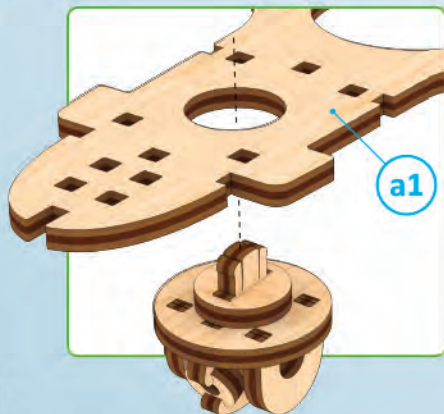

a1

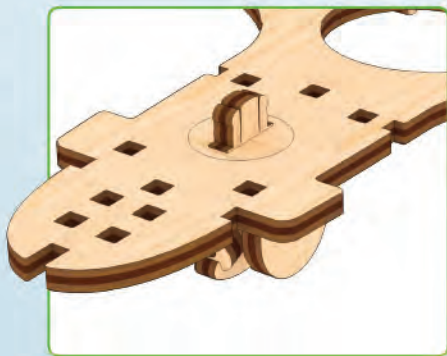

5

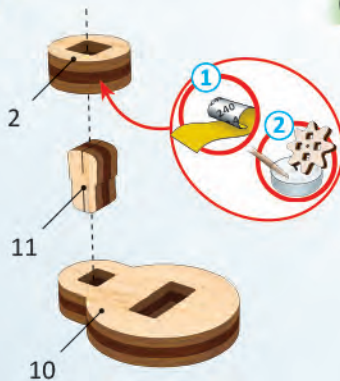

6

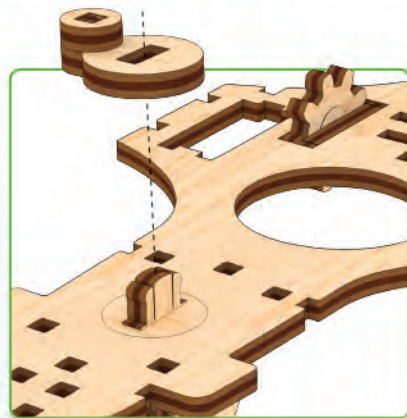

6



7

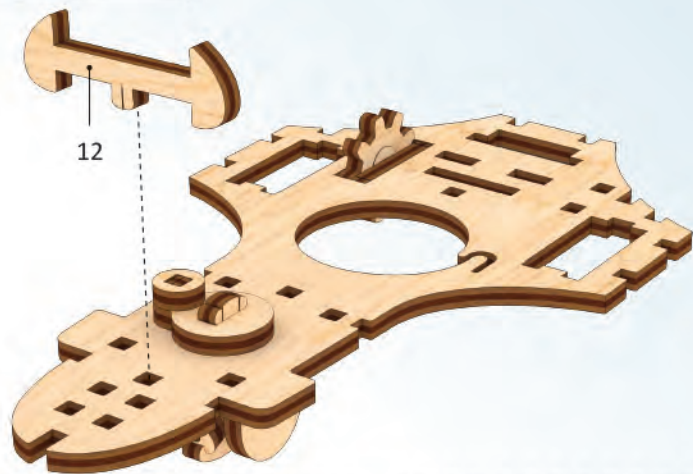

A

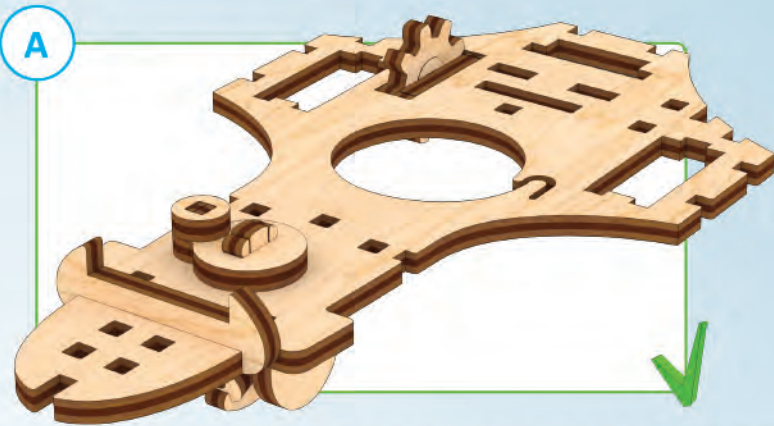

1

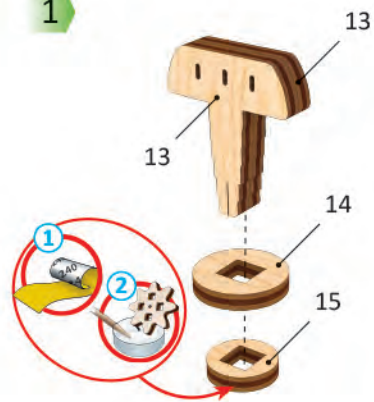

2

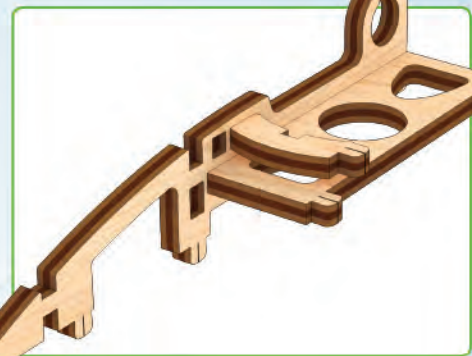
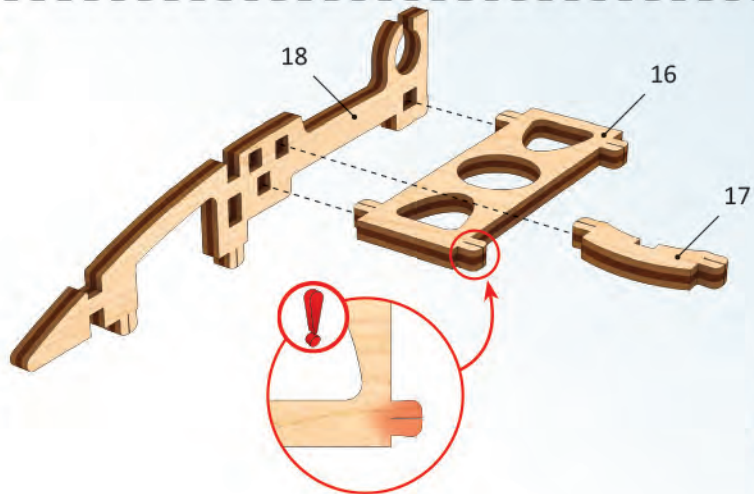

3

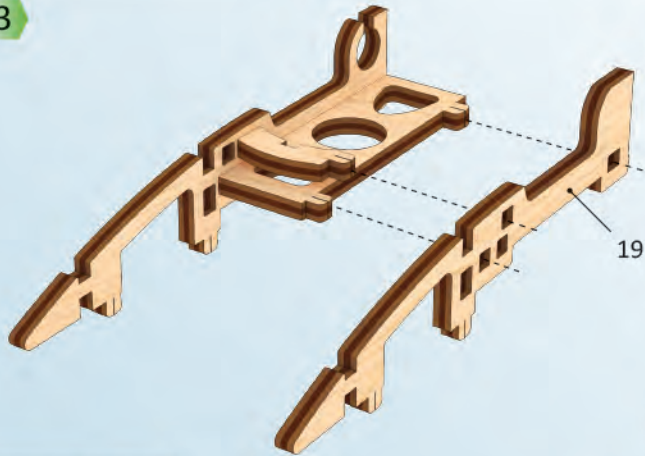

8

b1



4

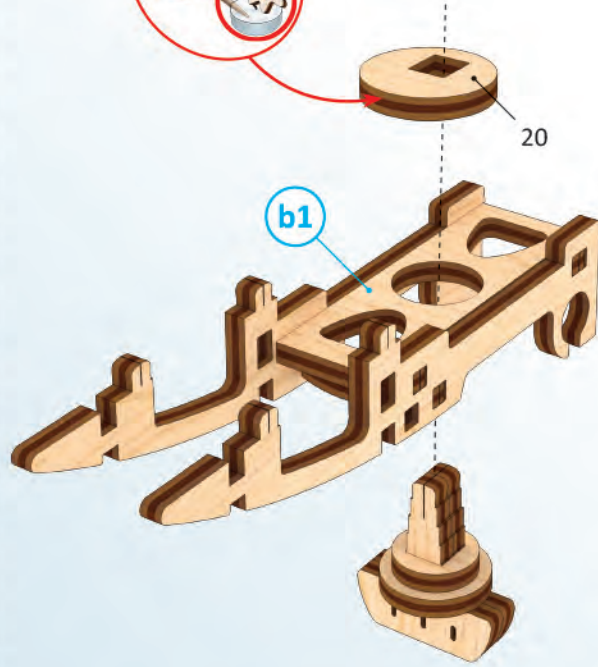

5

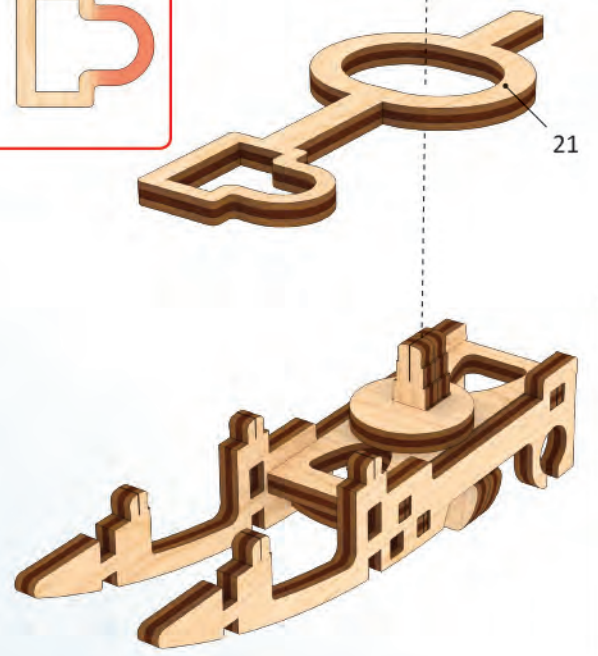
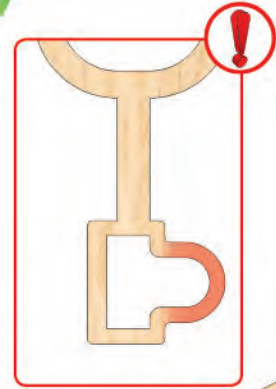



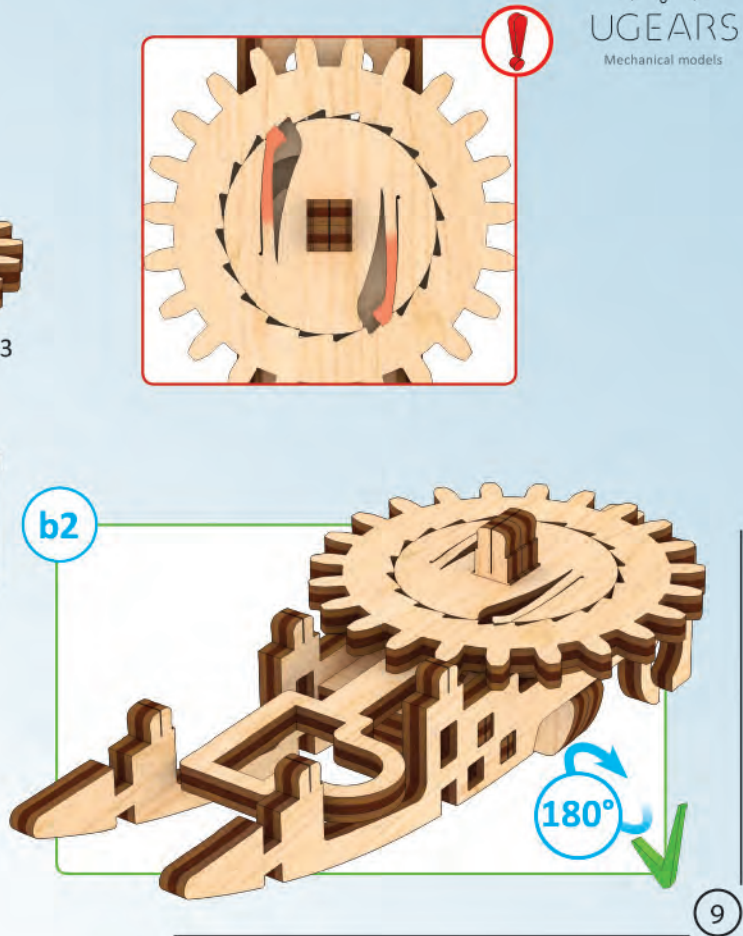
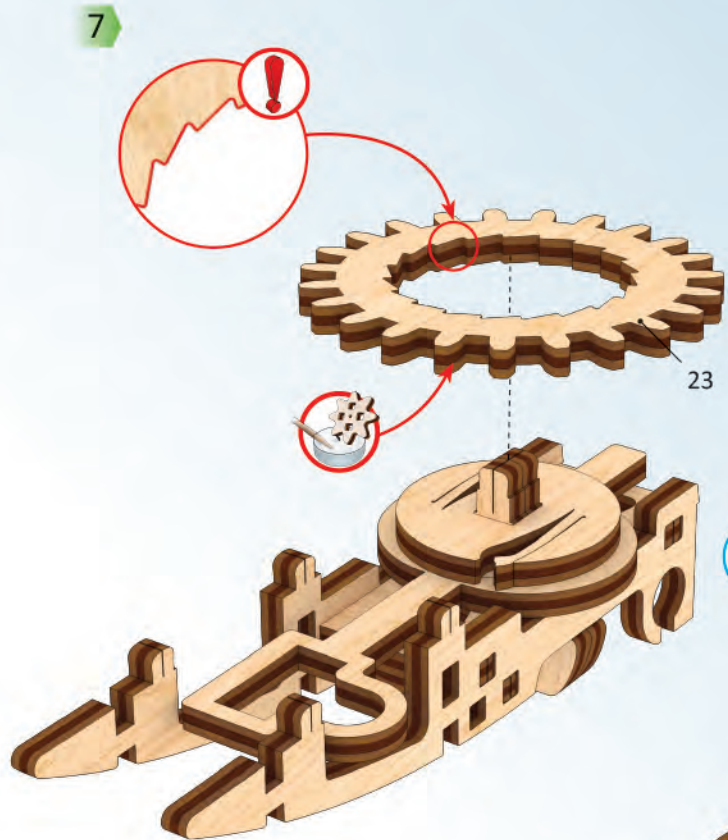
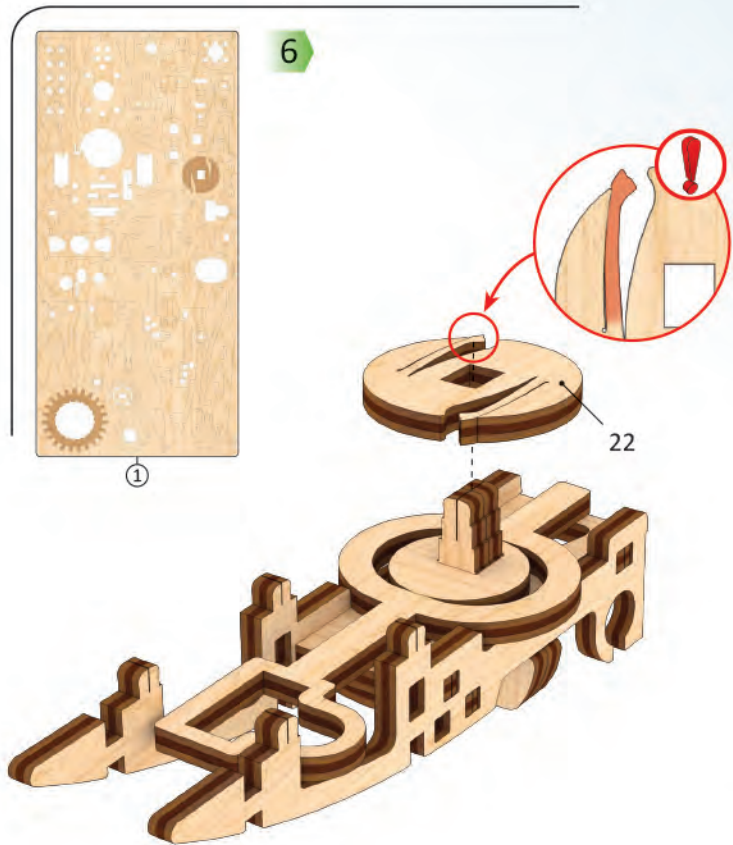

1

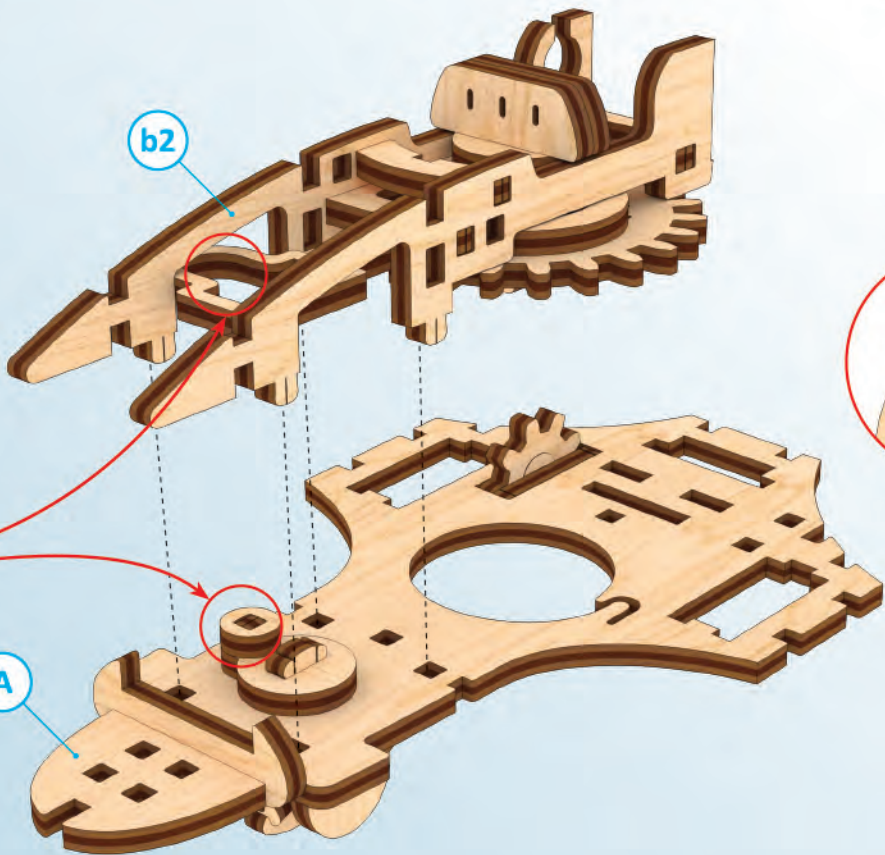

2

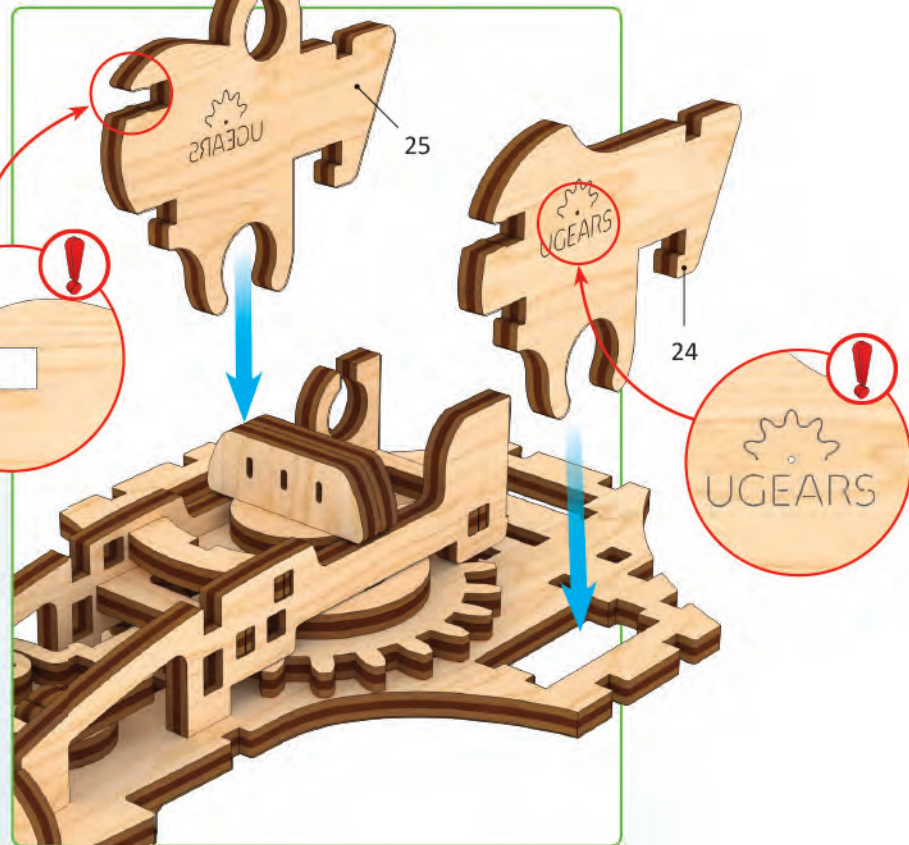

3



B



Mechanical models

1



1

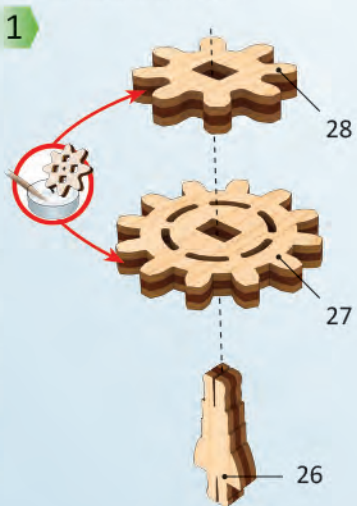

2

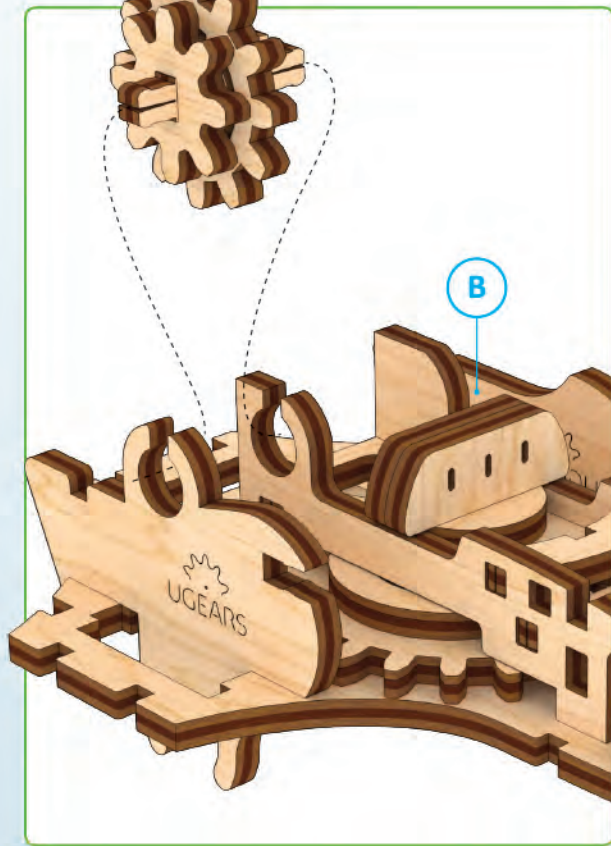

3

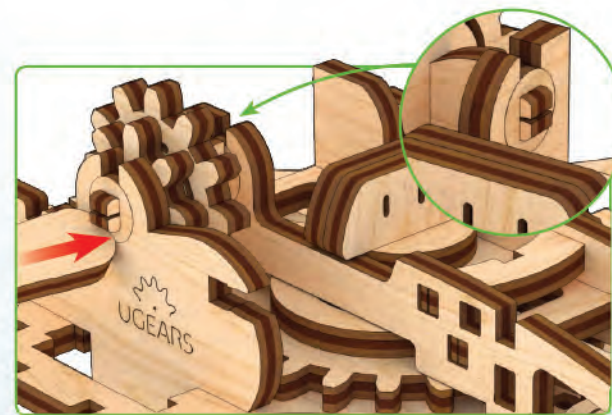
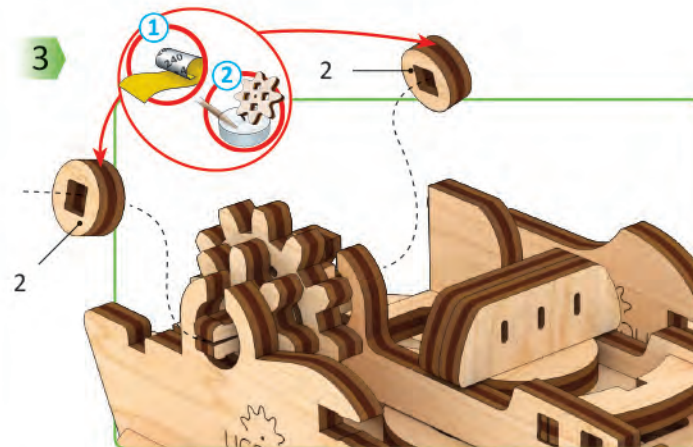

4

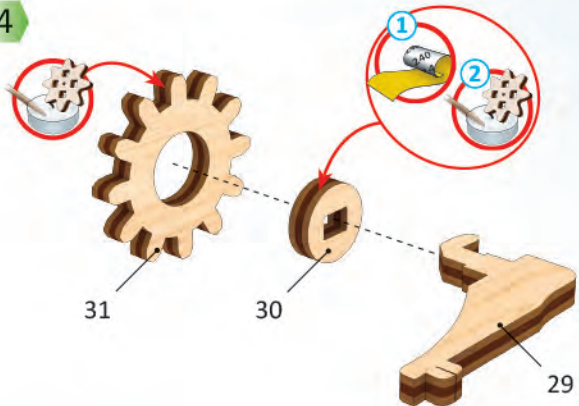

1



5

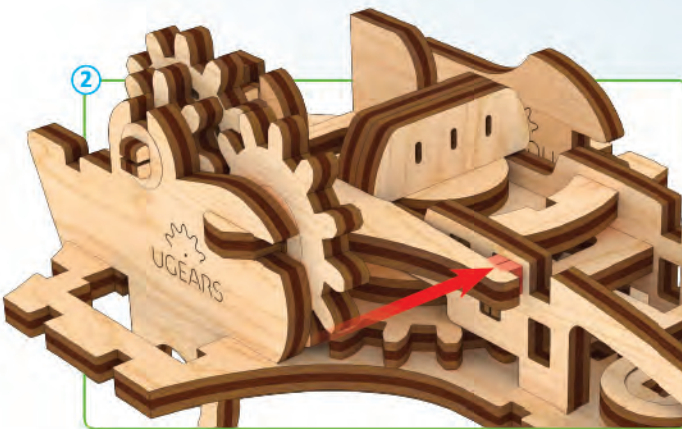
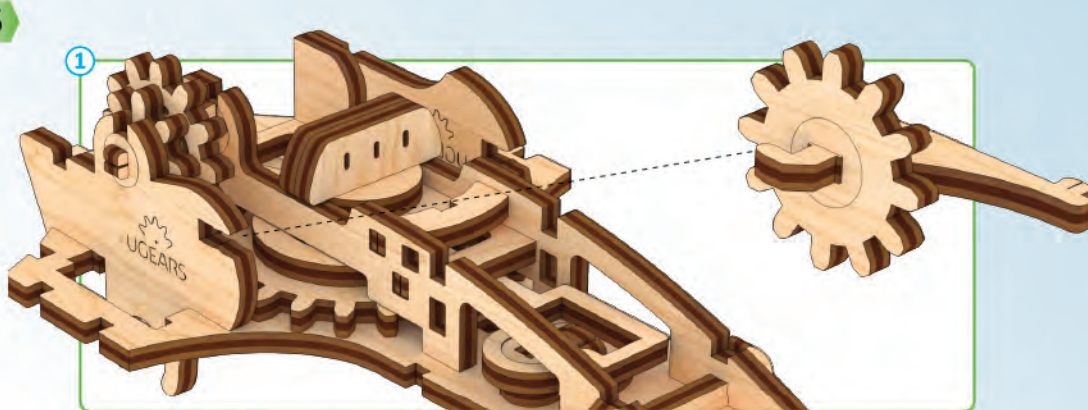

7

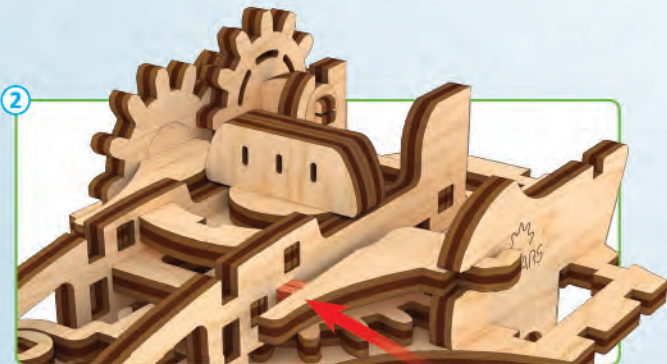
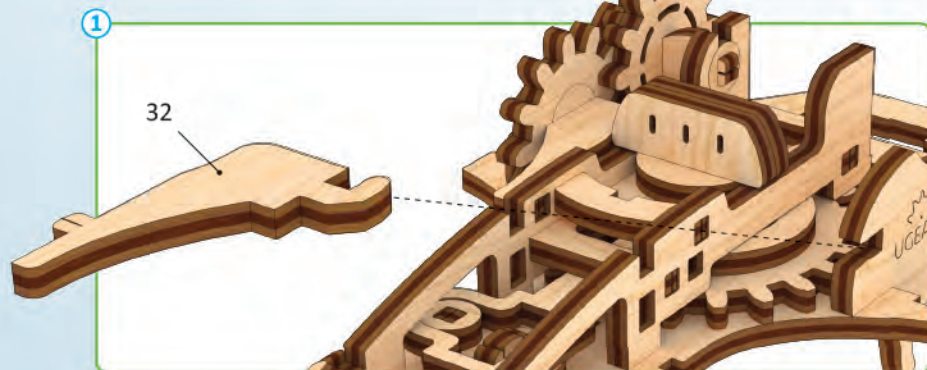

1

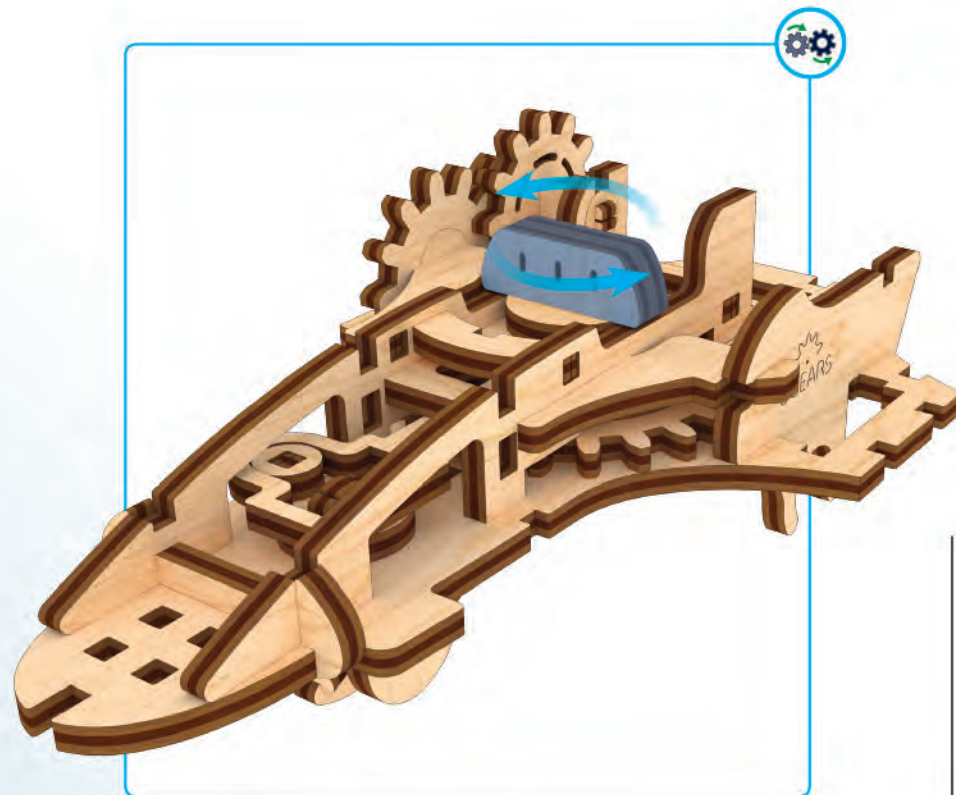

**ENG** Check the mechanism for smoothness and accuracy of movement. Operate the mechanism so the parts would seat-in. **UKR** Перевірте механізм на плавність і точність ходу. Розробіть механізм. **FRA** Vérifiez si le mécanisme fonctionne en douceur et avec précision. Faites fonctionner le mécanisme jusqu'à son fonctionnement normal. **DEU** Prüfen sie den Mechanismus bezüglich der Laufruhe und der Genauigkeit des Ganges. Betätigen Sie den Mechanismus mehrmals. **SPA** Verifique la suavidad y precisión del mecanismo. Desarrolle el mecanismo. **ITA** Controllare la scorrevolezza e la precisione del movimento. Far funzionare il meccanismo. **JPN** 駆動部分が滑らかに動くかを確認しながら作業をすすめます。 **CHI** 检查机构的运行平稳度和精密度。调整机构。 **TUR** Pürüzsüzlüğü ve hareketin isabetliliği için mekanizmayı kontrol edin. Mekanizmayı çalıştırın ki böylece parçalar yerlerine otursun. **POL** Sprawdź płynność i dokładność ruchu mechanizmu. Dopracuj mechanizm. **KOR** 구동 부분의 원활한 작동과 정확한 움직임을 확인하세요.

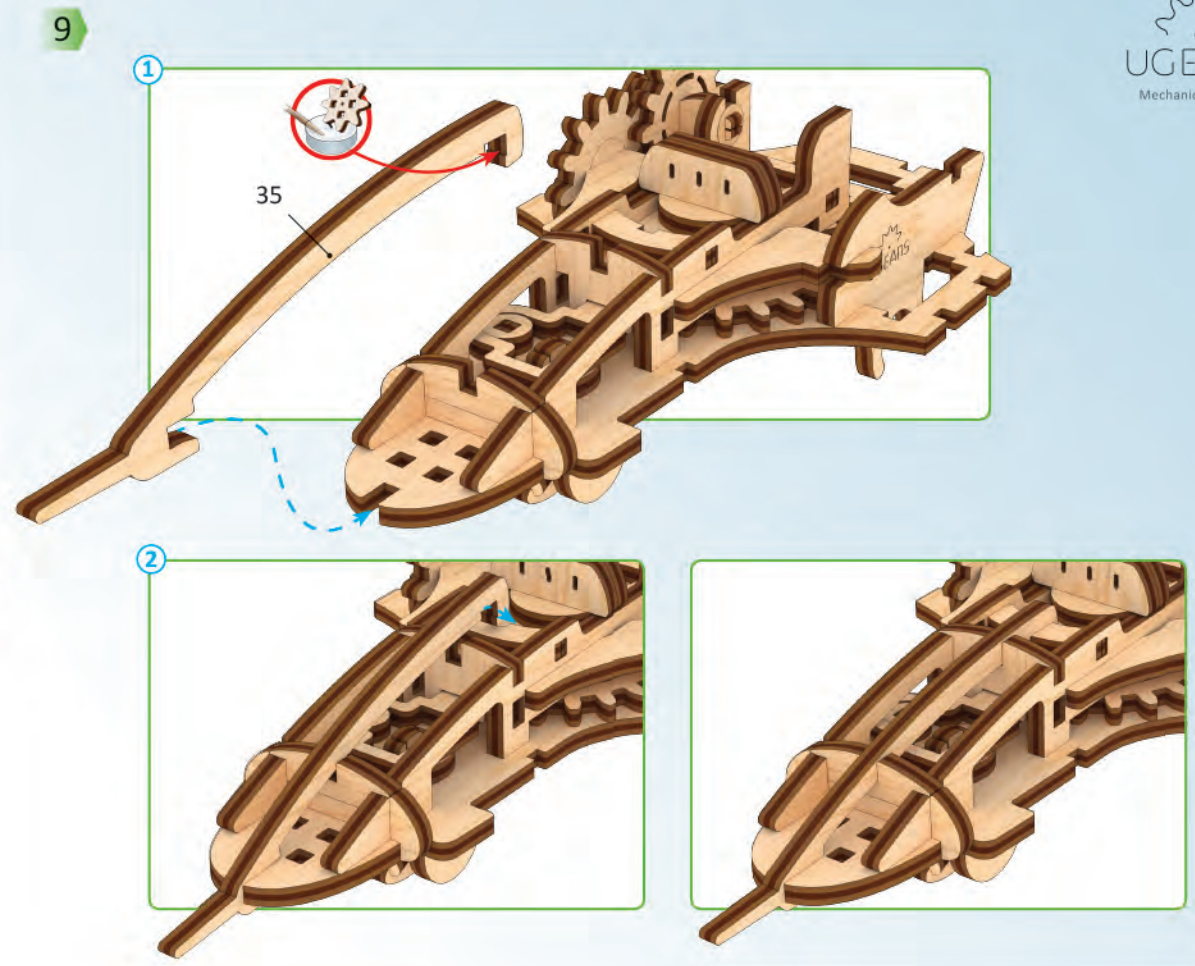
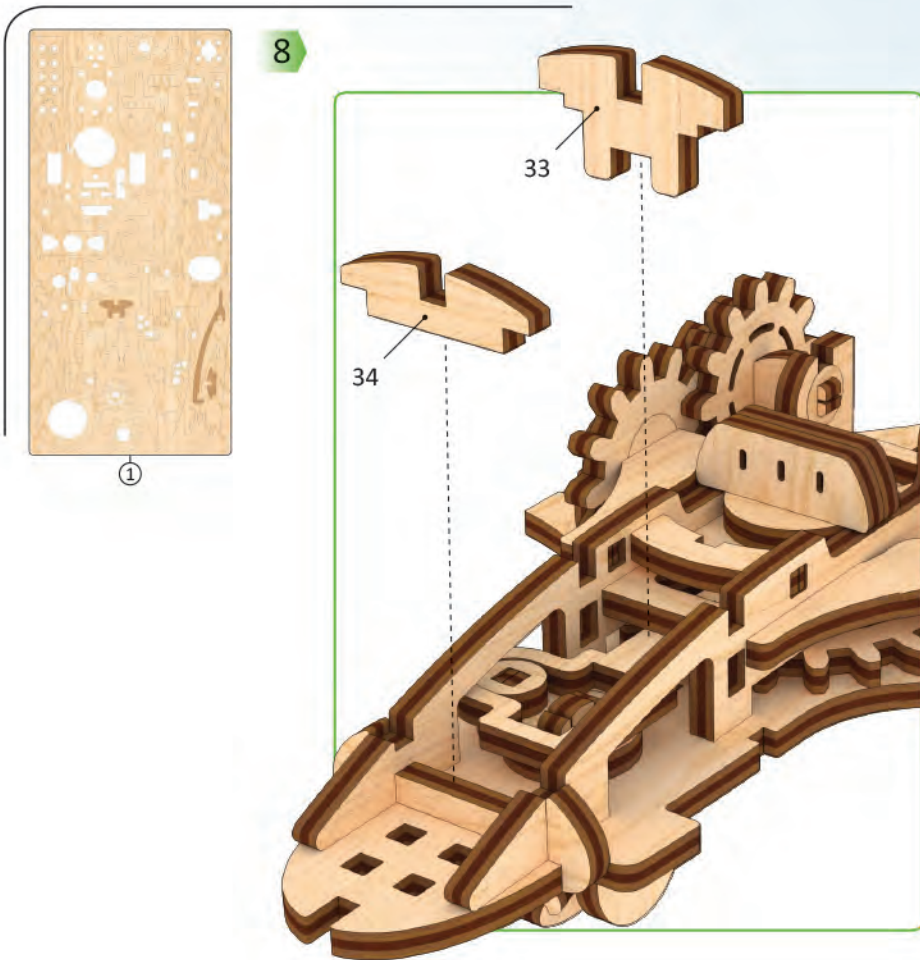

10

36

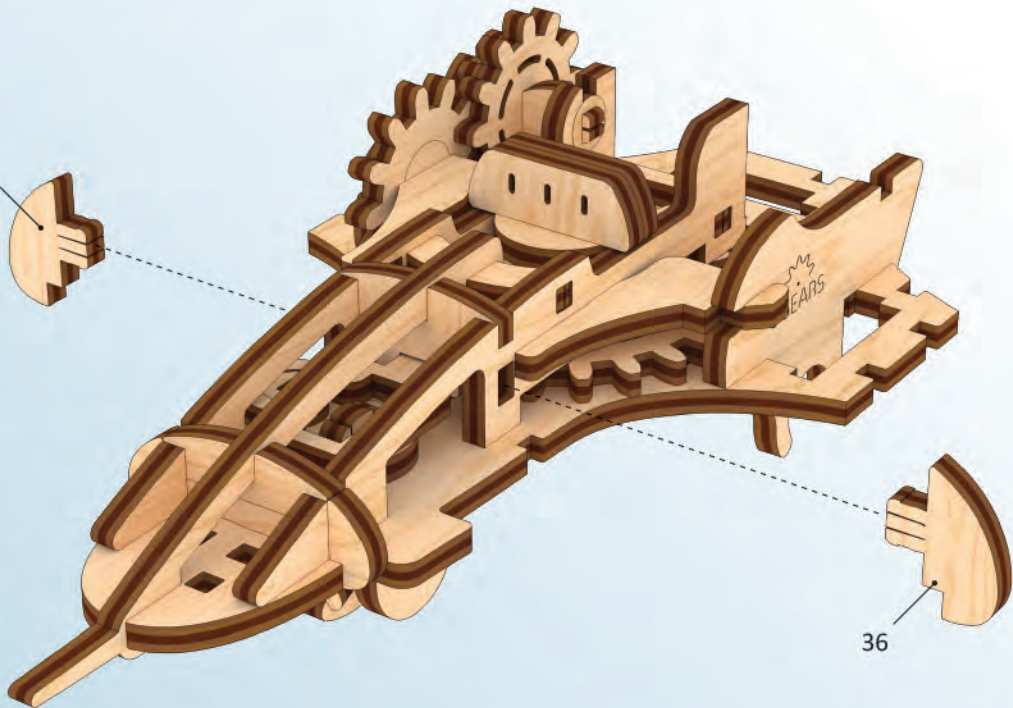

16

1

36

C

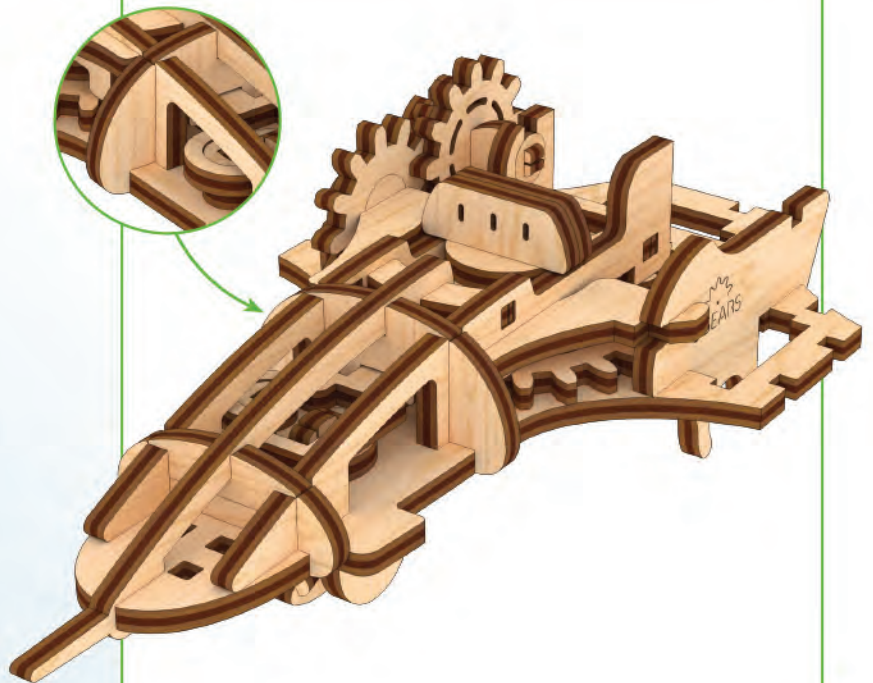



1

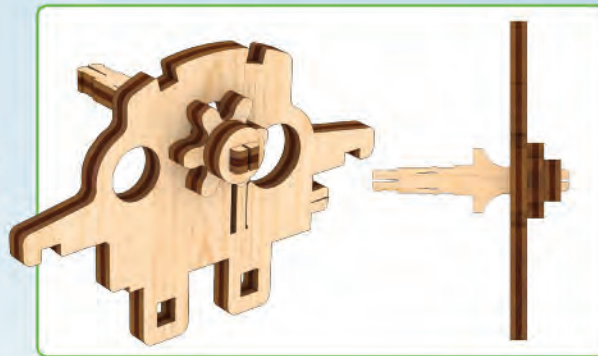
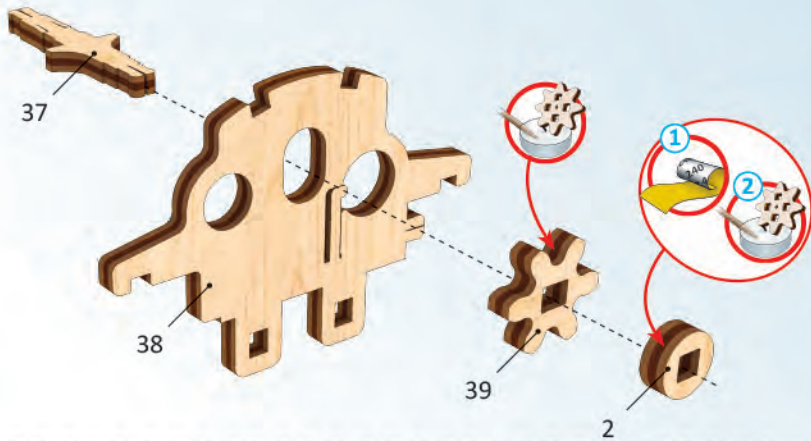
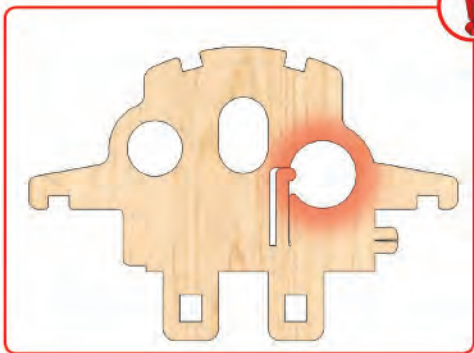

①

2

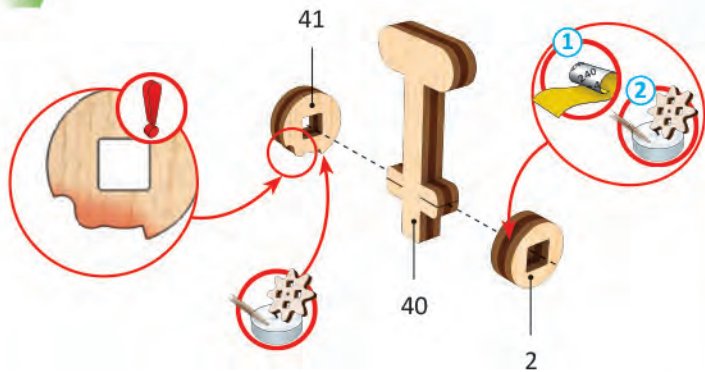

3

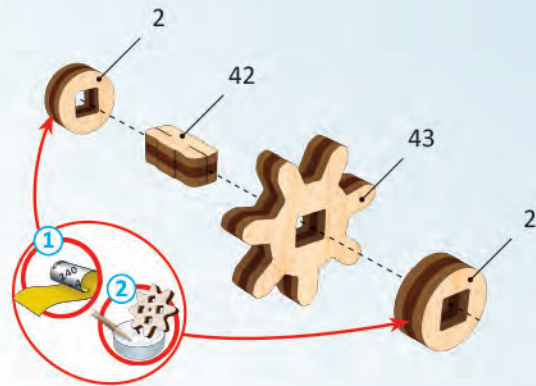



②

4

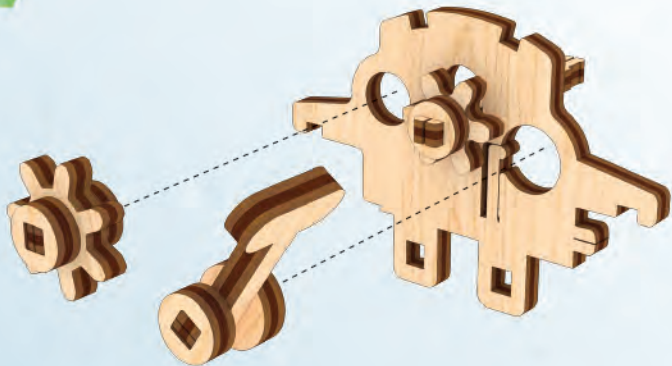

5

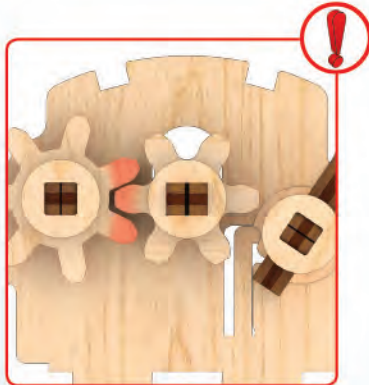

44

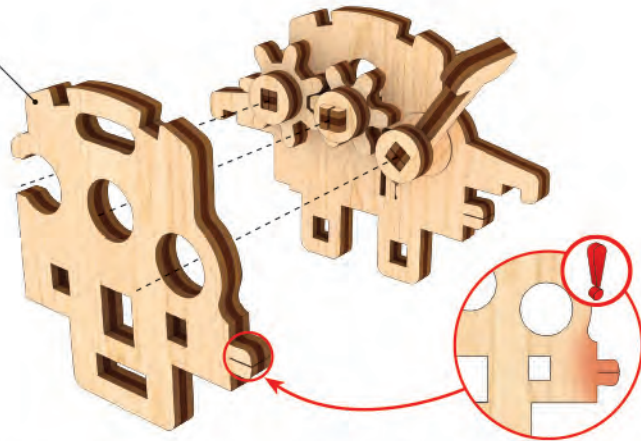

6

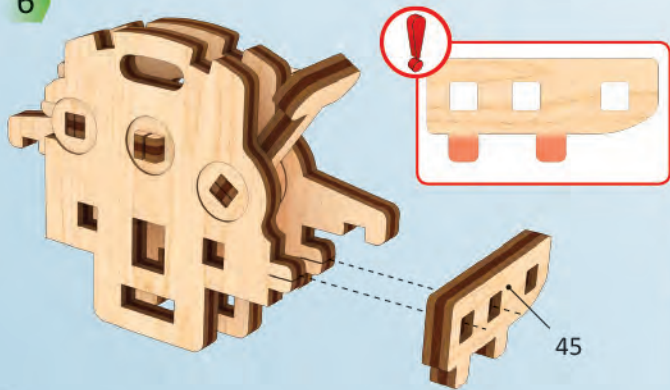

45

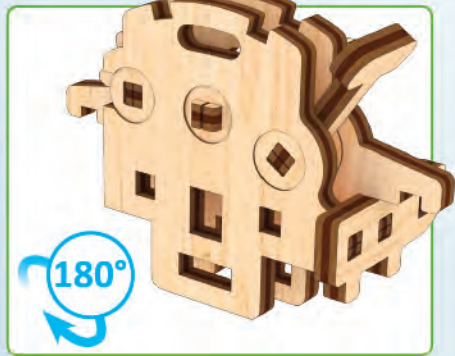

7

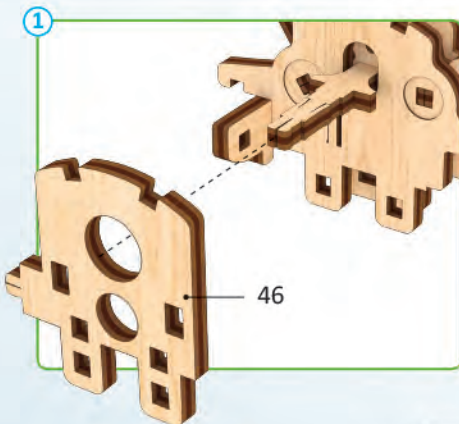

46



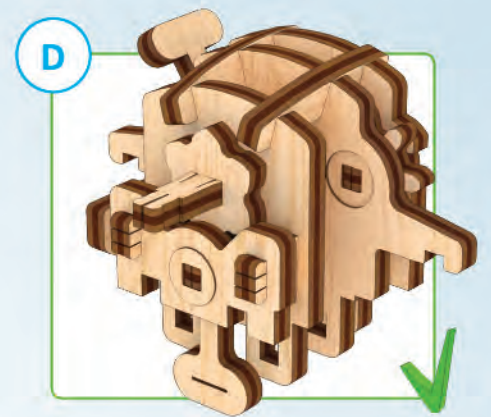
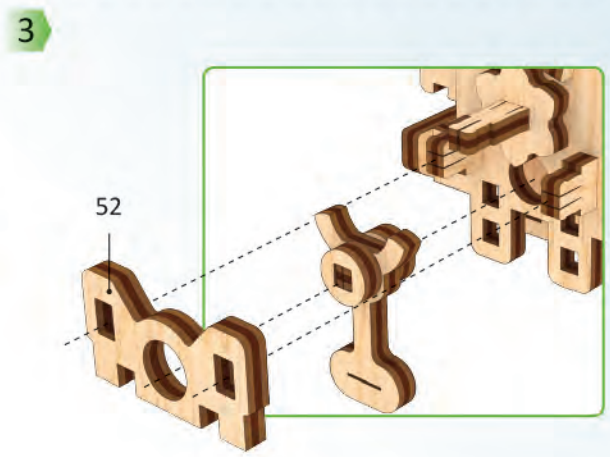
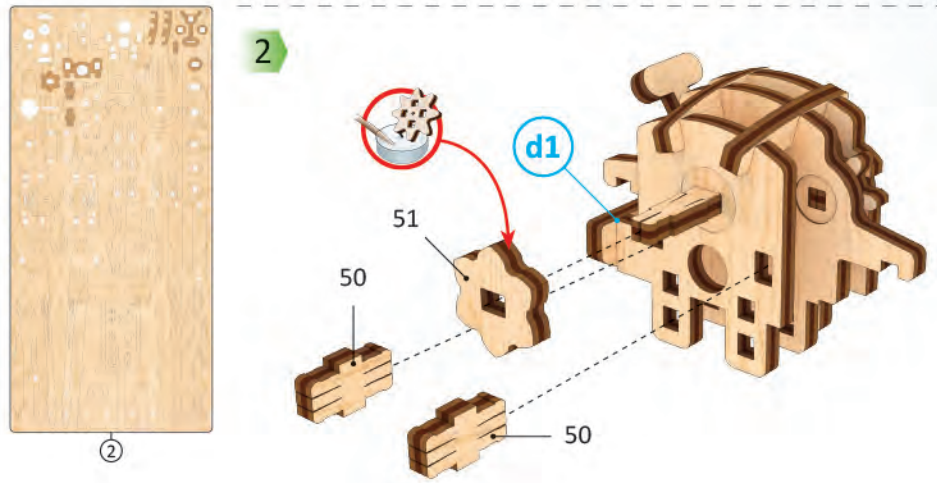
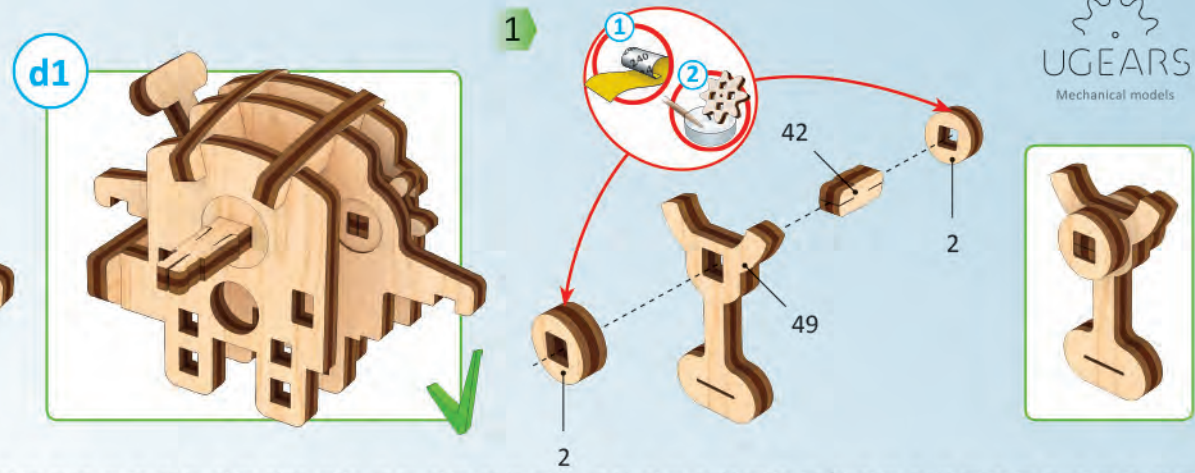
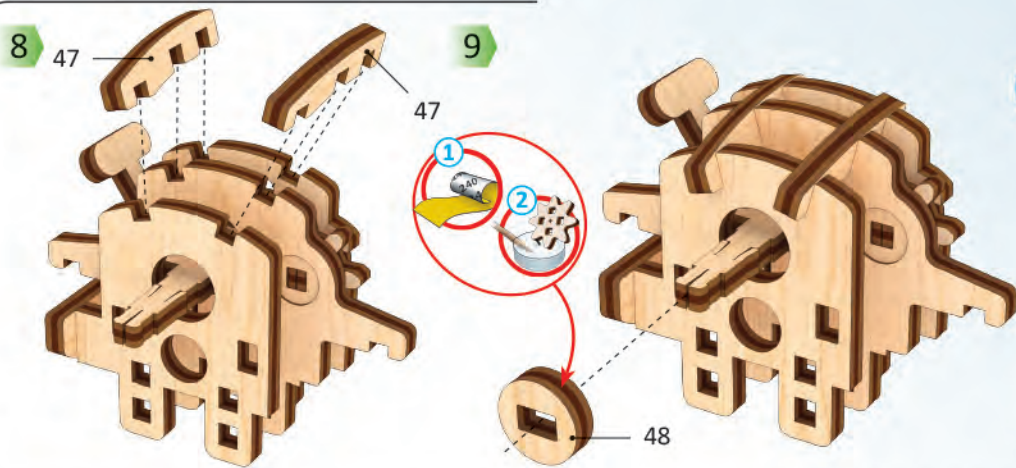

1



2

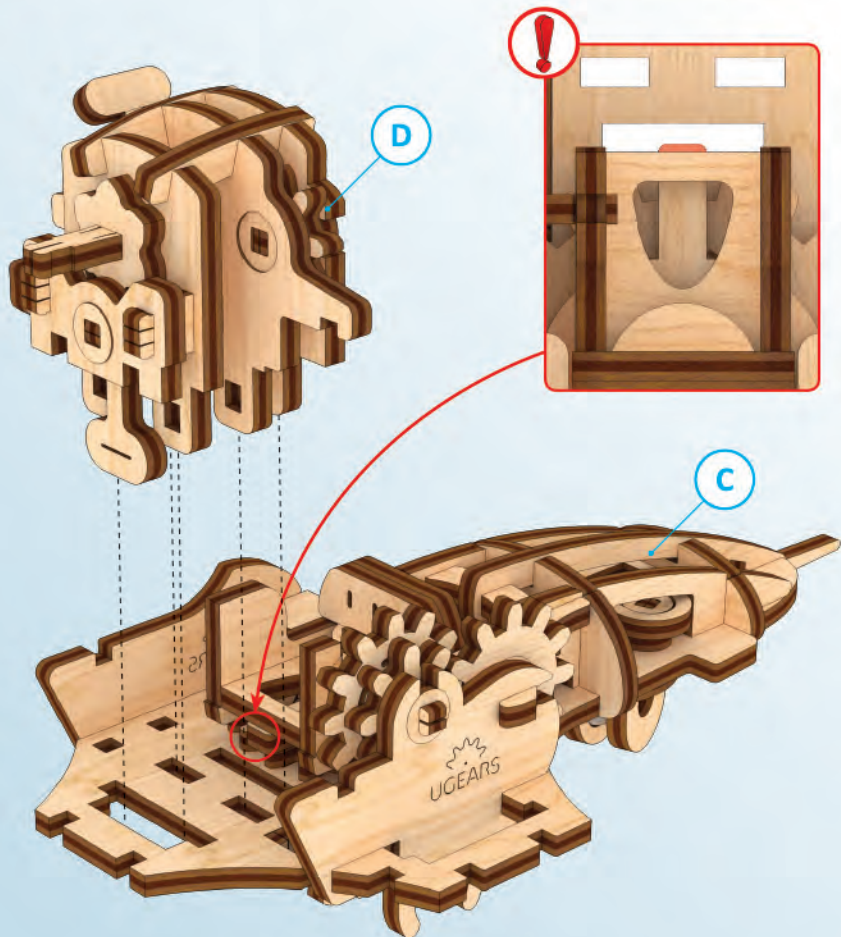

2

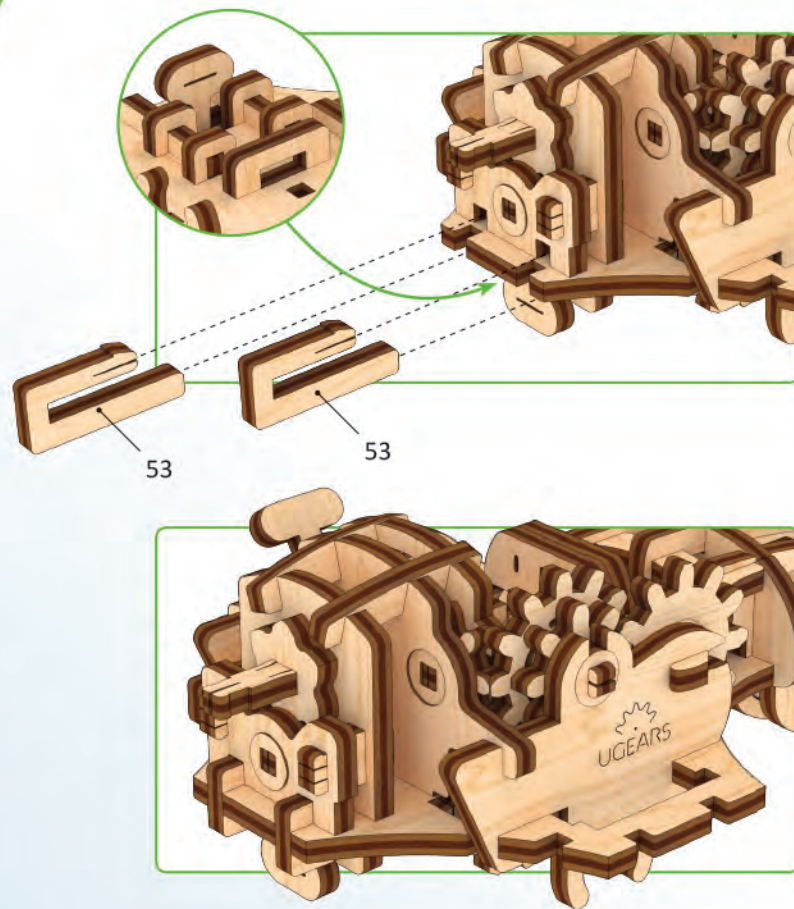

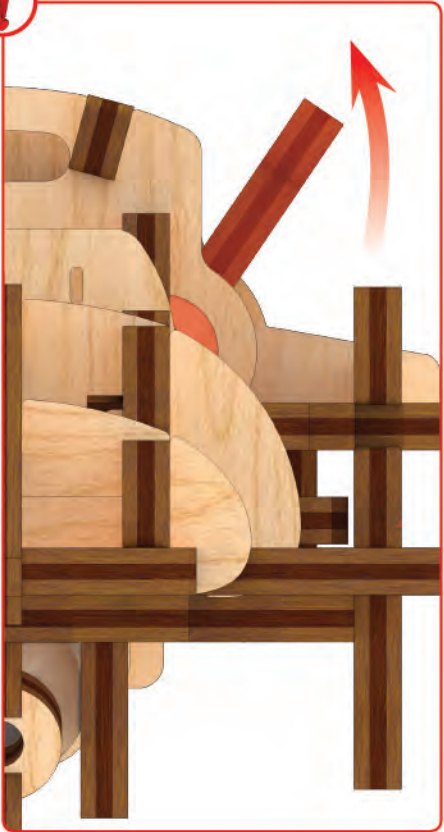

E

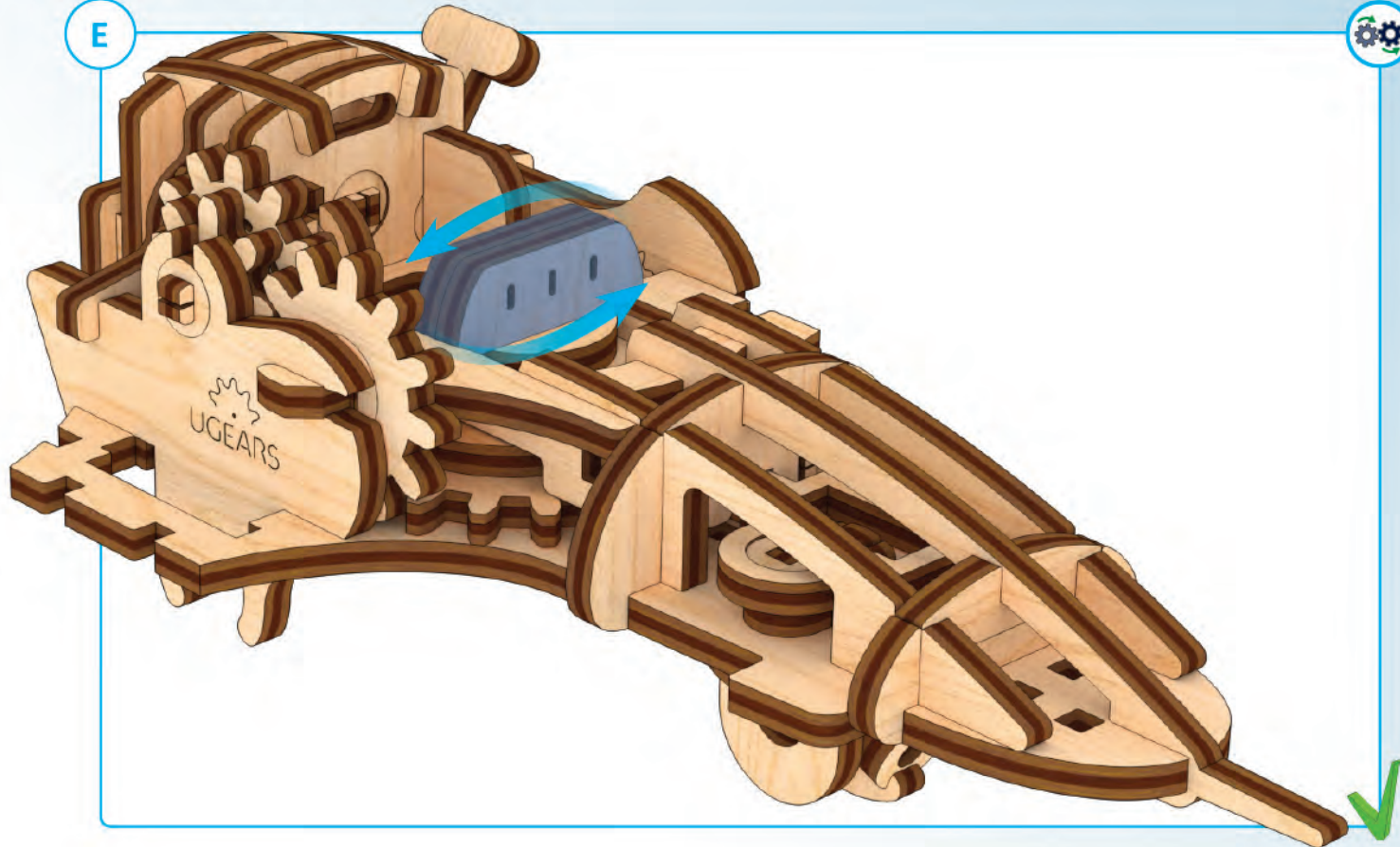

1

Metal spring

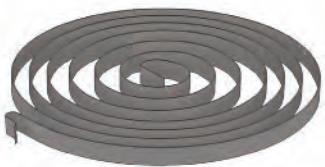

1

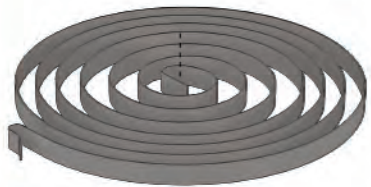

E

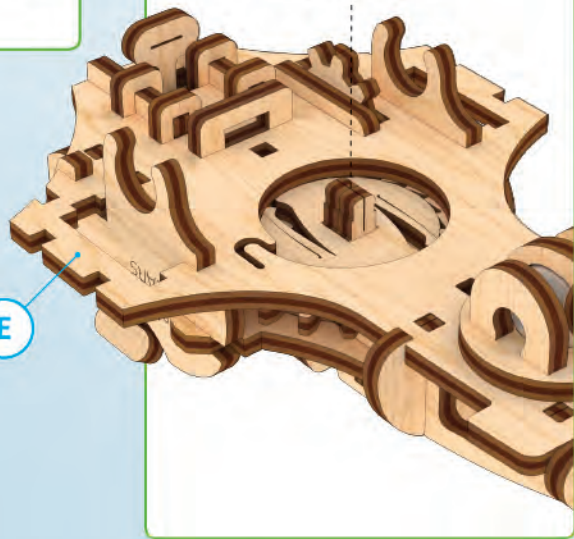

2

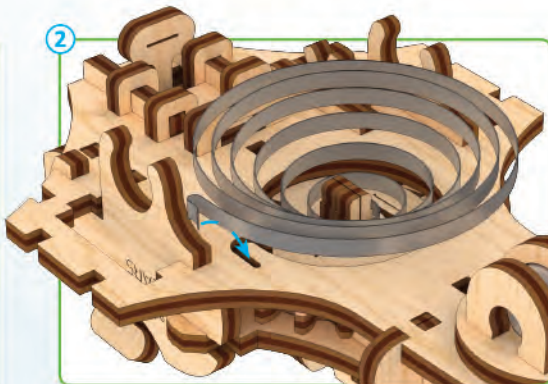

3

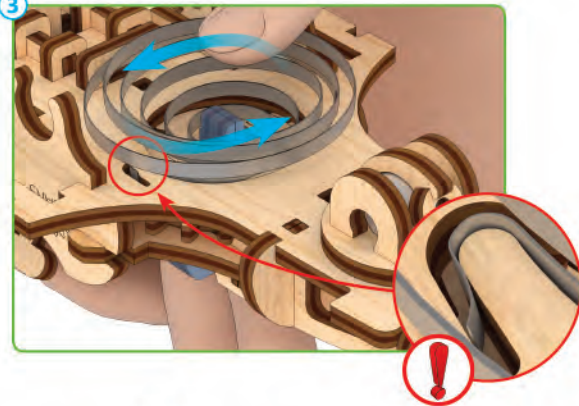

2

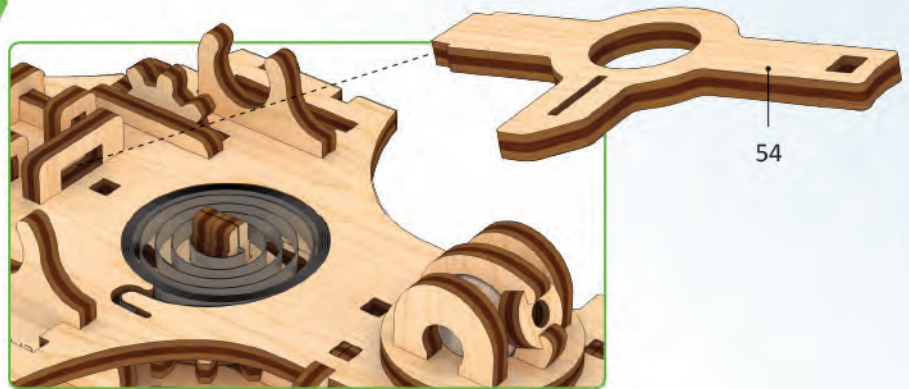

3

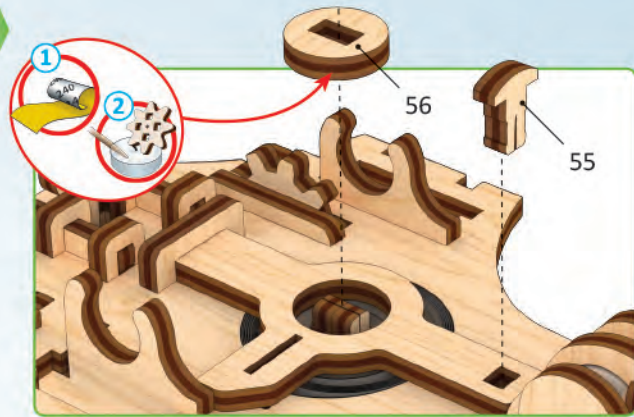

4



2

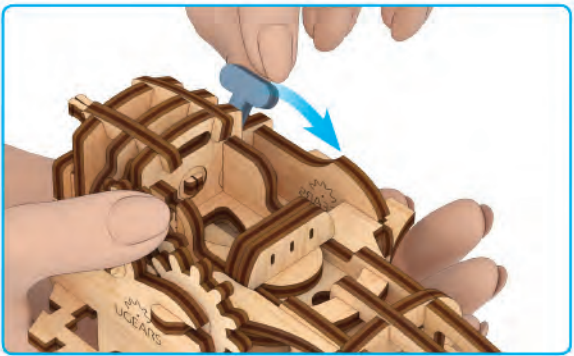

180°  
x 6-7

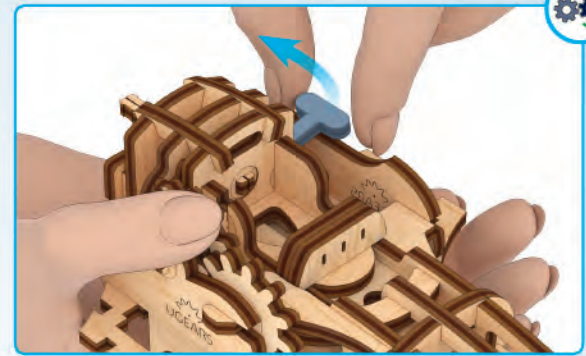

4

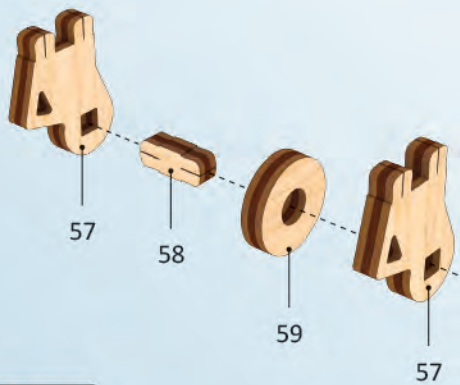

5

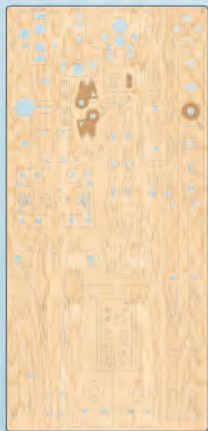
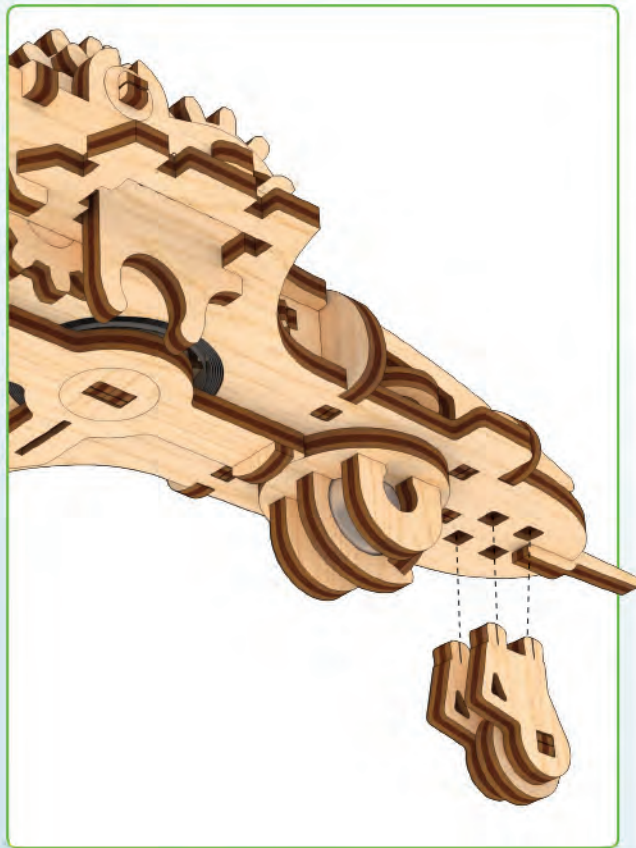

2



6

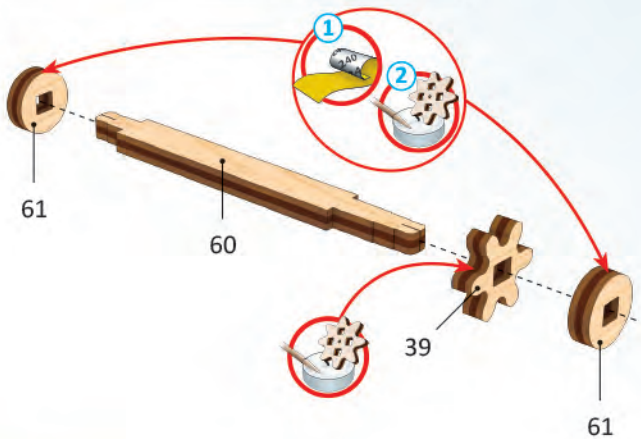

7

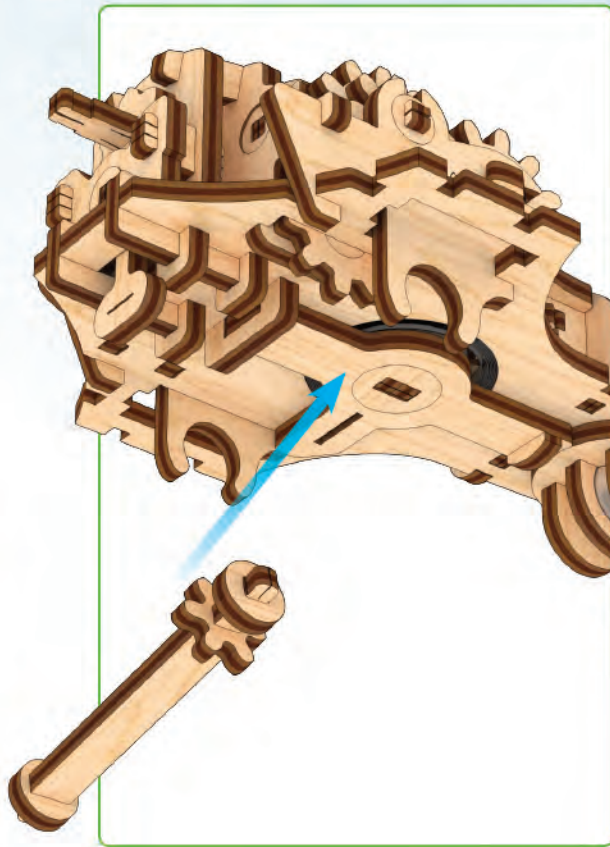

2

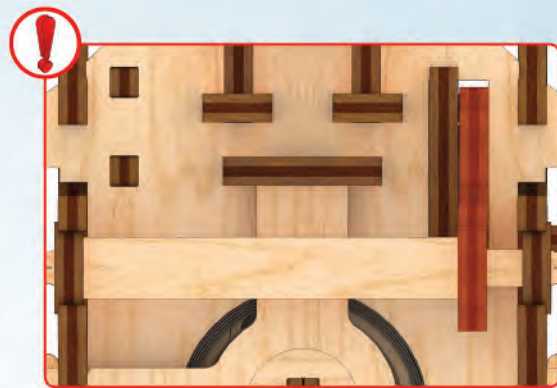
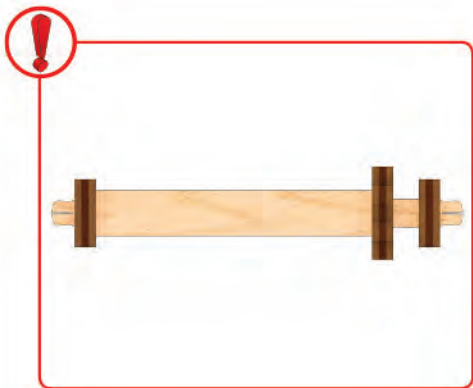

8

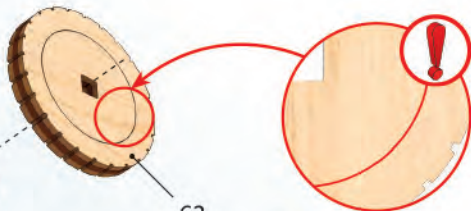
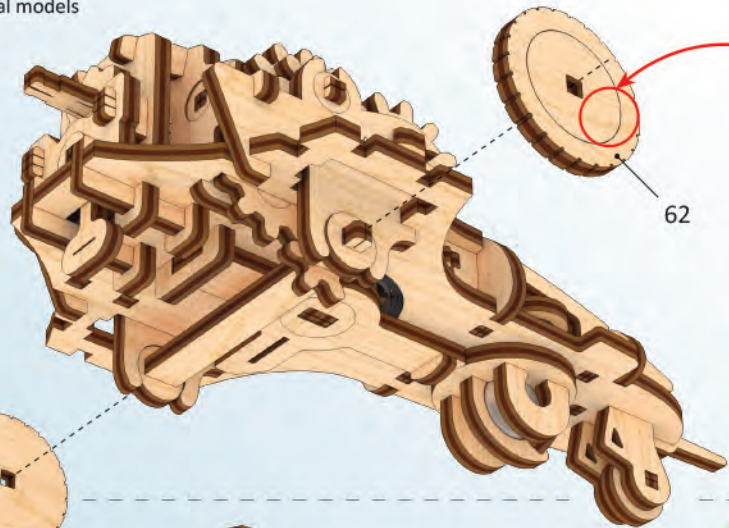

9

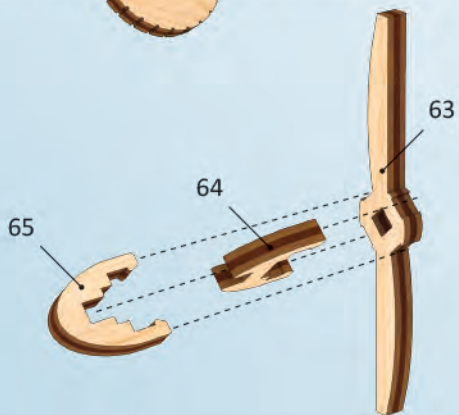

10

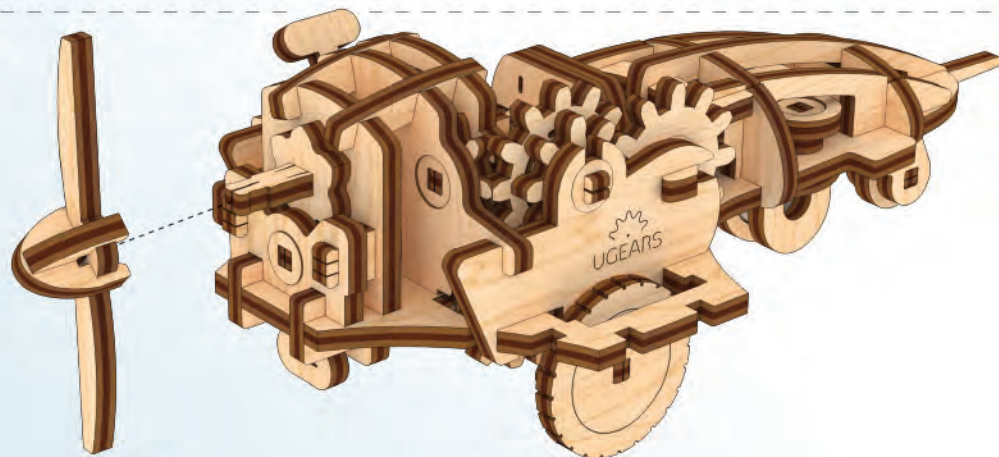

11

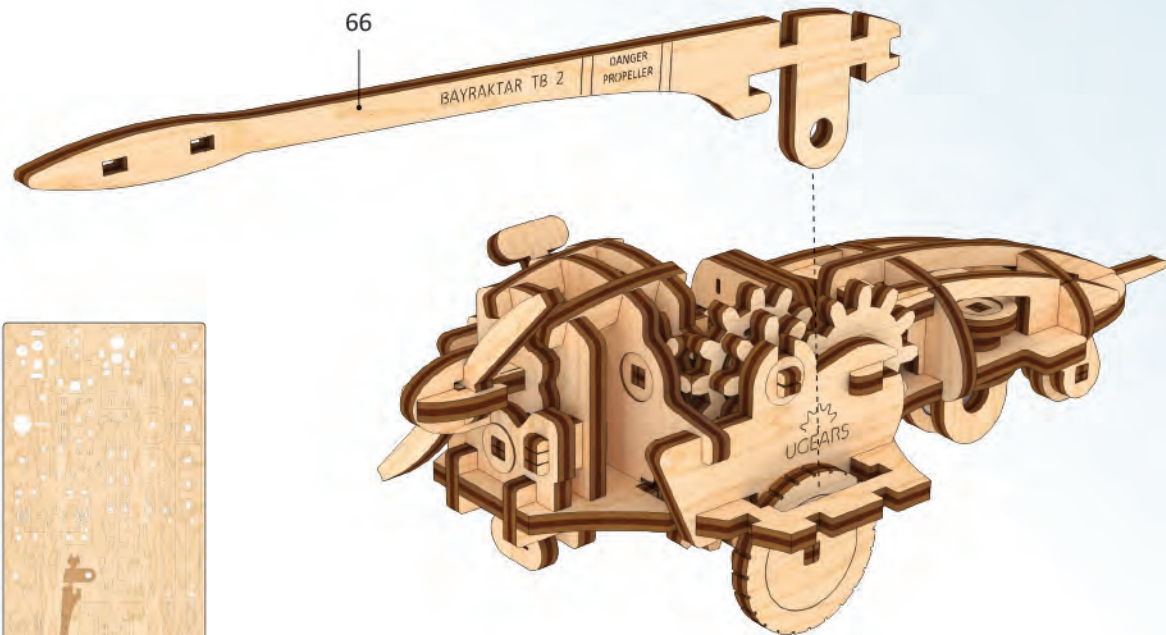

②

12

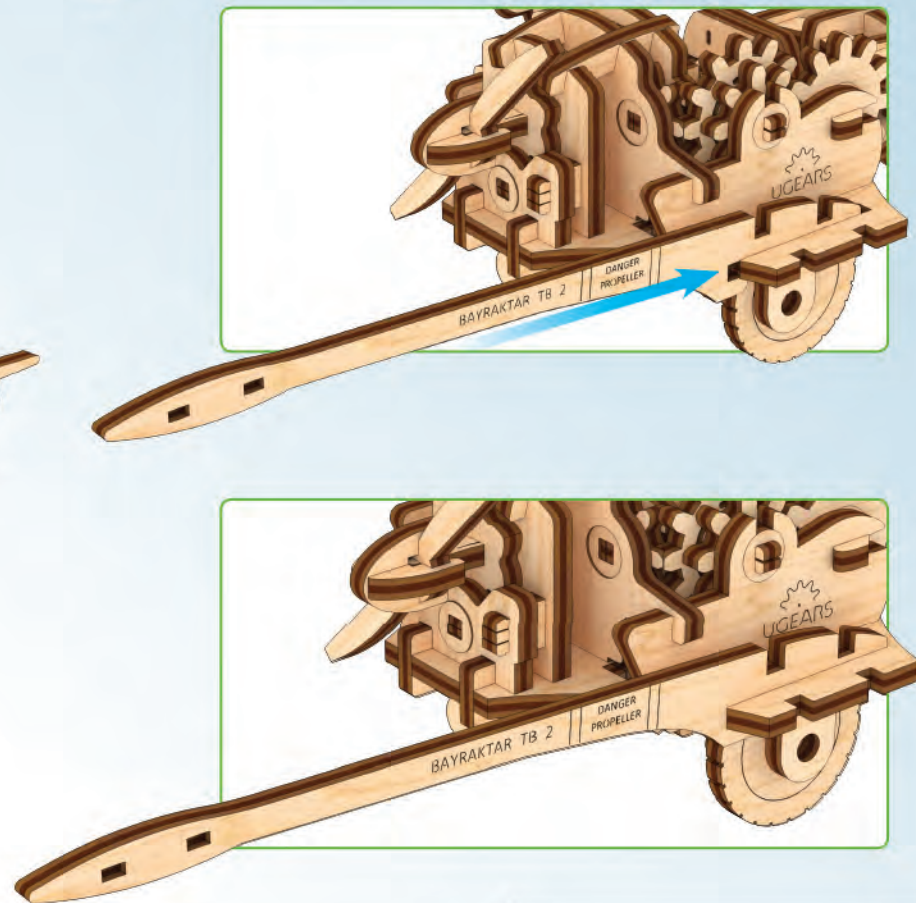

13



2

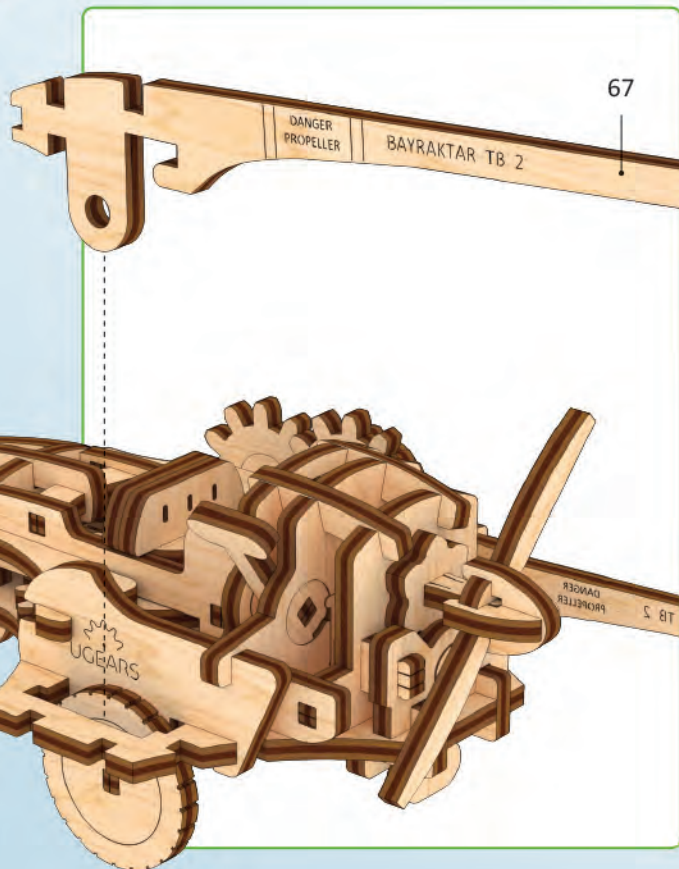

14

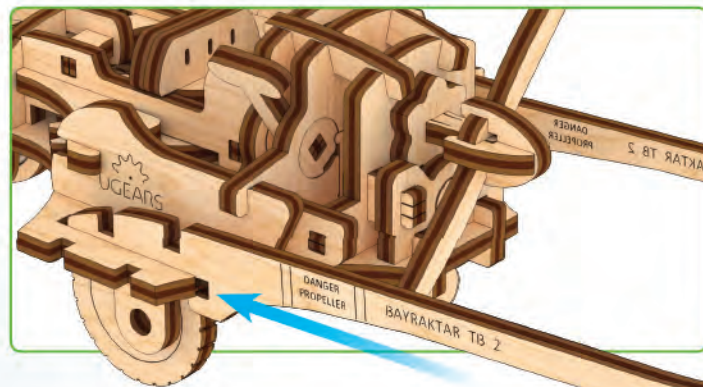

F

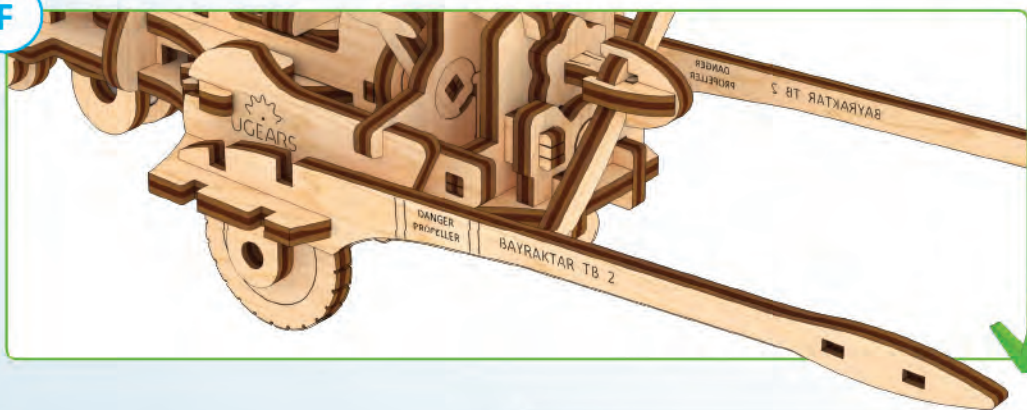

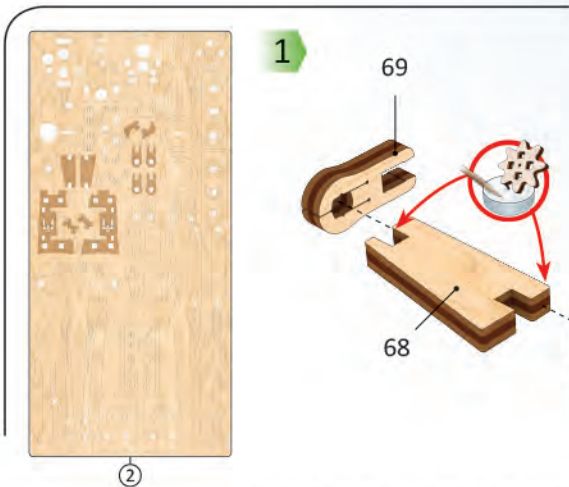

1

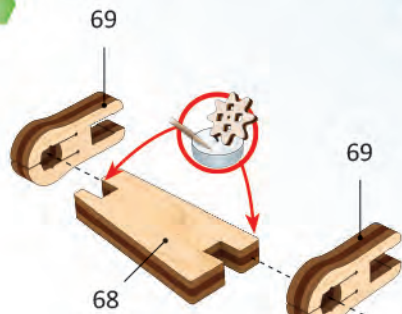

2

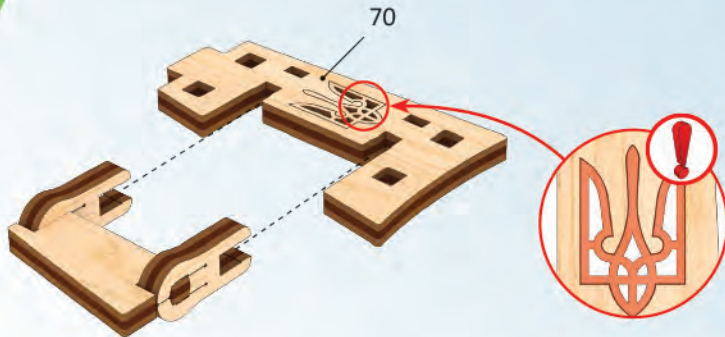

3

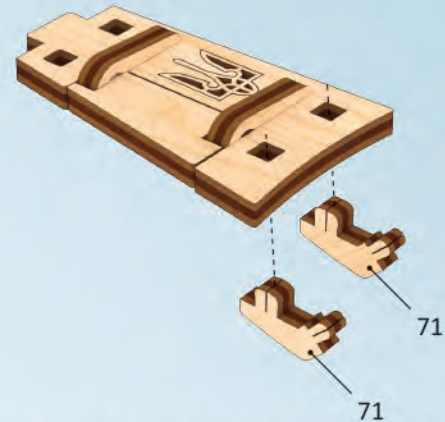

4

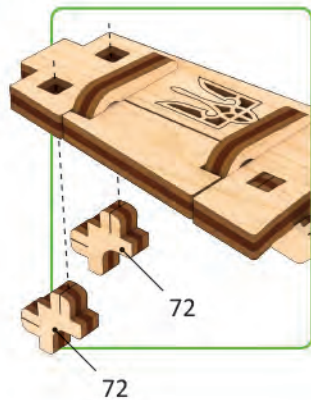

g1

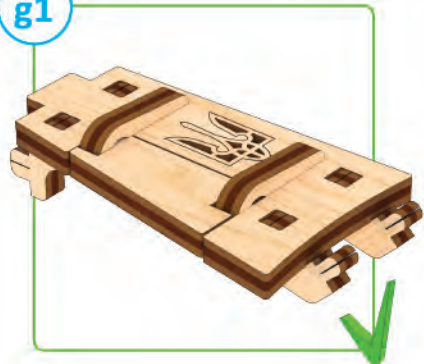

1

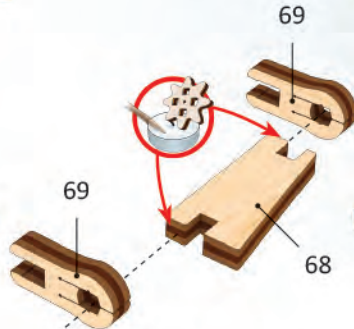

2

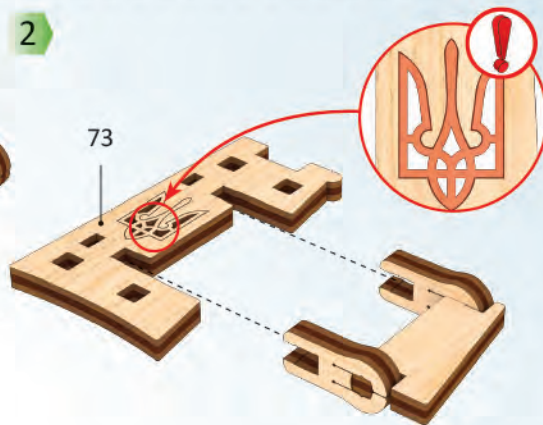

g2



1



2

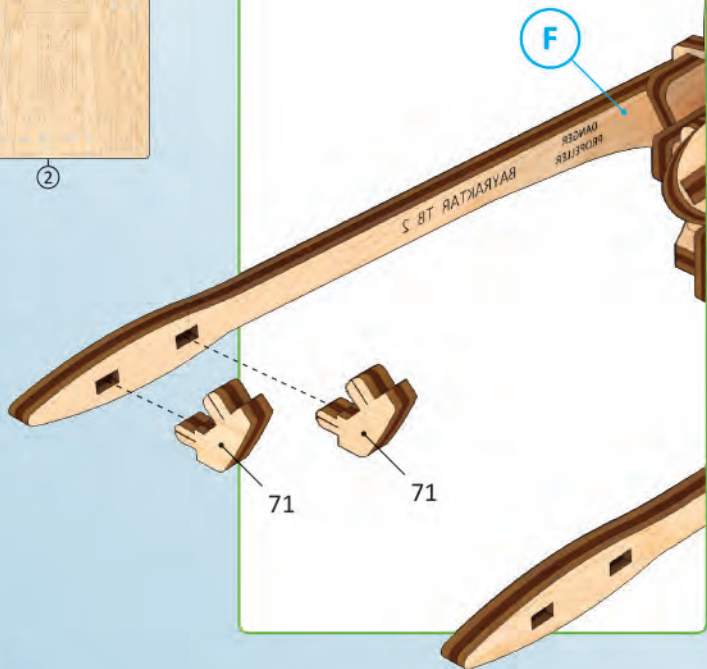

71

71

2

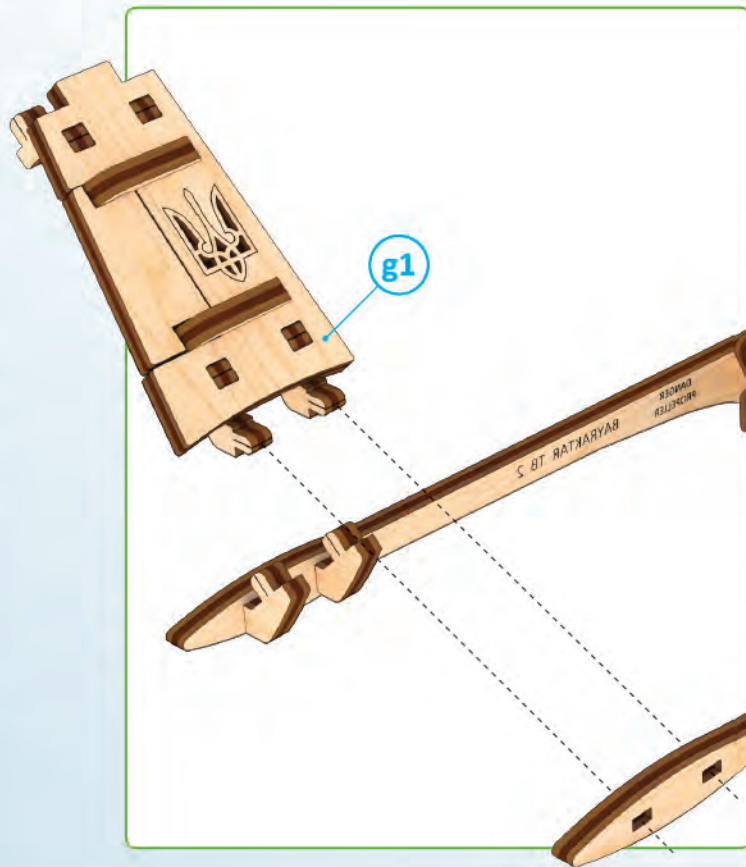

g1

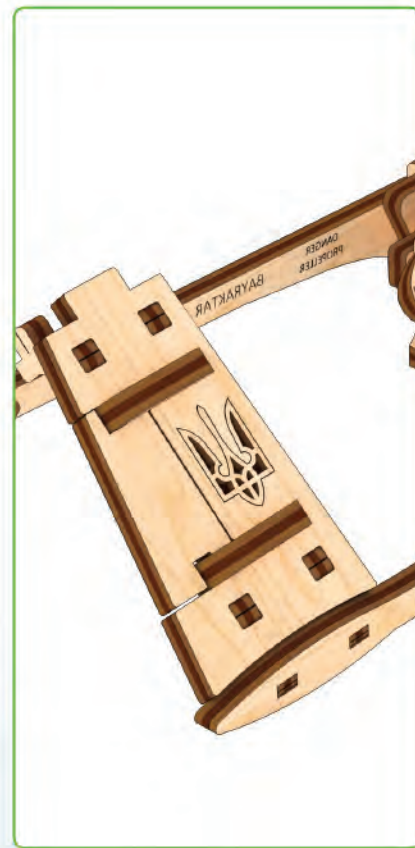

3

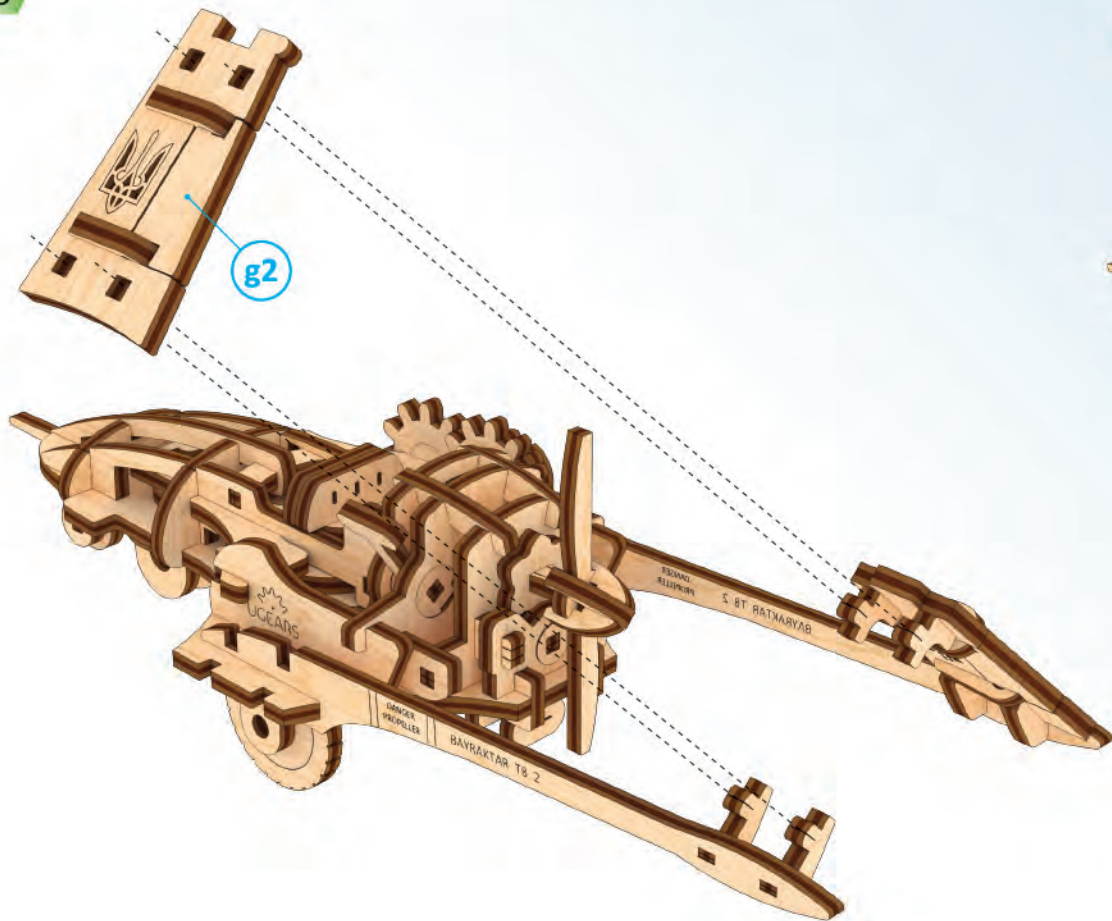

G

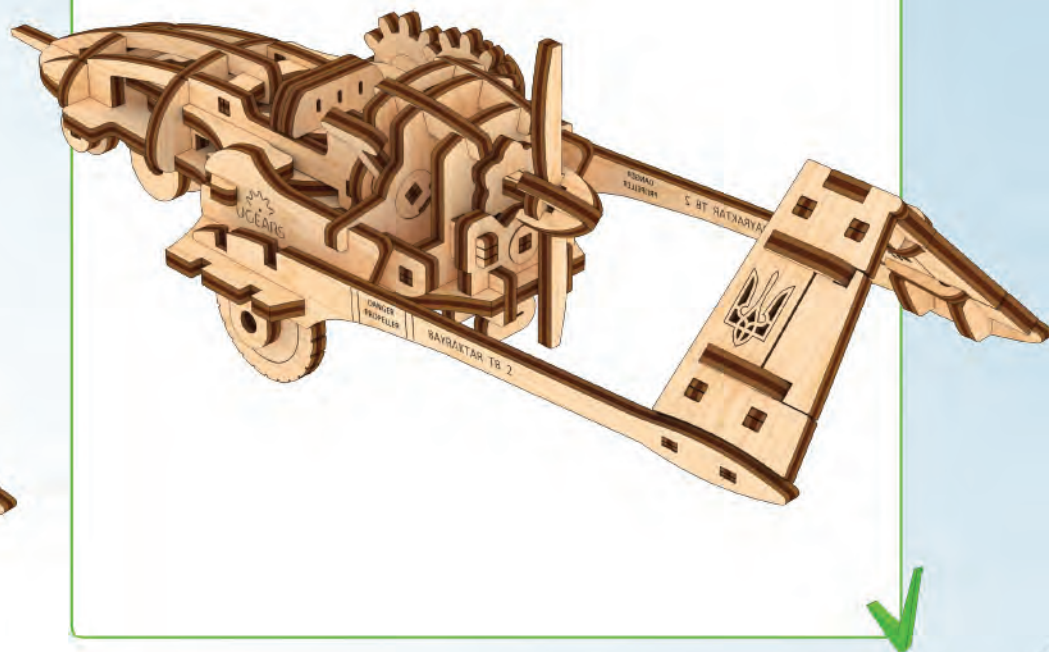



1

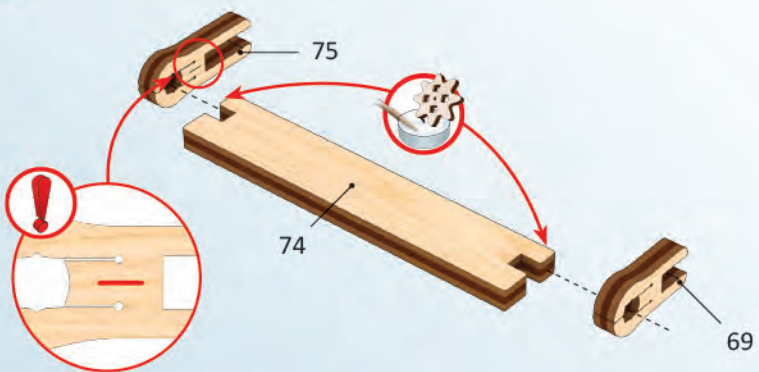

2

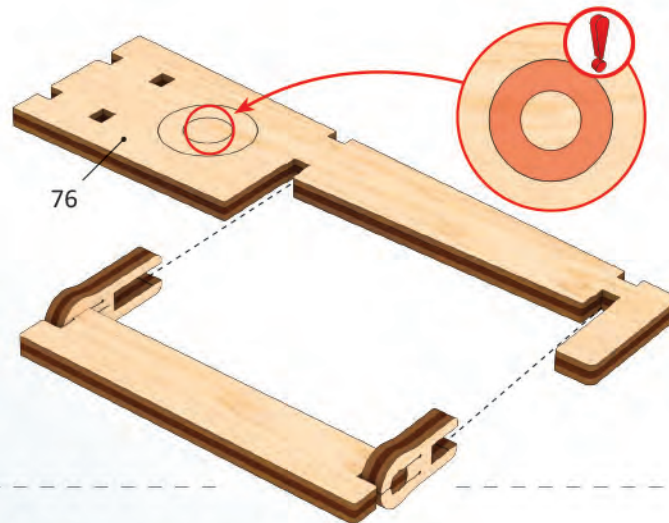

3

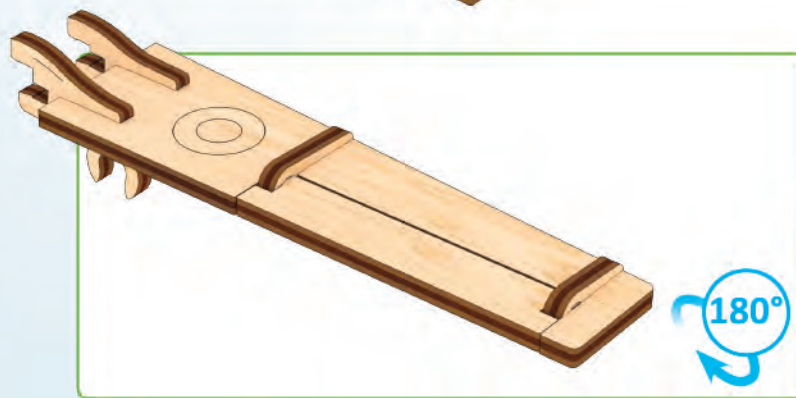
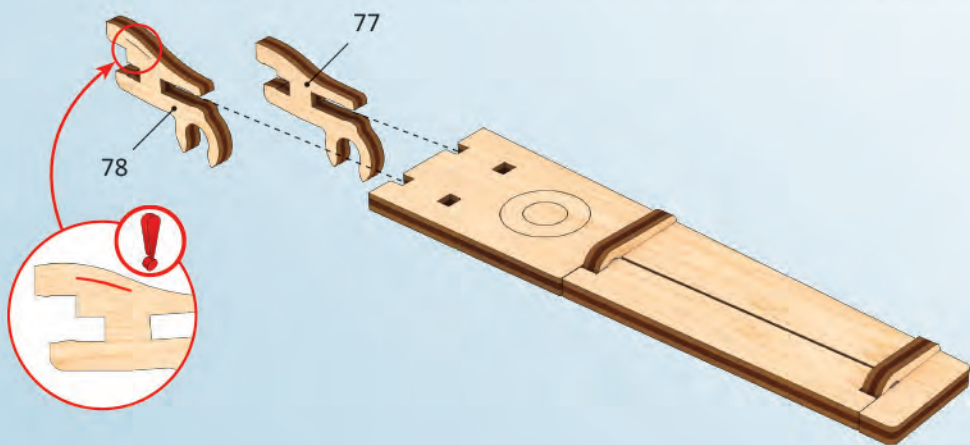



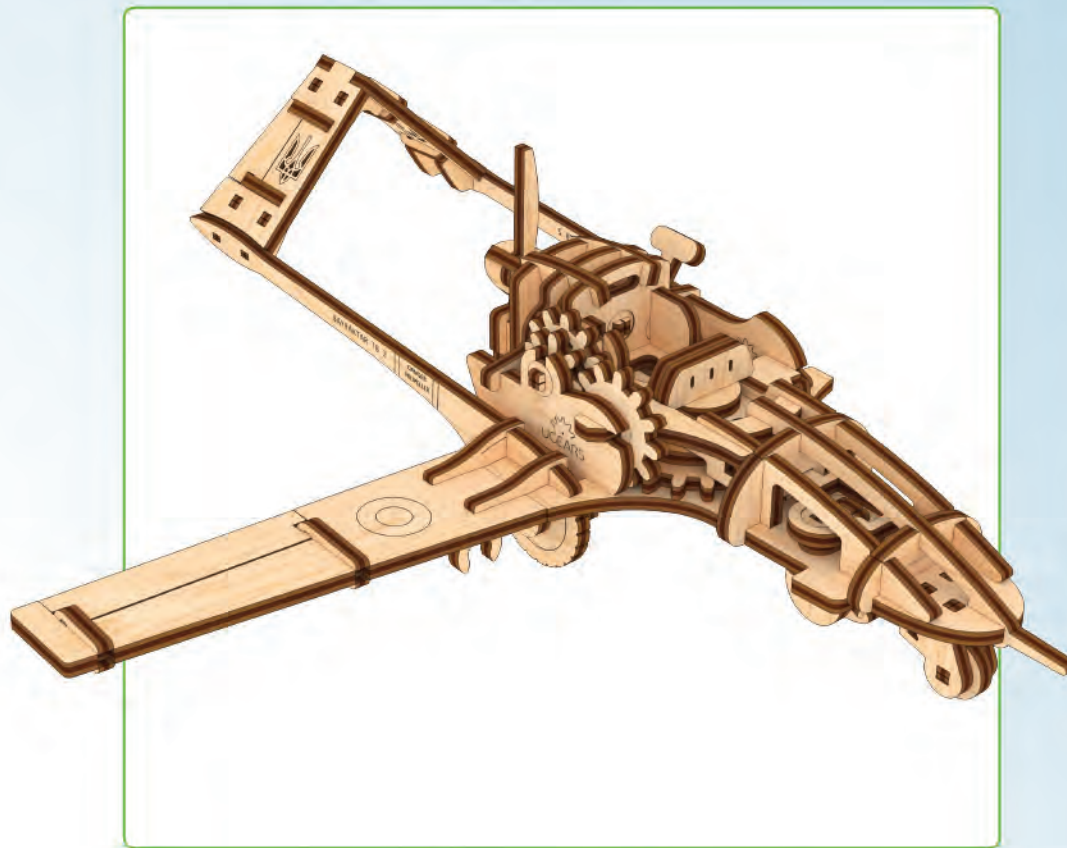
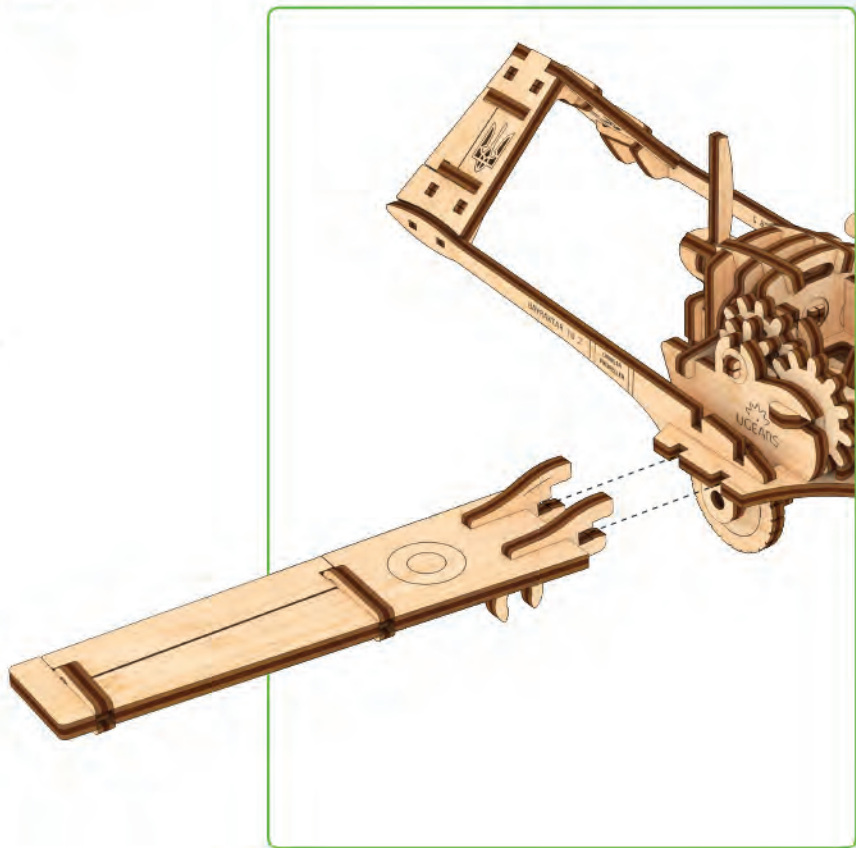

5



2

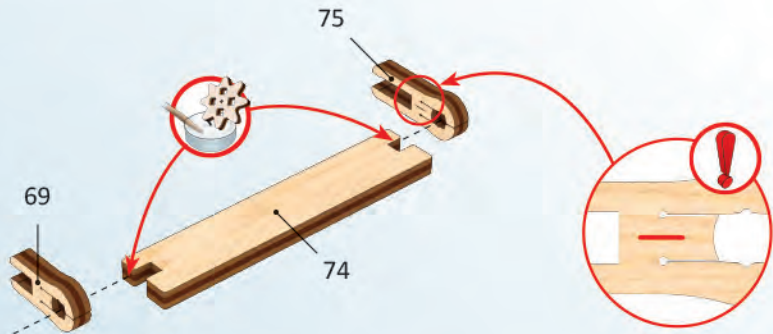

6

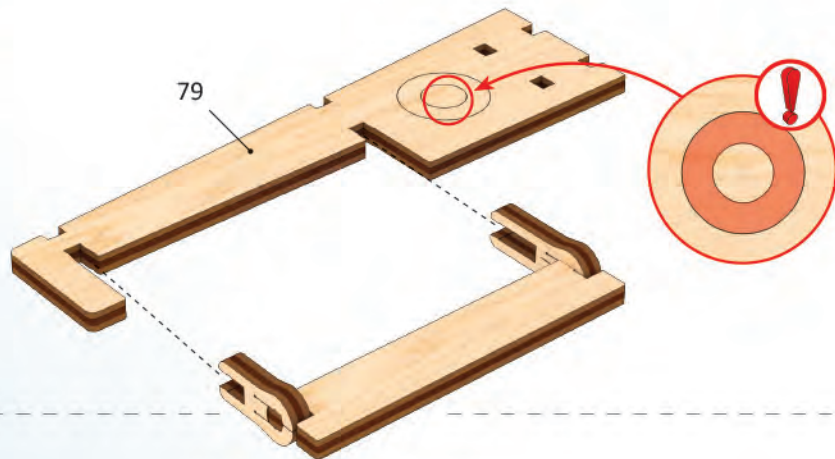

6

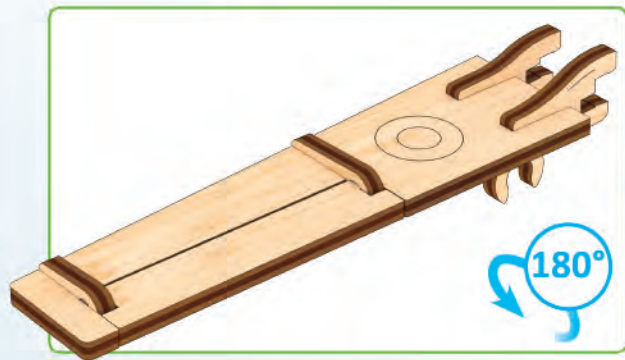
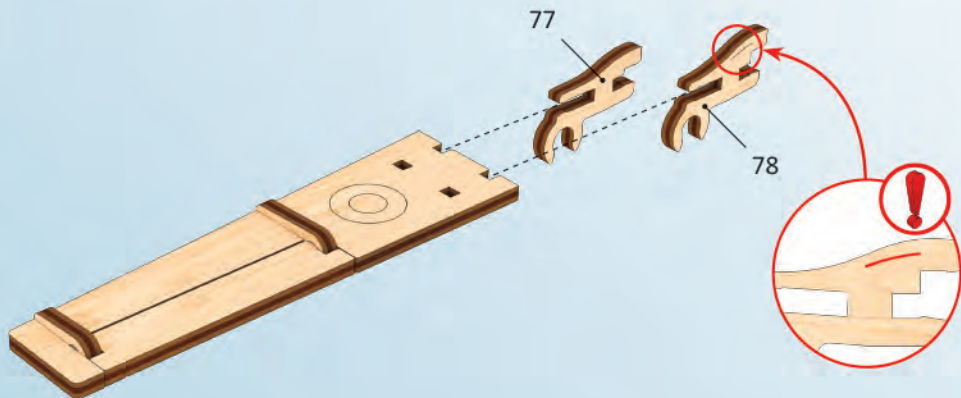

7

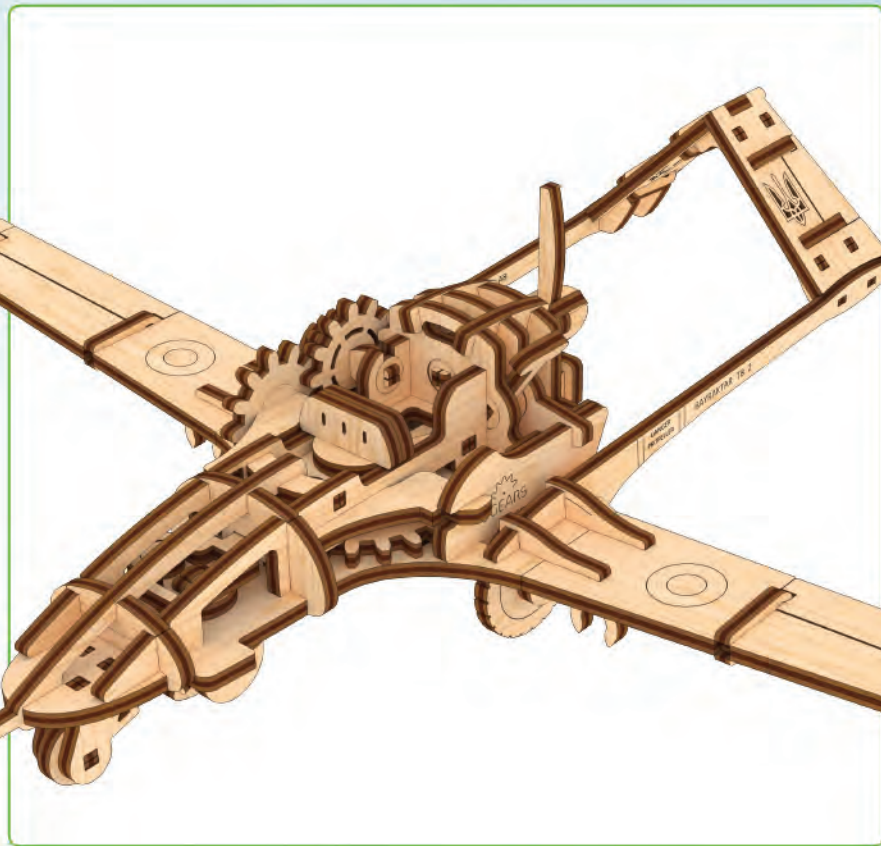
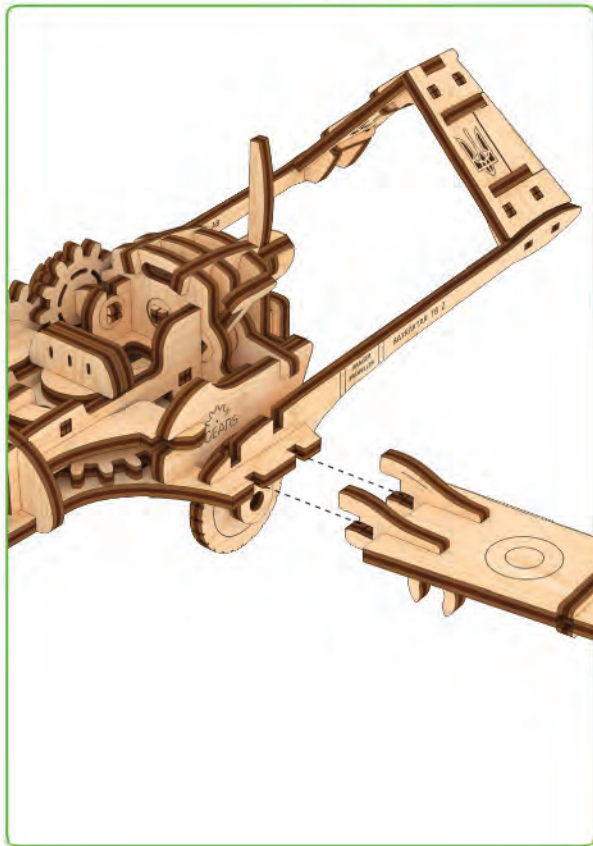

8

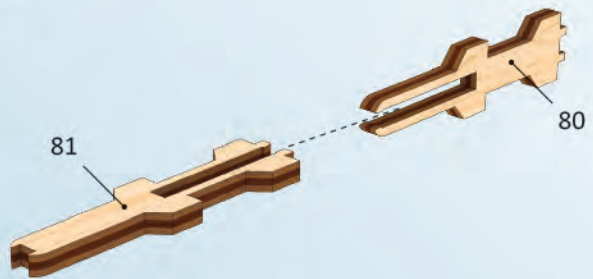

2

x2

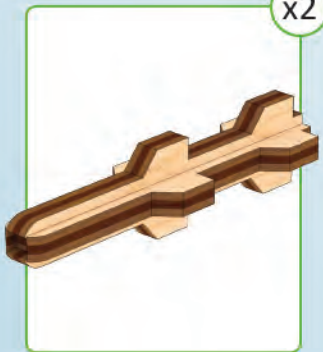

36

9

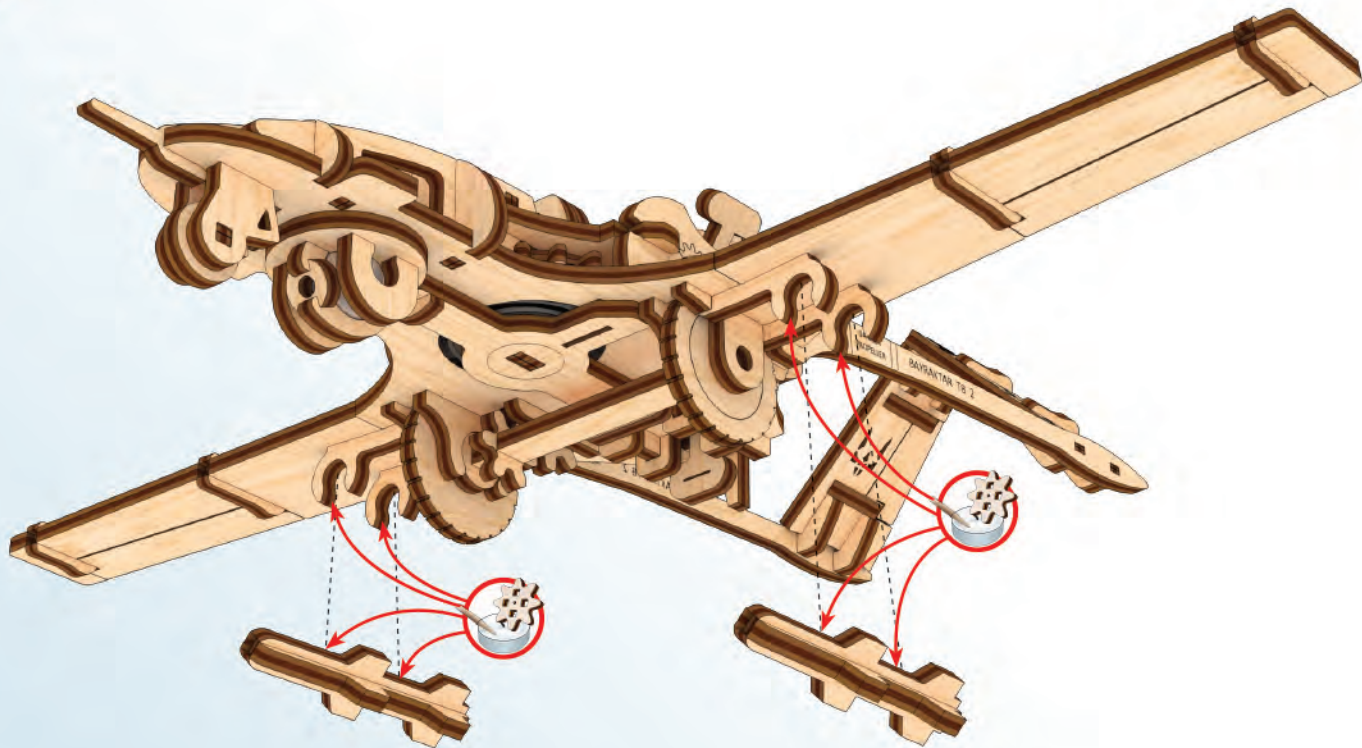

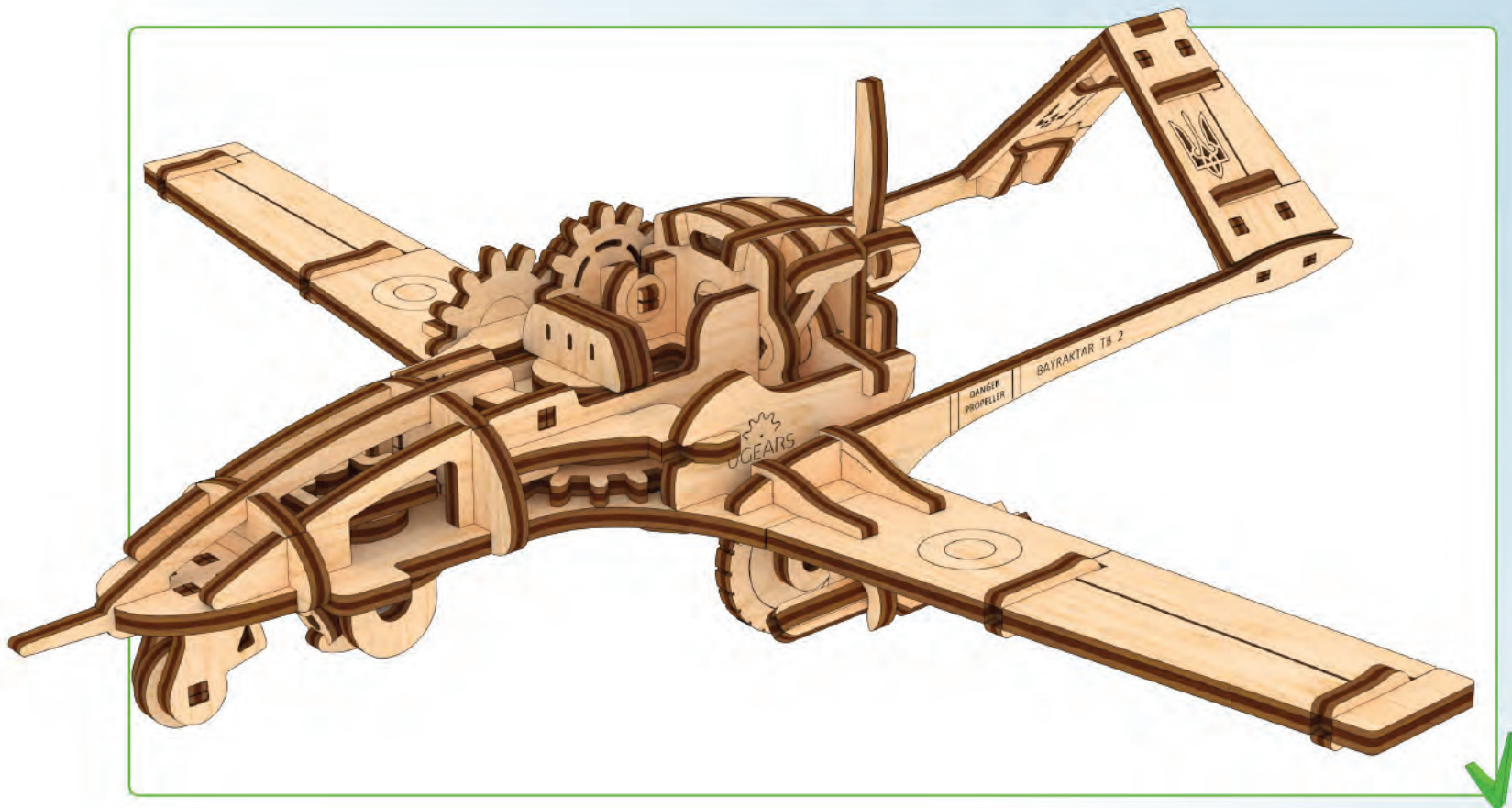

1

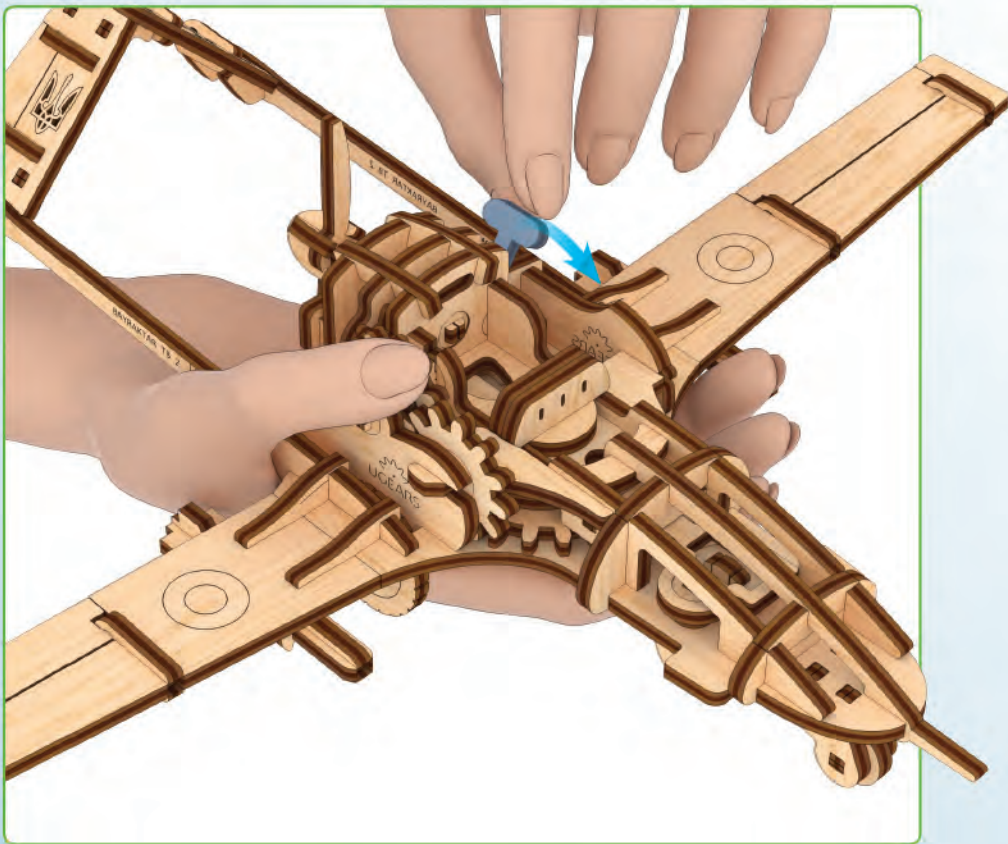

2

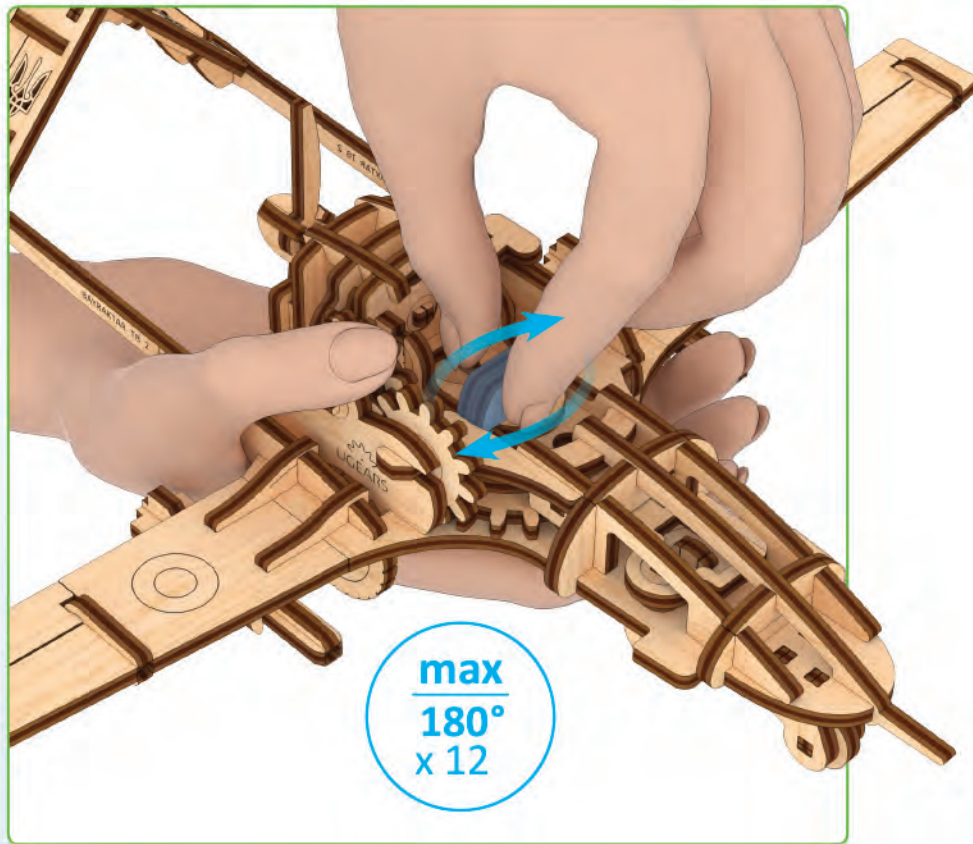

3

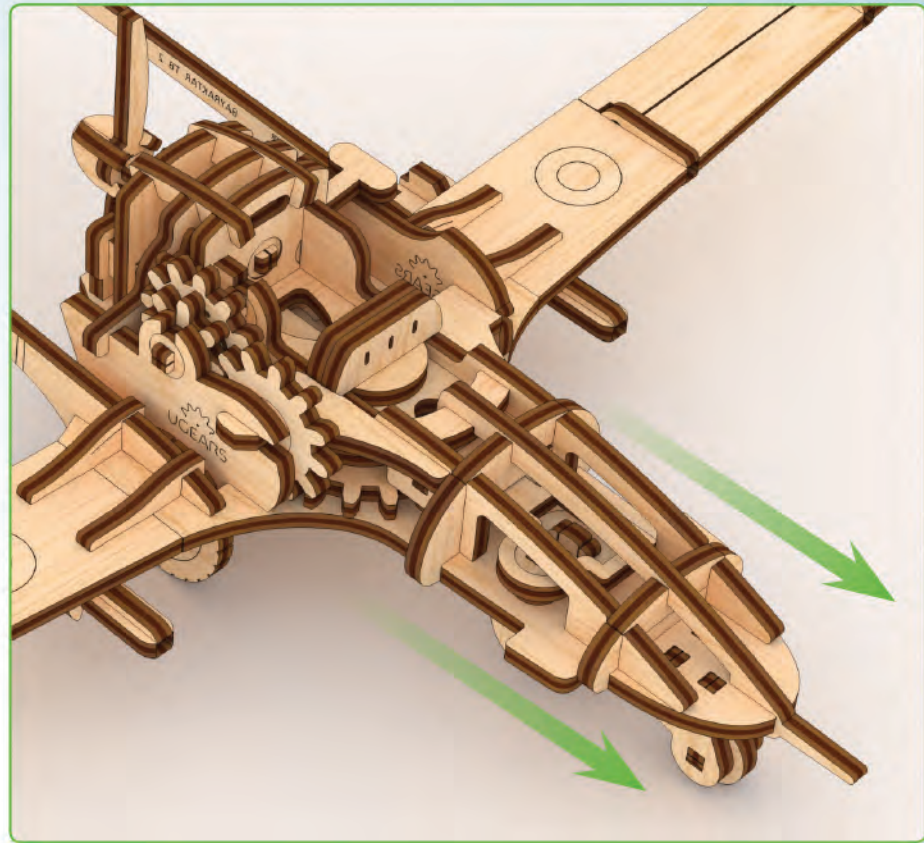
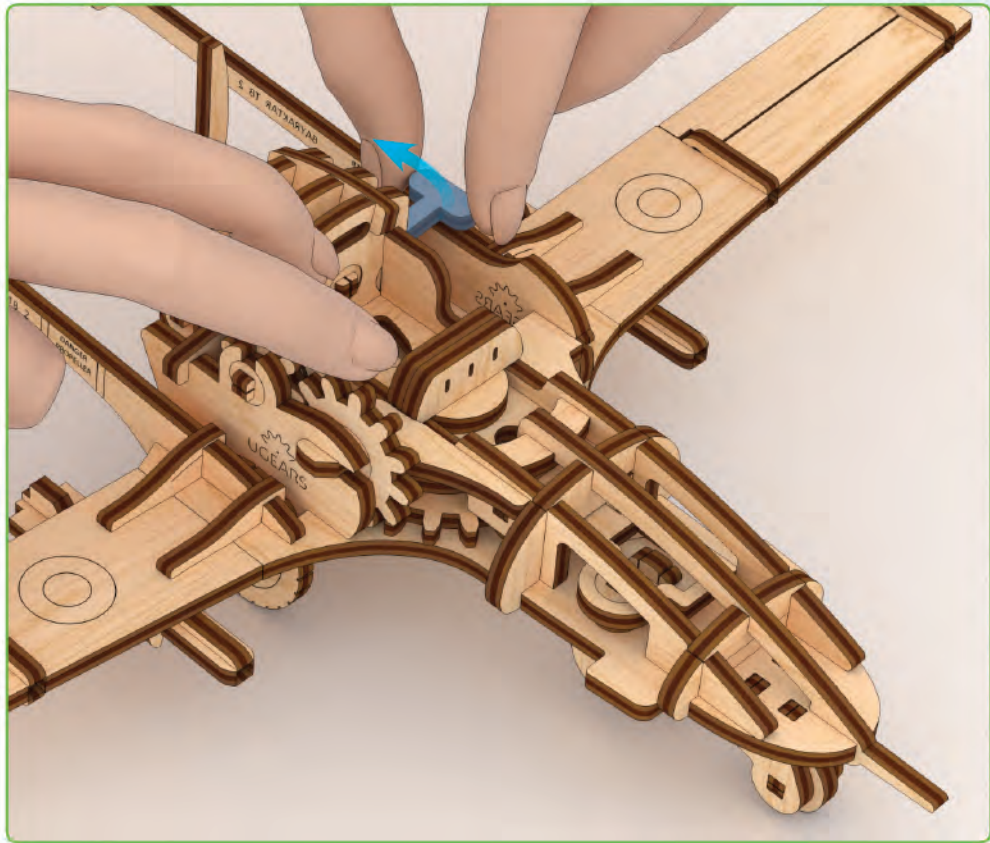



Mechanical models

**ENG** Thanks for following along on this journey with us.

**UKR** Дякуємо, що ви пройшли цей шлях з нами.

**FRA** Merci denous avoir accompagnés tout au long de ces étapes.

**DEU** Vielen Dank, dass Sie diesen Weg mit uns gegangen sind.

**SPA** Gracias por haber recorrido el camino con nosotros.

**ITA** Grazie per aver fatto uesto percorso con noi.

**JPN** UGEARSをご利用いただきありがとうございます

**CHI** 感谢您参与有趣的模型配装过程。

**TUR** Bu yolculukta bizimle birlikte olduğunuz için teşekkür ederiz.

**POL** Dziękujemy, że razem z nami pokonałeś tę drogę!

**KOR** UGEARS 와 함께해 주셔서 감사합니다.

[ugearsmodels.com](http://ugearsmodels.com)

**ENG** Customer support **UKR** Служба підтримки

**FRA** Service client **DEU** Kundendienst

**SPA** Servicio al cliente **ITA** Servizio di supporto

**JPN** お客様窓口 **CHI** 客户支持

**TUR** Müşteri desteği

**POL** Wsparcie klienta **KOR** 고객지원

[customerservice@ugearsmodels.com](mailto:customerservice@ugearsmodels.com)