

Assemble Me

Model «Royal Carriage» Модель «Королівська карета»

DEU Modell «Königliche Kutsche». FRA Modèle «Carrosse Royal».
POL Model «Królewska karetka». SPA Modelo «Carruaje real».
ITA Modello «Carrozza reale». RUS Модель «Королевская карета».
JAP ロイヤルキャリッジ. KOR 궁정마차. CHI «皇家马车».

UGEARS®
Mechanical models



Assembly instructions Інструкція зі складання

DEU Aufbauanleitung. FRA Notice d'assemblage.
POL Instrukcja montażu. SPA Instrucciones de montaje.
ITA Istruzioni di montaggio. RUS Инструкция по сборке.
JAP 組み立て説明書. KOR 조립 설명서. CHI 装配说明书.



Find out
MORE



ENG

Assembly instructions:

Remove model parts from the hanger board as illustrated below. Careful not to break parts. If a part does not remove easily, carefully cut it out with a knife. This model is intended for self-assembly without glue. If you have difficulty installing the axles, try waxing them with a regular candle. All moving parts can also be waxed during assembly to reduce friction when operating the model.

UKR

Інструкція зі складання:

Витягніть з дошки позначені на схемі деталі. Намагайтеся їх не зламати. Якщо деталь не виймається, надсічіть перемички ножом. Конструкція збирається без клею. У разі виникнення труднощів з протягуванням зубчистки (вісі) в отвір, потріть зубчистку об звичайну свічку. Також можна змастити свічкою всі деталі механізму, що рухаються, щоб зменшити тертя при обертанні.

DEU

Aufbauanleitung:

Bitte die in der Zeichnung angegebenen Teile aus der Platte herausnehmen. Versuchen Sie bitte diese nicht zu brechen. Wenn sich ein Teil nicht herausnehmen lässt, schneiden Sie die Stege mit dem Messer leicht an. Das Modell wird ohne Klebstoffe zusammengebaut. Lässt sich eine Achse nur schwer in eine Öffnung einführen, reiben Sie diese mit einer Kerze etwas ein. Für besseres Gleiten schmieren Sie alle beweglichen Teile mit einer Kerze.

FRA

Notice d'assemblage:

Faites sortir de la planche les pièces comme indiquées sur le schéma. Tâchez de ne pas les casser. Si la pièce ne sort pas, incisez les collages/fixations avec un couteau. La construction est à assembler sans colle. Si il est difficile d'introduire l'axe en bois dans l'orifice, frottez au préalable l'axe ou les pièces contre une bougie. Pour améliorer le glissement, traitez les pièces de frottement mobiles du mécanisme avec une bougie au cours d'assemblage.

POL

Instrukcja montażu:

Delikatnie wyciągaj z deseczki wskazane w schemacie detale, starając się nie połamać elementów. Jeśli detal nie poddaje się, podetnij wiązadła nożem. Konstrukcję składa się bez kleju. Jeśli napotkasz trudności z instalacją drewnianej osi w otwór,ce, potrzyj na początku oś lub detale woskową świecę. Dla lepszego poślizgu polecano smarowanie ruchomych części mechanizmu zwykłą świecą podczas montażu.

SPA

Instrucciones de montaje:

Saque de la tabla las piezas marcadas en el esquema. Trate de no romperlas. Si una pieza no se saca, haga una incisión. La construcción va sin pegamento. Si tiene dificultades con la instalación del eje de madera en un agujero, frote primero el eje o las piezas contra una vela. Para un mejor deslizamiento, lubrique durante el montaje las piezas móviles del mecanismo con una vela común.

ITA

Istruzioni di montaggio:

Estrarre dal telaio i particolari indicati nello schema. Fare attenzione a non romperli. Se un particolare non si stacca, tagliare delicatamente gli elementi di collegamento con un coltello. L'assieme viene realizzato senza colla. In caso di difficoltà nell'inserimento di un perno in legno, è necessario sfregare il perno o il particolare con un po' di cera. Per uno scorrimento migliore inceperare le parti mobili del meccanismo durante l'assemblaggio.

RUS

Инструкция по сборке:

Внимайте из доски обозначенные на схеме детали. Старайтесь их не ломать. Если деталь не извлекается, надрежьте перемички ножом. Конструкция собирается без клея. Если возникли трудности с установкой деревянной оси, перед установкой потрите детали об обычную свечу. Для лучшего скольжения смазывайте движущиеся детали механизма обычной свечой во время сборки.

JAP

組み立て説明書:

部品に傷をつけないように注意しながらボードから外してください。部品が外れにくい場合は連結部分をカッターで切ってから外すと外しやすいです。本製品は、接着剤がなくても組み立てができるように設計されています。もしアクスル(駆動部)が、歯車の動きがにびい場合は、口ワソクをアクスルに塗ってください。全ての駆動部分は製品を動かす時、滑らかに動くように潤滑剤である口ワソクを塗りながら組み立てます。

KOR

조립 설명:

부품이 손상되지 않도록 주의하여 보드에서 떼어냅니다. 만약 부품이 잘 떨어지지 않으면 연결 부분을 칼로 절단 한 후 떼어내면 쉽게 떼어 낼 수 있습니다. 본 제품은 접착제가 없이 조립이 가능하도록 설계되어 있습니다. 만약 축이 잘 끼워지지 않는 경우 양초를 축에 바른 후 끼워 보세요. 모든 구동 부위는 제품 구동 시 원활한 작동이 가능하도록 조립 과정에서 윤활제(양초)양초를 발라 주세요.

CHI

装配说明:

将模型部件按插图示,从胶合板取下。小心不要损坏零件。如果取下时具有难度,请用用小刀小心地切割连接点。这个产品不需要胶水粘接。如果安装转轴的时候有难度,请用普通的蜡加以润滑。所有的转动部分也需要打蜡润滑。

ENG Warning! UKR Увага! DEU Achtung! FRA Attention! POL Uwaga! SPA Precaución! ITA Attenzione! RUS Внимание! JAP 注意! KOR 주의! CHI 注意!



ENG Do not use a lighted candle! UKR Не підпалювати! DEU Nicht anzünden! FRA Ne pas brûler! POL Nie podpalac! SPA ¡No encender! ITA Non dare fuoco! RUS Не поджигать! JAP 火のついた口ワソクの使用はお止めください。 KOR 불이 붙은 초를 이용하지 마세요! CHI 请勿点燃, 请勿靠近火源!



ENG Caution! Axles have sharp points! UKR Обережно! Гострі деталі! DEU Vorsicht! Spitze Teile! FRA Attention: certaines pièces sont pointues! POL Ostrożnie! Ostre części! SPA ¡Atención! Piezas afiladas! ITA Attenzione! Particolari appuntiti! RUS Осторожно! Острые детали! JAP アクスル(駆動部)の鋭い部分にご注意ください。 KOR 축의 뾰족한 부분에 주의하세요! 注意! CHI 舌尖锐部件!

ENG Customer support **UKR** Служба підтримки **DEU** Kundendienst **FRA** Service client **POL** Wsparcie klienta

SPA Servicio al cliente **ITA** Servizio di supporto **RUS** Служба поддержки **JAP** お客様窓口 **KOR** 고객센터 **CHI** 客户支持

customerservice@ugearsmodels.com

ENG Symbols. UKR Умовні позначення. DEU Legende. FRA Légende. POL Oznaczenia umowne. SPA Leyenda.
ITA Legenda. RUS Условные обозначения. JAP 記号 KOR 기호. CHI 图标含义.



ENG Wax the part with a regular candle (rub with a candle). UKR Змастіть деталь звичайною свічкою (потріть об свічку).
DEU Reiben Sie das Teil mit einer einfachen Kerze etwas ein. FRA Lubrifiez la pièce avec une bougie ordinaire (frottez contre la bougie).
POL Przesmaruj wytykłą świecą. SPA Engrase la pieza con una vela común (frote con una vela). ITA Incerare il componente (Sfregare con la cera).
RUS Смажьте деталь обычной свечкой (потрите о свечку). JAP 表示された部分に潤滑剤としてロウソクを塗ってください。
KOR 표시된 부분에 윤활을 위해 초를 칠해 주세요. CHI 用普通蜡烛涂抹润滑部件。



ENG Pay attention. Check for correct orientation or positioning. UKR Зверніть увагу. Перевірте розташування елемента.
DEU Bitte Beachten. Prüfen Sie die Einbaulage des Elementes. FRA Faites attention. Vérifiez la disposition de l'élément.
POL Zwróć uwagę. Sprawdź lokalizację elementu. SPA Atención. Compruebe la situación del elemento. ITA Prestare attenzione. Controllare la posizione del componente.
RUS Обратите внимание. Проверьте расположение элемента. JAP 方向及び位置に注意して組み立ててください。
KOR 방향 또는 위치에 주의해서 조립해 주세요. CHI 注意！检查部件方向和位置。



ENG The part should be easily rotated (moved). UKR Деталь повинна легко крутитися (рухатися). DEU Der Teil soll leicht gedreht (bewegt) werden.
FRA La pièce doit tourner (se déplacer) aisément. POL Element powinien łatwo się kręcić (poruszać się).
SPA La pieza debe ser fácil de girar (mover). ITA Il componente deve girare (muoversi) facilmente.
RUS Деталь должна легко крутиться (двигаться). JAP 部品はしっかりと動かなければなりません。
KOR 활하게 움직일 수 있어야 합니다. CHI 此部件必须容易的旋转 (移动)。



ENG Perform the same steps in mirror image. UKR Здійснити аналогічне складання у дзеркальному відображенні.
DEU Den analogen Zusammenbau in der Spiegelreflexion zu machen. FRA Procédez à l'assemblage dans le sens opposé (inverse).
POL Dokonaj analogiczny montaż w odbiciu lustrzanym. SPA Haga un ensamblaje similar en imagen especular.
ITA Realizzare lo stesso assemblaggio nell'immagine speculare. RUS Произвести аналогичную сборку в зеркальном отражении.
JAP 同じ部品を対称となるようにペアで作業してください。
KOR 동일한 부품을 대칭이 되도록 쌍으로 작업해 주세요. CHI 在镜面对称执行相同的步骤。

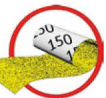

ENG Sand to remove burrs. UKR Видаліть задирки. DEU Grate entfernen. FRA Eliminez les bavures. POL Usuń zadziory.
SPA Quite las rebabas. ITA Togliere le bave. RUS Удалите заусенцы. JAP バリ取りのサンドペーパー. KOR 거친 부분을 다듬어 주세요. CHI 磨掉毛刺。



ENG Break off or cut out. UKR Відламайте або відріжте. DEU Abbrechen oder Abschneiden. FRA Coupez ou cassez.
POL Odłam lub odetnij. SPA Rompa o corte. ITA Staccare o tagliare. RUS Отломайте или отрежьте. JAP 切ってください。
KOR 잘라내 주세요. CHI 切断。



ENG Spare parts. UKR Занасні деталі. DEU Ersatzteile. FRA Pièces de rechange.
POL Części zamienne. SPA Piezas de repuesto. ITA Pezzi di ricambio. RUS Запасные детали. JAP 予備部品. KOR 여유 부품입니다. CHI 备用件。

ENG This is not a structural component; it is a tool for measurement and assembly. UKR Це не деталь конструкції, а допоміжний інструмент для складання або вимірювання відстаней.
DEU Es ist kein Teil der Konstruktion, sondern ein Hilfselement für den Zusammenbau oder für das Messen der Abstände. FRA Cette pièce ne fait pas partie de la construction mais constitue un outil annexe pour l'assemblage ou la mesure des distances.
POL To nie detal konstrukcji, a pomocnicze narzędzie dla montażu i wymiaru odległości. SPA No es una pieza de la construcción sino un instrumento auxiliar para montar o para medir distancias.
ITA Non è un componente del modello, ma un'attrezzatura aggiuntiva per il montaggio o il rilievo delle quote. RUS Это не деталь конструкции, а вспомогательный инструмент для сборки или измерения расстояний.
JAP この部品は完成時の部品ではなく、組み立てをサポートしたり測定する道具です。
KOR 이 부품은 조립을 위한 부품이 아니고 조립을 돕거나 측정을 위한 도구입니다. CHI 这不是装配零部件，是一种测量及安装辅助工具。

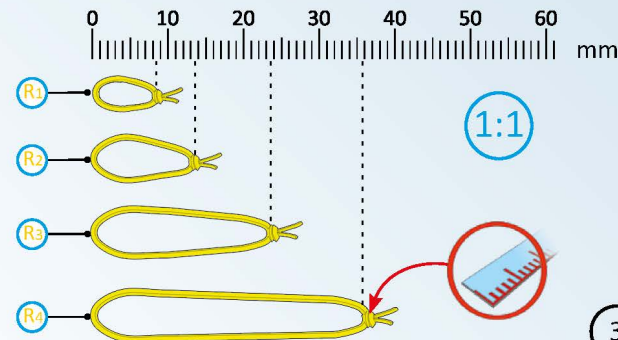

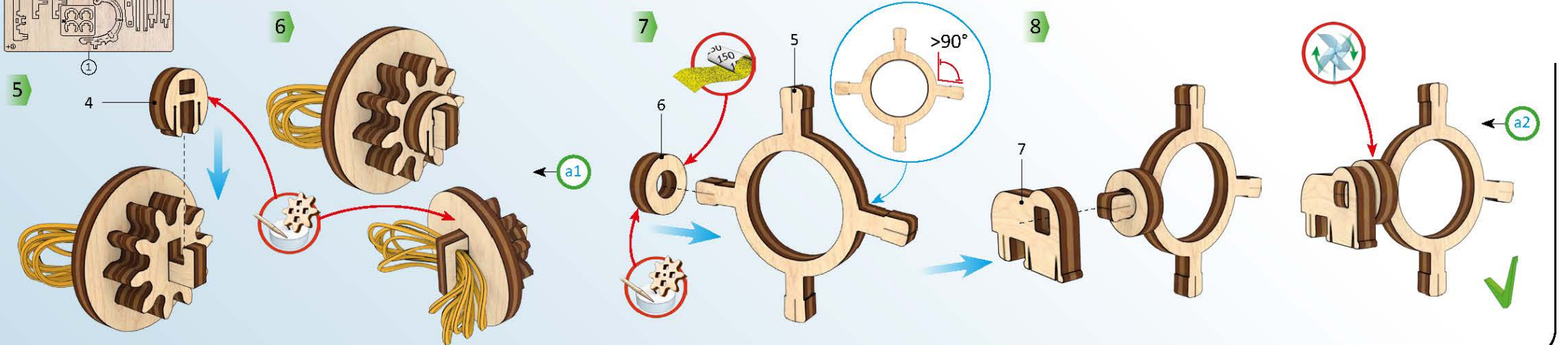
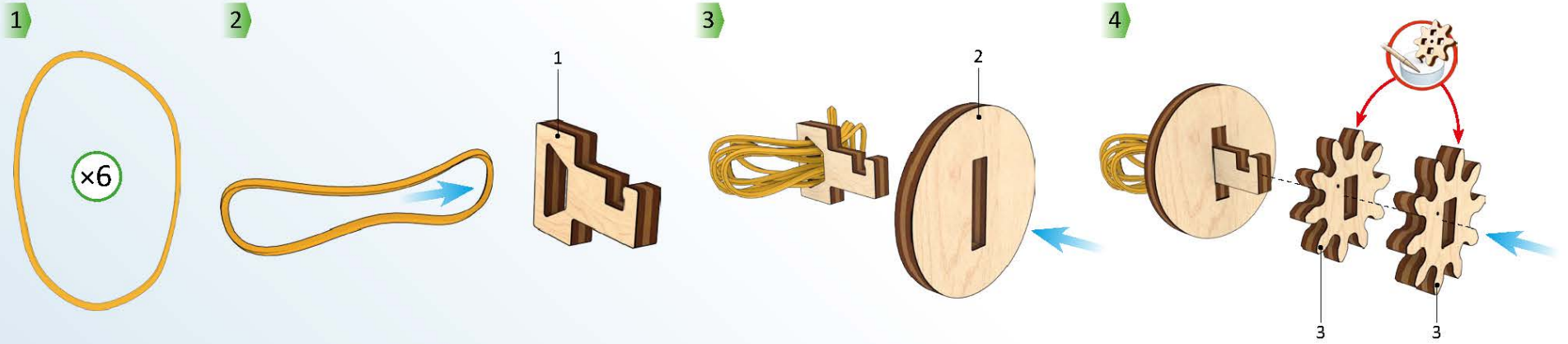
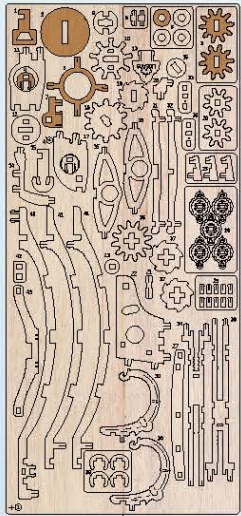

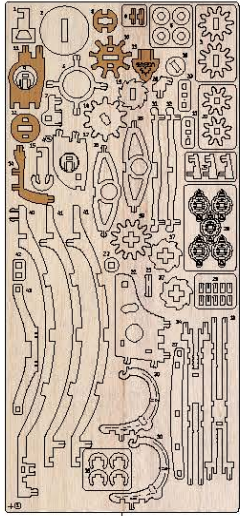

1

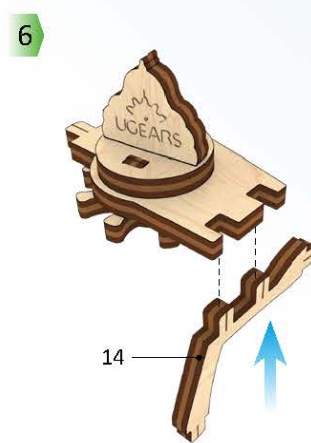
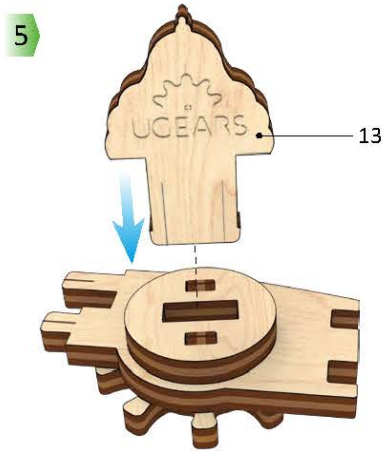
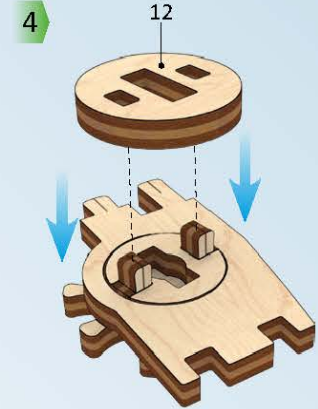
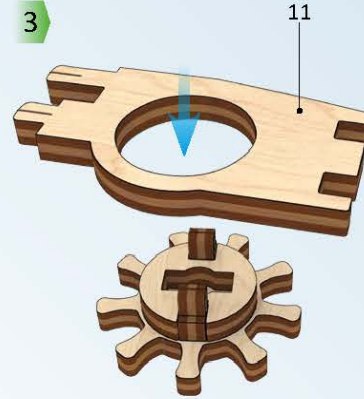
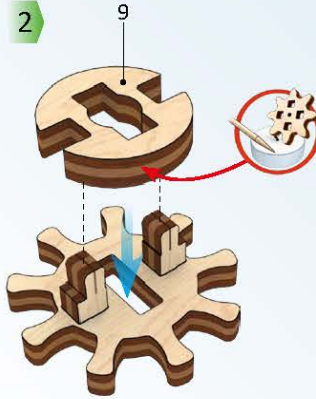
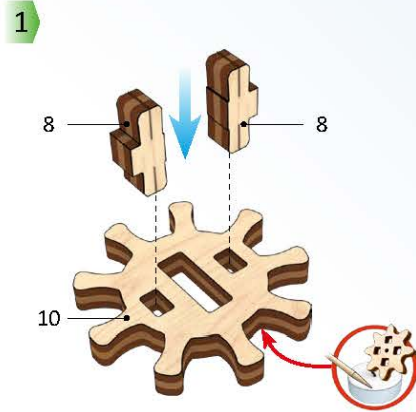

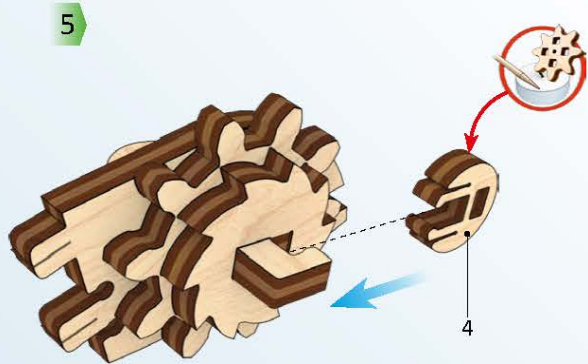
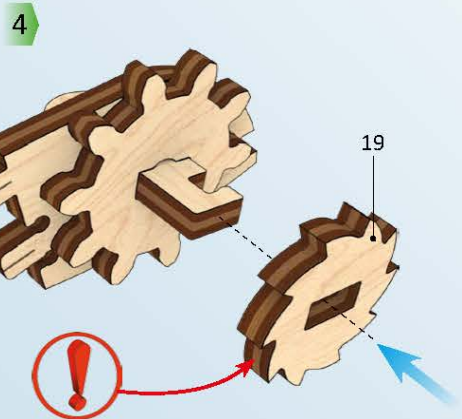
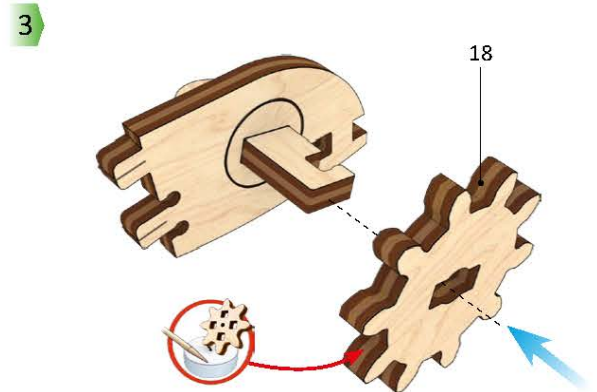
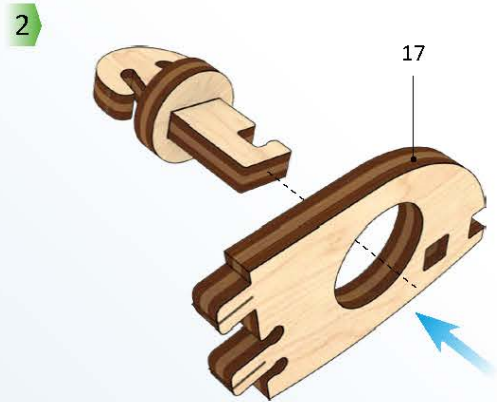
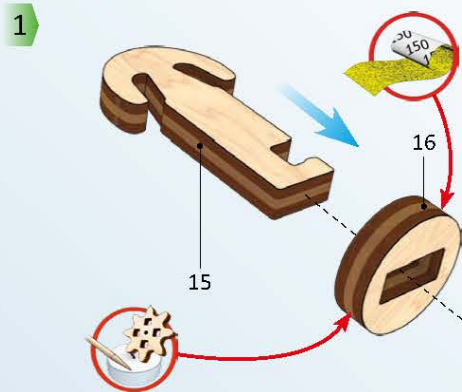
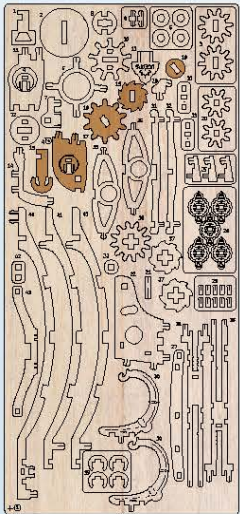

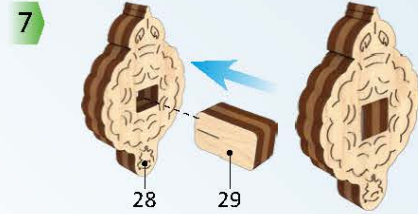
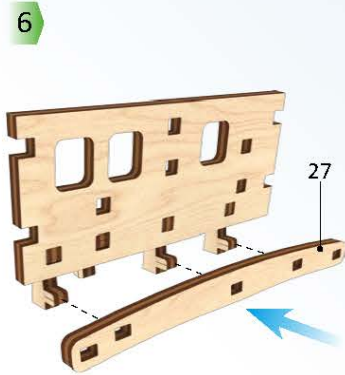
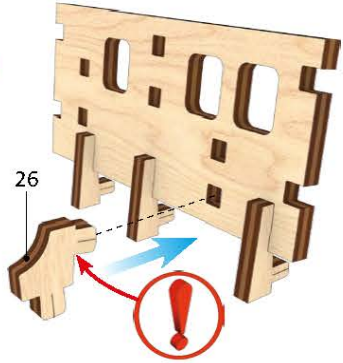
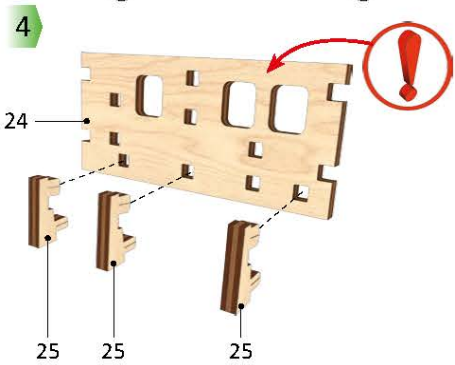
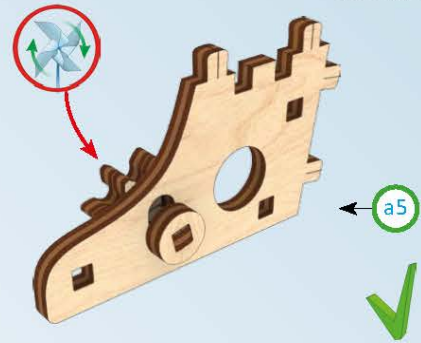
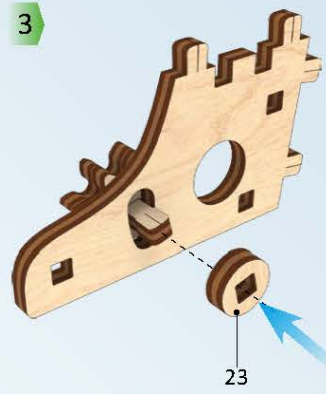
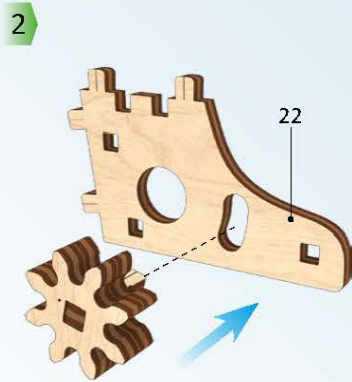
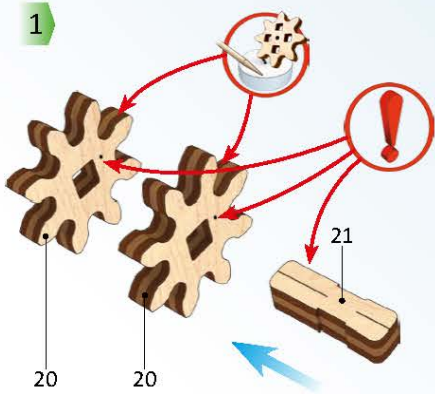
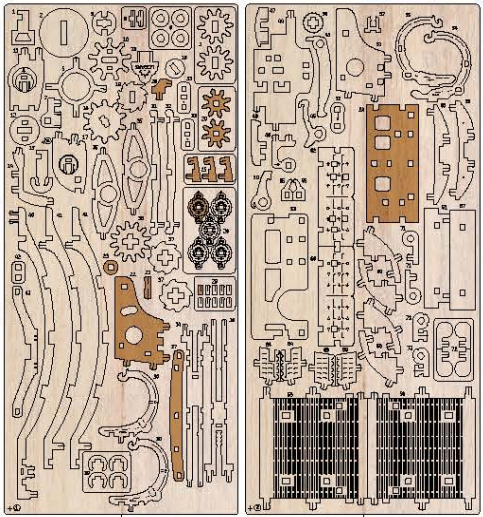

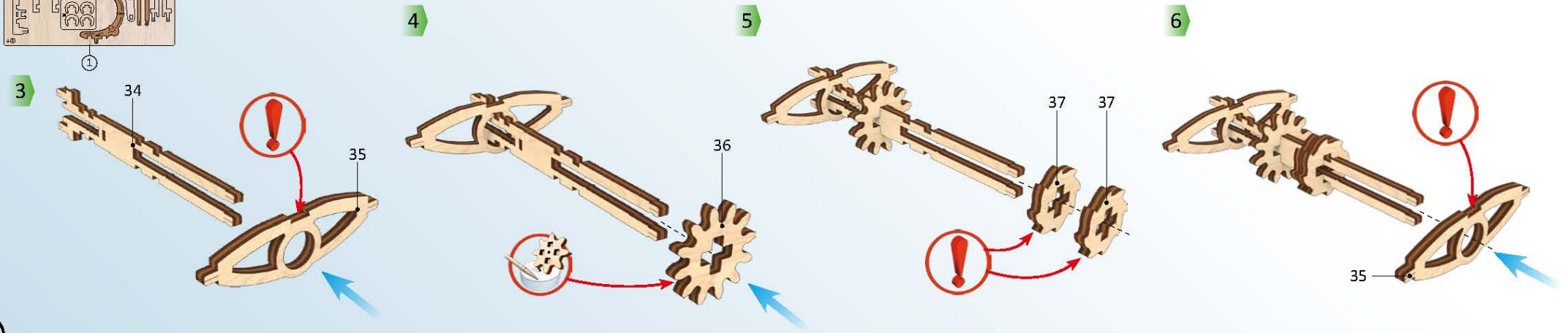
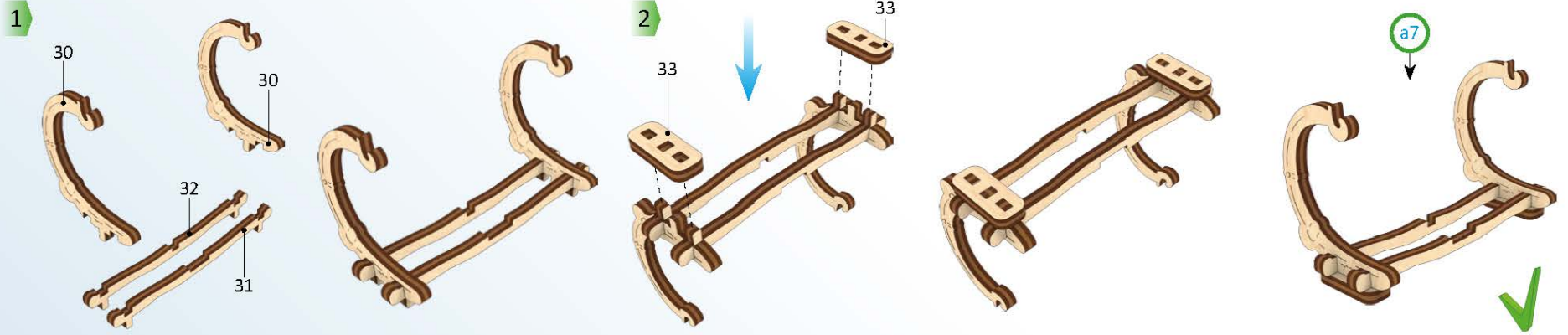
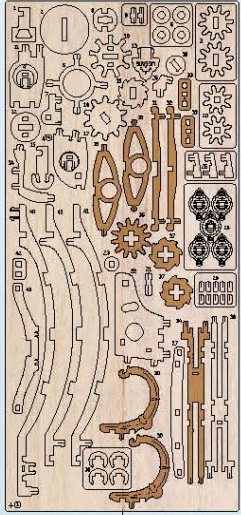

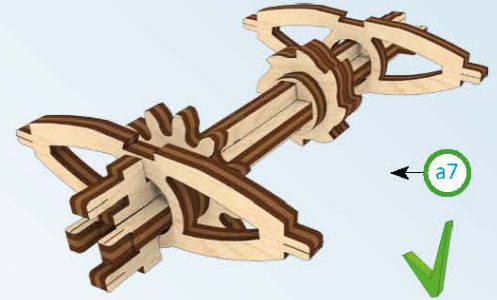
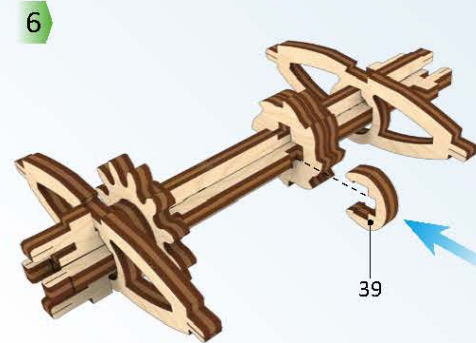
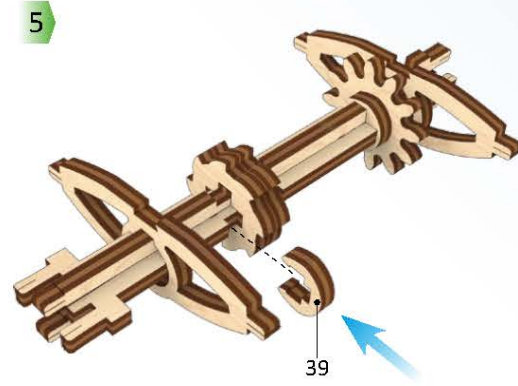
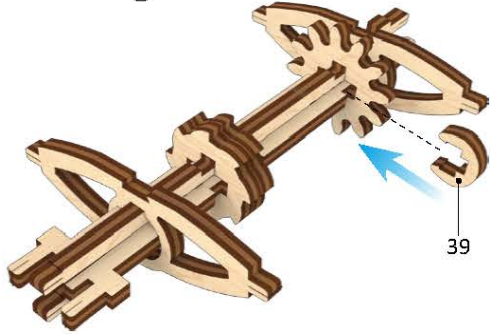
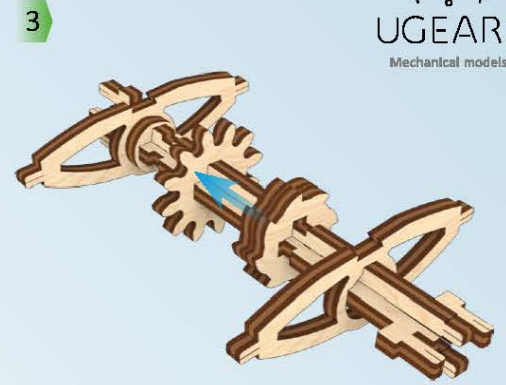
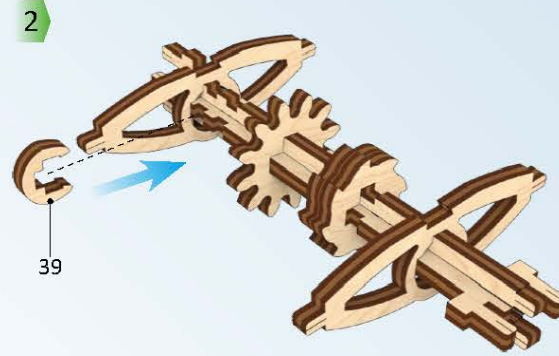
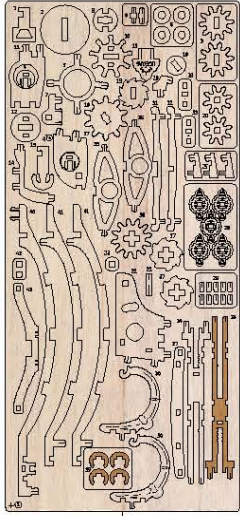

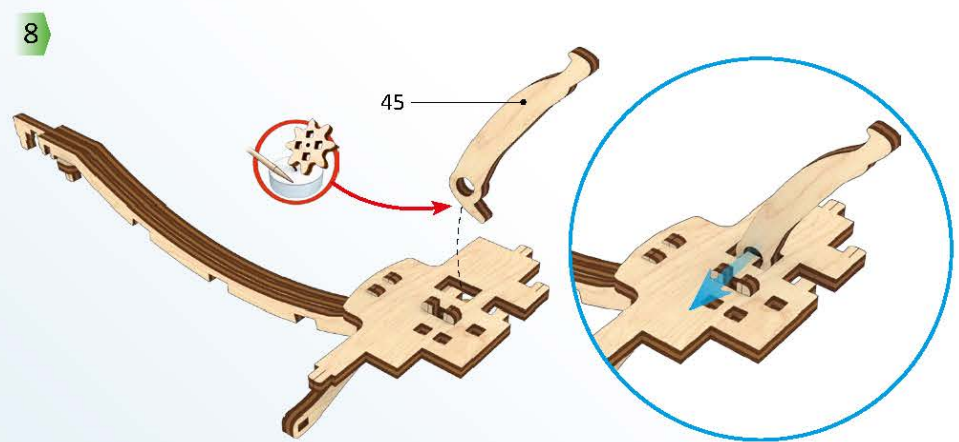
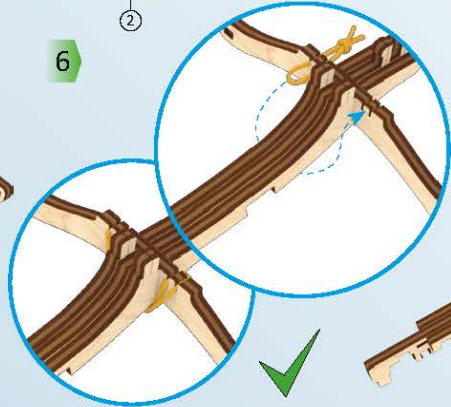
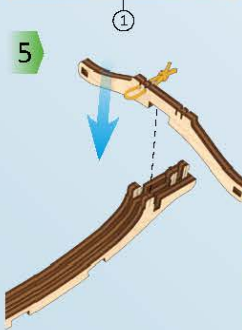
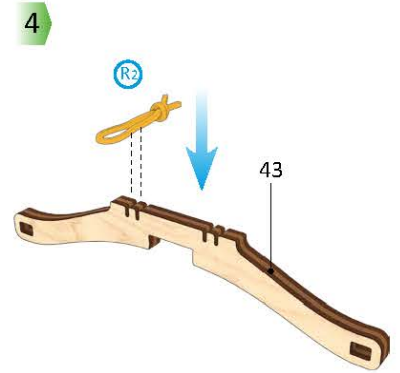
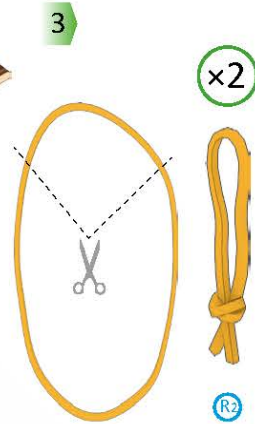
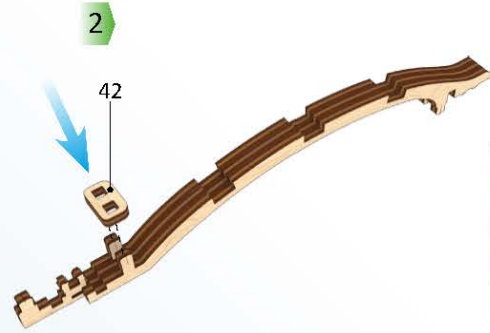
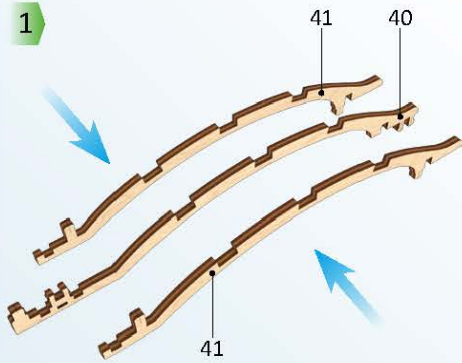
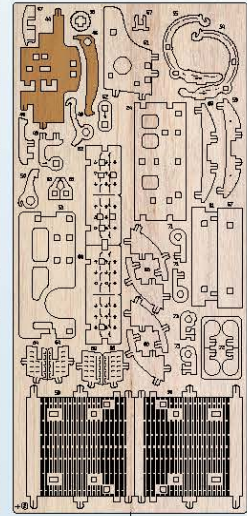
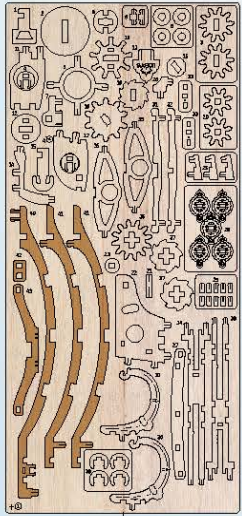

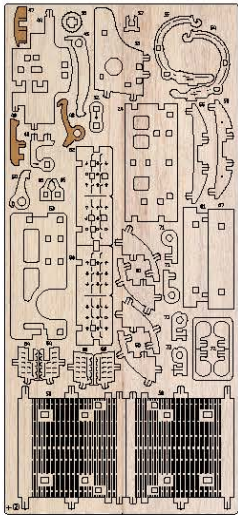

1

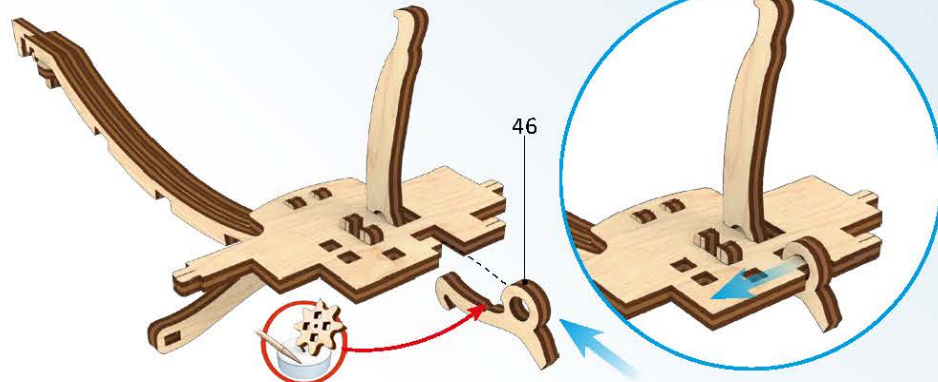

2

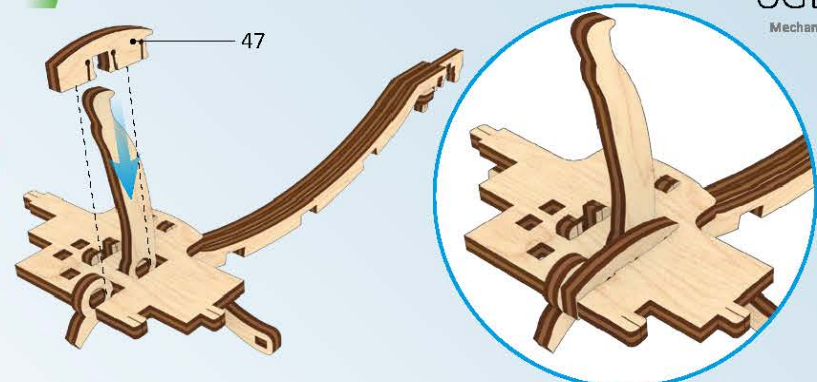

3

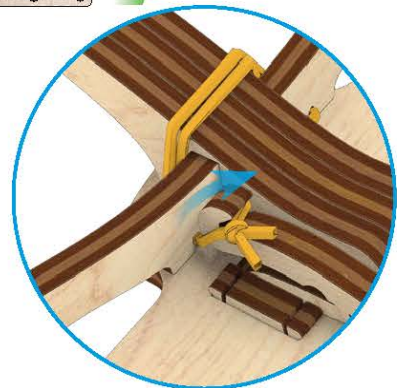

4

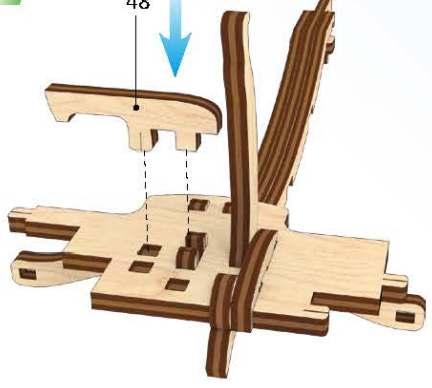

5

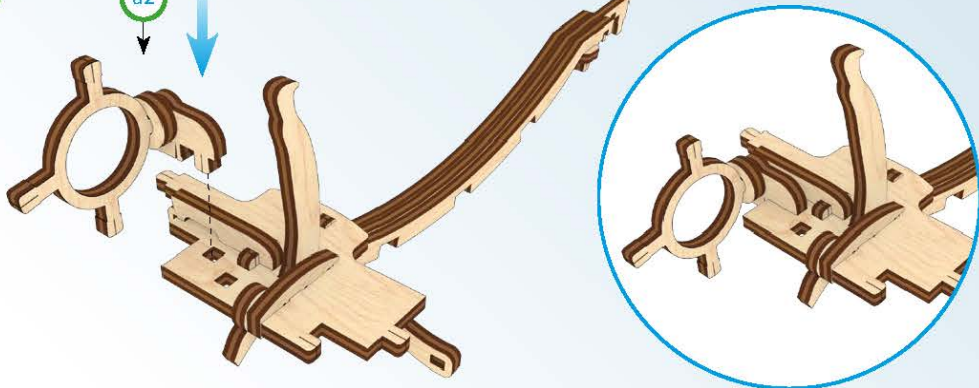

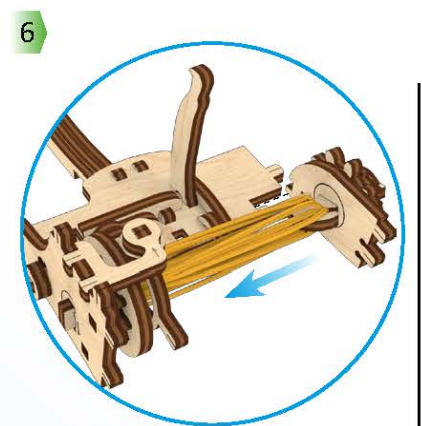
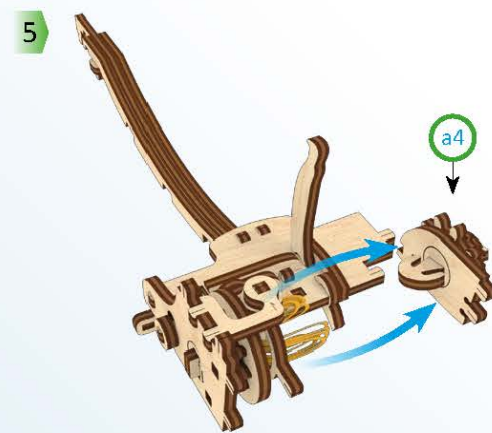
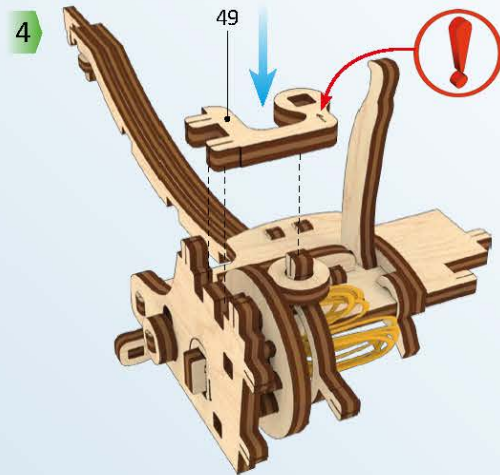
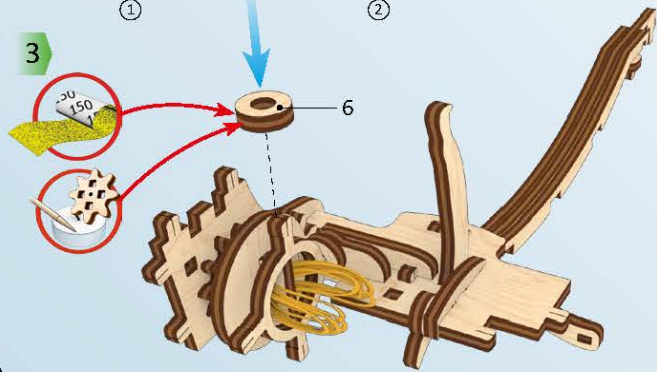
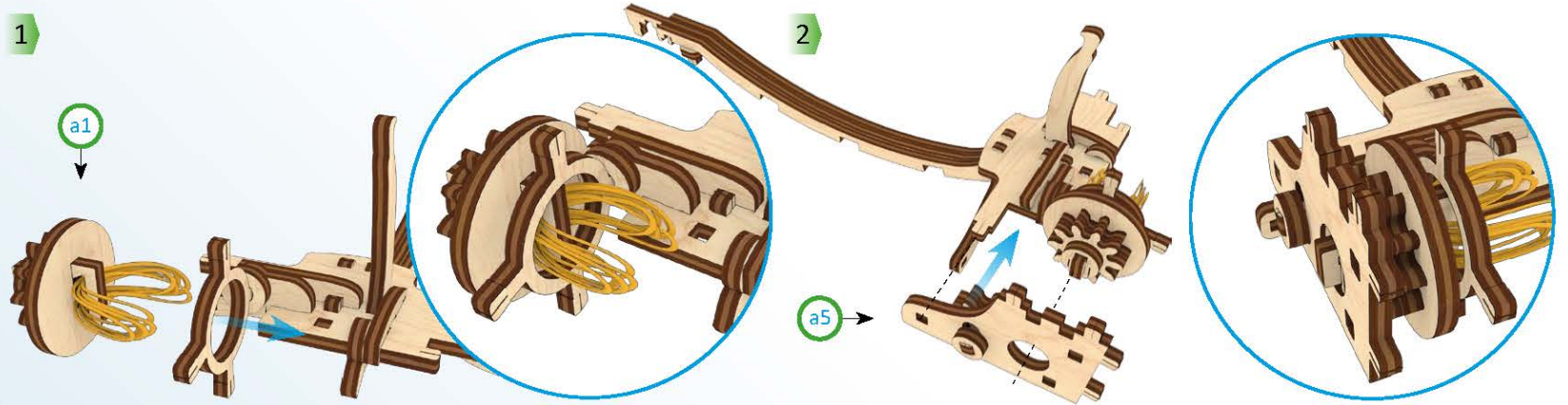
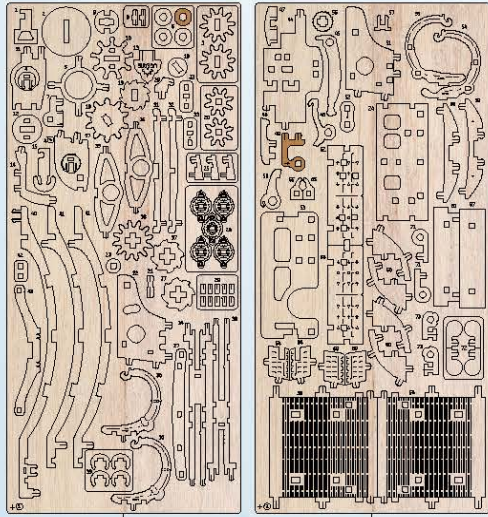

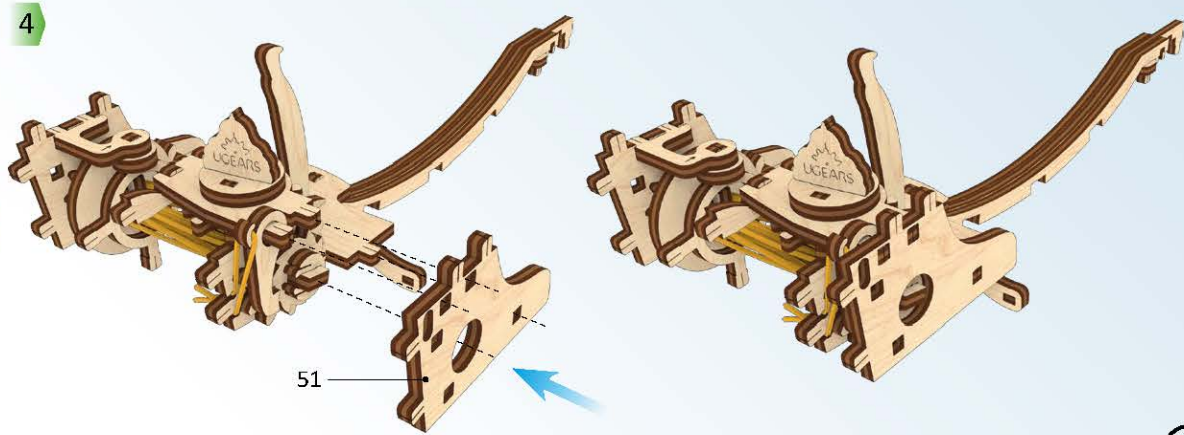
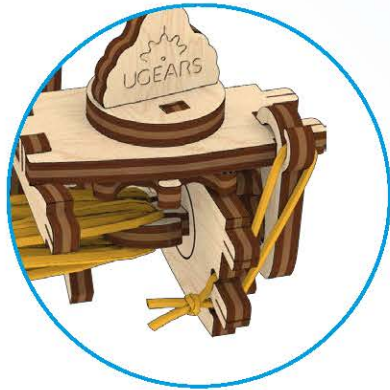
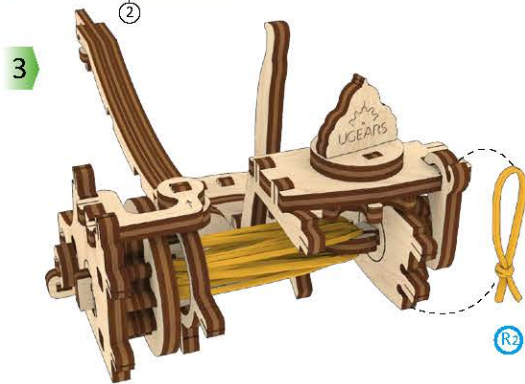
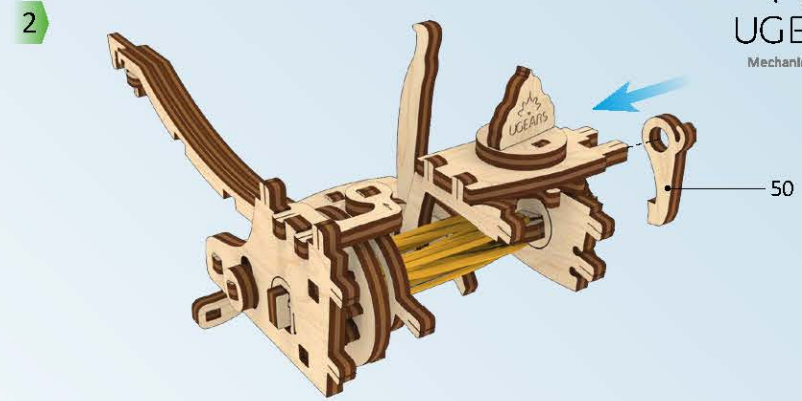
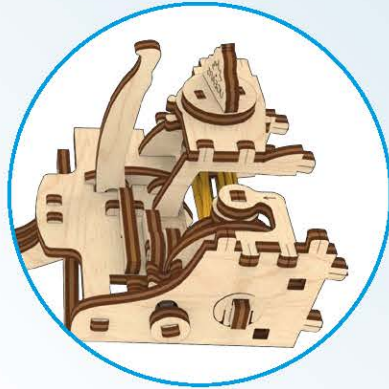
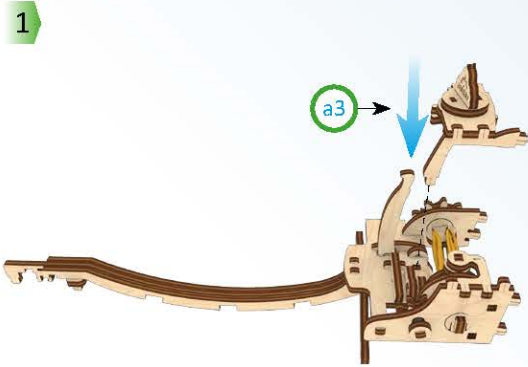
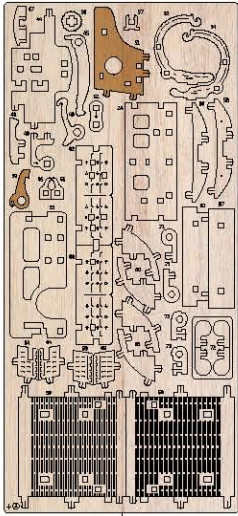

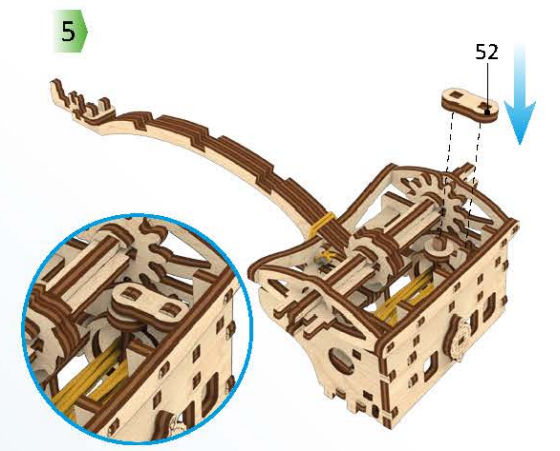
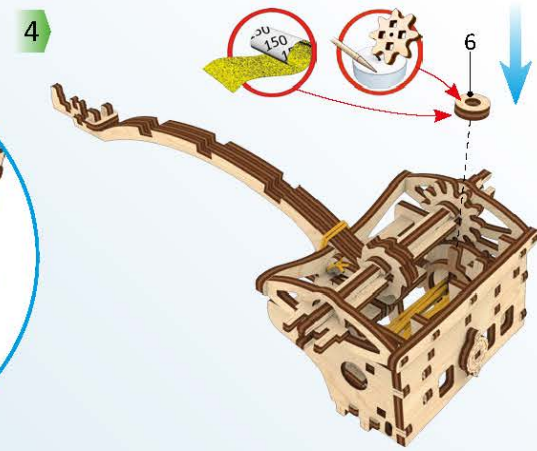
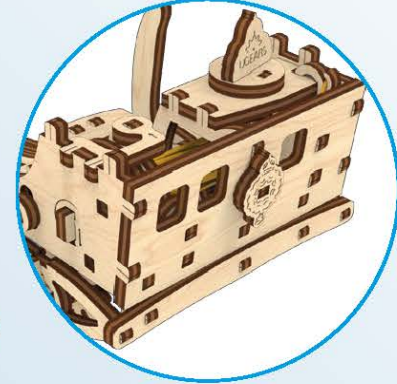
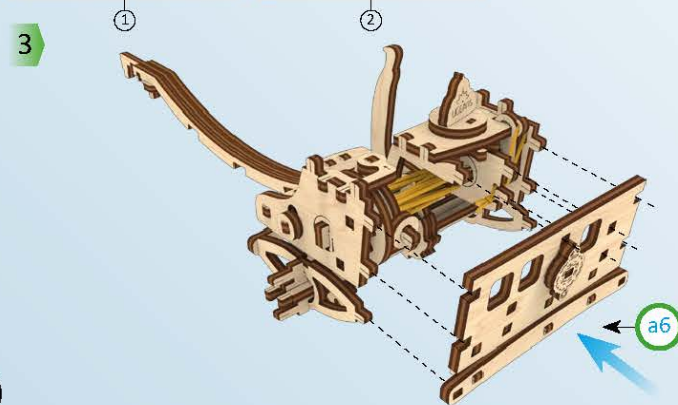
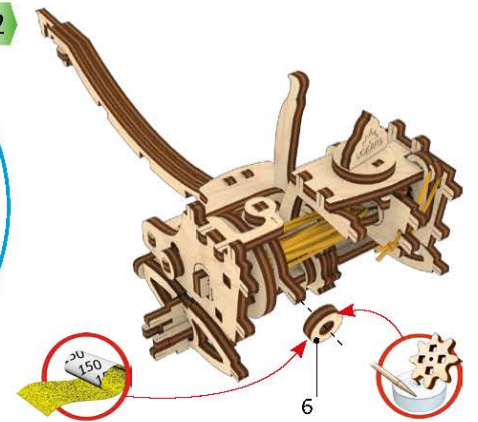
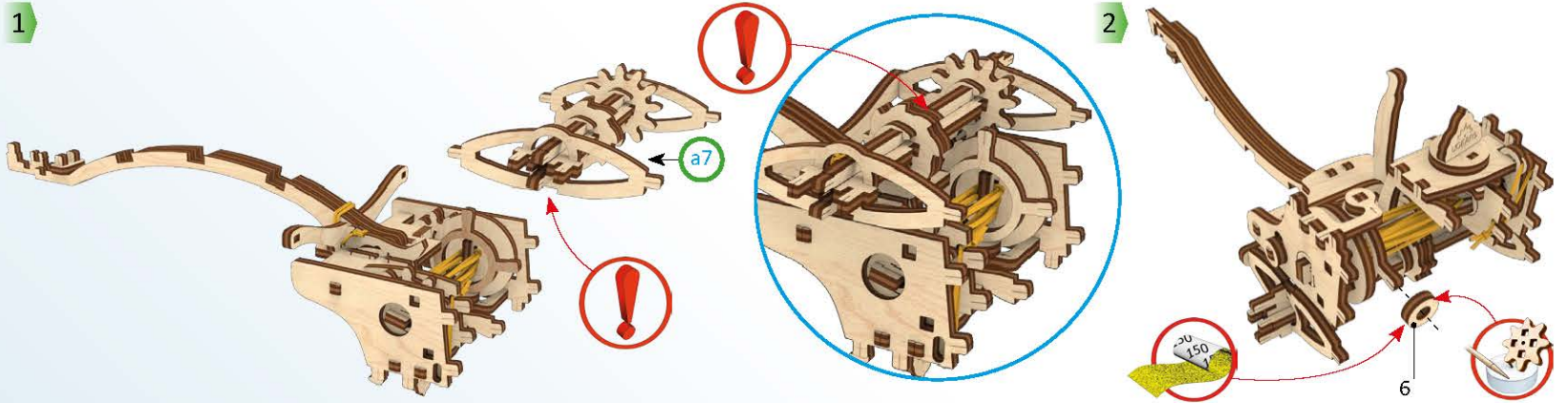
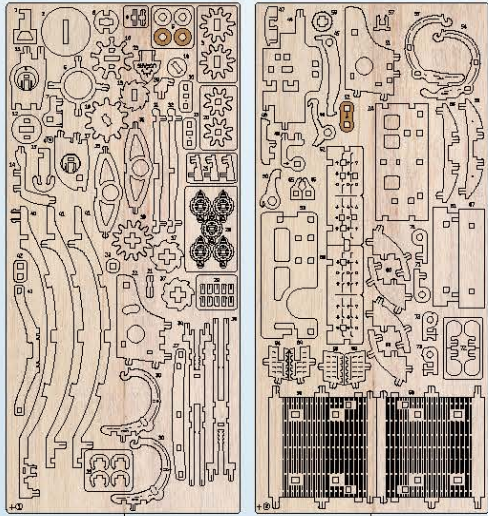

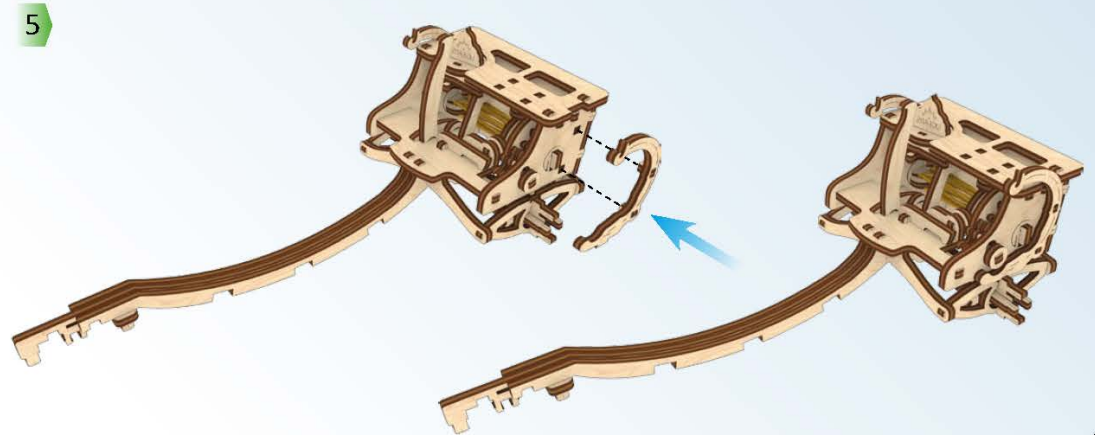
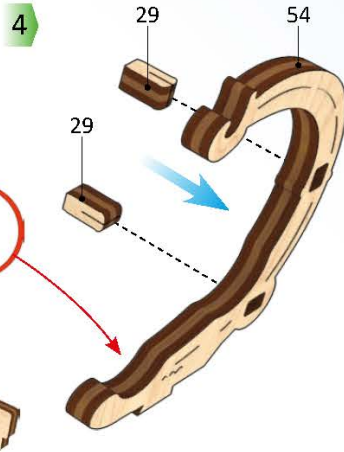
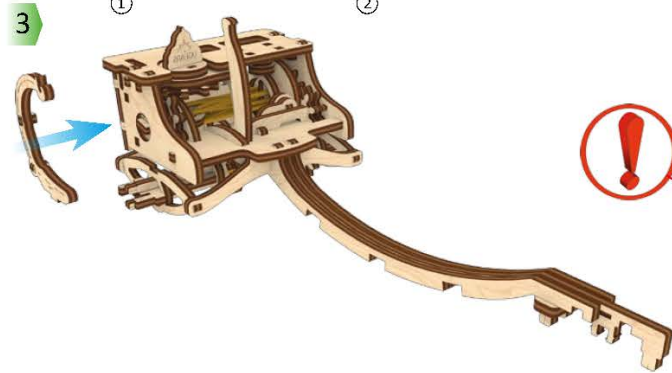
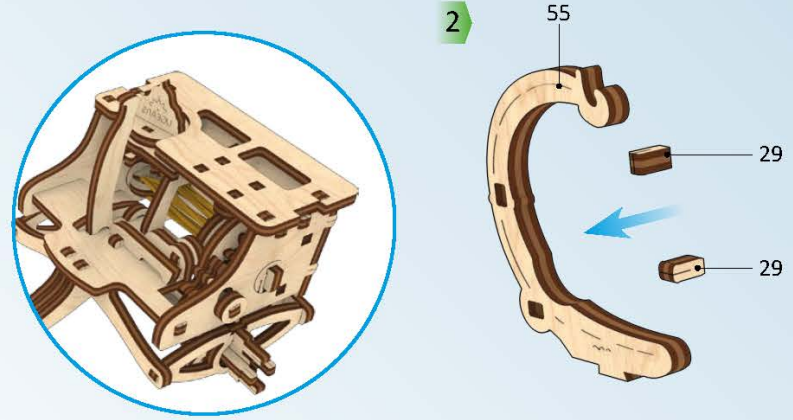
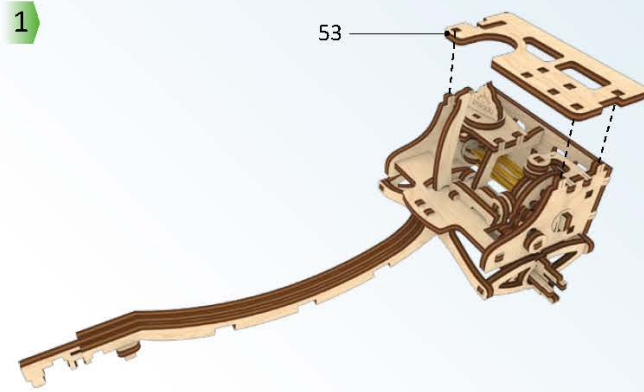
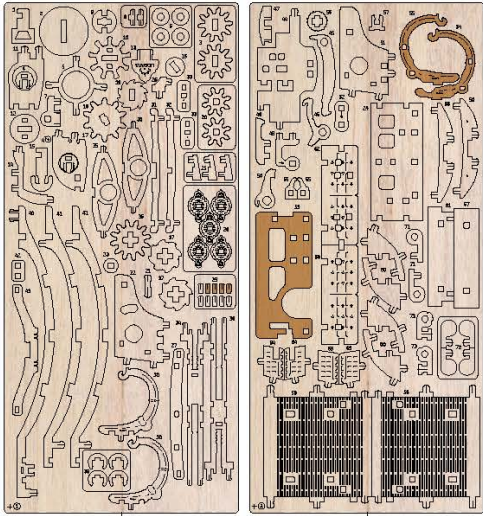

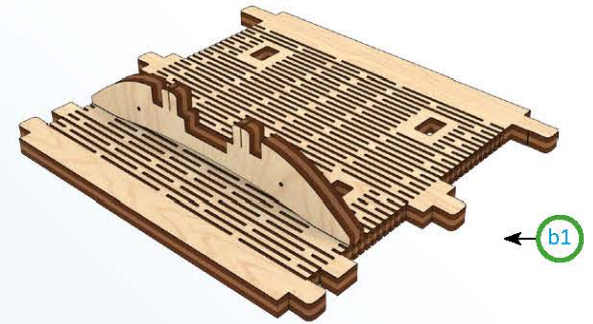
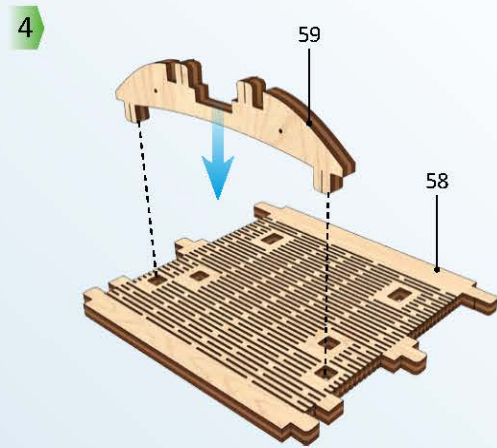
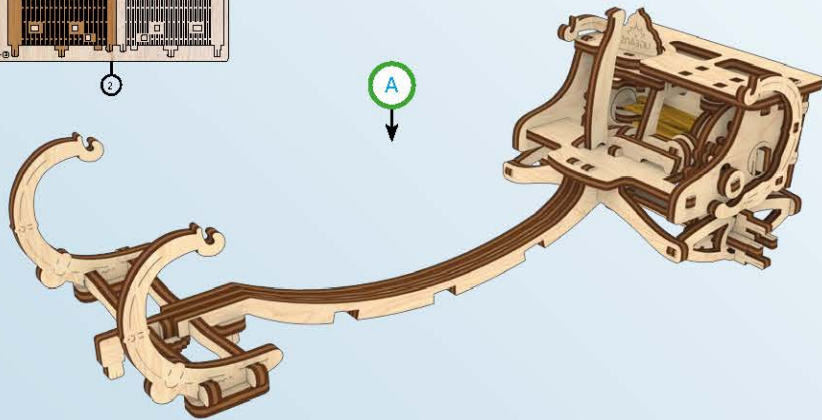
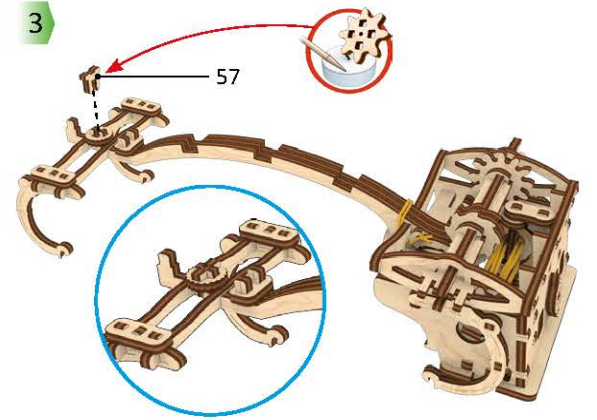
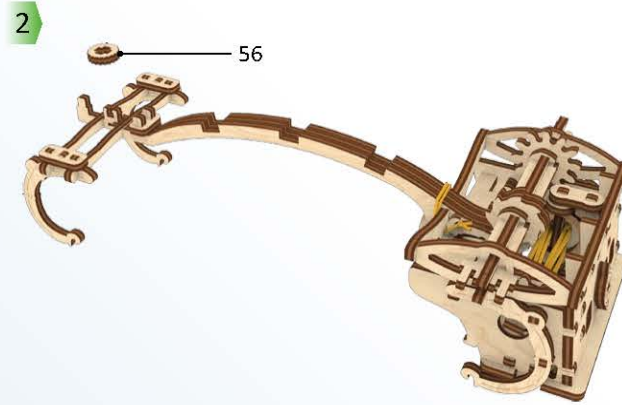
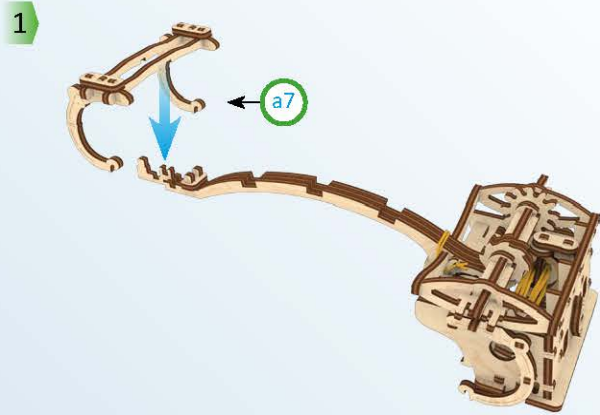
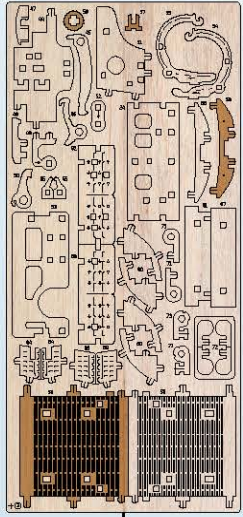

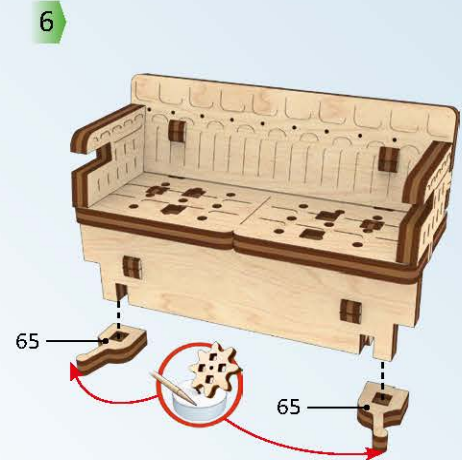
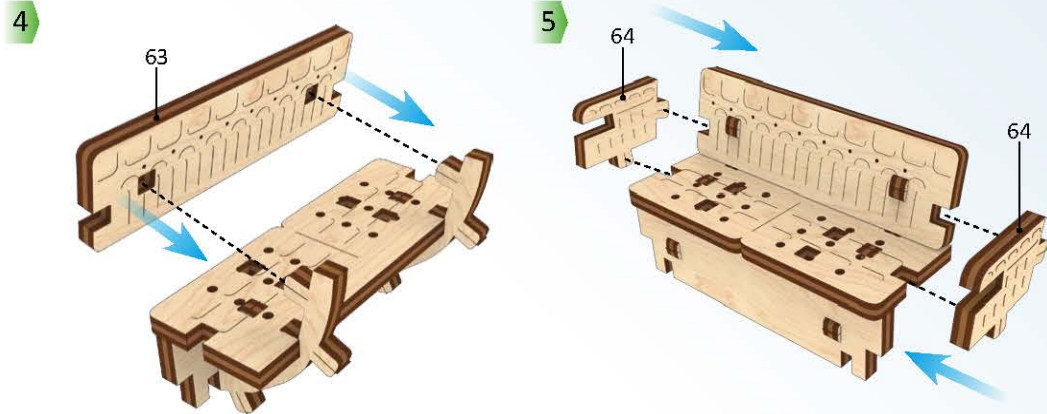
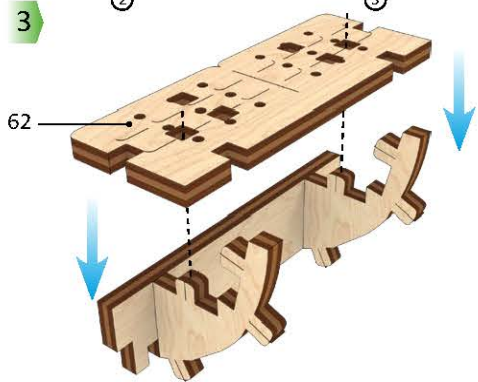
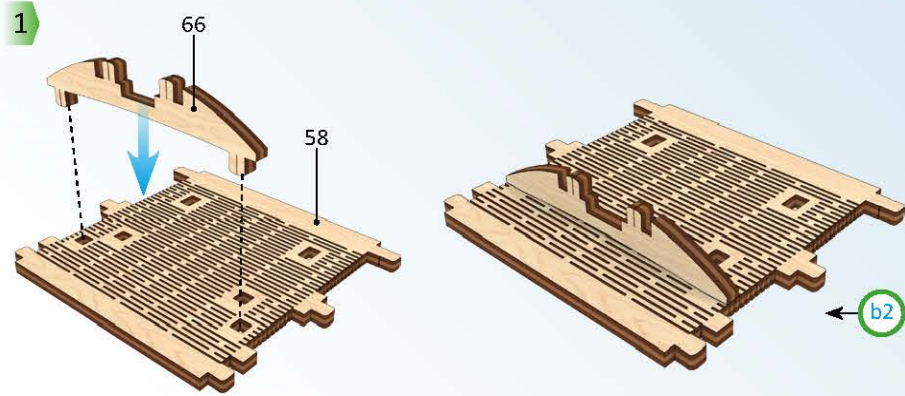
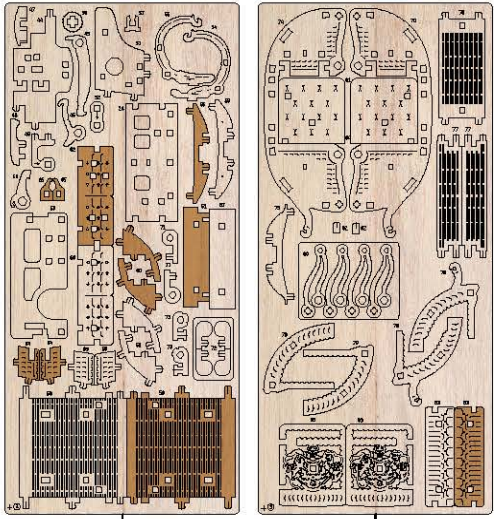

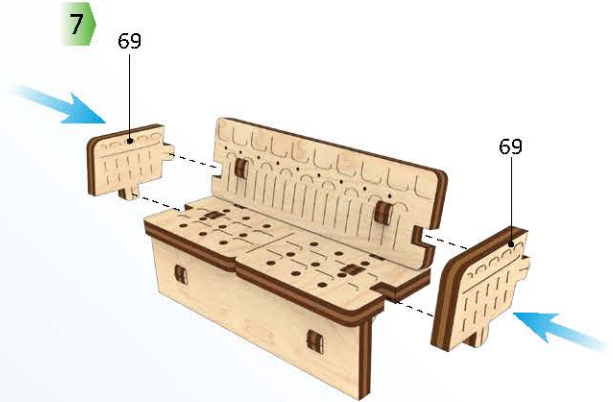
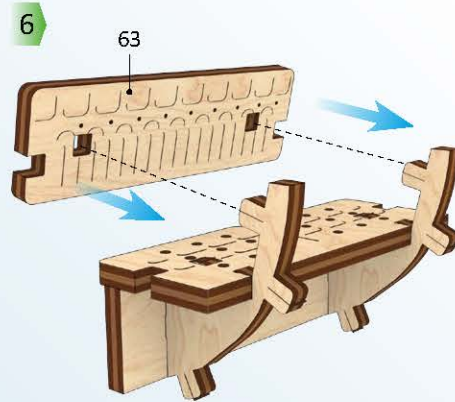
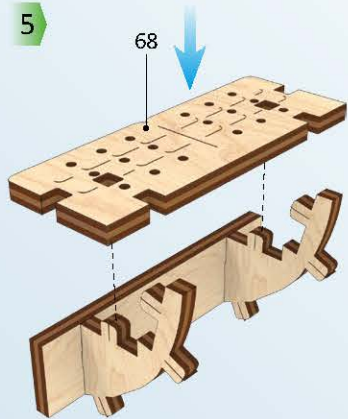
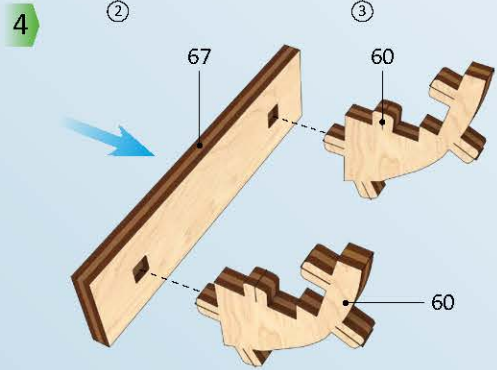
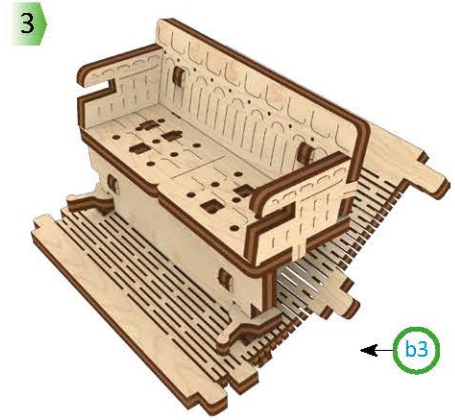
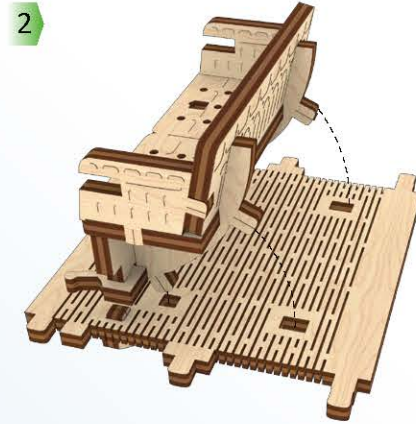
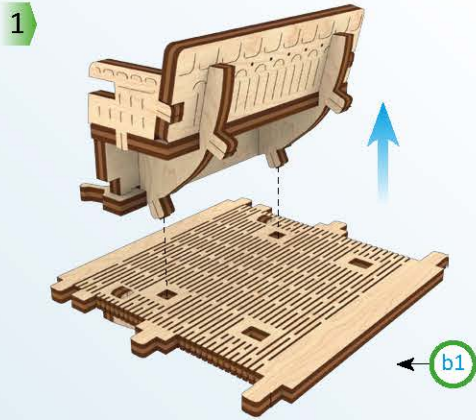
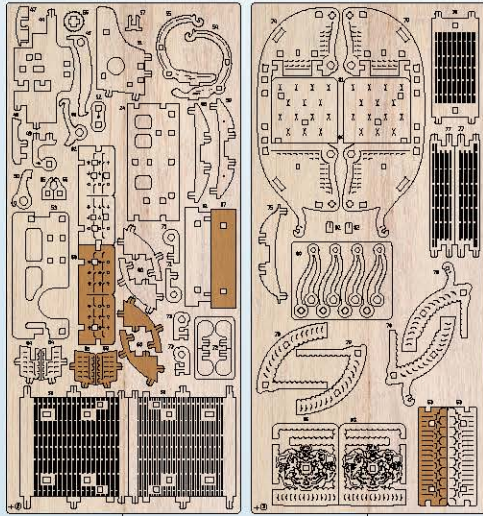

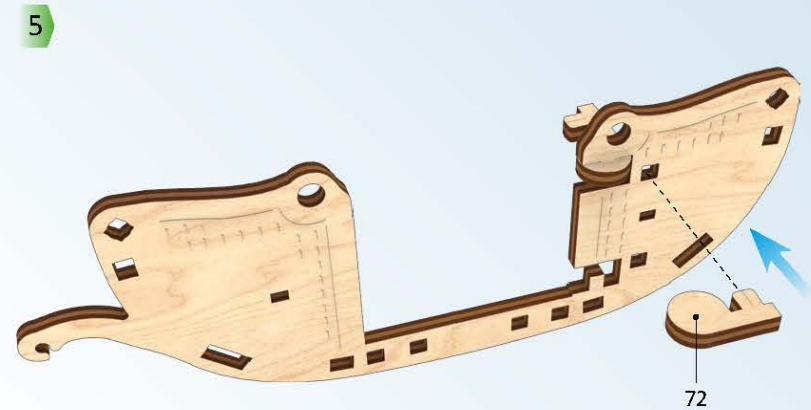
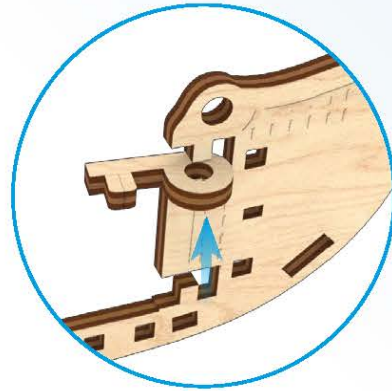
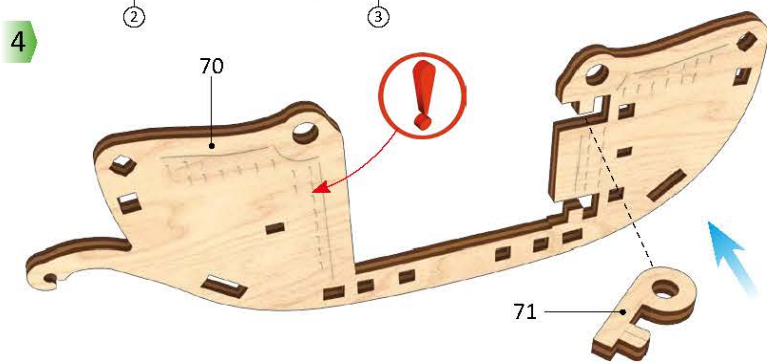
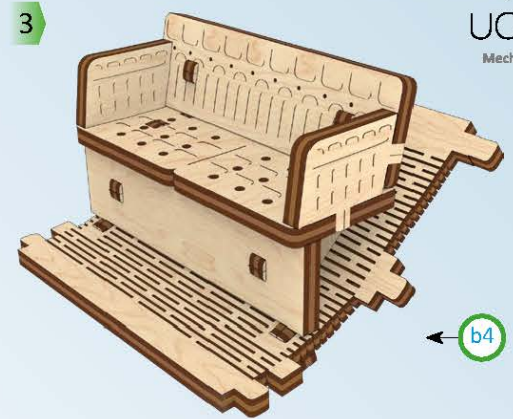
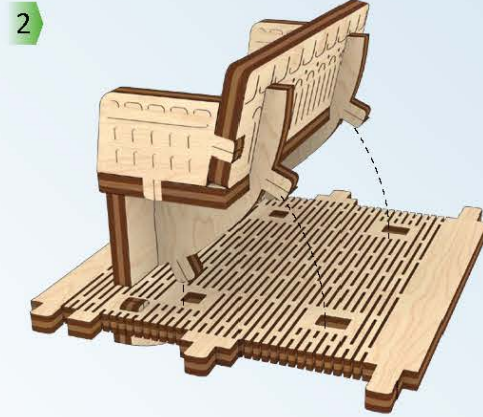
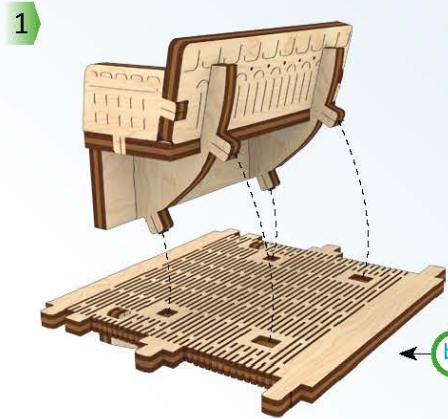
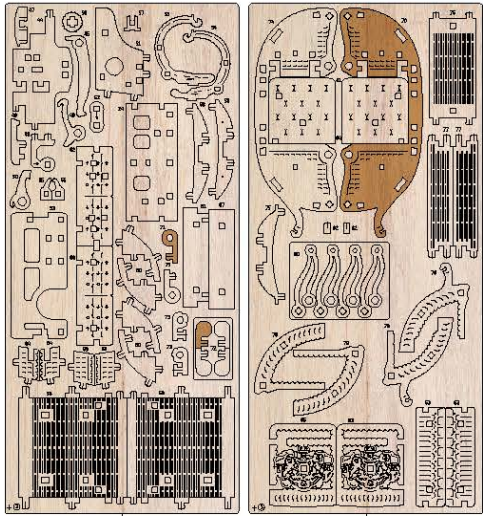

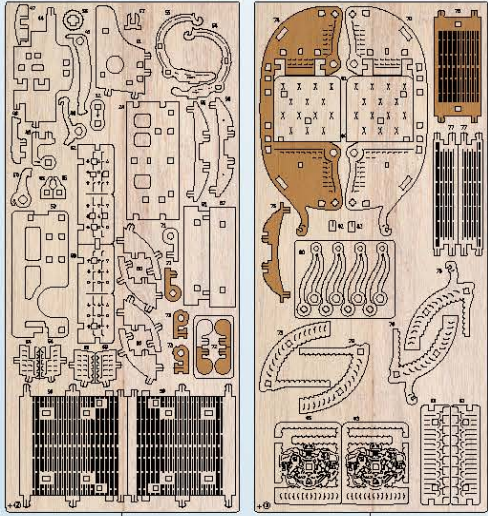

2

3

1

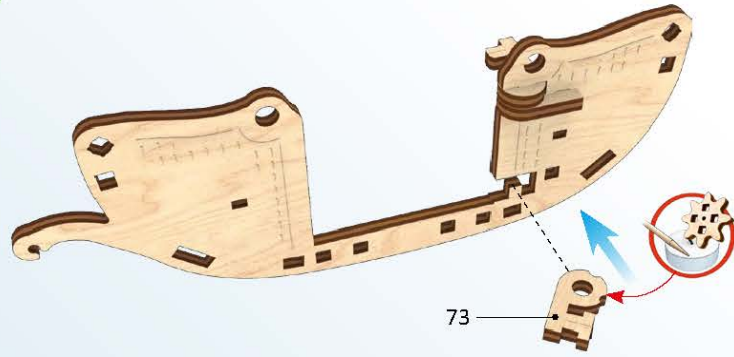

73

2



3

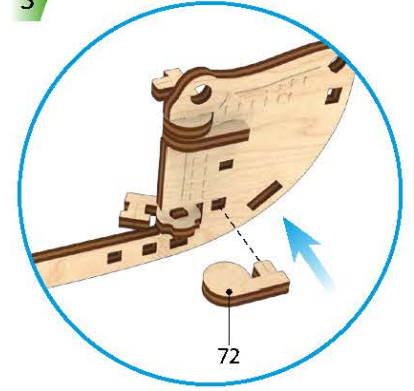

72

4

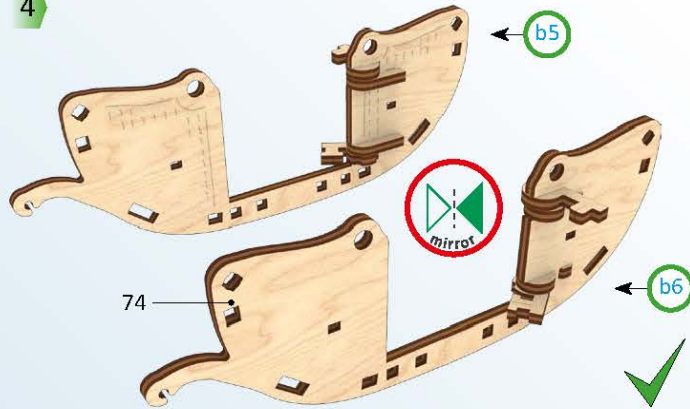

74

b5

b6

5

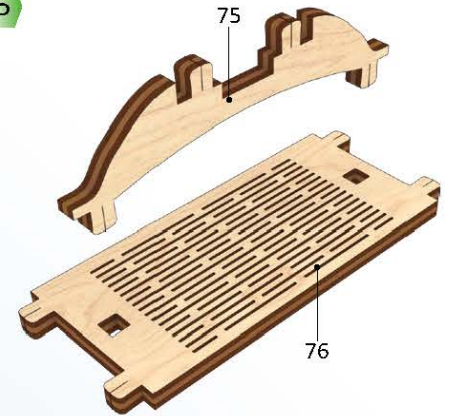

75

76

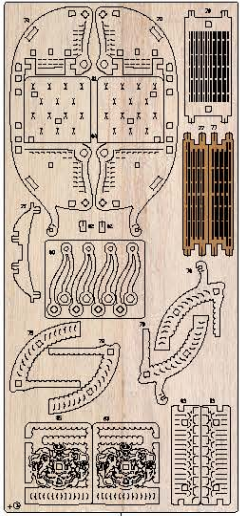

3

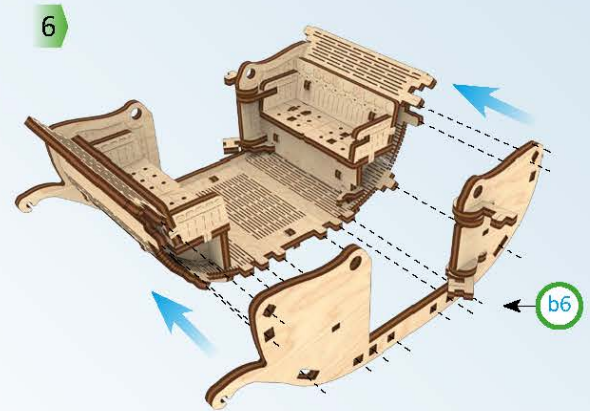
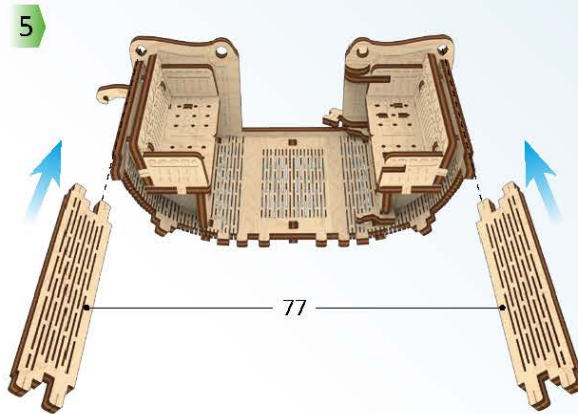
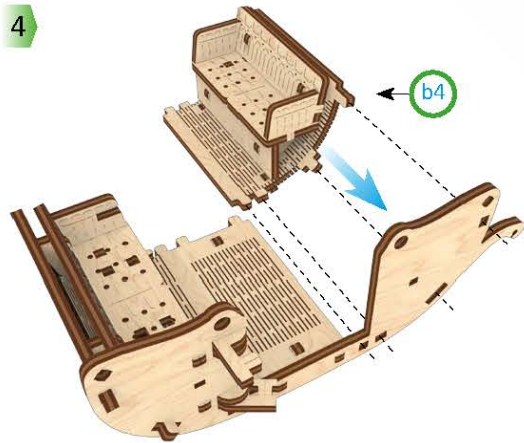
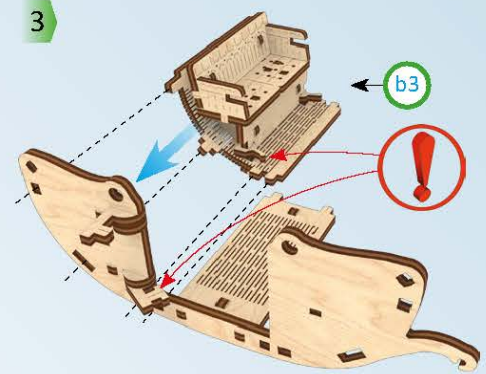
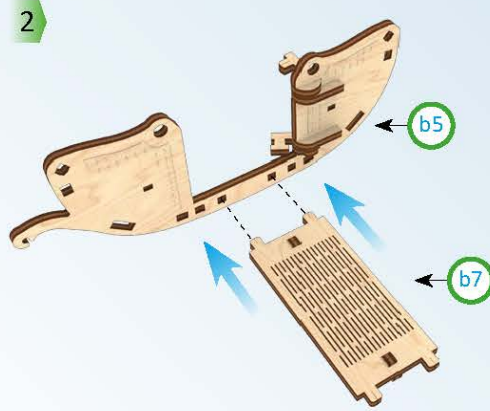
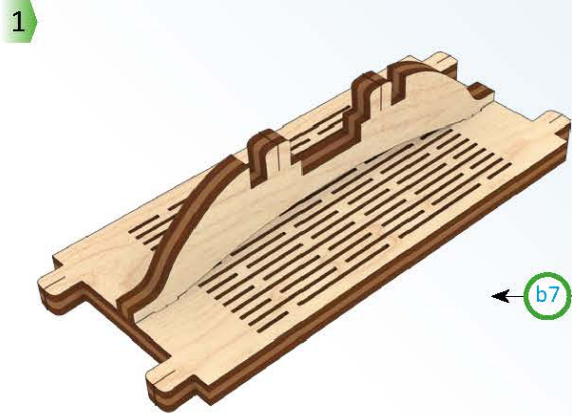

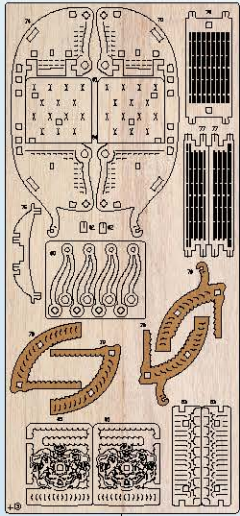

3

1

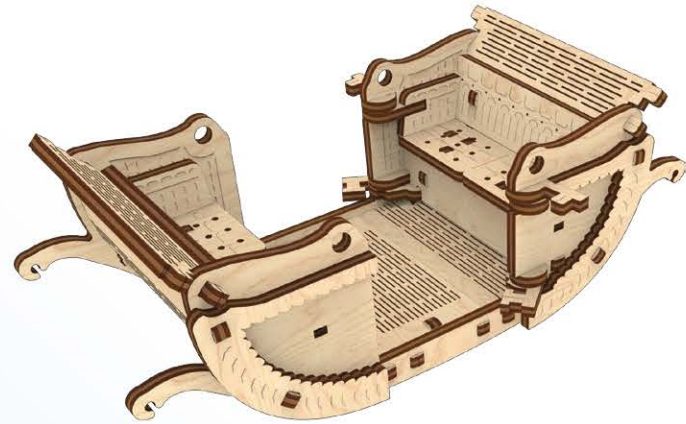
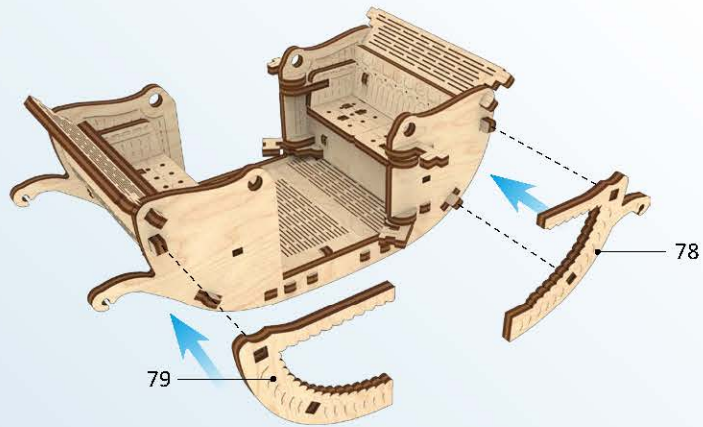

2

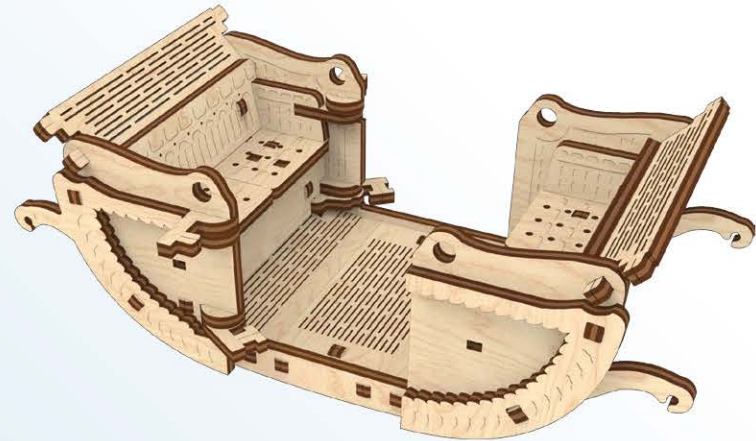
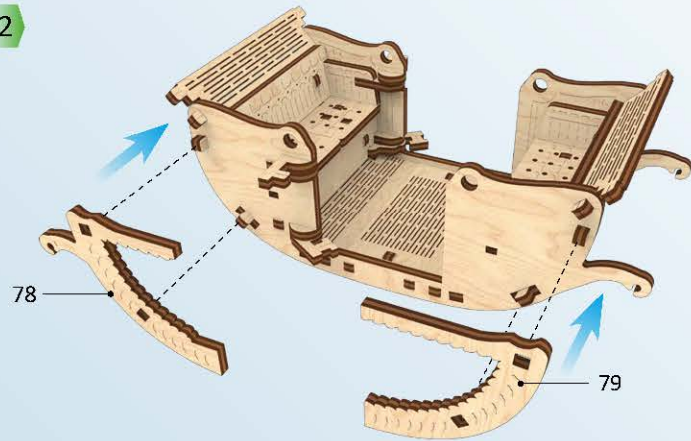

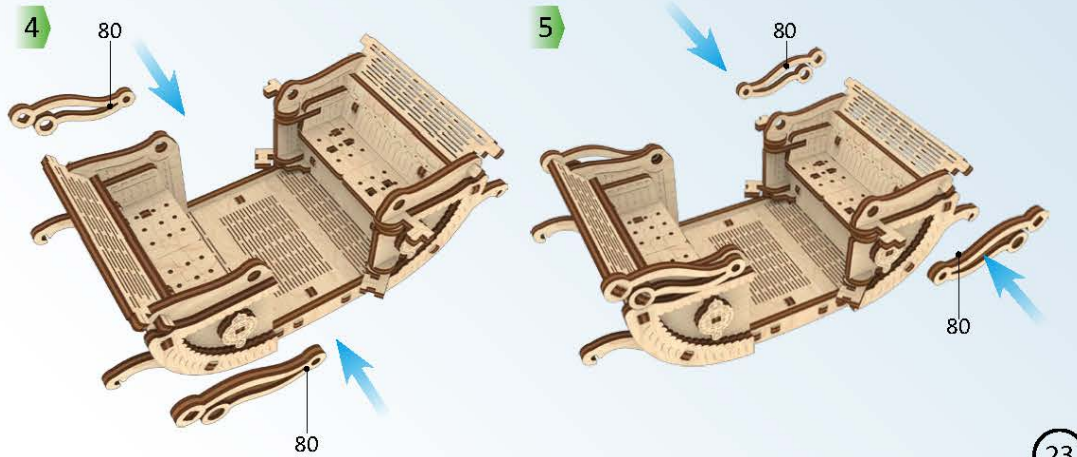
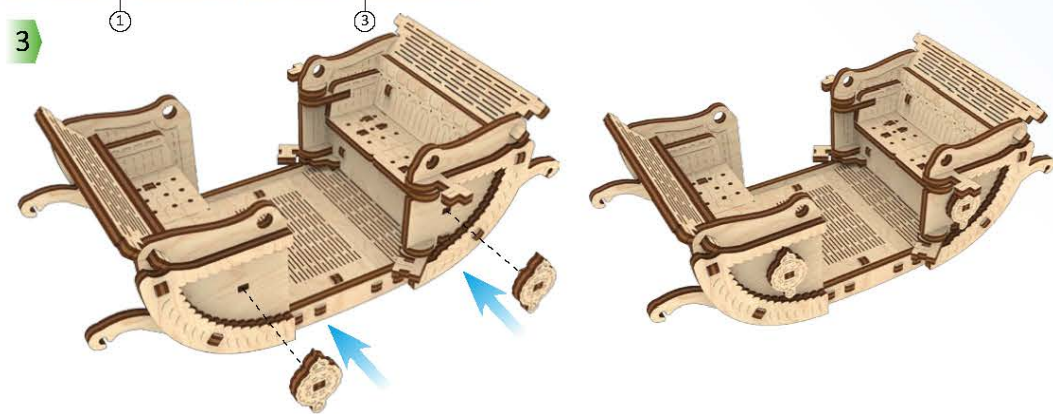
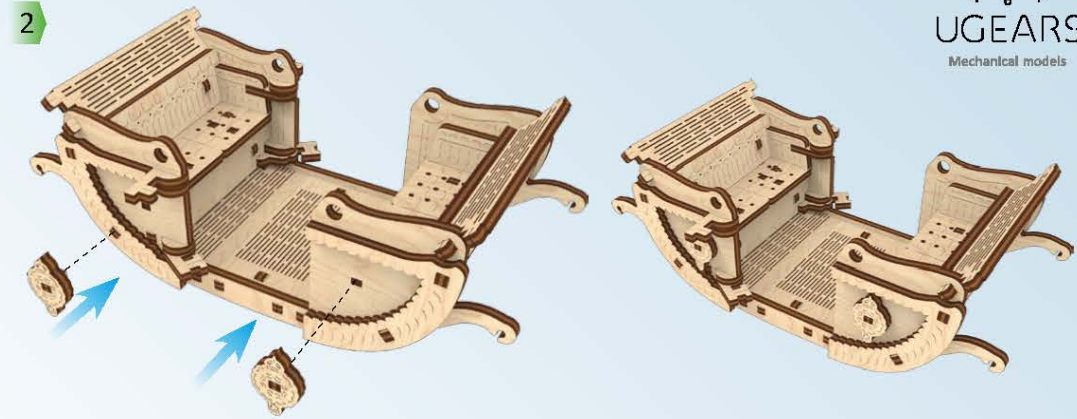
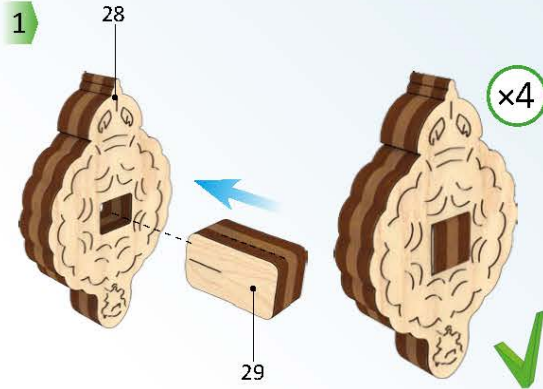
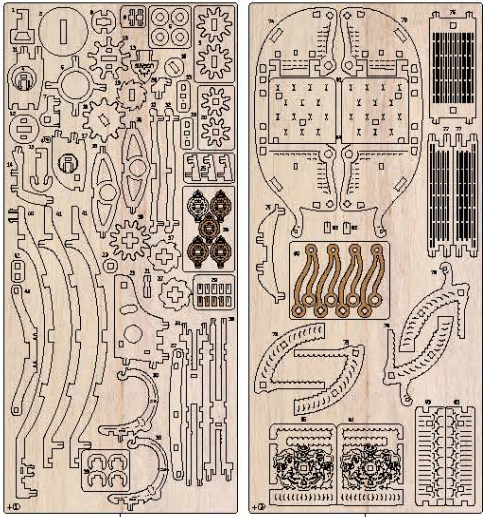

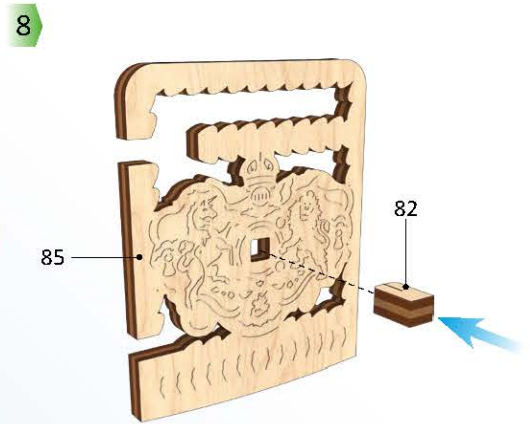
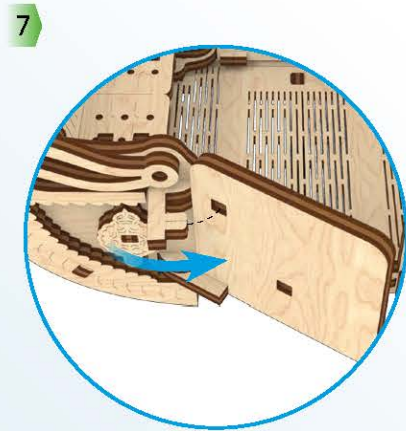
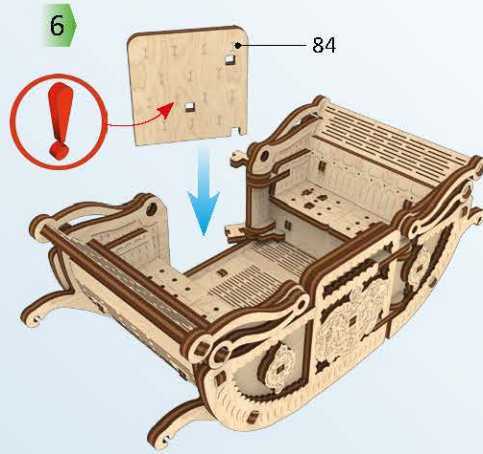
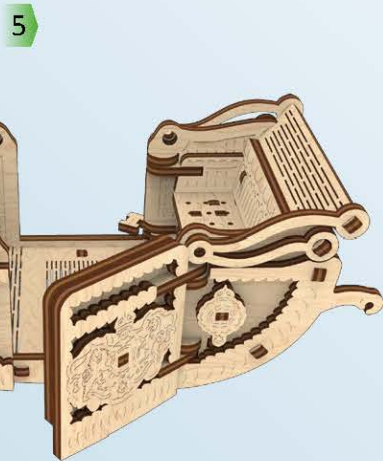
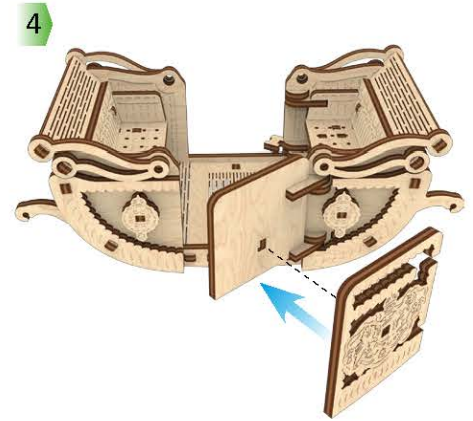
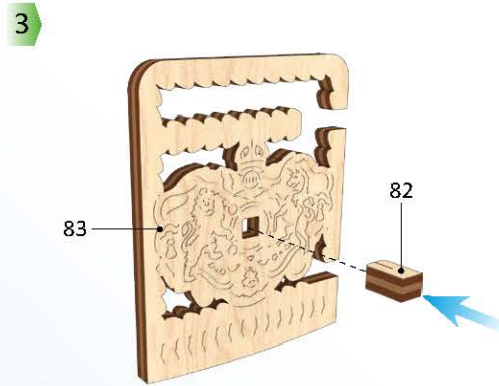
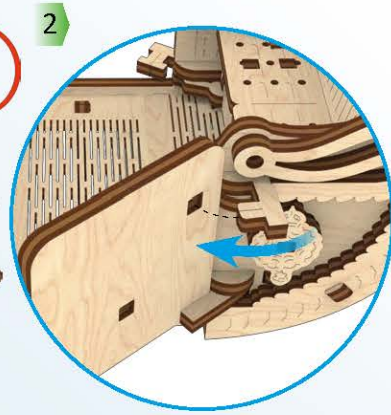
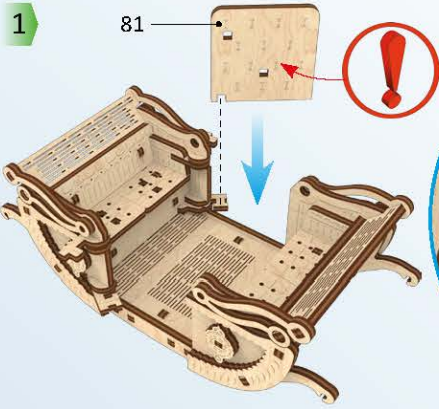
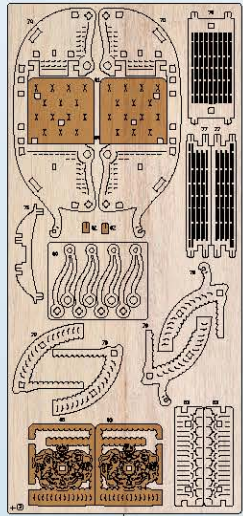

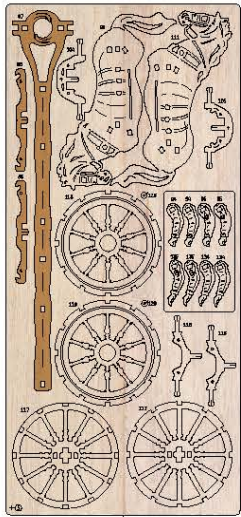

1

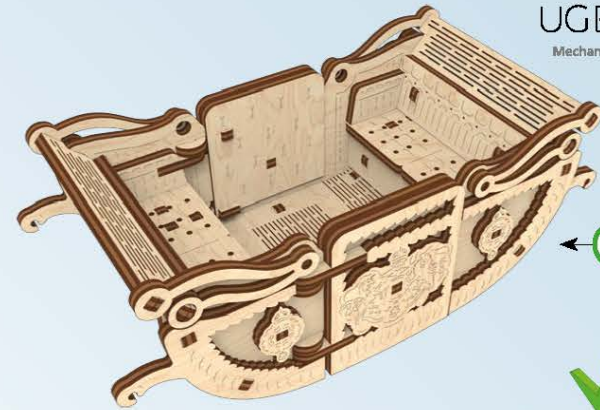
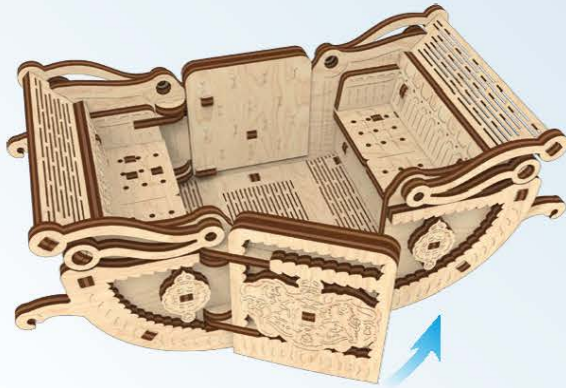
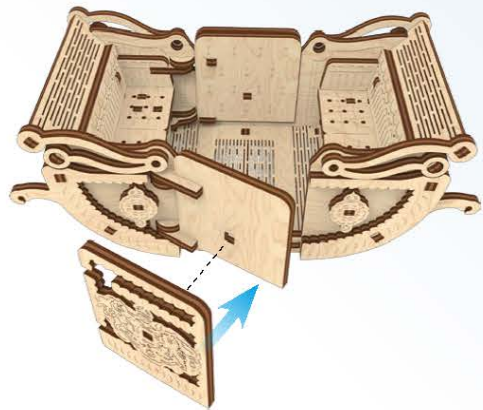

B



2

5

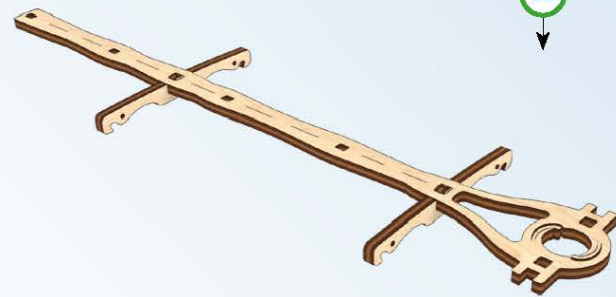
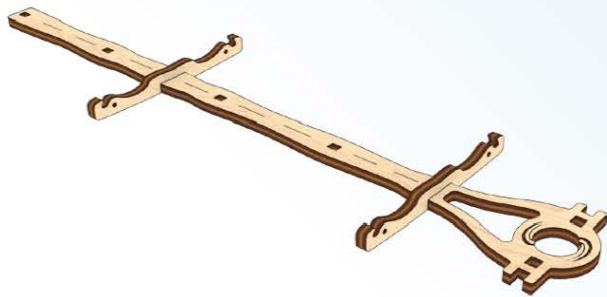
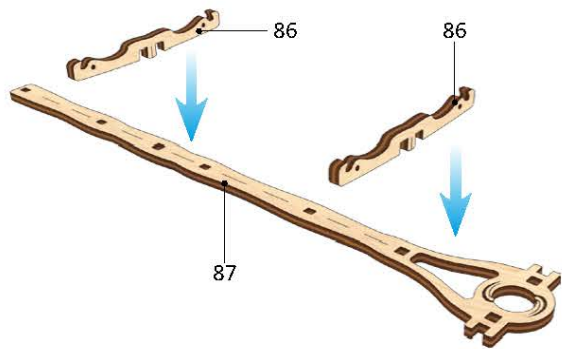

c1



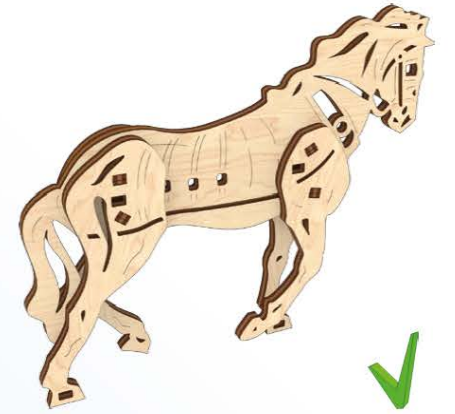
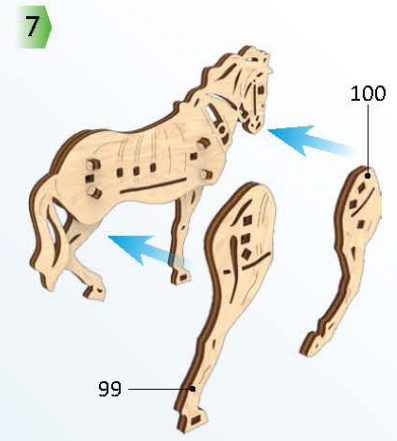
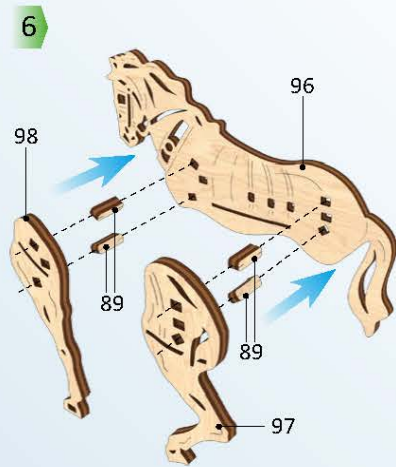
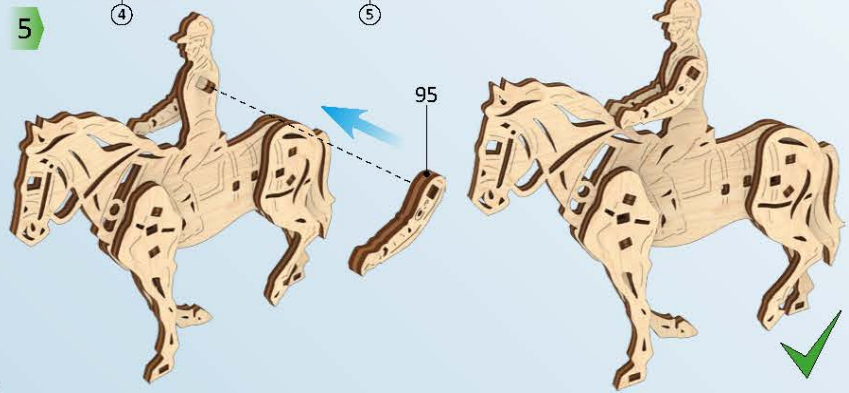
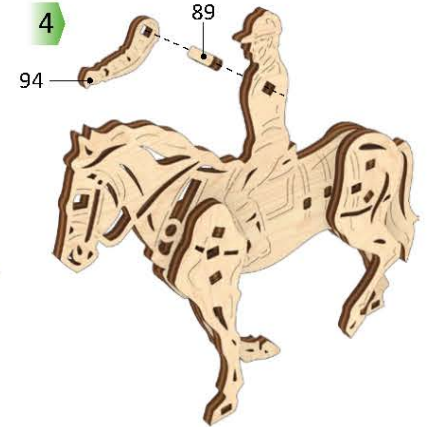
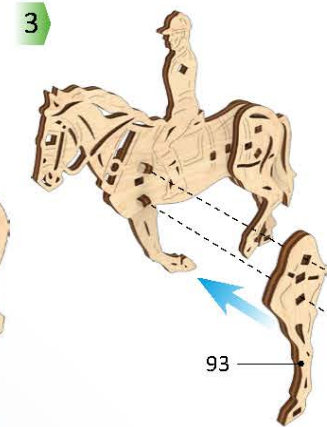
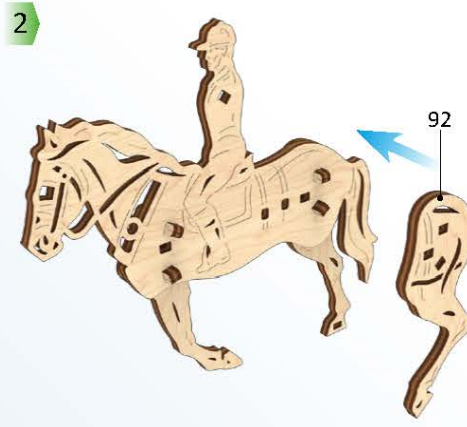
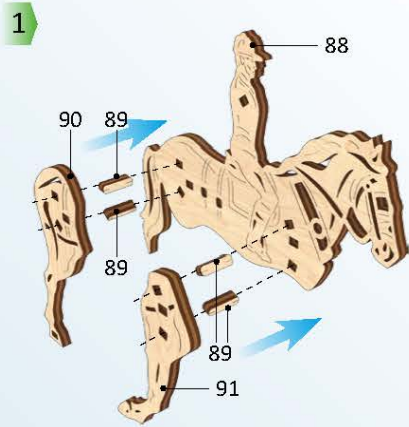
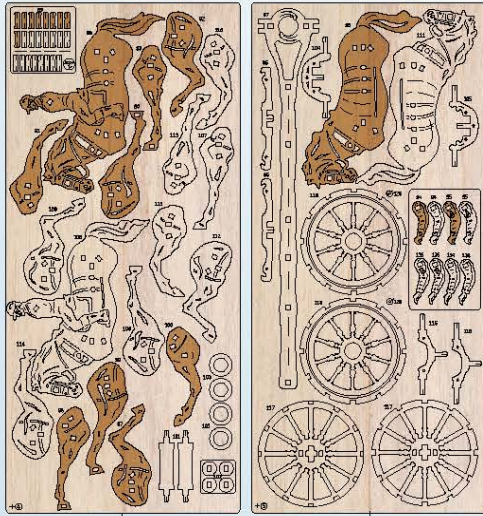

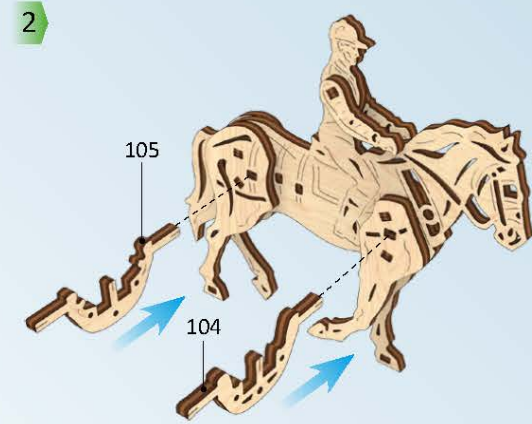
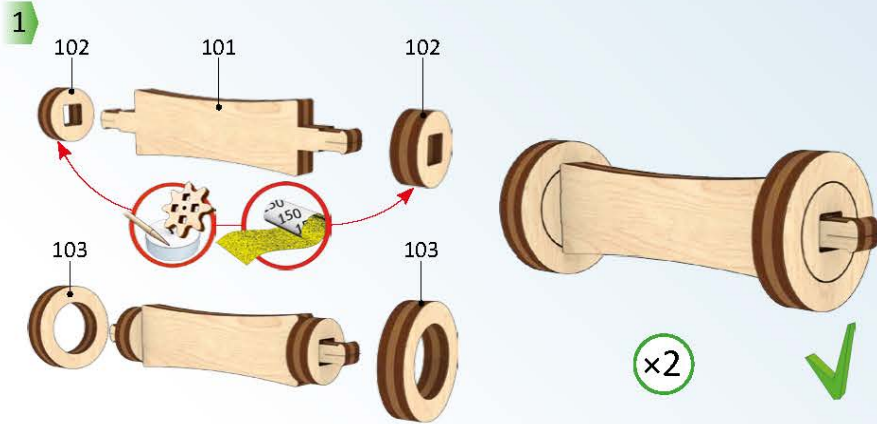
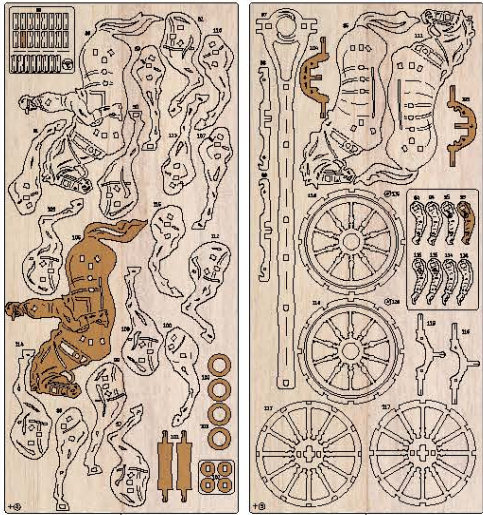

Mechanical models

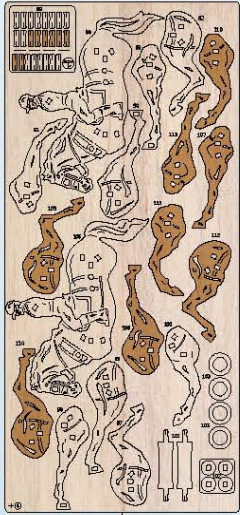

4

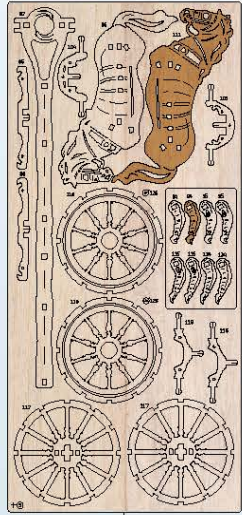

5

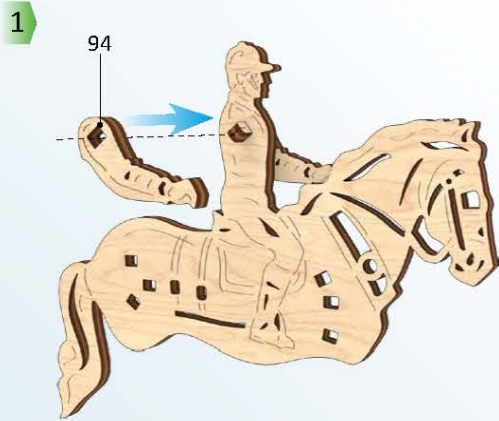

1

94

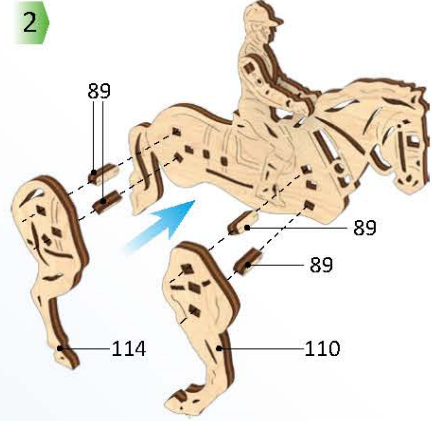

2

89

89

89

114

110

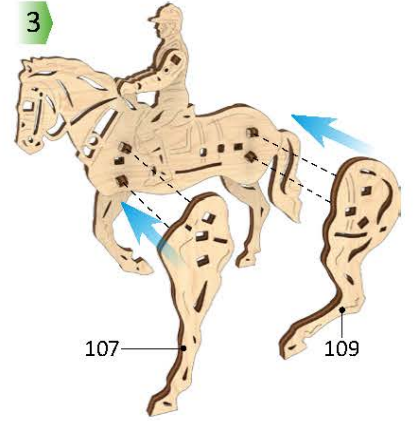

3

107

109

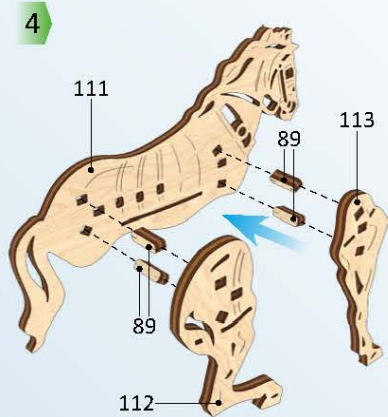
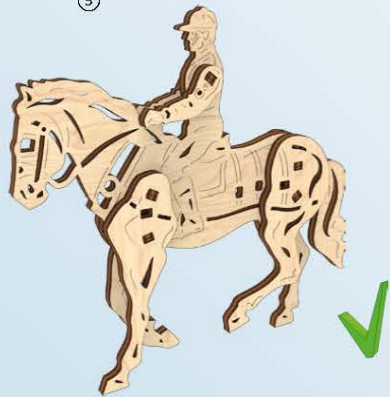

4

111

89

113

89

112

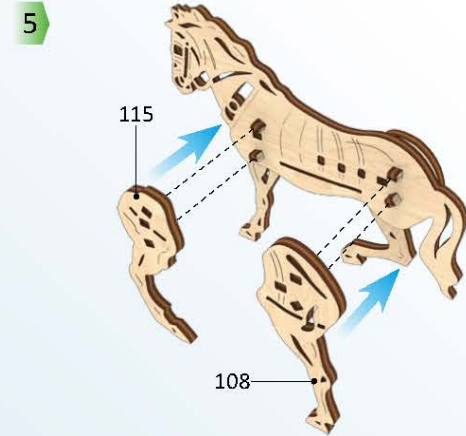

5

115

108



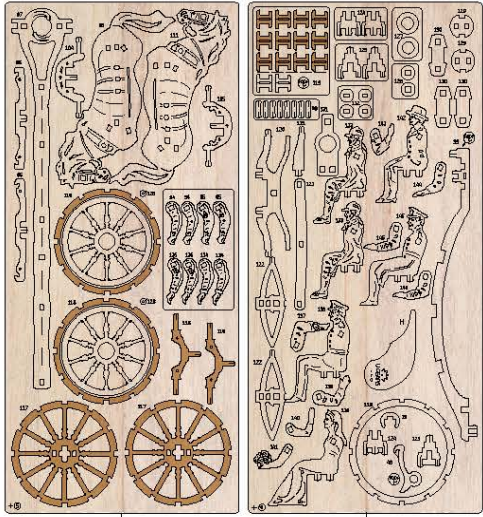

5

6

1

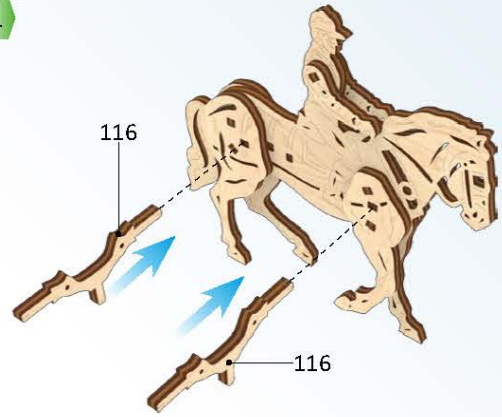

2



c3



3

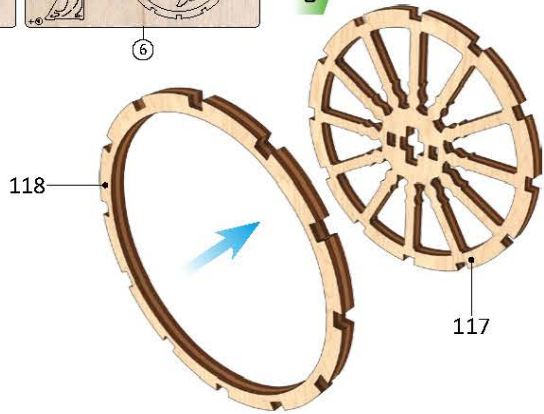

4

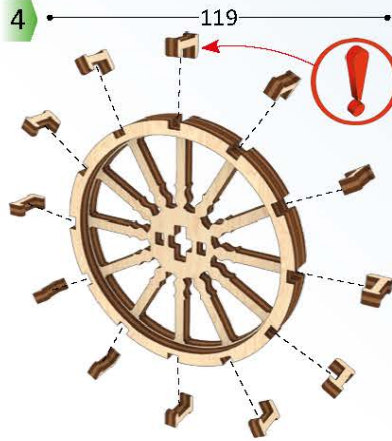

5

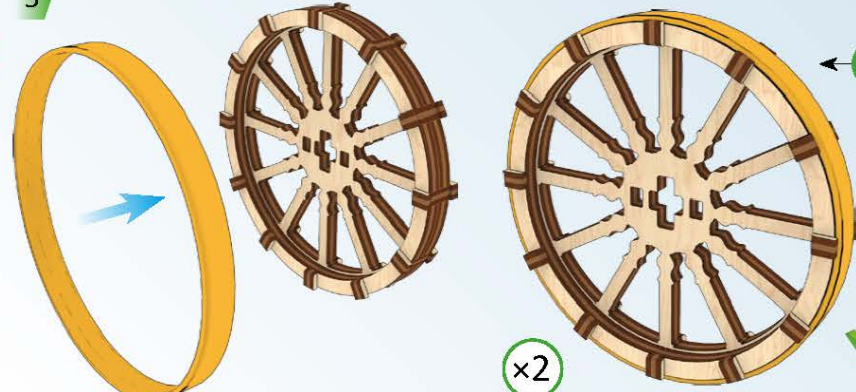

D



x2

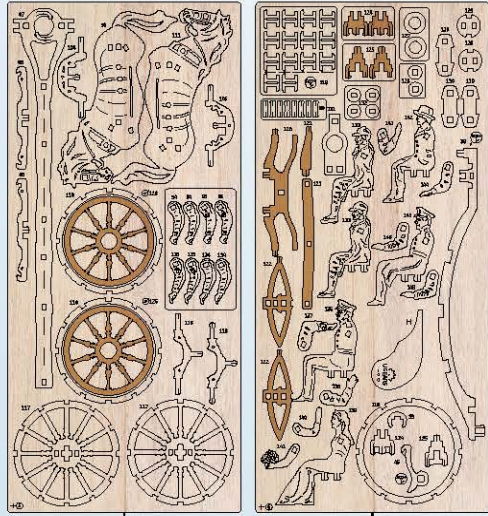

1

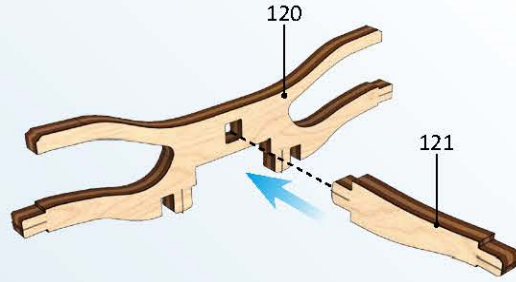

2



3



4

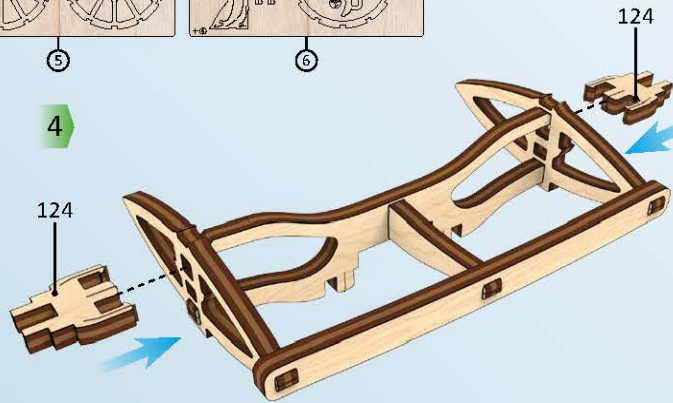

5

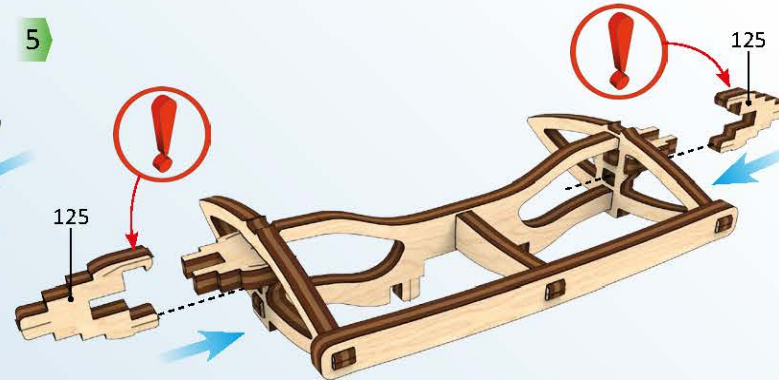

6

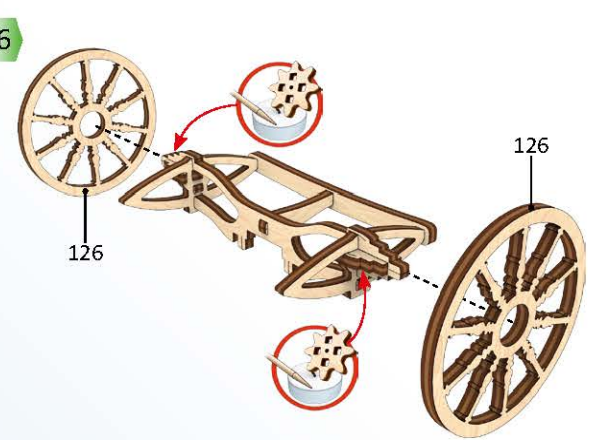

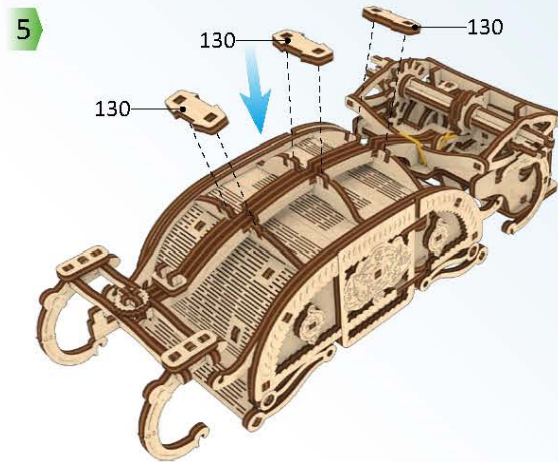
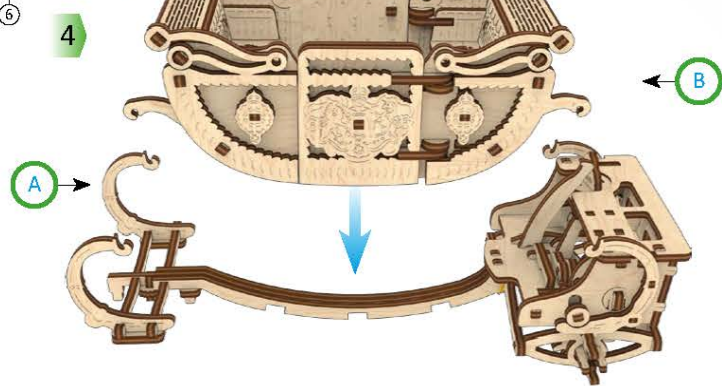
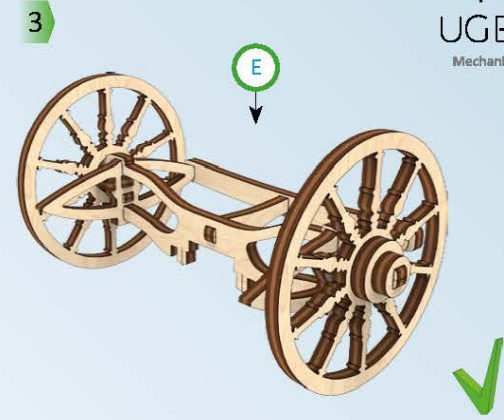
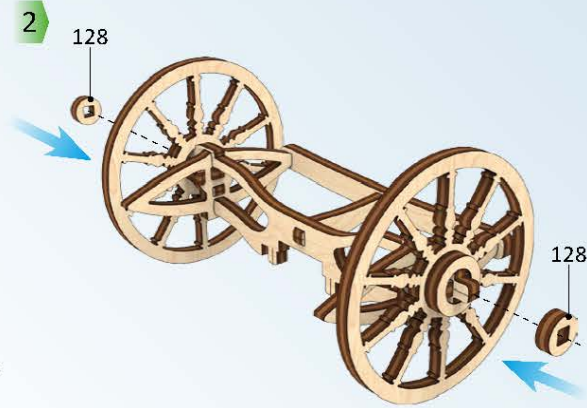
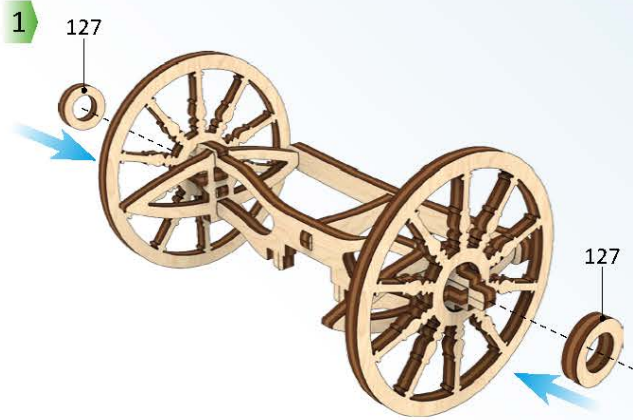
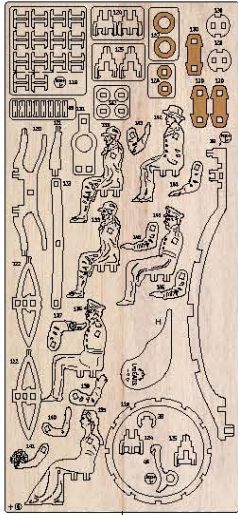

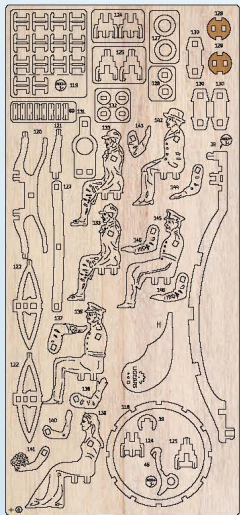

1



x4

R2

2

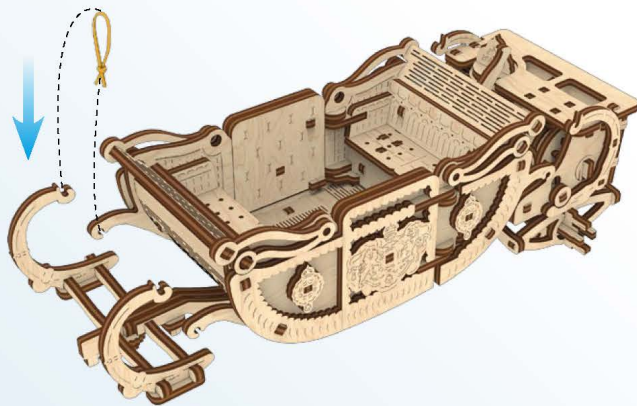

3

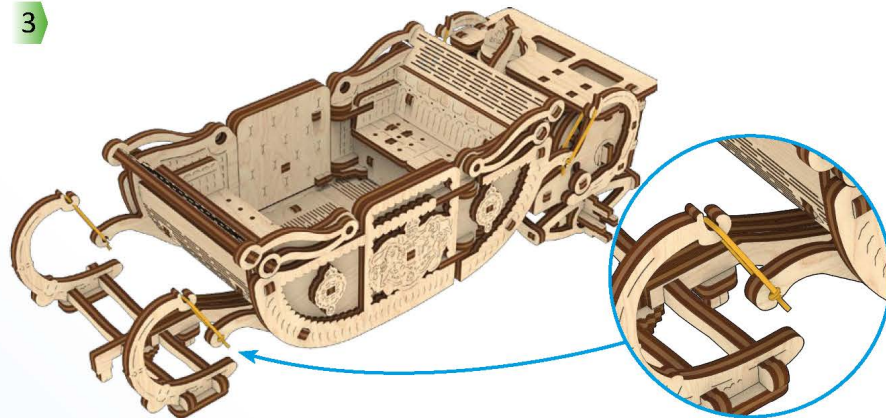

4

D

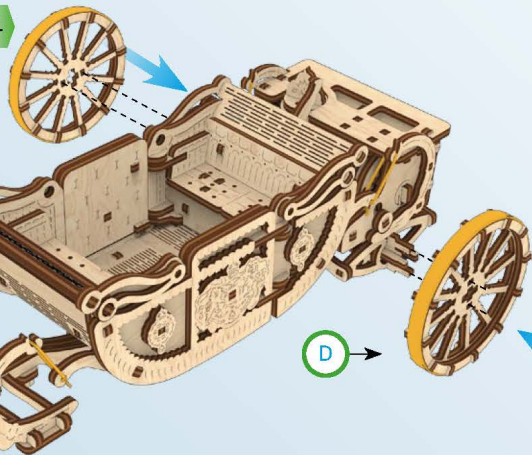

D

5

129

129

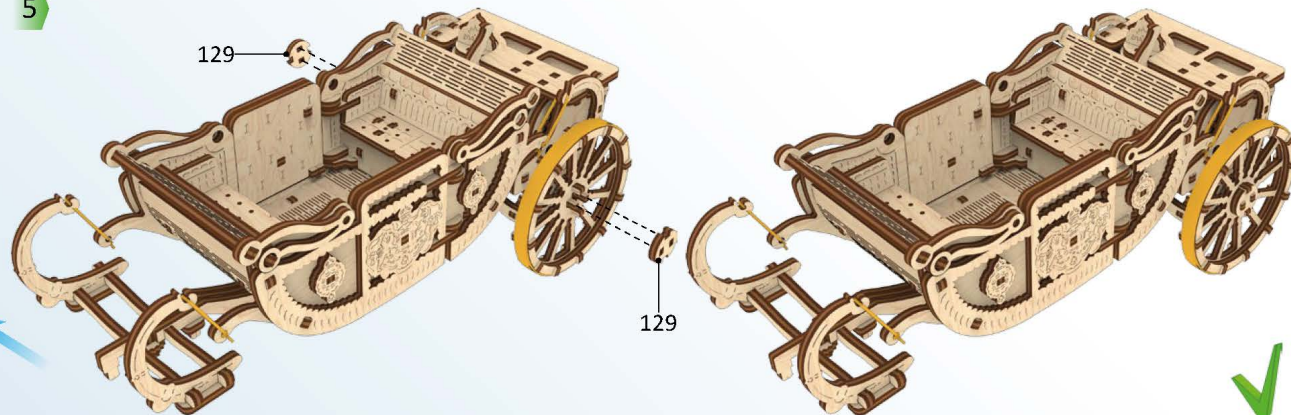

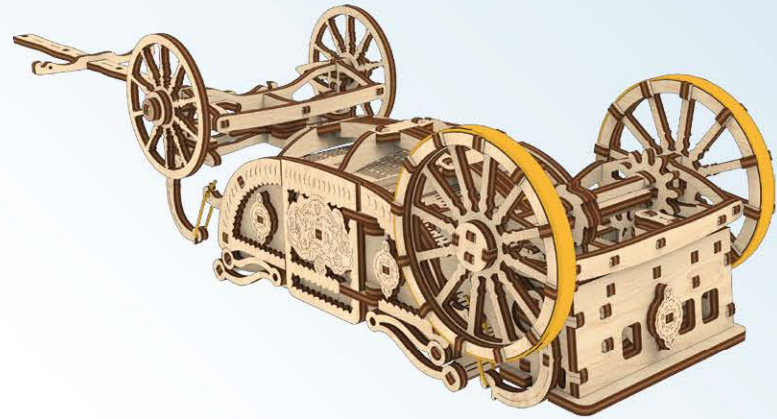
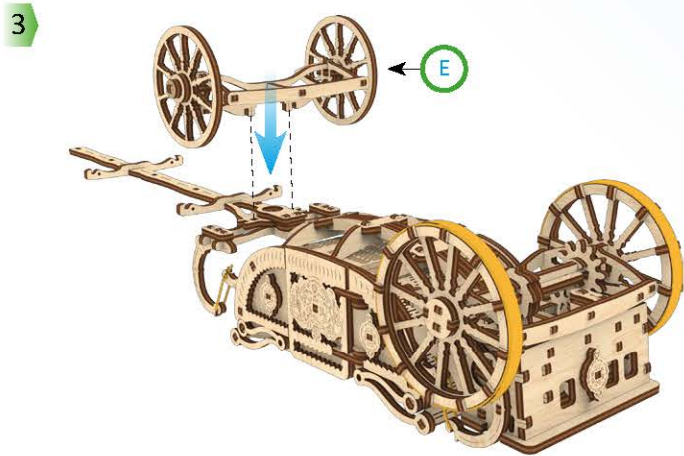
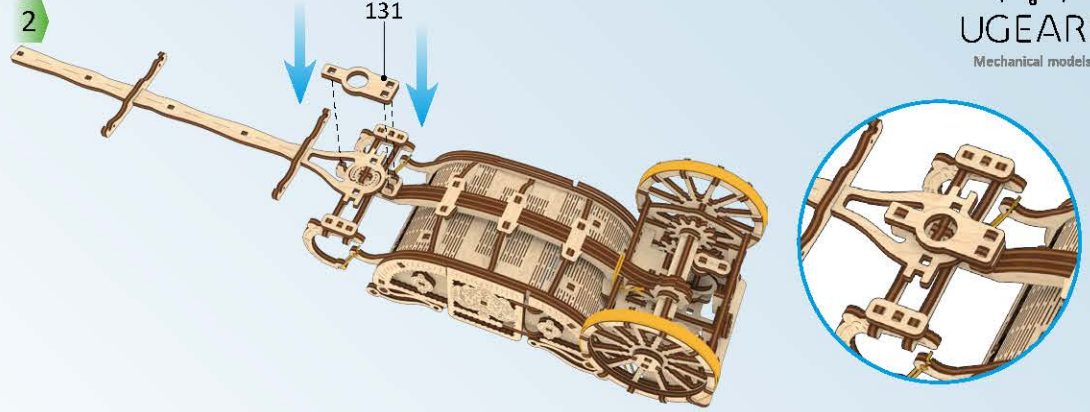
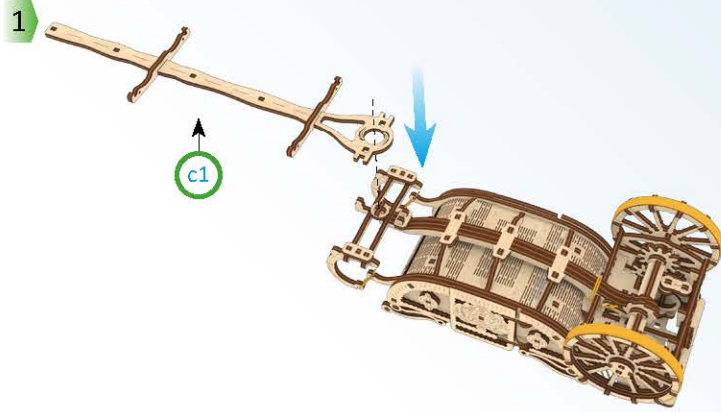
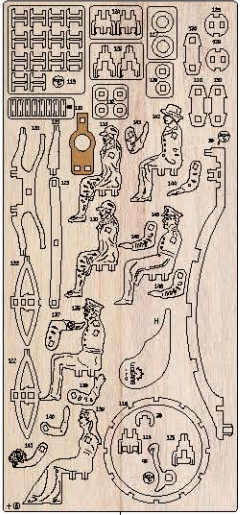

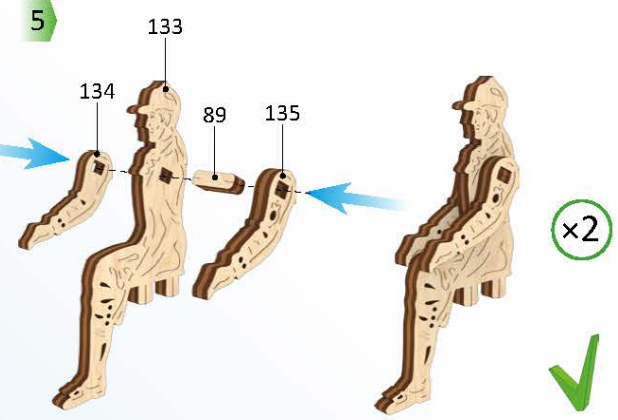
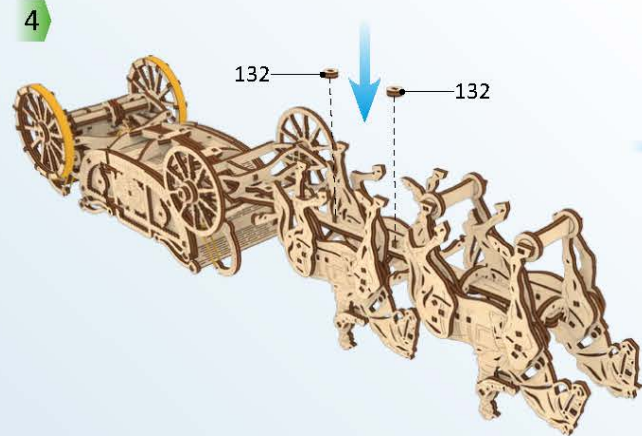
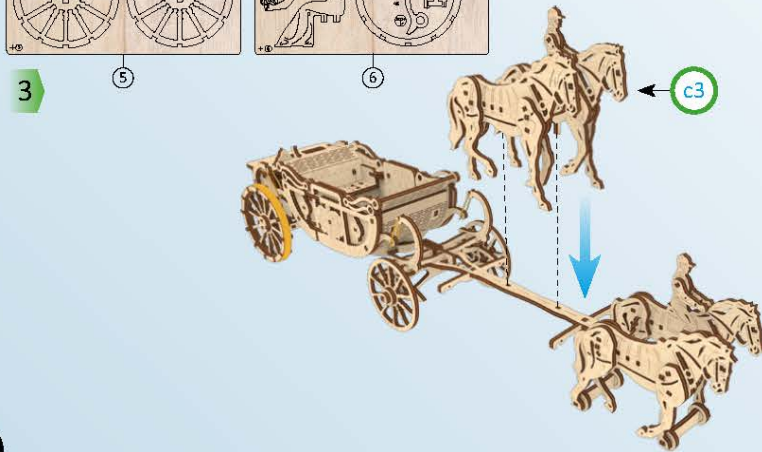
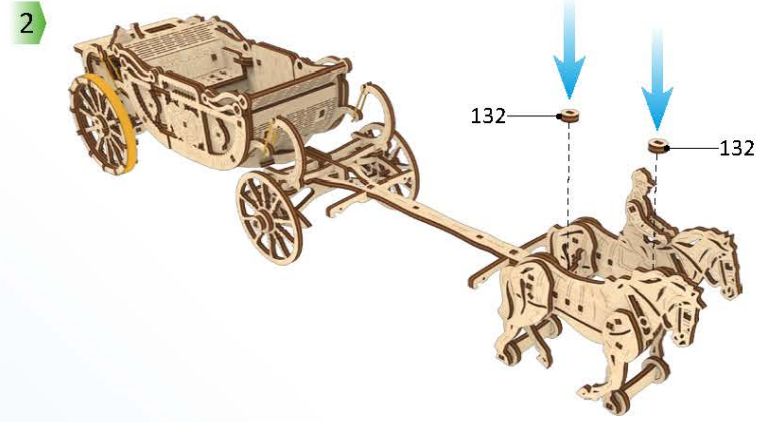
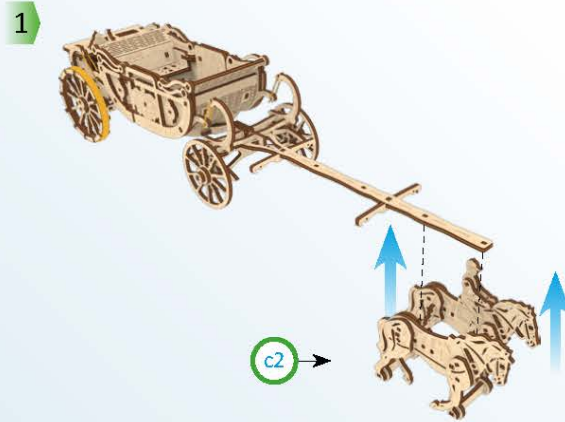
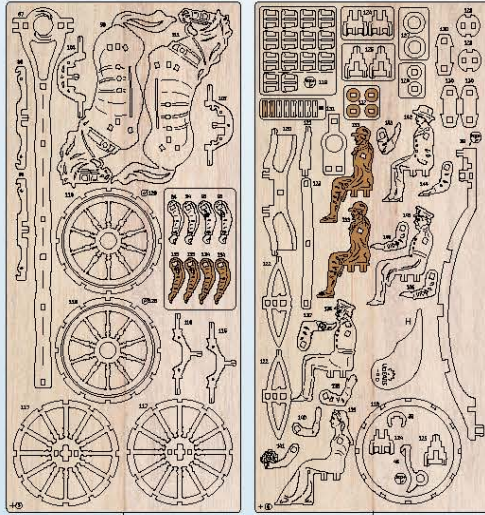

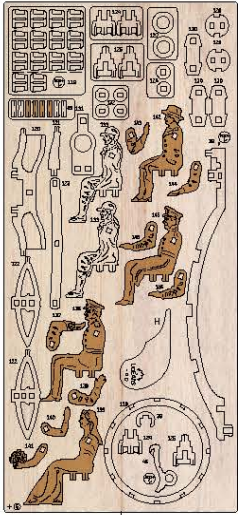

6

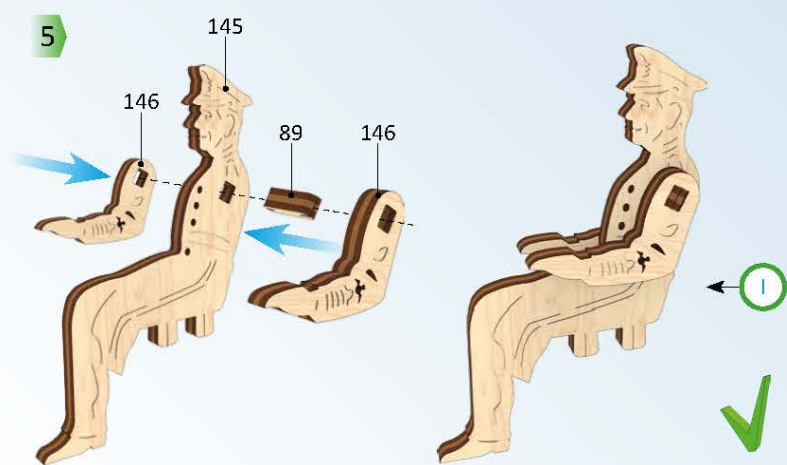
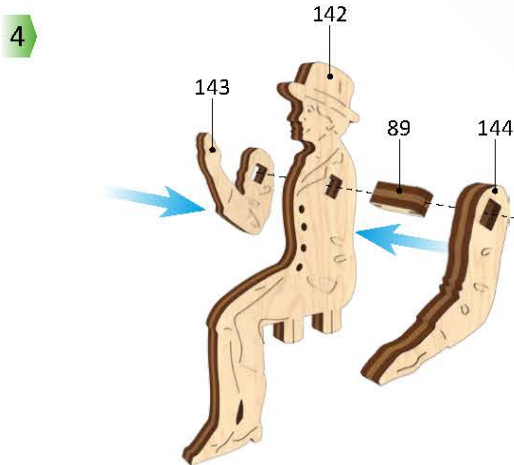
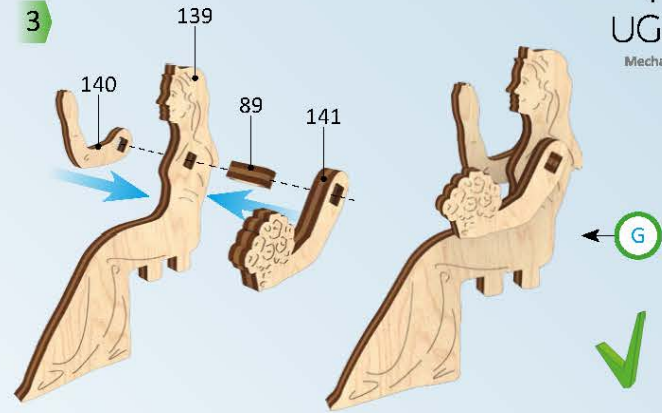
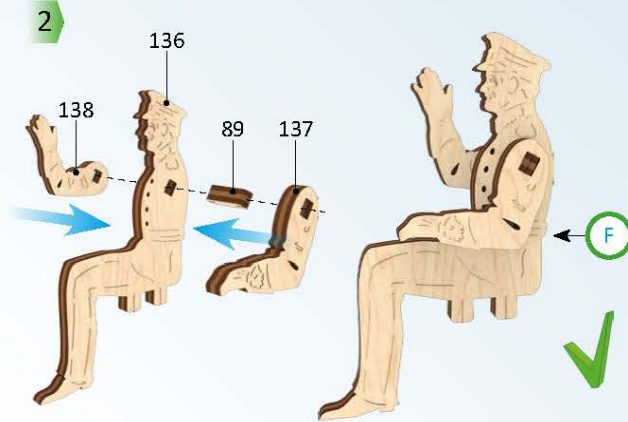
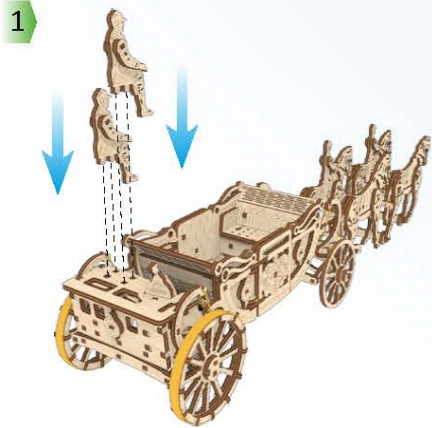

1

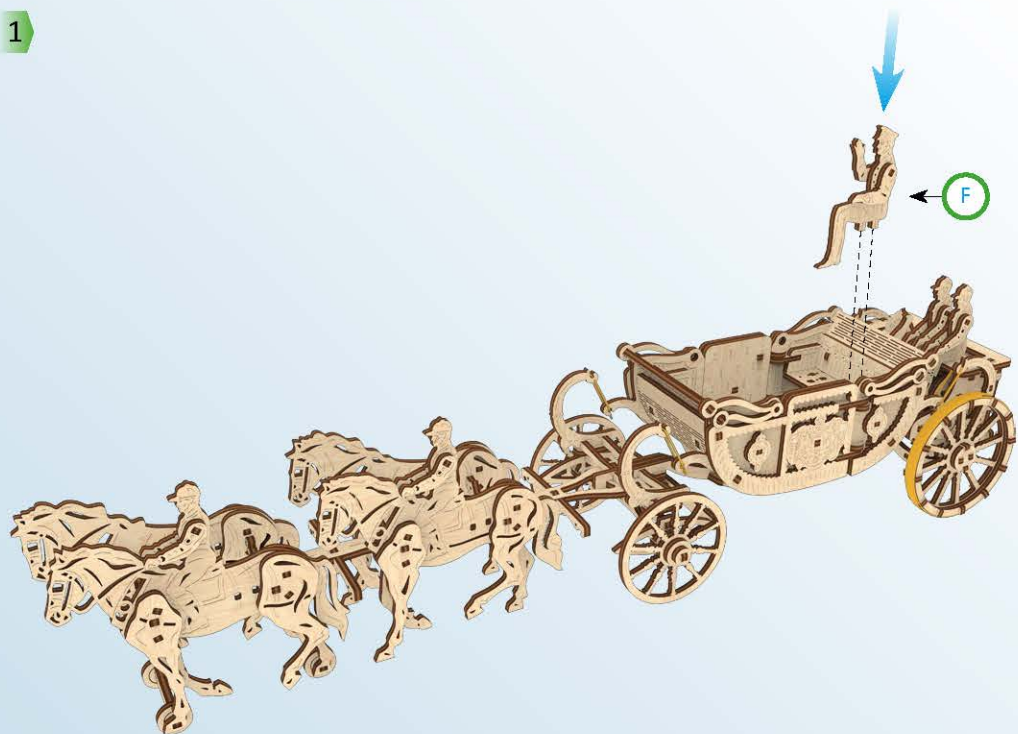

2

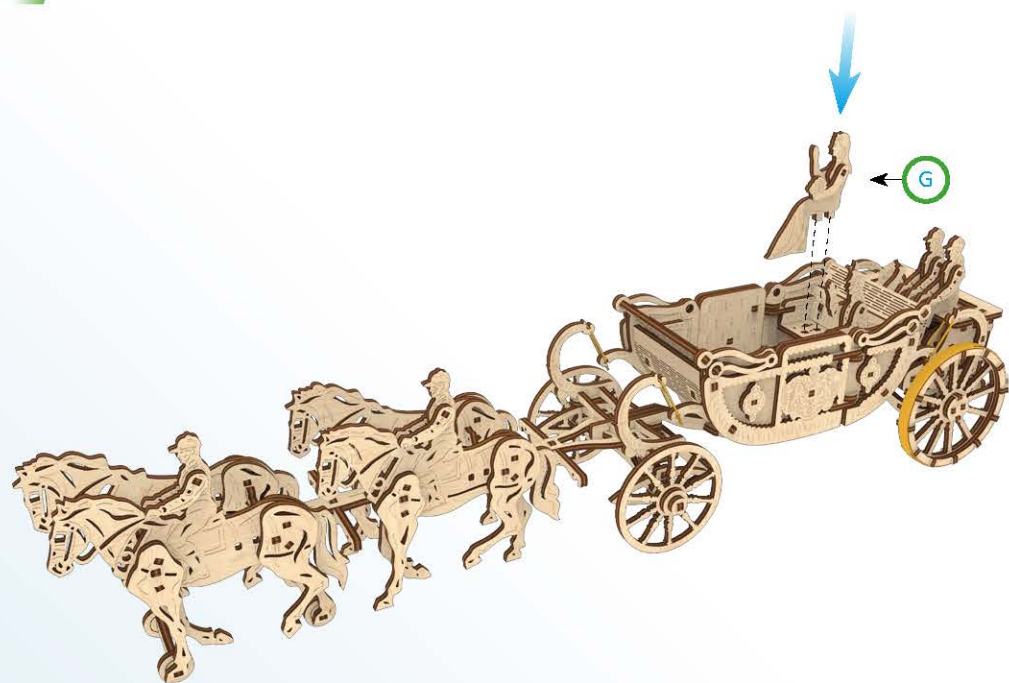



1

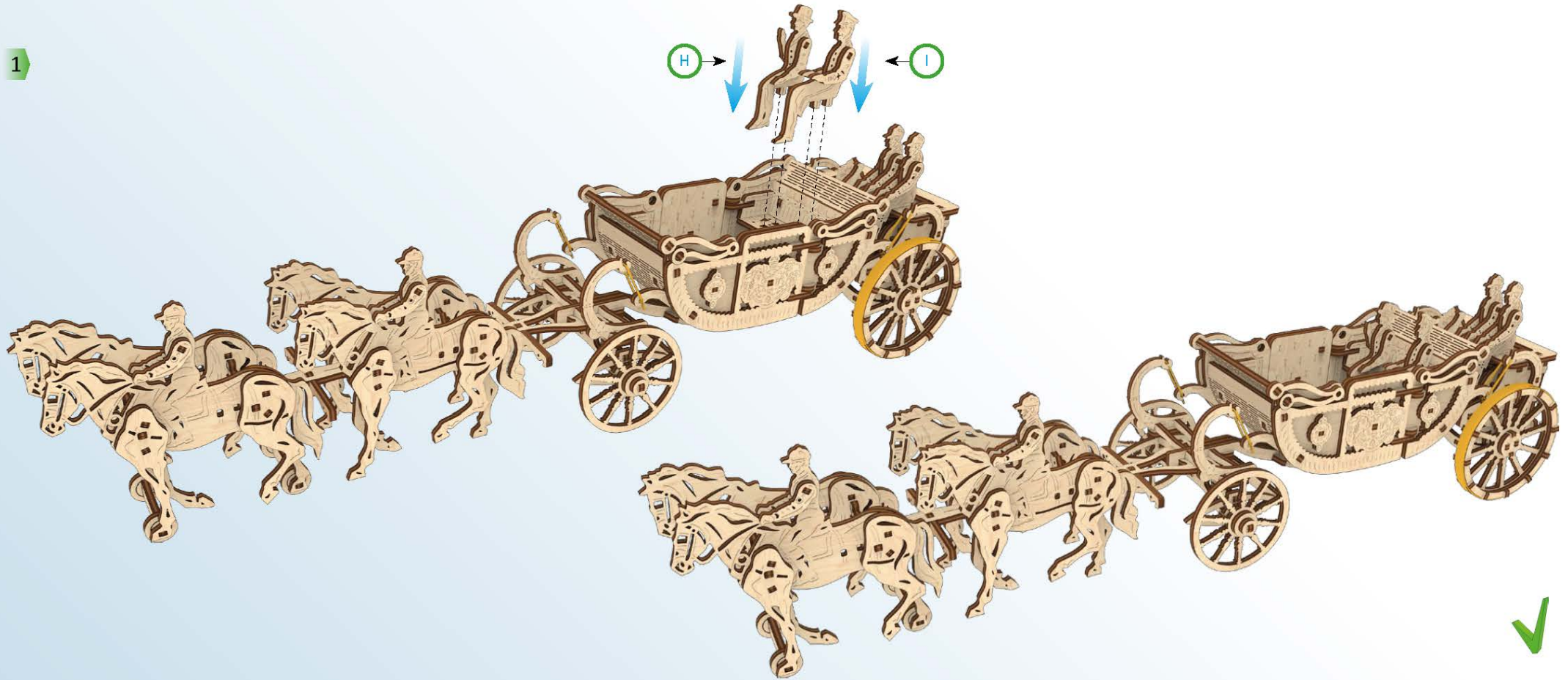

Parking

1

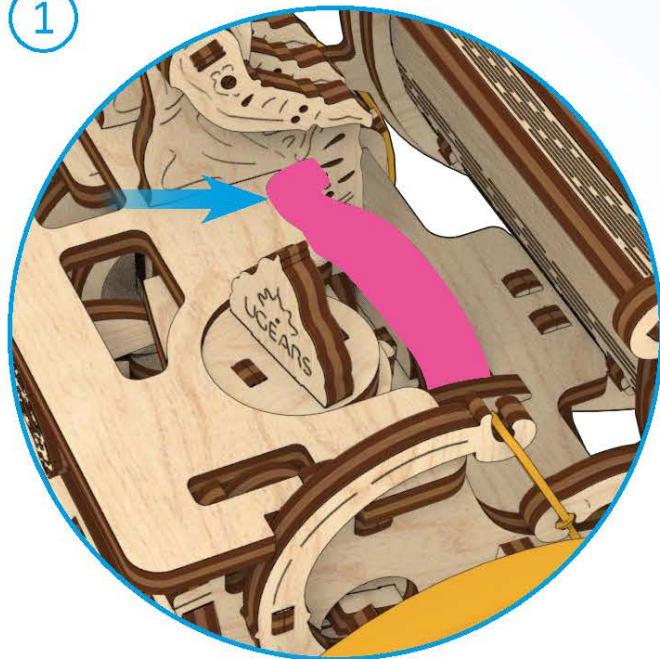

Wind up
20-25

2

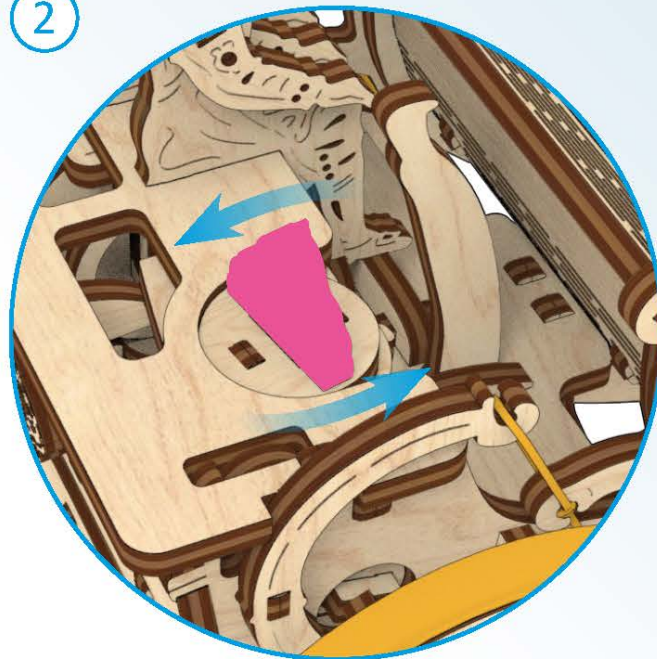

180° rev

Start

3

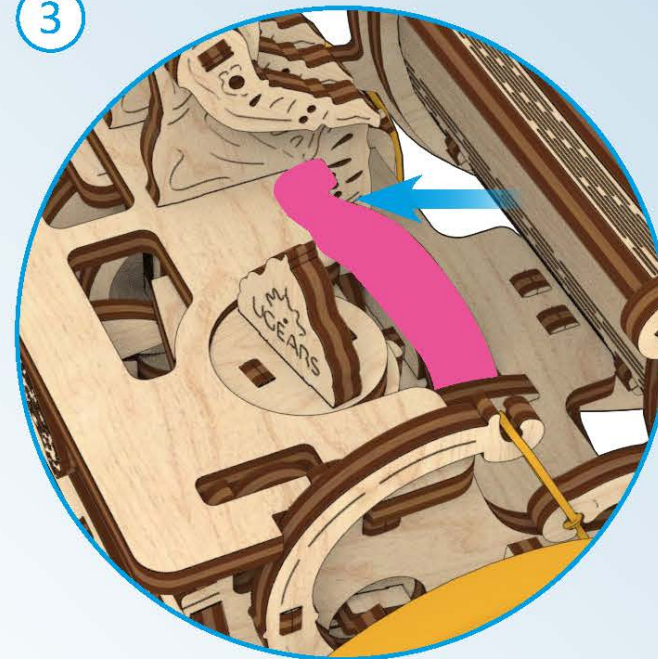



ENG Thanks for following along on this journey with us. UKR Дякуємо, що ви пройшли цей шлях з нами. DEU Vielen Dank, dass Sie diesen Weg mit uns gegangen sind. FRA Merci denous avoir accompagnés tout au long de ces étapes. POL Dziękujemy, że razem z nami pokonałeś tę drogę! SPA Gracias por haber recorrido el camino con nosotros. ITA Grazie per aver fatto uesto percorso con noi. RUS Спасибо, что вы прошли этот путь с нами. JAP UGEARSをご利用いただきありがとうございます。KOR UGEARS와 함께해 주셔서 감사합니다. CHI 感谢您参与有趣的模型配装过程。

ugearsmodels.com

ENG Customer support UKR Служба підтримки DEU Kundendienst
FRA Service client POL Wsparcie klienta SPA Servizio al cliente
ITA Servizio di supporto RUS Служба поддержки
JAP お客様窓口 KOR 고객센터 CHI 客户支持

customerservice@ugearsmodels.com