

KIT-RSRTD Installation Guide

Version 1.9

Auber Instruments, 5755 N Point Parkway, Suite 99, Alpharetta, GA 30022

e-mail: info@auberins.com Tel: 770-569-8420

www.auberins.com

This is a PID controller kit installation guide solely distributed to our clients, who have purchased the KIT-RS kit. Once you are done with this guide, please send us your feedback, comments, and/or suggestions (via e-mail to auberins@gmail.com) so that we may continue making improvements to this guide. Your help is greatly appreciated!

Note: *Please read through the entire guide before attempting any kind of installation.*

Disclaimer:

This product was created and distributed by Auber Instruments Inc. Everything included in this guide (images, text, etc.) is the intellectual property of Auber Instruments Inc. Thus, this guide is not to be replicated, altered, or sold without express written permission from Auber Instruments Inc. If you did not receive this document from Auber Instruments Inc, please let us know as it is subject to inaccuracy and/or obsolescence. The Rancilio Silvia names and trademarks are owned by Rancilio Macchine per caffè. S.p.A.

The modifications of Rancilio Silvia involve tampering with high-wattage electrical circuits in a wet environment, which could result in electric shock, burns, other serious personal injury or death, as well as fire, explosion and other property damage. This kit is for users with proper electrical safety knowledge only. Attempting to access your espresso machine will void its warranty. You, the user, will assume full responsibility for any modifications undertaken. Auber Instruments Inc is not liable for any damage caused to your property as a result of improper use.

Parts Identification.

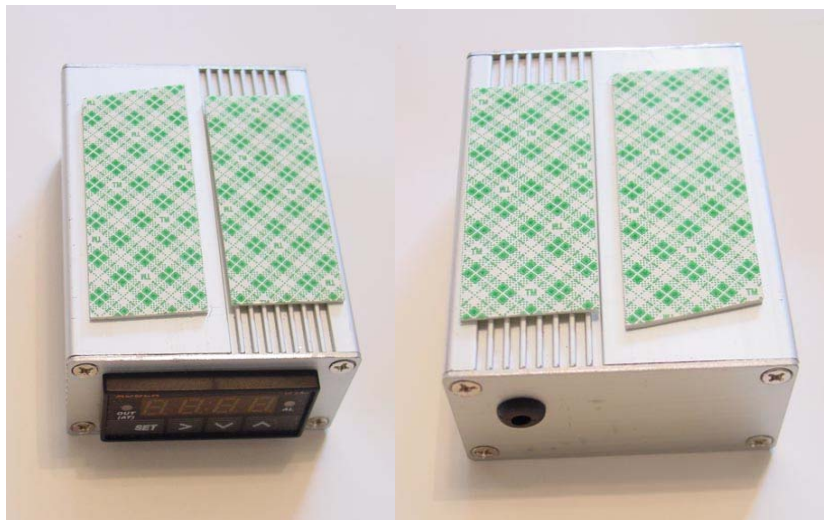

Fig 1. PID Controller, Aluminum extrusion box, rubber grommet, double sided tape pre-assembled - Front view on left. Back view on right.



Figure 2. Solid State Relay (SSR), mounting screw nut and washer for SSR, silicone heat transfer compound (white paste in the vial) for SSR and sensor, and RTD jumper cable (see D 3)).



Figure 3, Cables for connecting SSR output to heater. Terminated with spade tongue terminal on one end and tab terminal on the on other end.

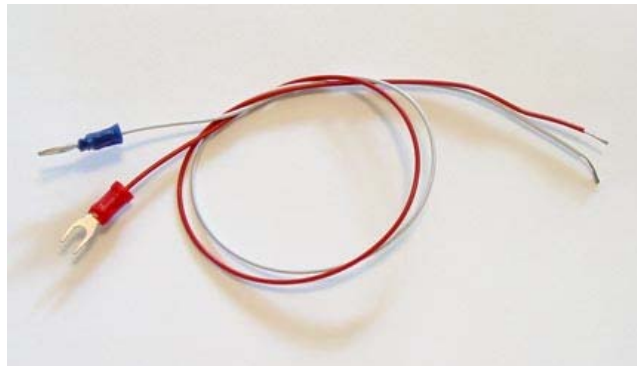

Figure 4, Cables for connecting controller output to SSR input. Red colored cable for positive. White colored cable for negative. Terminated with spade tongue terminal on one end.

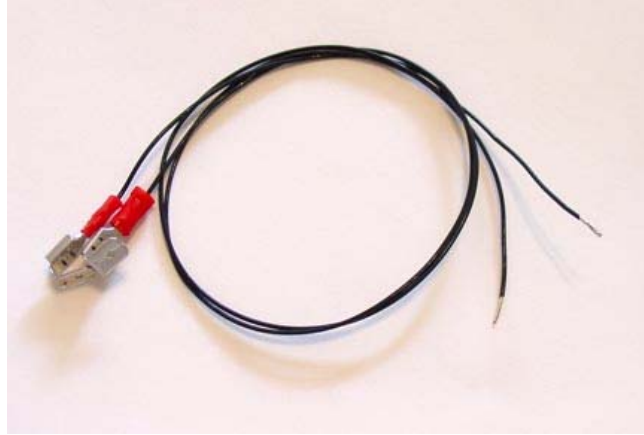

Figure 5. Cables for tapping power to controller. Terminated with piggyback connector on one end.



Figure 6, Temperature sensor (Pt100 RTD) with screw tip.

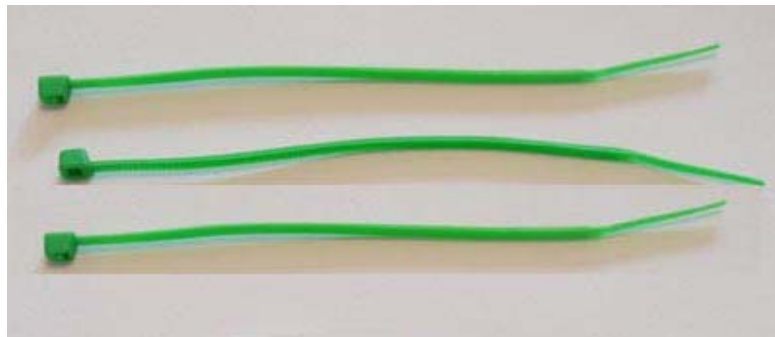

Figure 7, Cable ties

Procedure

A. Preparation for installation.

- 1) Disconnect the power cord from power outlet. Remove the water tank, portafilter, and drip tray.
- 2) Remove the splash guard after removing the screws indicated by the red arrows in Fig 8. Slide the stainless panel out from left side.



Figure 8. Red arrows indicates the screws that hold the splash guard panel.

- 3) Remove the top cover. Remove the screws indicated by the red arrows in Fig 9. Pull out the top panel.



Figure 9. Top panel. Red arrows indicates the screws that hold the top panel.

B. Install the SSR

- 1) Assemble the cables on SSR as illustrated in Fig 10a. The two red colored thick cables with soft silicone rubber insulation should be connected to the terminal marked as 1 and 2. It doesn't matter which of the two thick red cables goes to 1 or 2. The red colored the thin cable should be connected to 3 (+). The white colored thin cable should be connected to 4 (-). The clear plastic protection cover on the SSR can be removed for easy installation of the cable. Tighten the screw. Make sure the cables hold secure.

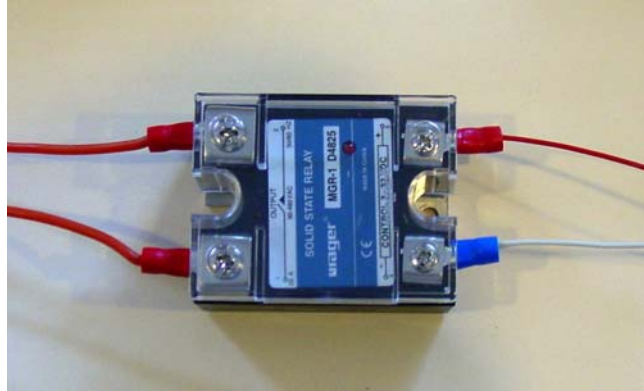

Figure 10a. SSR wiring.

- 2) The SSR is mounted on the wall behind the splash guard panel (lower right corner as shown in fig. 10b). Apply small amount of the silicone heat transfer compound to the bottom metal surface of the SSR. Mount the SSR to the screw post as shown. Use the M4 screw nut and washer supplied in the kit to hold the SSR. The M4 screw can be tighten with a 7 mm socket wrench. Use a cable tie to hold four cables in place.

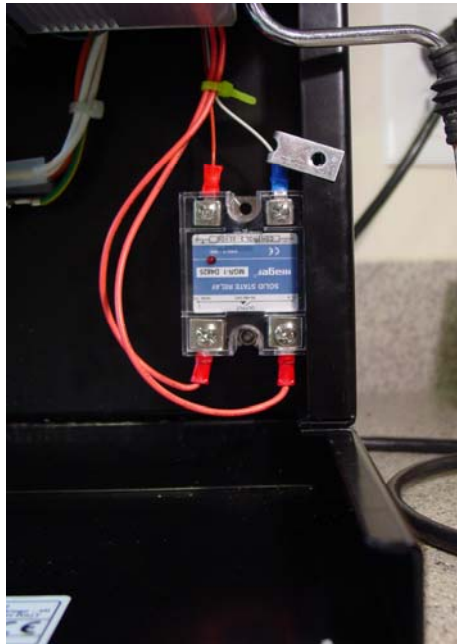

Figure 10b. SSR installed.

- 3) Install the splash guard panel back to its original position (figure 8 above). Feed the two SSR output cables into the boiler compartment. Feed the SSR input cables (the thin red and white ones) to the outside through the space around the steam wand (Fig 16 below)

C. Installation in boiler compartment

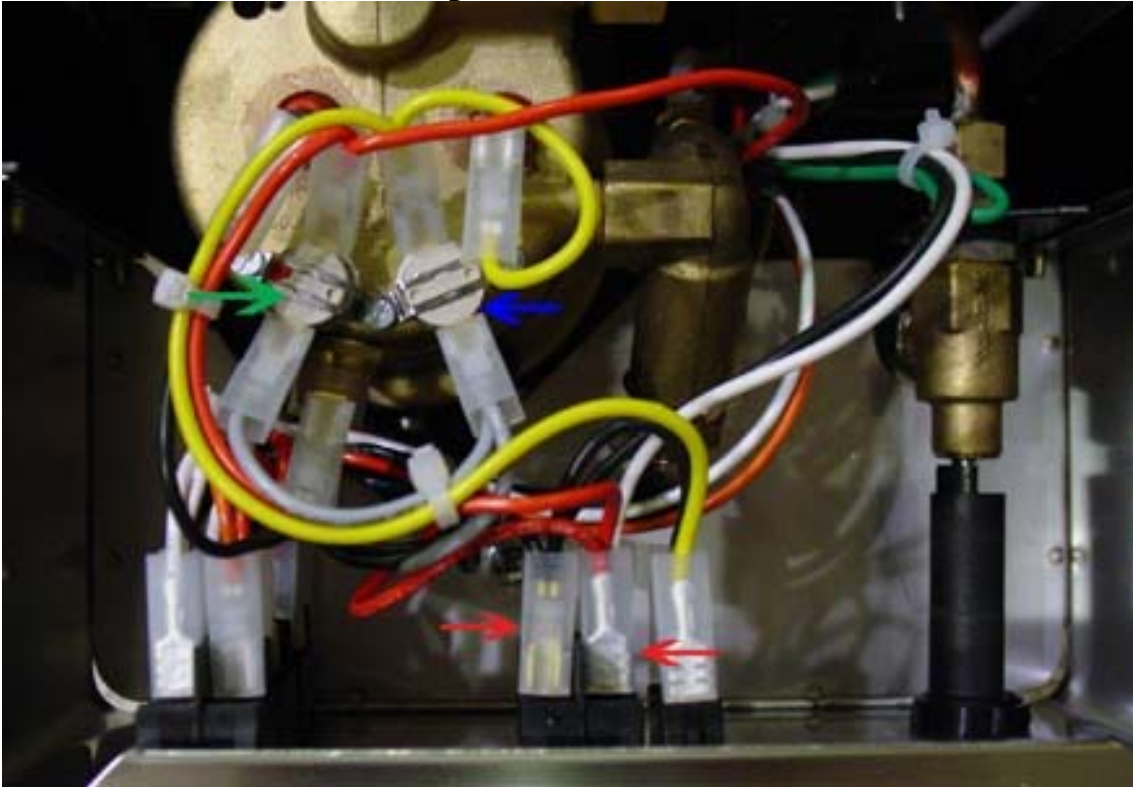

Fig 11, top view of original wiring. Red arrows indicating where the controller power cable will be tapped. Green arrow points to brew water control thermostat. Blue arrow points to steam temperature control thermostat.

- 1) There are two thermostats on top of the boiler. The one on left with a red dot on top is the brewing water temperature control thermostat (marked with green arrow). The one on the right is for controlling the steaming temperature (marked with blue arrow). You need to remove the cable connectors on both side of brew water temperature thermostat (connectors with red and gray cable). They need to be connected to the output cable of SSR (after the RTD sensor installation). You also need to remove this thermostat and move the steaming thermostat to its position. This is because you need to mount the RTD sensor to the thermowell underneath the steam temperature control thermostat. This thermowell is closer to the cold water inlet, and result in better control. Moving the steam thermostat to the brewing thermostat position is slightly more difficult to do than the other step. You need to use a small to medium sized flat head screw driver to remove the screw. Be very careful to not let it drop into the gap below. If it drops to the top of the grouphead, it could be a lot of trouble to take it out. A magnetized screw driver will help. Sometimes, it is convenient to work on the screws by temporarily removing the cable connector on the right side terminal of the heater. Please note that if the machine is old and as a result, the plastic protection guard of the heater connector is brittle, it might break off and leave some unprotected spots. In that case, we suggest not removing the

cable on the heater. Fig 12 shows the steam thermostat has been relocated and thermowell for RTD sensor is exposed (marked with red arrow).

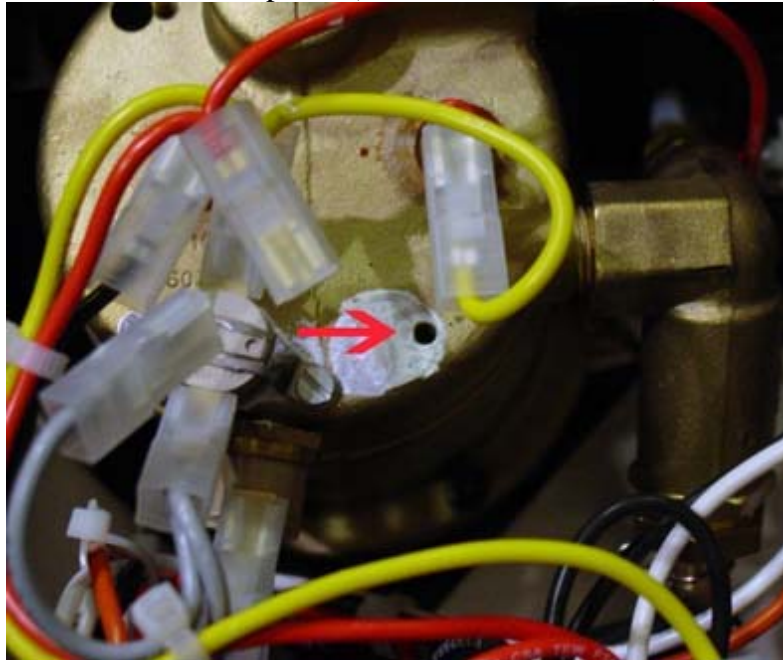

Fig 12, Thermowell for RTD mounting

- 2) Install the RTD sensor. **Caution:** the connection between the RTD and cable is very fragile because of the small size and there is no strain relieve. To prevent the sensor from breaking, install the sensor without unwrapping the cable (install it as the way it was received). This will reduce the twist pulling force when screwing on the sensor. The sensor can be tightened with a small wrench or pliers. It does not need to be very tight. (If you want make sure the sensor didn't get damaged during installation, you can measure the resistance of the sensor after installation. It should be in the 100 to 140 ohm range).
- 3) Install the cable from SSR output (the two thick red wires) to the gray and red connector. Fig 13 shows what it should look like at this step. Do not tie up the cables up at this time because you will need the flexibility for the controller connection.

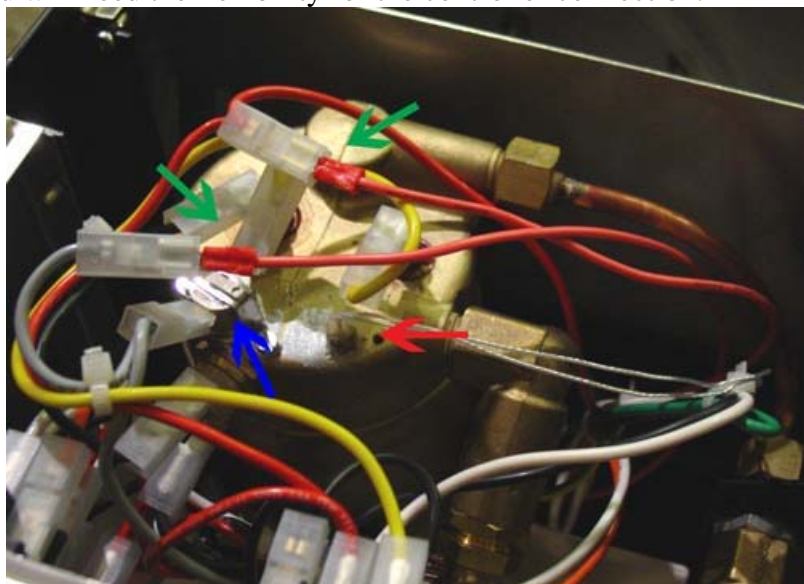

Fig 13. Wiring for SSR output and RTD sensor. Red arrow points to RTD sensor. Green arrows point to the SSR output connections (the new insulated connects look slight different). Blue arrow points to the steam thermostat.

- 4) Tapping the controller power line to the espresso machine. The power for the controller is tapped from the main power switch by using a piggyback connector on the black cable. Remove the connector with black and red cable (red arrows on fig 15). Remember the original position: the connector with black cable should be on the left and connector with red cable in the center). Slide the two controller power cable piggyback connectors on to the switch as shown in Fig 14. The tab on the piggyback connector should be on the top. You might need to bend it downward a little bit if the angle is too high. There is no difference between the two black colored cables. After installing the connector, connect the cables that were just removed to the tab on the piggyback connector. It is very important to keep the original position, black on the left and red in the center (Fig. 15),

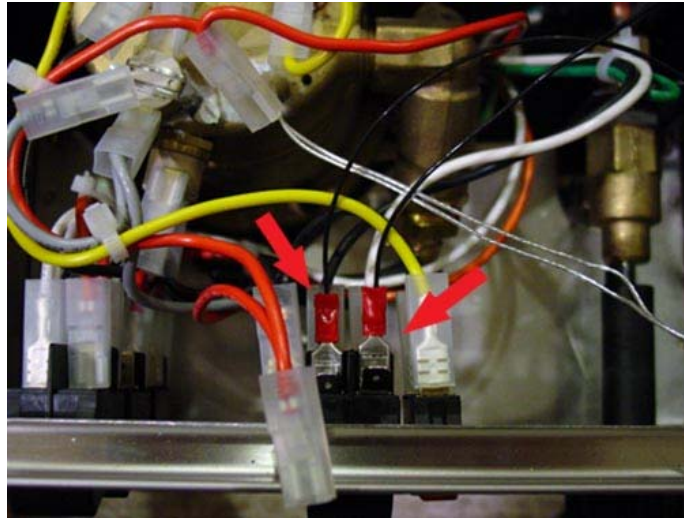

Fig 14. The controller power cable piggyback connector location (red arrow).

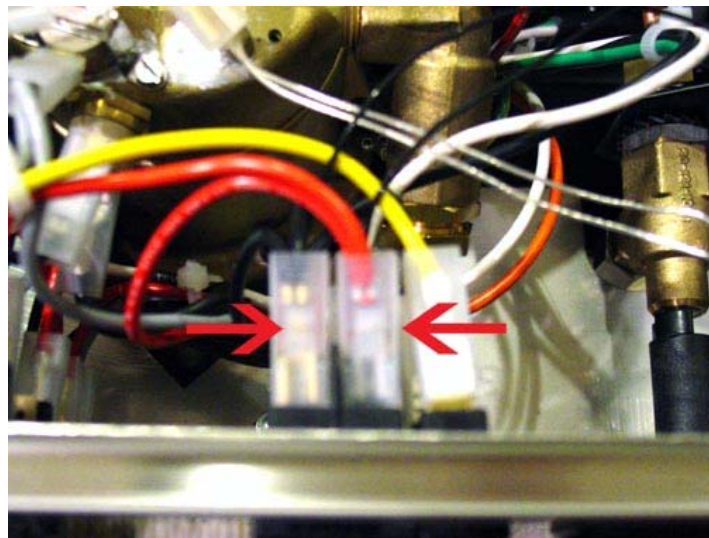

Figure 15. Put the original power cable back.

D. Connecting the controller.

- 1) Remove all 8 screws on the controller box. Save them in a safe place.
- 2) Fit the controller power cables and RTD sensor cables to the outside through the gap around the steam wand (red arrow in Fig. 16). Collect the SSR control cables from the back of the splash guard pane. Fit all cables through the rubber grommet on the back panel of the controller box. Make sure the direction of the back panel is as shown in figure 16. The surface with countersunk screw hole is the outside surface. Cables should come from the outside surface to the inside. You need to fit the cables through the grommet one at a time. There are six cables total.

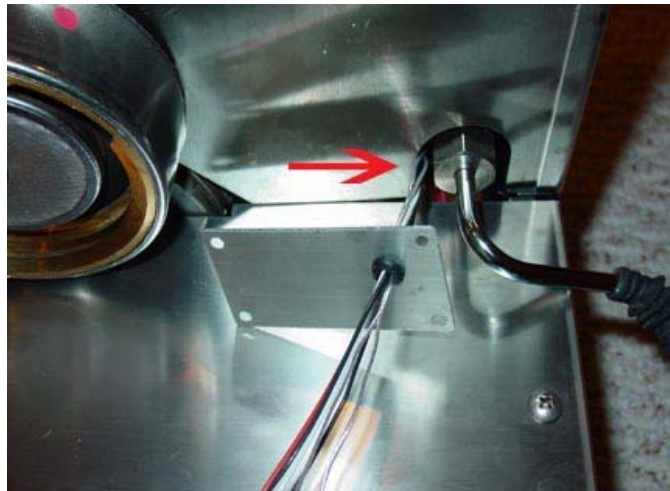

Figure 16, Cables going through the back panel of the controller box.

- 3) Feed the cables through the controller box. Connect them to the controller as shown in Fig 17. Wiring the controller correctly is very critical step. Failure to install it correctly can cause damage to the machine and electric shock. The terminal numbers are printed on labels located on both sides of the controller. The black colored power cables need to be connected to terminal 1 and 2. SSR input cable has a polarity. The red colored cable from SSR has polarity (+) and is connected to terminal 10; and the white colored cable is connected to terminal 9. The RTD cable needs to be connected to terminal 7 and 8. The white colored RTD jumper cable needs to connect to terminal 6 and 7. The detail is shown in Table 1 and Fig 16b.

Table 1. Wiring to the controller

Color code of wire	Terminal
Black power cables	1 & 2
White RTD jumper cable	6 & 7
Clear RTD cables	7 & 8
White cable from SSR	9
Red cable from SSR	10

Bending the wire tip will make the insertion of the cable easier as shown in Fig 19. In order to prevent the cables from coming loose when pulling on them during box installation, make sure all cables are securely tightened by a screw driver. Also, make sure there are no small wires touching the other terminals, causing a short circuit.

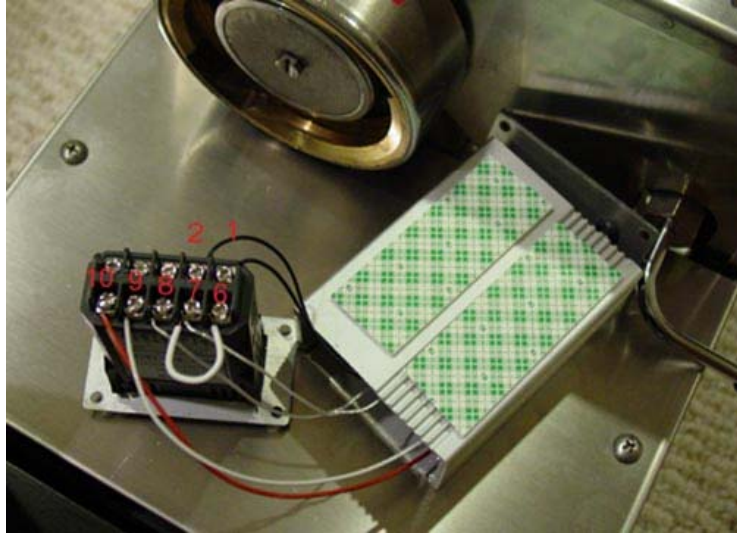

Figure 17. Wiring the controller.

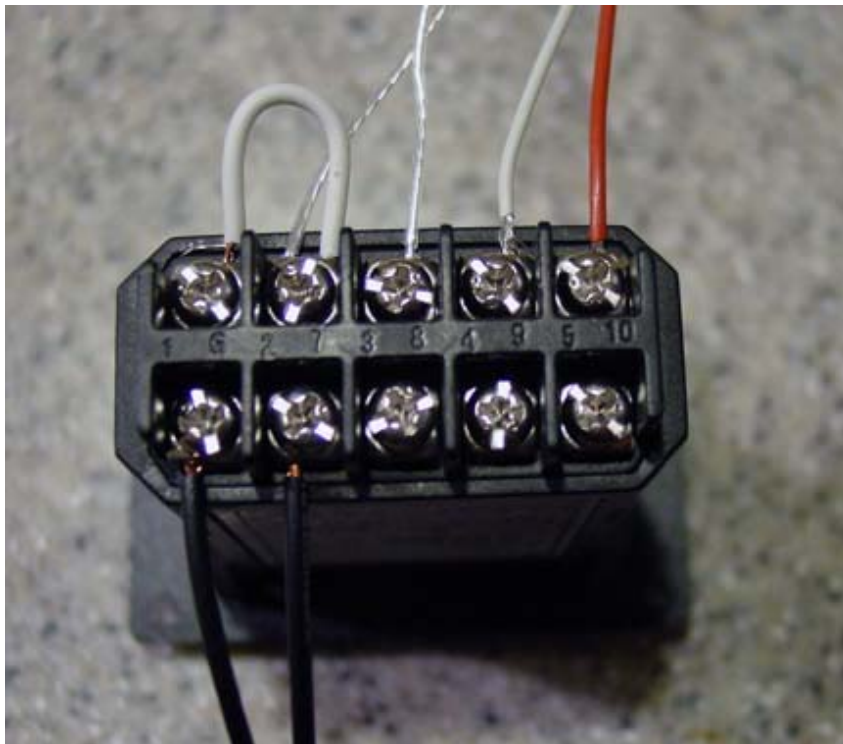

Figure 18, Detailed view.

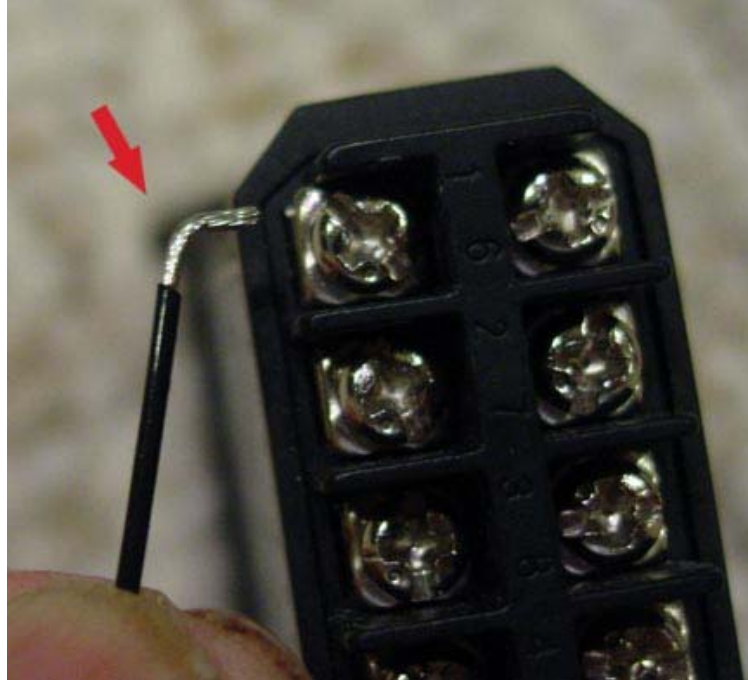

Figure 19. Bend the wire for easier to insert.

4) Install a cable tie as strain relief

Place a cable tie at 2 to 3 inches away from the back of the controller. Cut off the tail of the tie. This tie will function as strain relief to preventing the wire being pulled off the terminal.

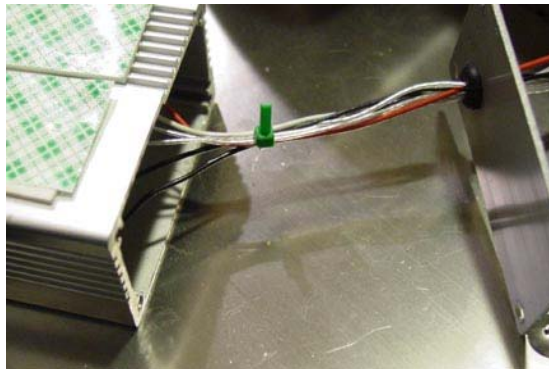

Figure 20, Install a cable tie as strain relief.

- 5) Install the controller to the box. Screw the front panel first. Make sure the surface of the box with double sided tape is on top of the controller. Then, gently pull out the cable from the back panel of the box until it is stopped by strain relief. Screw on the back panel. Make sure the rubber grommet is on the right upper corner (viewing from front) position as shown in Fig. 21.

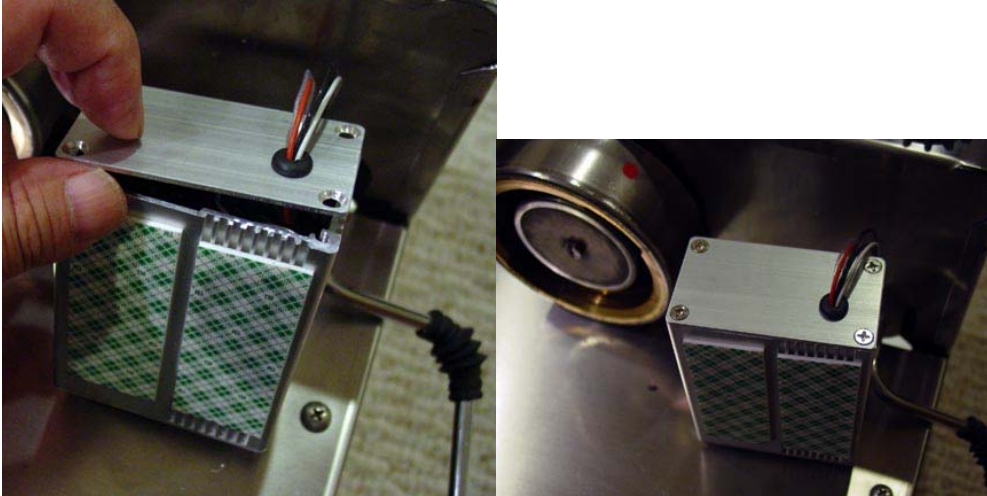

Figure 21. Left, press the back panel on with a little force. Right, screw is on.

- 6) Clean the controller box mounting area on the espresso machine with cotton ball soaked with alcohol to ensure a good adhesion of the box. Fig 22. This is very important because the metal surface might contain oil that reduces the bonding strength of the tape. When properly installed, 3M double tape is very strong and durable. It has been used for industrial use such as in building structures and automobile parts.



Figure 22. cleaning the box mounting area with alcohol.

- 7) Remove the protection film on the double side tape on the box. Slowly and carefully mount it on the espresso machine. Make sure there is a gap between the group head and box as shown on Fig. 23. It is ok to let the box touching the steam wand holding nut. You have only one chance to put it in the right position. If you remove it and try to put back again, the bonding will not be as good.



Figure 23. Control box position.

- 8) Tie up the wire in the boiler compartment (Fig.24). Make sure there are no cables touching the boiler surface. This is especially important for the cables installed by the factory. The cable installed by factory has PVC insulation that will melt when touching the hot boiler surface. It can result in electric shock.



Figure 24. Tie up the cables.

- 9) Before re-installing the top cover, cut the excess tail of the cable ties. Check all connections that have been changed. Make sure that there are no exposed wires or connectors that will touch the top cover metal when it is installed. Some of the cables that stayed above the level of the cover when fitted will move when the cover is installed. If that cable has an exposed metal connector, it could result in an electric short.
- 10) Install the water tank.
The project is done. This is how the machine should look like now.



To use the machine, please read “Operation manual for Rancilio Kit”.

Appendix

1) Circuit diagram of Silvia.

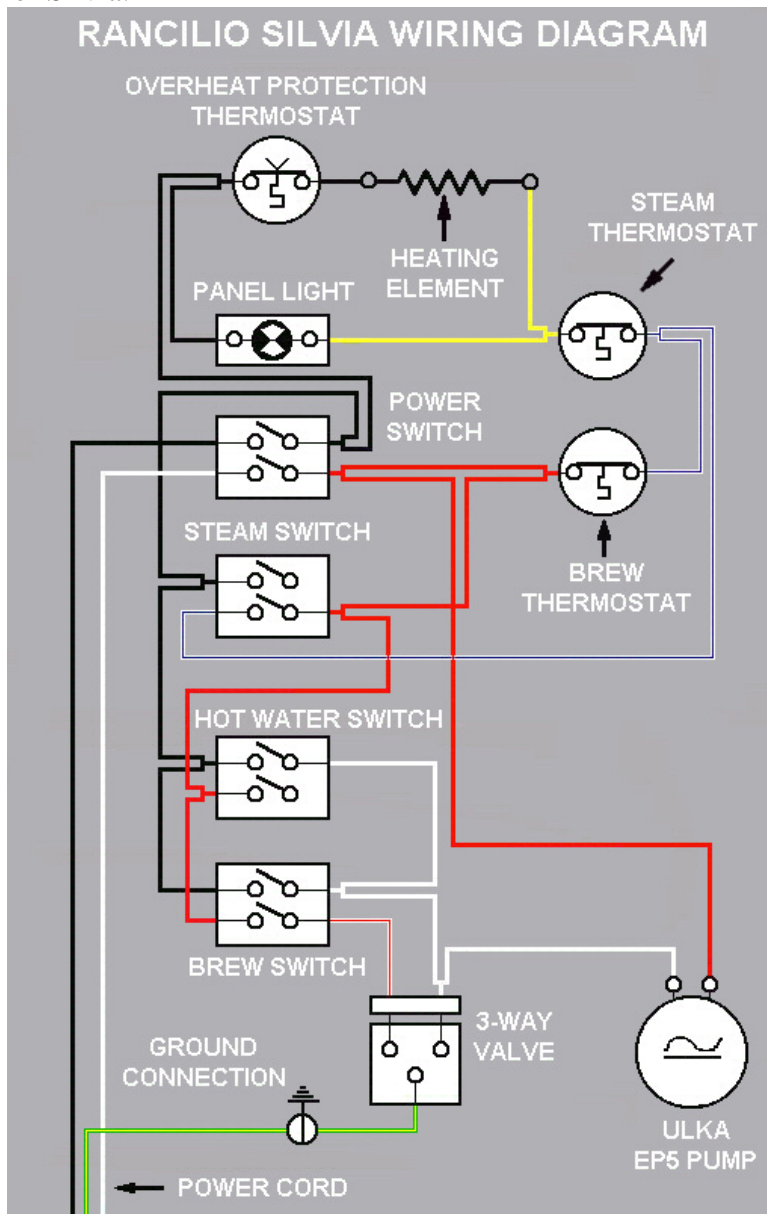

2) Circuit diagram of Silvia with the KIT-RSRTD connection

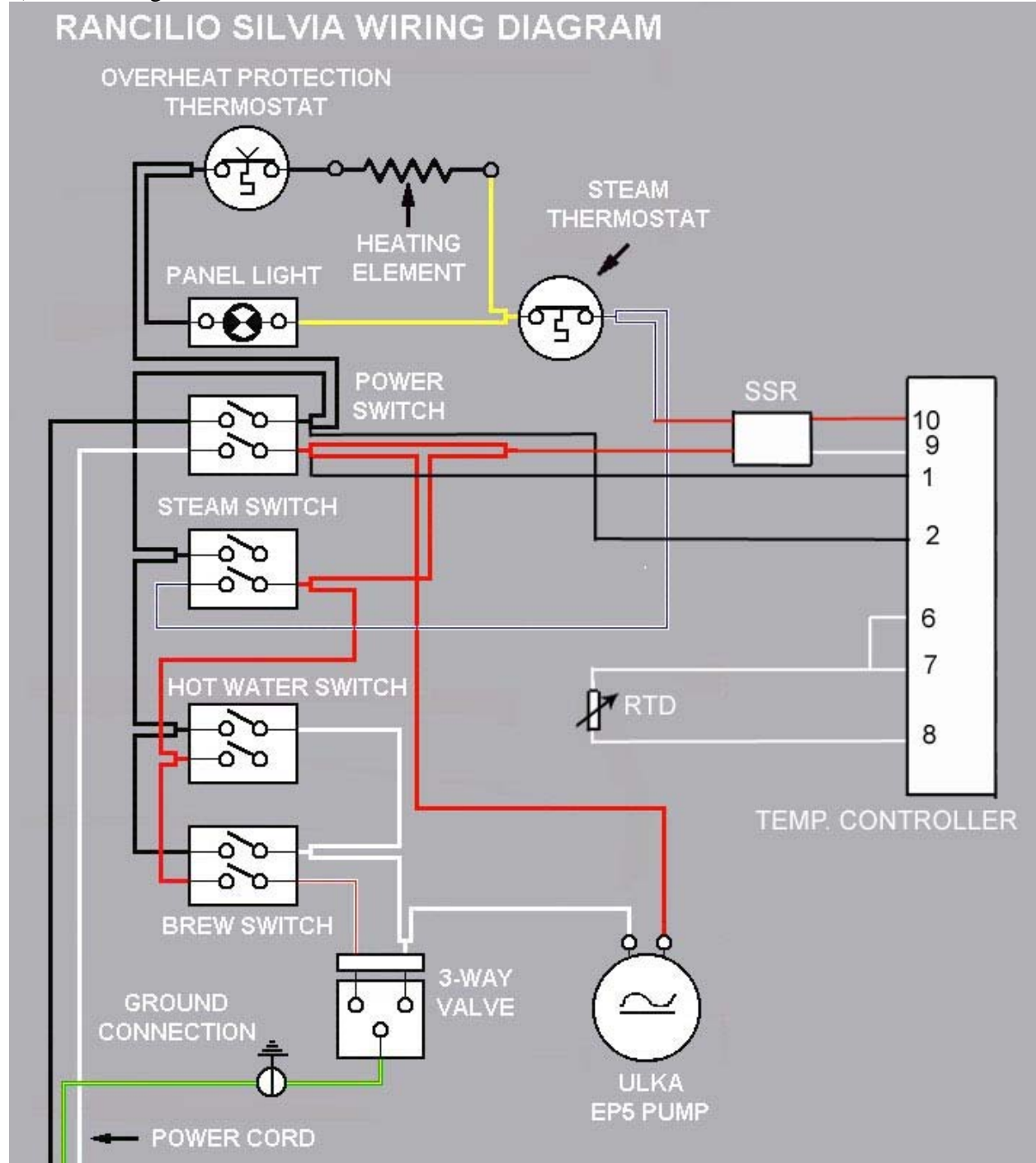

3) Useful link.

<http://www.murphyslawonline.com/silvia.html>

<http://home.surewest.net/frcn/Coffee/Coffee63.html>