

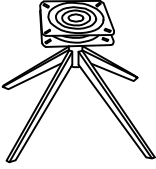



 ① x1	 ② x1	 M6x25 A x10	 M6x16 B x2	 Ø16 C x12	 4# D x1
---	---	---	---	--	---	---



Left  ③ x1	Right  ④ x1
--	---

Step 1

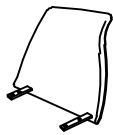
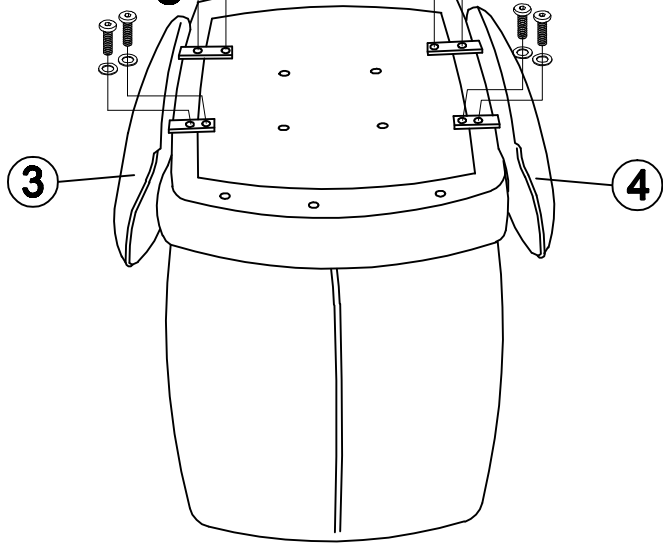

Step 2

