

LED Pole Light

With Photocell

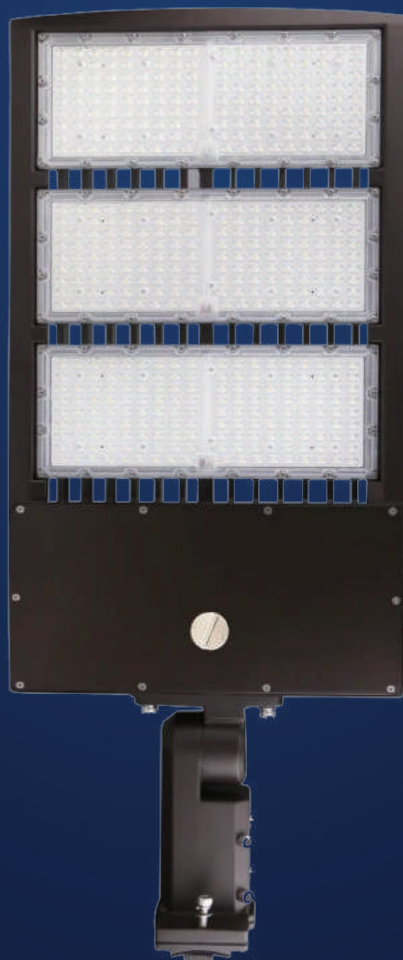



AM



A&D



YM



DM



FM

P/N:WEN -S-G07-450WCT3B2-abcdef

Note:

Where "a" can can any two letters represent lamp colors; "BH = Black 、 WH=White 、 BR=Brown or Customized"

"b" can be "3RP", "3NP", "5RP", "5NP", "7RP" or "7NP" for Photocontrol type provided or blank for no Photocontrol provided;

"c" can be "10SP" or "20SP" for Surge-Protective Device type provided or blank for no Surge-Protective Device provided;

"d" can be "M" for Motion Sensor type provided or blank for no Motion Sensor provided;

"e" can be "AM", "DM", "YM", "A&D" or "FM" to represent mounting bracket types;

"f" can be any two-digit number to represent CCT. "40=4000k、 45=4500k、 50=5000k、 57=5700k"

DIMENSIONS

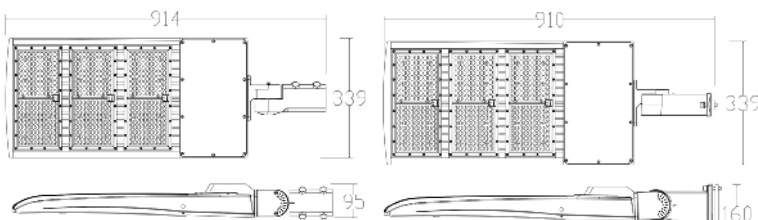

AM

DM

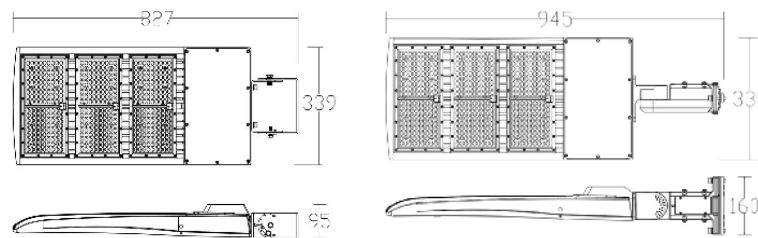

YM

A&D

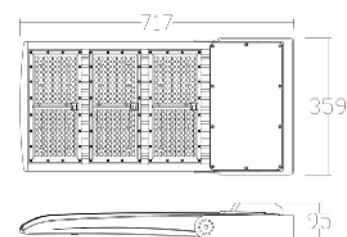

FM

ADVANTAGE

- UL cUL DLC certificate.
- Seoul Chip, high CRI.
- IP65 driver, input voltage 100-277VAC.
- Output constant current lever can be adjusted through output cable with 1-10V.
- No UV or IR in the beam.
- Easy to install and operate.
- Energy saving, long lifespan.
- Light is soft and uniform, safe to eyes.
- Instant start, NO flickering, NO humming.

APPLICATION

- Outdoor basketball court, tennis court.
- Badminton court, the football field.
- The school playground, stadium.
- Community leisure entertainment plaza, road lamp etc.

SPECIFICATIONS

OPTICAL	Input Power	450W
	Lumen	54000-60750LM
	Lumen Efficacy	120-135LM/W
	Color Temperature	4000K, 4500K, 5000K, 5700K
	CRI	>80
	Viewing Angle	150*85 Degree (Type III)
ELECTRICAL	Input Voltage	100-277VAC 50/60Hz
	PF	≥0.9
	THD	≤20%
	Driver Model	China Brand Driver SS-240VA-56B*2
	Optional Accessory	Photocell / Surge protector/ Motion sensor
MATERIALS	LED Brand	SEOUL
	LED Type	SMD3030
	LED QTY	462PCS
	Housing	Aluminum Alloy
	Housing Color	Black / Brown/white/Customized
	Waterproof Rating	WET (IP65)
OTHERS	Operating Temperature	-40°C TO 45°C
	Operating Humidity	10%-90% RH
	Storage Temperature	-40°C TO 80°C
	Storage Humidity	10%-95% RH
	Warranty Time	5 Years

PACKAGE

Stent Type	Lamps Net Weight	Size	Qty/ Carton	Weight/ Carton
AM	11.5 KG	1015x 395 x 165mm	1	12.7KG
DM	12KG	1015 x 395 x 165mm	1	13.2 KG
YM	11.2KG	1015 x 395 x 165mm	1	12.4KG
A&D	12.3KG	1015 x 395 x 165mm	1	12.5KG
FM	12.5KG	1015 x 395 x 165mm	1	12.7KG

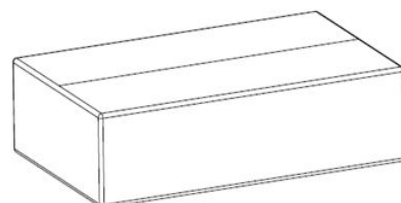
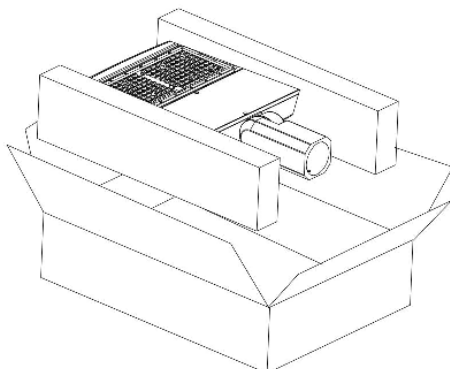

LIGHT DISTRIBUTION TESTING PARAMETERS

Luminaire Property

Luminaire Manufacturer:
Voltage: 120.3 V
Power: 450.65 W

Current: 3.7629 A
Power Factor: 0.998

Photometric Results

IES Classification: Type III
Total Rated Lamp Lumens: 55150.0 lm
Efficiency: 100%
Upward Ratio: 0%
Central Intensity: 13777.86 cd
Pos of Max. Intensity: H157.5 V68

Longitudinal Classification: Medium
Measurement Flux: 55150 lm
Downward Ratio: 100%
Luminaire Efficacy Rating (LER): 122.38
Max. Intensity: 18879.82 cd

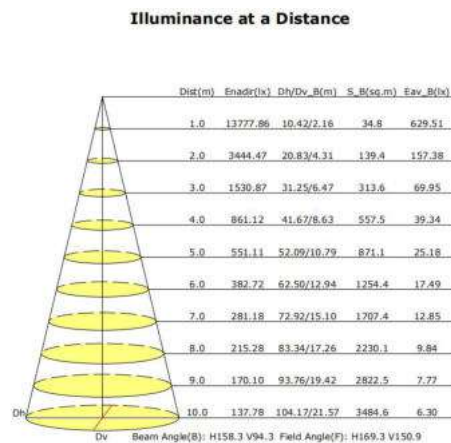
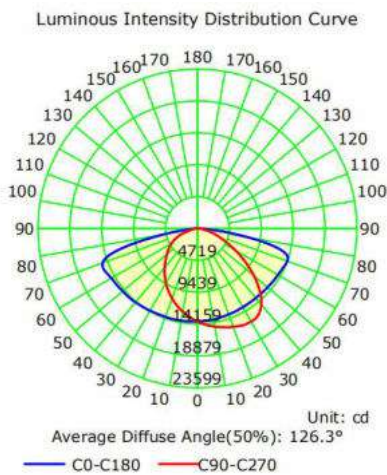

NOTICE FOR USER

- Please turn off power before install or change assembly parts.
- The input voltage and lamps should be matched, after connecting the power line, Please make sure the wiring section is insulated.
- No-professionals, must not install and disassemble the lamps.

TROUBLE SHOOTINGS

Troubles	Check points
Flickering of the light	Turn off the power and turn on again in 3 minutes. If same phenomena occur, then call agencies.
Out of working	Please check the connection.