

D Series

LED Explosion Proof Light



Standard Materials:

- ◆ Housing: Copper-free aluminum
- ◆ Lens: Tempered glass
- ◆ Hardware: Stainless steel
- ◆ Mounting Bracket: Stainless steel
- ◆ IP66

Key Features:

- ① Dimmable and battery backup function is available.
- ② High-quality SMT LED and Meanwell driver.
- ③ Heavy-duty and high impact resistance.
- ④ Replaceable LED board and drivers.
- ⑤ Integrated junction box for driver.
- ⑥ Marine rating powder coated finish treatment.
- ⑦ Various installation ways for different applications.
- ⑧ Glass lens or polycarbonate lens for making different beam angles.

Additional Features:

- Emergency battery backup is available.
- 5-year warranty.
- Low temperature applications to -40°C (-40°F) and high temperature up to 55°C (131°F).

Photometry:

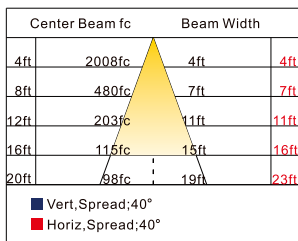

40°

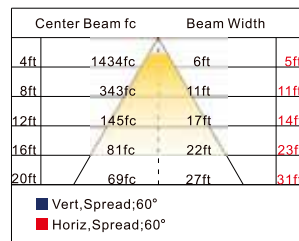

60°

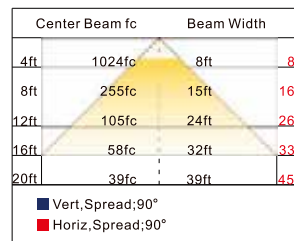

90°

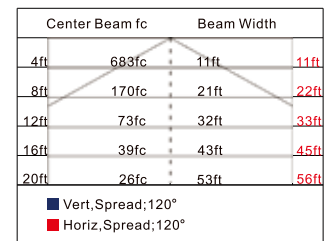

120°

Technical Data:

Model	Wattage	Operating Voltage	Lumens (lm)	Efficacy (lm/W)	CRI	CCT	Emergency Time
EX-20W D2YZDA	20W	AC100-277V/200-480V or DC12-48V	2,800	140	>70	2200K-7000K	3 hours
EX-40W D2YZDA	40W		5,600				
EX-60W D2YZDA	60W		8,400				
EX80W D2YZDA	80W		11,200				
EX-100W DYZDA	100W		14,000				
EX-150W DYZDA	150W		21,000				
EX-200W DYZDA	200W		28,000				
EX-220W DYZDA	220W		30,800				

Dimensions:

D2 Series

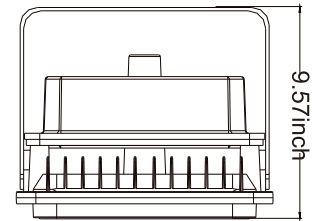
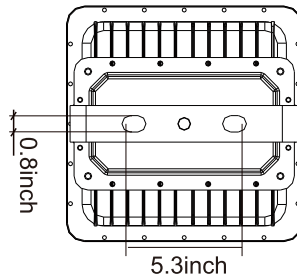
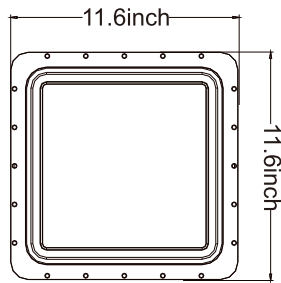

D Series

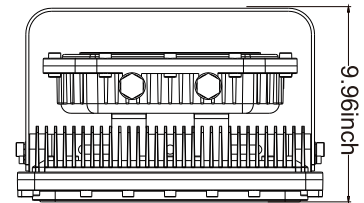
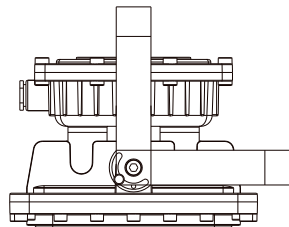
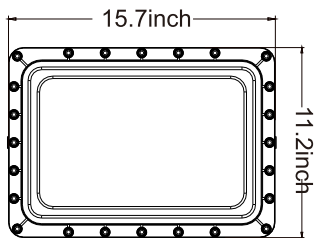

Mounting Methods:

◆ Ceiling Mounting:

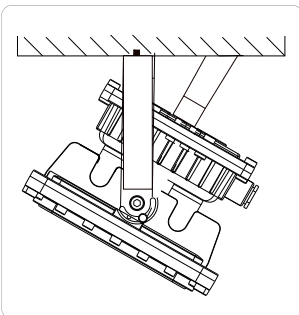

◆ Wall Mounting:

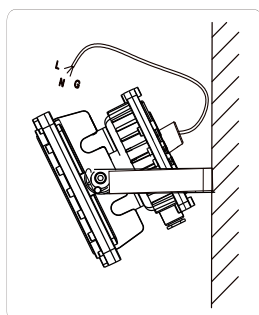

◆ Pole Mounting:

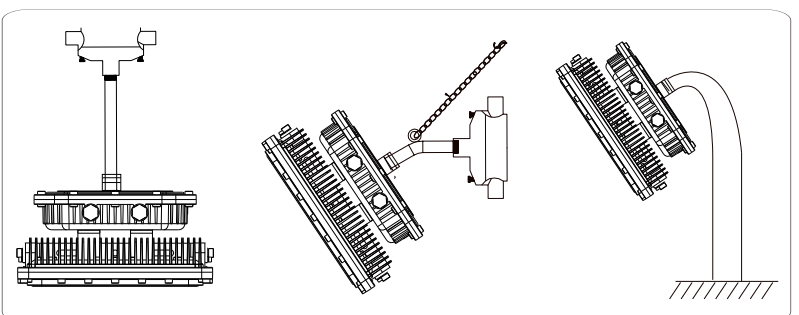

Accessories:



- **Model: Ex-Junction Box**
Material: Aircraft Aluminum A383



- **Model: EX-Straight Pipe**
Name: Straight Pipe
Material: Iron



- **Model: Ex-Conduit 01**
Name: Metal Conduit
Material: Stainless Steel and Aluminum



- **Model: EX-Bended Pipe**
Name: Bended Pipe
Material: Iron



- **Model: Ex-Chain**
Name: Pendant Chain
Material: Stainless Steel S30400



- **Model: Ex-Bracket**
Name: U-bracket
Material: Stainless Steel

Application :

- ◆ Oil and gas industry
 - All petroleum production and refining
 - Petroleum loading and transportation
 - Petroleum storage and retail
 - LNG industry
 - All mining operations and service
- ◆ Ocean, marine and aerospace field
 - Ocean platform operation facilities
 - Aerospace clean room and production
 - Ocean vessel operations
- ◆ Food and alcohol industry
 - Flour and fine particle production and storage
 - Food and distilling production
 - Alcohol industry
- ◆ Chemical industry
 - All types of paint facilities
 - Chemical production and storage
- ◆ Metal treatment
 - Steel and aluminum factories
 - Pumping stations in any environment
 - Metal smelting, foundry and fabrication
- ◆ Other high humidity, high dust, high temperature, vapor locations.