

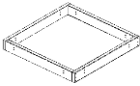









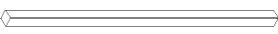









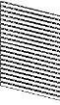



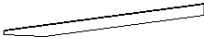
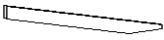
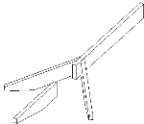

# KOTA GARDEN SAUNA

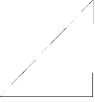
Instruction manual





1		Floor frame 980x980 (mm)	4 pcs
2		Wooden floor tile 895x895 (mm)	4 pcs
3		Pole 70x70x2100 (mm)	4 pcs
4		Wall frame with glass 910x2100 (mm)	2 pcs
5		Wall frame 910x2100 (mm)	2 pcs
6		Wall frame with small window 910x2100 (mm)	3 pcs
7		Door frame 910x2100 (mm)	1 pcs
8		Door	1 pcs
9		Wall element 852x2039 (mm)	2 pcs
10		Wall element 852x1400 (mm)	3 pcs
11		Plywood element 890x2085 (mm)	2 pcs
12		Plywood element 890x1485 (mm)	3 pcs
13		Plywood element 890x1125 (mm)	1 pcs



14		Plywood element (door) 890x250 (mm)	2 pcs
15		Door panel (upper) 852x150 (mm)	1 pcs
16		Roof board (corner) 91x1340 (mm)	4 pcs
17		Roof board (center) 91x947 (mm)	4 pcs
18		Corner board (chimney) 91x1340 (mm)	1 pcs
19		Roof nut 160x160 (mm)	1 pcs
20		Plywood triangle (roof) 1188x1250 (mm)	8 pcs
21		Eaves board 28x70x2391 (mm)	4 pcs
22		Center board (inside) 150x1824 (mm)	1 pcs
23		Roof element (inside) 950x1823 (mm)	1 pcs
24		Roof element (inside) 865x1823 (mm)	1 pcs
25		Sauna bench holder	2 pcs
26		Sauna bench frame (upper) 500x1824 (mm)	1 pcs
27		Sauna bench frame (lower) 450x1824 (mm)	1 pcs
28		Sauna bench (upper)	1 pcs



29		Sauna bench (lower)	1 pcs
30		Rail	1 pcs
31		Sauna bench (floor)	1 pcs
34		Screw 5x35 (mm)	16 pcs
35		Screw 4x55 (mm)	162 pcs
36		Screw 5x70 (mm)	98 pcs
37		Screw 5x90 (mm)	12 pcs
39		10 mm bolt + nut + washer	8 pcs

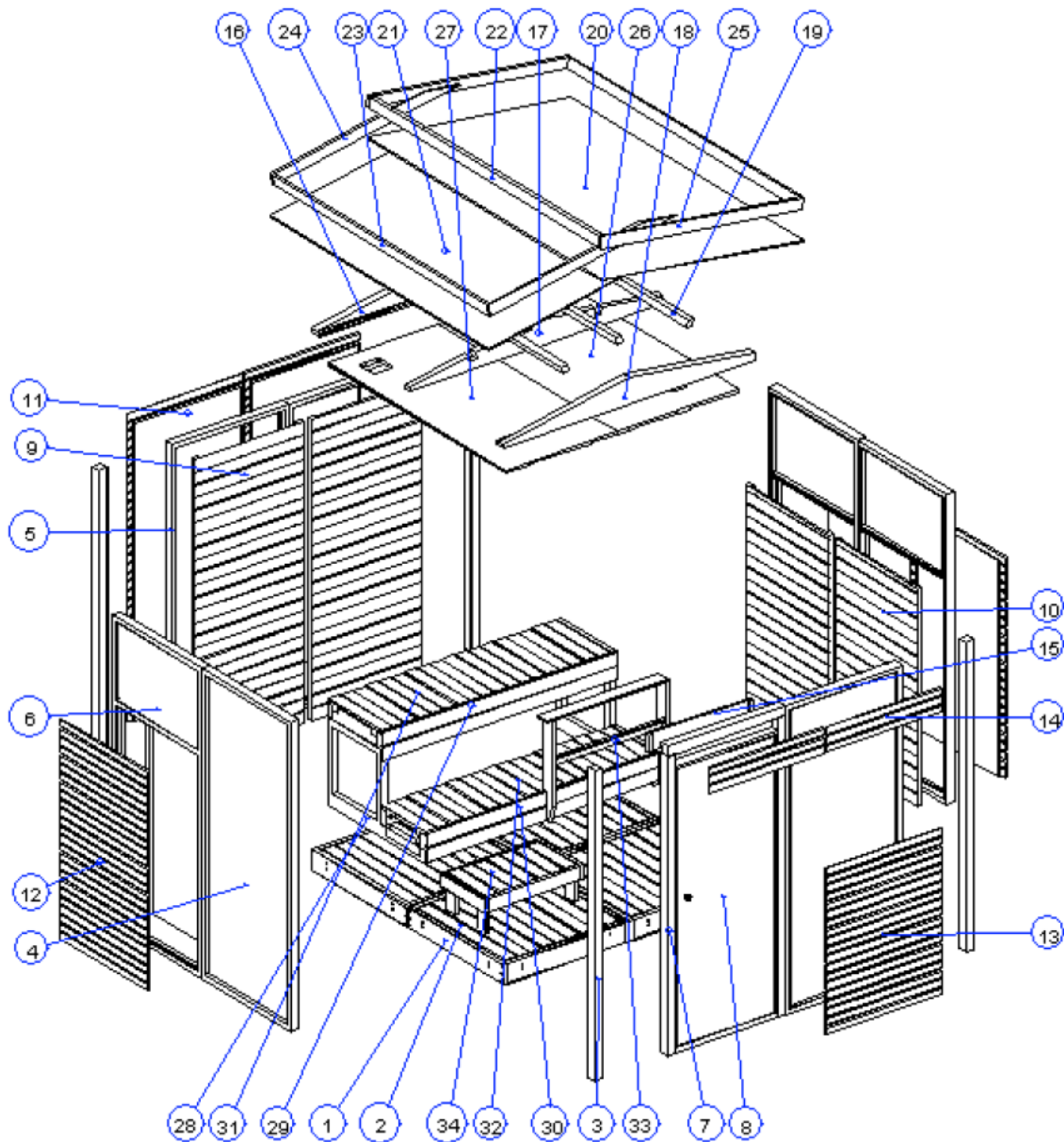

1. Put the floor frames (1) and floor tiles (2) together by using the bolts
2. Adjust the platform so it is in level.

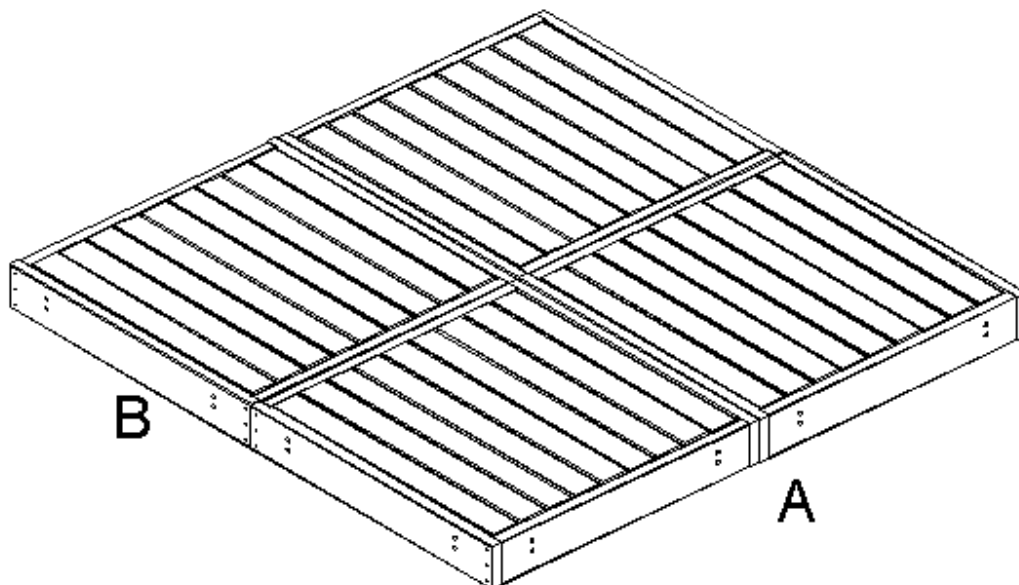

3. Install the wall frames (4-7) with four 5x70mm screws to other frames and with two 5x70mm screws to the floor. Start by fastening the wall elements to the pole (3).

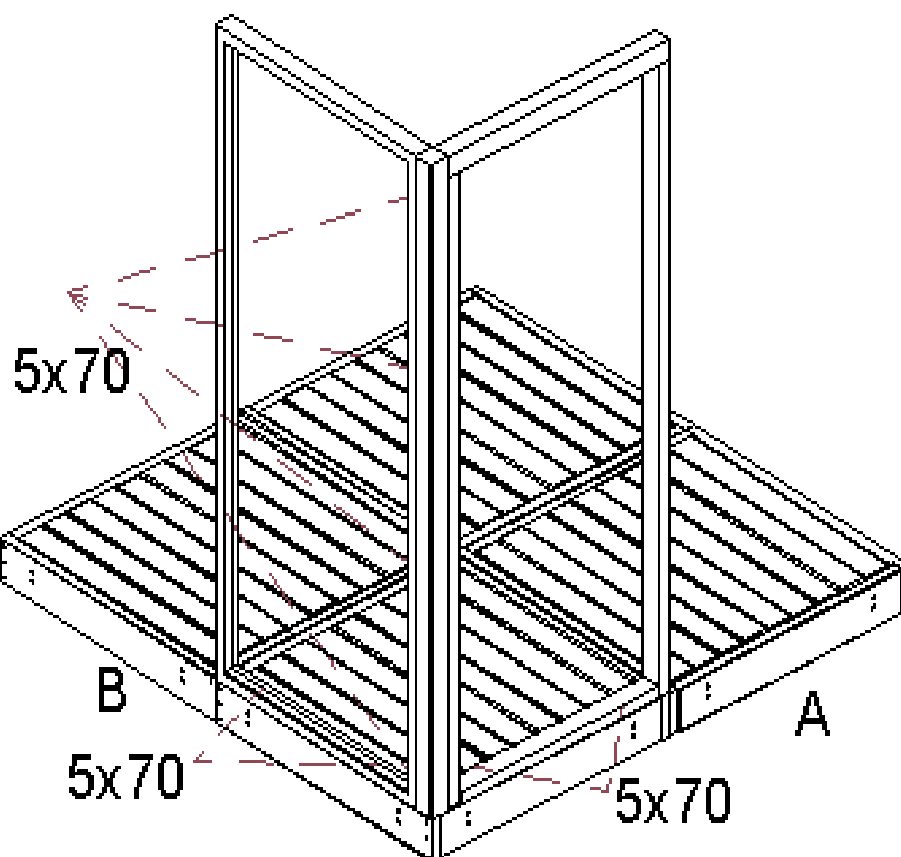

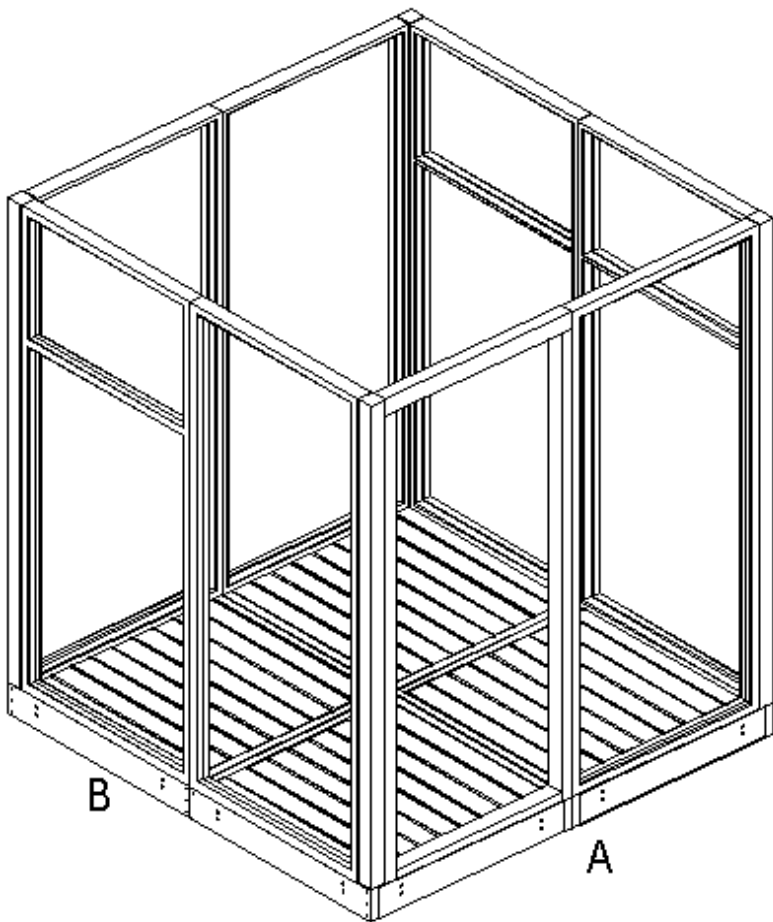

4. Install the wall elements with 4x55mm screws. The higher elements (9) with eight screws, and the lower elements (10) with six screws.

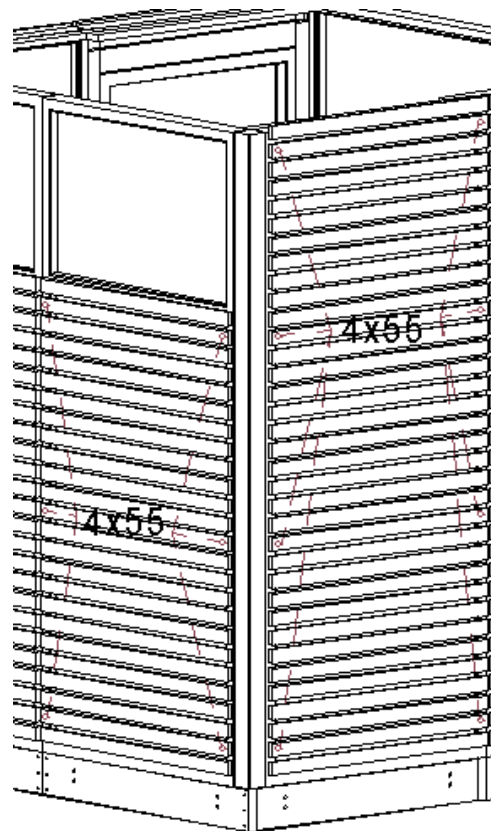
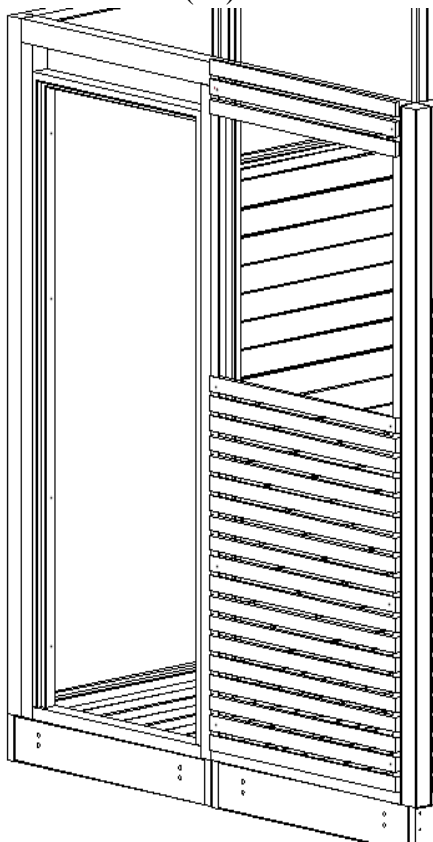

5. Install the door (8) with eight 5x70mm screws.

6. Put the plywood elements (11-14) on their places with 4x55mm screws. Higher ones with eight screws, lower ones with six screws, and the smallest ones (14) with 4 screws.





7. Fasten the roof boards (16-17) with two 5x70mm screws to (19) in middle, and with three screws on the sides.

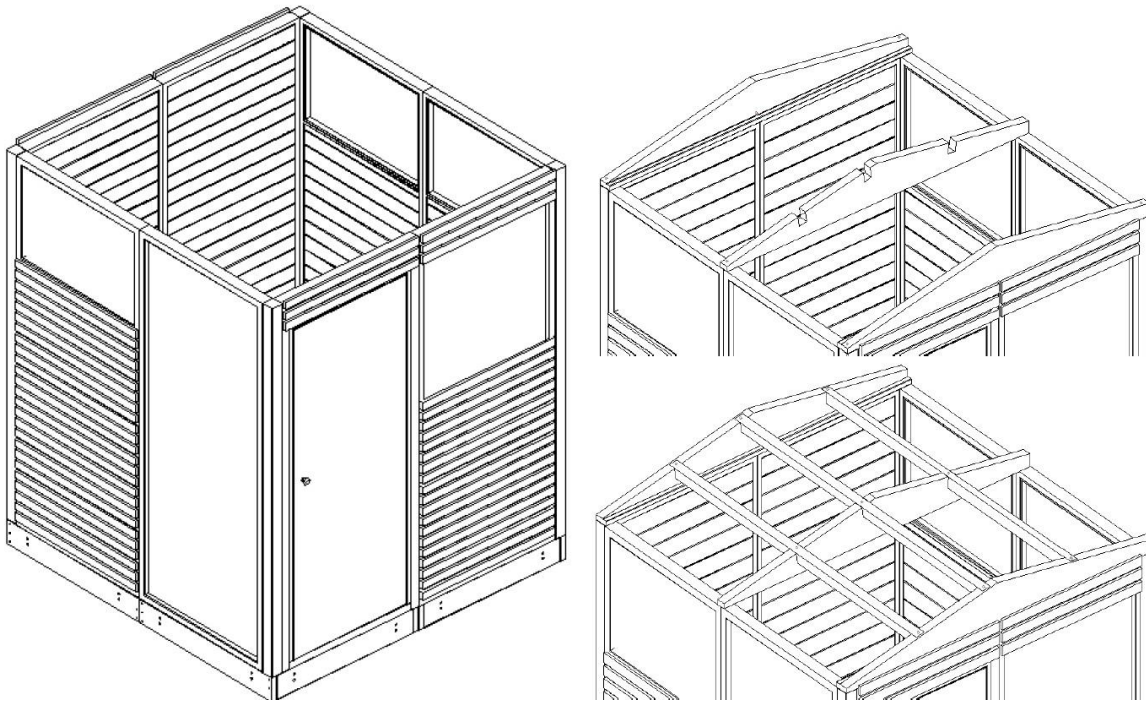

8. Place the 48x48 poles on the roof, with three 5x70mm screws.

9. Fasten the eaves boards (21) with six 4x55mm screws per plate.

10. Fasten the roof boards with 4x55 screws, longer with five, and shorter with three screws.

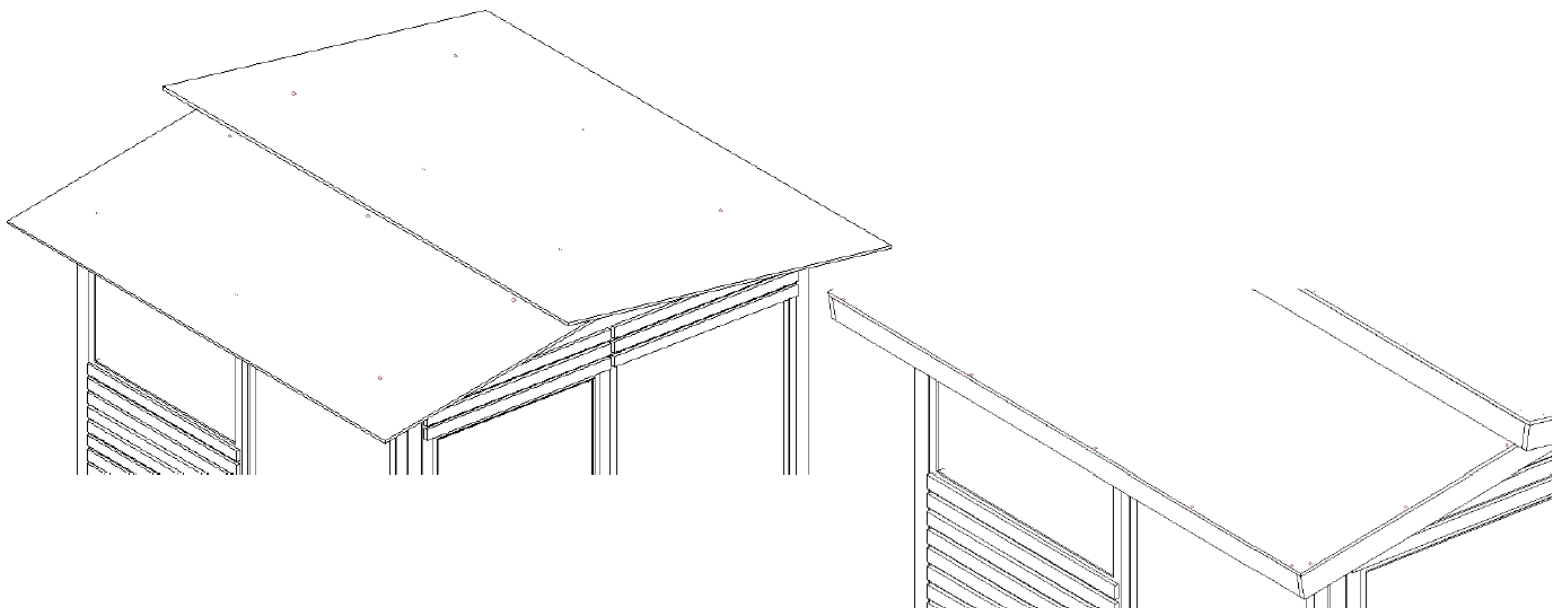



11. Install the roof elements at inside (22-24) with six 5x70mm screws, so that the ventilation hole is on the opposite side with the stove.

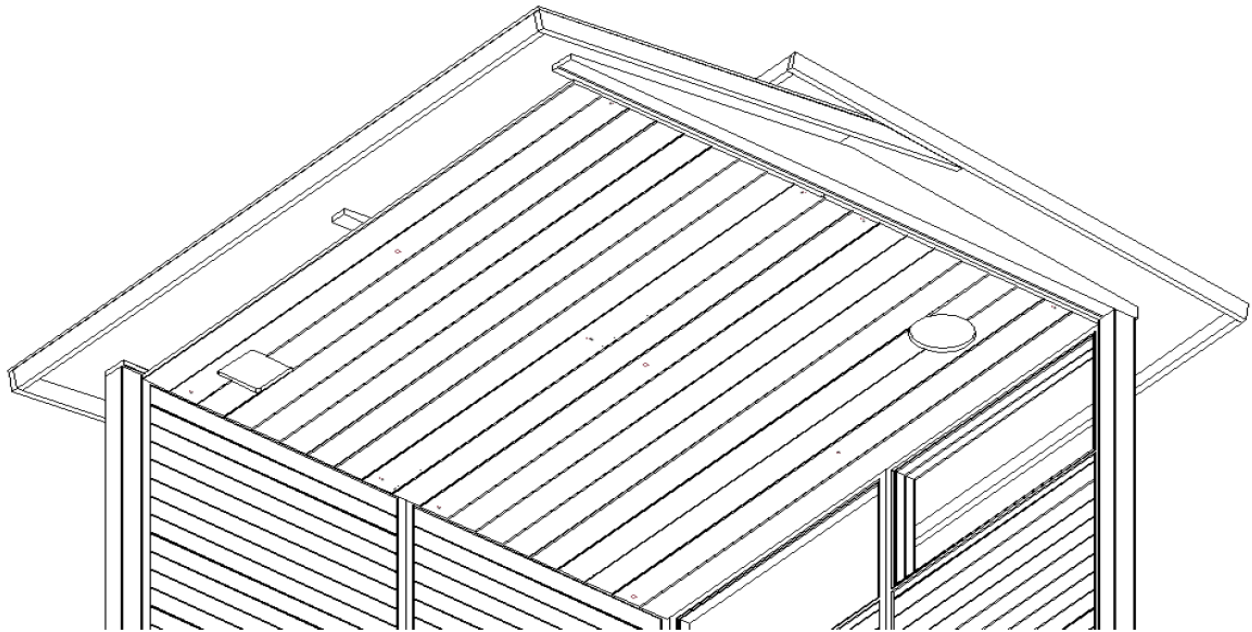

12. Fasten the sauna bench holders (25) with five 5x90mm screws.

13. Install the sauna bench frames (26-27) with eight 5x70mm screws (4 per side).

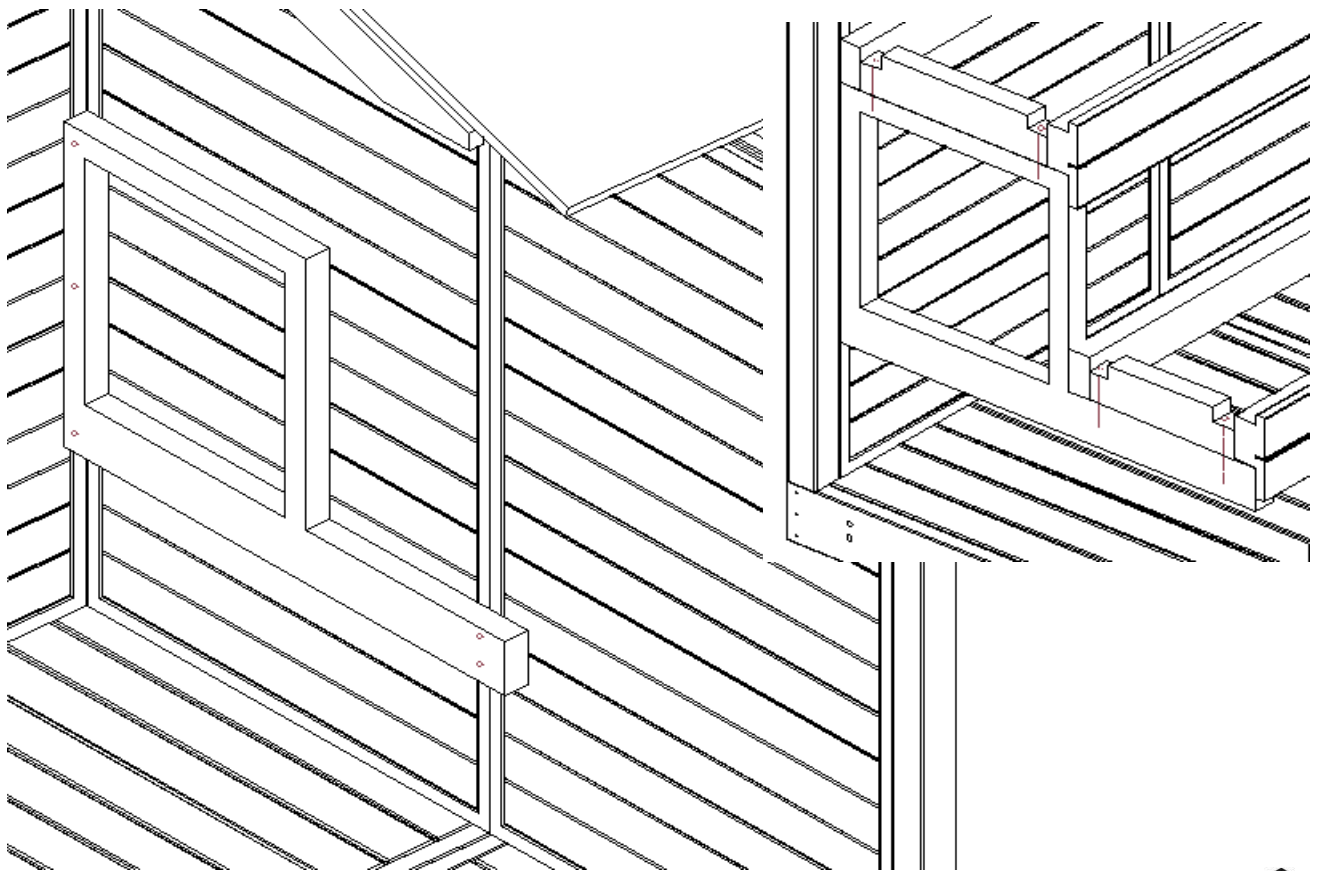

14. Install the rail (30) to the sauna bench frame with two 5x70mm screws at both ends. Fasten the screws from the frame to the rail.

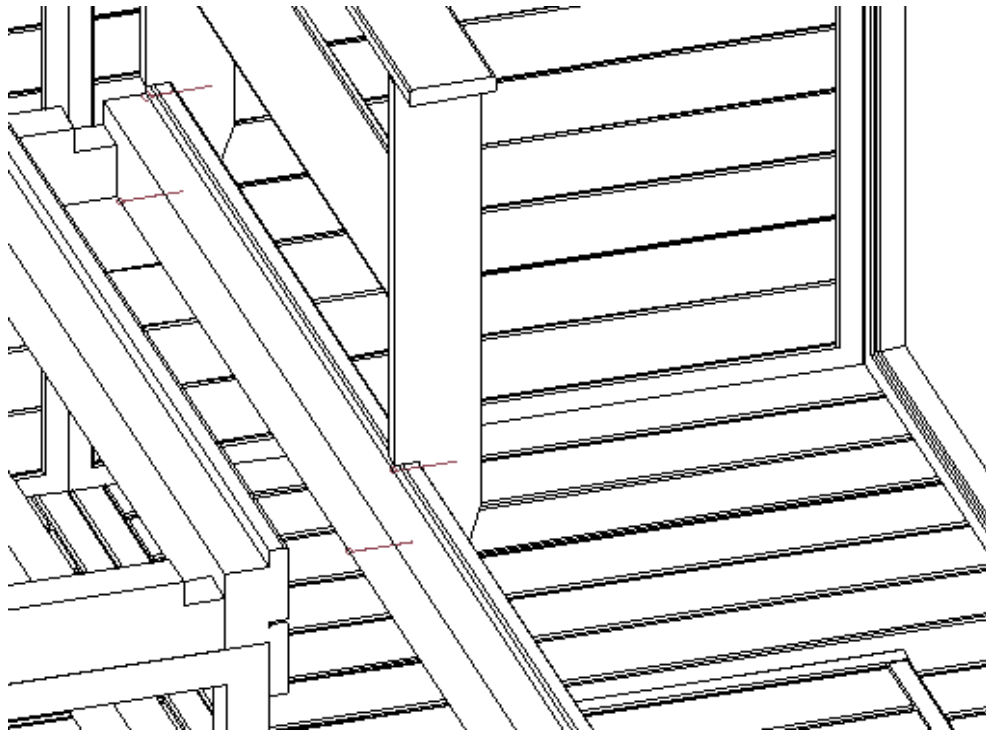

15. Put the sauna benches on their place.

