

Acrylic Podium

Instruction Manual



SKU: STAND-PDMA/-B



Scan the QR code with your mobile device or follow the link for helpful videos and specifications related to this product.

<https://vivo-us.com/products/stand-pdma>

GET IN TOUCH | Monday-Friday from 7:00am-7:00pm CST



help@vivo-us.com



www.vivo-us.com
Chat live with an agent!



309-278-5303

WARNING!

If you do not understand these directions, or if you have any doubts about the safety of the installation, please call a qualified technician. Check carefully to make sure there are no missing or defective parts. Improper installation may cause damage or serious injury. Do not use this product for any purpose that is not explicitly specified in this manual. Do not exceed weight capacity. We cannot be liable for damage or injury caused by improper mounting, incorrect assembly or inappropriate use.

WARNING: CHOKING HAZARD

SMALL PARTS - NOT FOR CHILDREN UNDER 3 YEARS. ADULT SUPERVISION IS REQUIRED.

PACKAGE CONTENTS

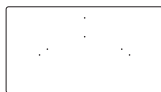

A (x1)
Base



B (x1)
Front Wall

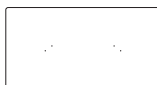

C (x1)
Top



D (x2)
Side Wall



E (x1)
Support



F (x1)
Rubber Pads



S-A (x18)
M3x16mm Screw



T-A (x1)
Phillips Screwdriver

NOTE: SOME HARDWARE INCLUDED MAY NOT BE USED

22lbs
(10kg)

DO NOT EXCEED WEIGHT CAPACITY.
Failure to do so may result in serious injury.

ASSEMBLY STEPS

STEP 1

Inspect Base (**A**) and locate the side with the smaller hole openings. This is the top. Orient Support (**E**) with the curved side with holes facing up and the flat side with holes facing down. Connect the Support (**E**) to the top of Base (**A**) in the middle hole set using M3x16mm Screws (**S-A**) and Phillips Screwdriver (**T-A**). Do not fully tighten screws.

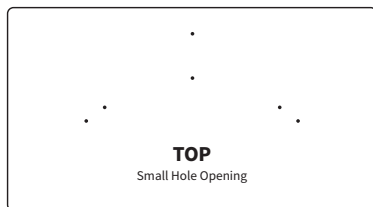

TOP
Small Hole Opening

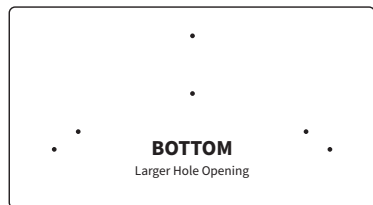

BOTTOM
Larger Hole Opening

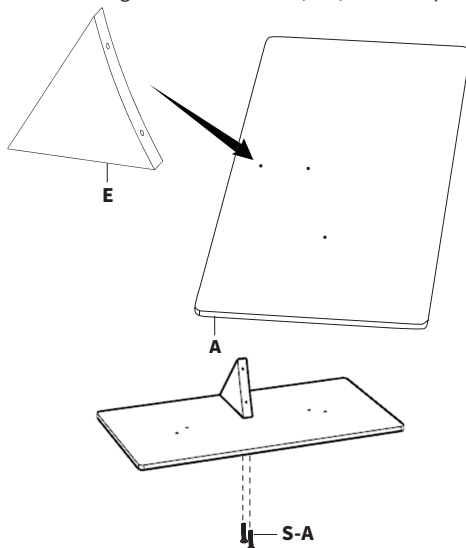

STEP 2

Remove Rubber Pads (**F**) from adhesive backing and apply to bottom side of Base (**A**). This is opposite the side that Support (**E**) was installed on.

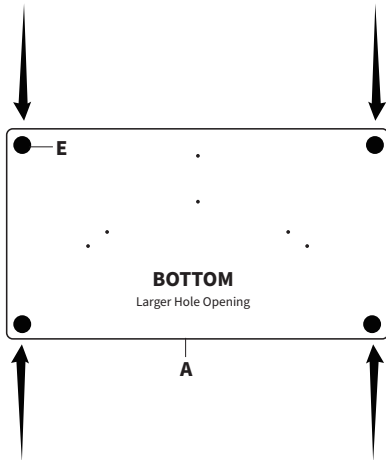

STEP 3

Connect Side Walls (**D**) to Front Wall (**B**) using M3x16mm Screws (**S-A**) and Phillips Screwdriver (**T-A**). Do not fully tighten screws.

NOTE: Make sure the flat side of Side Walls (**D**) are on bottom, and the slanted sides are on top.

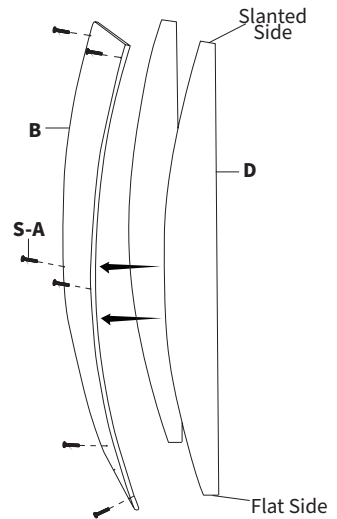

STEP 4

Connect main structure assembly to Base (**A**) using M3x16mm Screws (**S-A**) and Phillips Screwdriver (**T-A**). Do not fully tighten screws.

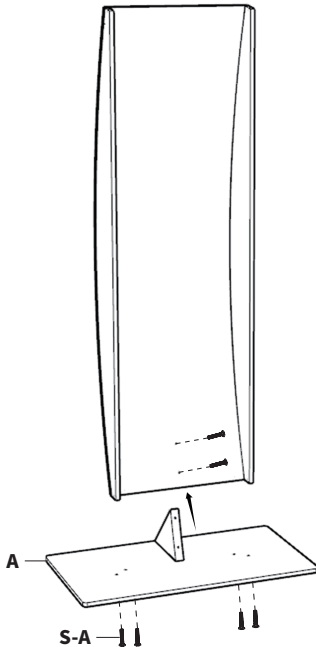

STEP 5

Assemble Top (**C**) to assembly using M3x16mm Screws (**S-A**) and Phillips Screwdriver (**T-A**). Fully tighten all of the previously installed screws.

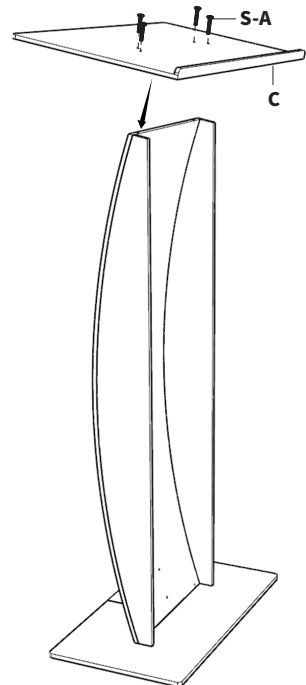



Love your new VIVO setup and want to share?
Tag us in your photo! **@vivo_us**

LAST UPDATED: 11/20/2023
REV1



Open **Monday - Friday 7:00am - 7:00pm** CST,
our dedicated support team can offer immediate assistance with rapid response times. If any parts are received damaged or defective, please contact us. We are happy to replace parts to ensure you have a fully functioning product.



309-278-5303

AVG. RESOLUTION TIME (*within office hrs*): **5M 4S**



www.vivo-us.com
Chat live with an agent!

AVG. RESOLUTION TIME (*within office hrs*): **< 15 M**



help@vivo-us.com

AVG. RESPONSE TIME (*within office hrs*): **1HR 8M**

- 23% within < 15m
- 38% within < 30m
- 61% within < 1hr
- 83% within < 2hr
- 92% within < 3hr

FOR MORE VIVO PRODUCTS, CHECK OUT OUR WEBSITE AT: www.vivo-us.com