

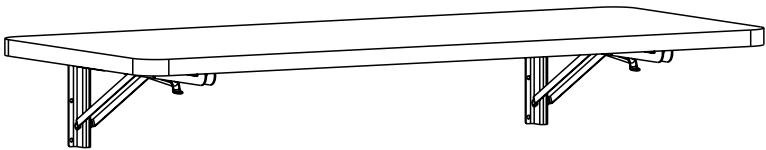

Black Wall Mounted 43” Folding Workbench

Instruction Manual



SKU: MOUNT-SF1FB



Scan the QR code with your mobile device or follow the link for helpful videos and specifications related to this product.

<https://vivo-us.com/products/mount-sf1fb>

GET IN TOUCH | Monday-Friday from 7:00am-7:00pm CST



help@vivo-us.com



www.vivo-us.com
Chat live with an agent!



309-278-5303

WARNING!

If you do not understand these directions, or if you have any doubts about the safety of the installation, please call a qualified technician. Check carefully to make sure there are no missing or defective parts. Improper installation may cause damage or serious injury. Do not use this product for any purpose that is not explicitly specified in this manual. Do not exceed weight capacity. We cannot be liable for damage or injury caused by improper mounting, incorrect assembly or inappropriate use.

PACKAGE CONTENTS

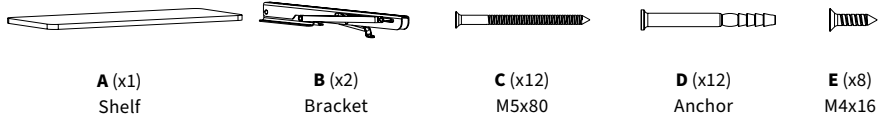

NOTE: NOT ALL HARDWARE INCLUDED WILL BE USED

CAUTION!

DO NOT INSTALL INTO DRYWALL ALONE. VERIFY YOUR WALL CONSTRUCTION. USE WOOD STUDS TO MOUNT. We include mounting hardware for brick and concrete walls. If unsure, please contact us at vivo-us.com, email at help@vivo-us.com, or call us at 309-278-5303.

TOOLS NEEDED

DO NOT EXCEED WEIGHT CAPACITY.
Failure to do so may result in serious injury.



WARNING: CHOKING HAZARD
SMALL PARTS - NOT FOR CHILDREN UNDER 3 YEARS. ADULT SUPERVISION IS REQUIRED.

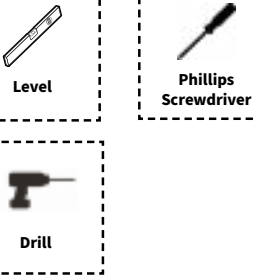

ASSEMBLY STEPS

STEP 1

Unfold the brackets (B) to the open position.

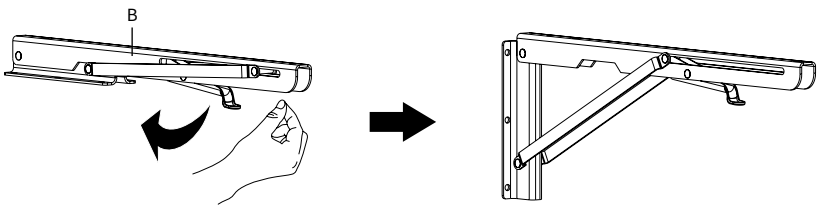

STEP 2

OPTION A: Wood Stud Wall

Place brackets against the wall, aligning only 3 vertical holes on each bracket with center of stud (other 3 holes will be unused), and mark drilling locations. Use of a level and stud finder is recommended. Drill 3" deep holes using a 1/8" drill bit, and secure brackets to wall using M5x80 screws (C).



OPTION B: Brick/Concrete Wall

Place brackets against the wall and mark drilling locations. Use of a level is recommended. Drill 3" deep holes using a 5/16" drill bit and press anchors (D) into holes. Secure brackets to wall using M5x80 screws (C).

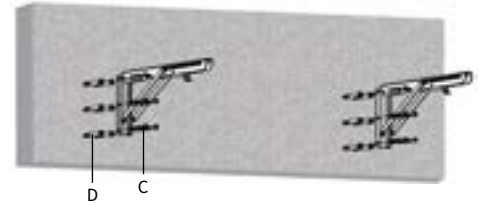

NOTE: The anchors are meant only for use with brick or concrete walls and should not be used with wood or drywall.

STEP 3

Place the shelf (A) on the mounted brackets, making sure the back of the shelf is spaced at least 3/8" (10mm) from the wall. Secure the brackets to the shelf using M4x16 screws (E) (If needed, pilot holes may be drilled using a 3/32" drill bit).

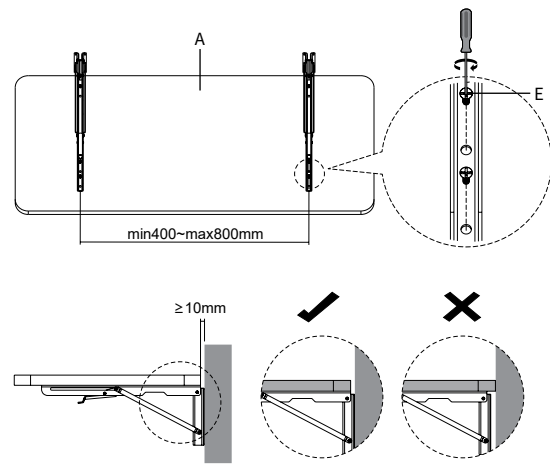

STEP 4

Squeeze the levers to fold the shelf against the wall when not in use. To raise the shelf, simply pull up until the latches engage.

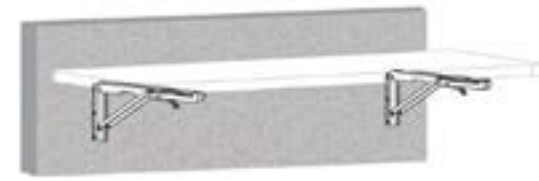



Love your new VIVO setup and want to share?
Tag us in your photo! **@vivo_us**

LAST UPDATED: 09/11/2020



Open **Monday - Friday 7:00am - 7:00pm** CST,
our dedicated support team can offer immediate assistance with rapid response times. If any parts are received damaged or defective, please contact us. We are happy to replace parts to ensure you have a fully functioning product.



help@vivo-us.com

AVG. RESPONSE TIME (*within office hrs*): **1HR 8M**

- 23% within < 15m
- 38% within < 30m
- 61% within < 1hr
- 83% within < 2hr
- 92% within < 3hr



www.vivo-us.com
Chat live with an agent!

AVG. RESOLUTION TIME (*within office hrs*): **< 15 M**



309-278-5303

AVG. RESOLUTION TIME (*within office hrs*): **5M 4S**

FOR MORE VIVO PRODUCTS, CHECK OUT OUR WEBSITE AT: www.vivo-us.com