

32" x 24.4" Electric Desk Riser

Instruction Manual

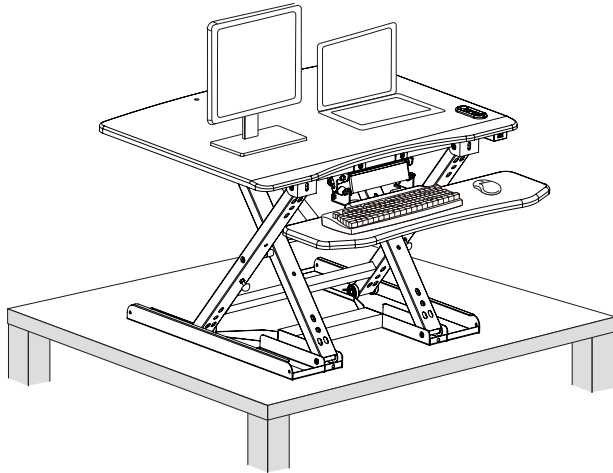

SKU: DESK-V000EE



Scan the QR code with your mobile device or follow the link for helpful videos and specifications related to this product.

<https://vivo-us.com/products/desk-v000ee>



help@vivo-us.com



www.vivo-us.com



1-800-371-5654

⚠ WARNING!

If you do not understand these directions, or if you have any doubts about the safety of the installation, please call a qualified technician. Check carefully to make sure there are no missing or defective parts. Improper installation may cause damage or serious injury. Do not use this product for any purpose that is not explicitly specified in this manual and do not exceed weight capacity. We cannot be liable for damage or injury caused by improper mounting, incorrect assembly, or inappropriate use.

⚠ ELECTRICAL SAFETY INSTRUCTIONS

THIS PRODUCT IS POWERED BY ELECTRICITY. IN ORDER TO AVOID BURNS, FIRE AND ELECTRIC SHOCK. PLEASE READ THE FOLLOWING INSTRUCTIONS CAREFULLY.

- DO NOT CLEAN PRODUCT WHILE POWER IS CONNECTED.
- DO NOT DISASSEMBLE OR REPLACE COMPONENTS WHILE POWER IS CONNECTED.
- NEVER OPERATE THE SYSTEM WITH A DAMAGED CORD OR PLUG. PLEASE CONTACT YOUR SELLER TO REPLACE DAMAGED PARTS.
- NEVER OPERATE SYSTEM IN DAMP ENVIRONMENTS OR IF ANY ELECTRICAL COMPONENTS HAVE MADE CONTACT WITH LIQUIDS.
- ALTERATIONS OF THE GIVEN POWER UNIT ARE NOT ALLOWED.
- OUTDOOR USE IS PROHIBITED.

PACKAGE CONTENTS

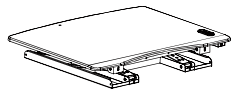

A (x1)
Adjustable
Desktop

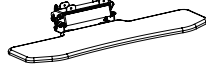

B (x1)
Keyboard
Tray

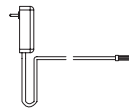

C (x1)
Power
Adapter



D (x2)
Screw

TOOLS NEEDED



Phillips
Screwdriver



Scissors

**⚠ WARNING
PINCH POINT**

DO NOT place hands on or near support bars. Moving parts can crush and cut. Pinch points are created during lifting and lowering the worksurface. Failure to follow these instructions may result in serious personal injury.



DO NOT EXCEED WEIGHT CAPACITY.
Failure to do so may result in serious injury.



ASSEMBLY STEPS

STEP 1

Carefully remove the desktop and contents from packaging. Cut ties from Desktop (A). Plug the power adapter (C) into the desk and an electrical outlet.

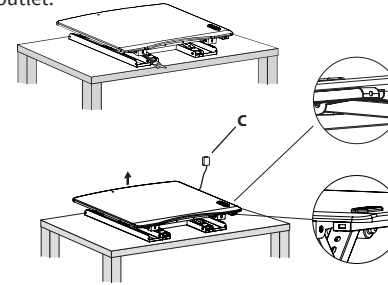

STEP 2

Press the "Up" button to raise the desktop.

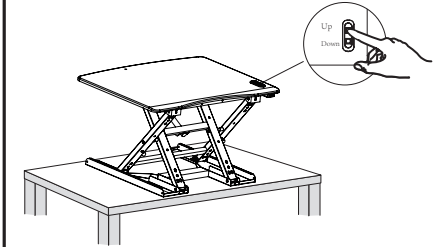

STEP 3

Insert the keyboard tray (B) into the support bracket underneath. Align the mounting holes, then secure the keyboard tray using the two screws (D).

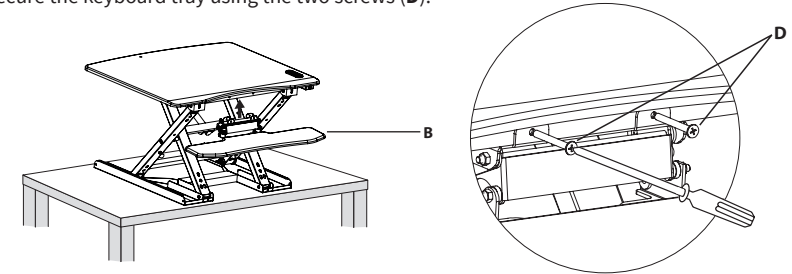

⚠ CAUTION!



Keep monitor and laptop base fully on the desktop.

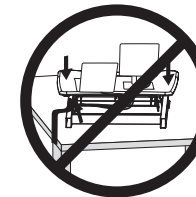

Follow the cable routing instructions to avoid the potential to pinch cables.



Leave enough slack in cable to allow for full range of vertical motion (15" / 38 cm).



Raise desktop slowly to keep items stable.

Failure to follow these instructions may result in property damage and/or personal injury.



Love your new VIVO setup and want to share?

Tag us in your photo! **@vivo_us**

Last Updated: 11/20/2018



If any parts are received damaged or defective, please contact us. We are happy to replace parts to ensure you have a fully functioning product.



help@vivo-us.com



www.vivo-us.com



1-800-371-5654

For more VIVO products, check out our website at:
www.vivo-us.com.