

83" x 83" Curved Corner Table Top

SKU: *DESK-TOP83CB*
Instruction Manual

Assembly Video & Product Info
www.vivo-us.com/products/desk-top2cb



! CAUTION! !

If you do not understand these directions, or if you have any doubts about the safety of the installation, please contact our product support team at 309-278-5303 or help@vivo-us.com for further assistance. Check carefully to make sure there are no missing or defective parts. Improper installation may cause damage or serious injury. Do not use this product for any purpose that is not explicitly specified in this manual. Do not exceed weight capacity. We cannot be liable for damage or injury caused by improper mounting, incorrect assembly or inappropriate use.



WARNING: CHOKING HAZARD

SMALL PARTS - NOT FOR CHILDREN UNDER 3 YEARS. ADULT SUPERVISION IS REQUIRED.



DO NOT EXCEED WEIGHT CAPACITY

FAILURE TO DO SO MAY RESULT IN SERIOUS INJURY.

We're Here for You

Open **Monday - Friday 7:00am - 7:00pm** CST, our dedicated support team can offer immediate assistance with rapid response times. If any parts are received damaged or defective, please contact us. We are happy to replace parts to ensure you have a fully functioning product.



Give us a Call:
309-278-5303

AVG. RESOLUTION TIME (*within office hrs*): **5M 4S**



Chat Us:
www.vivo-us.com

AVG. RESOLUTION TIME (*within office hrs*): **< 15 M**



Email Us:
help@vivo-us.com

AVG. RESPONSE TIME (*within office hrs*): **1HR 8M**

- 23% within < 15m
- 38% within < 30m
- 61% within < 1hr
- 83% within < 2hr
- 92% within < 3hr

Package Contents

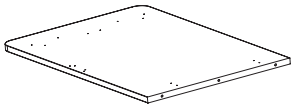

A (x1)
Left Panel

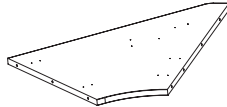

B (x1)
Left Middle
Panel

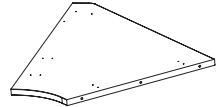

C (x1)
Right Middle
Panel

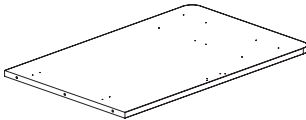

D (x1)
Right Panel

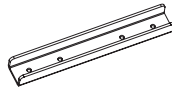

E (x6)
Support Bar

Included Hardware & Tools



S-A (x10)
Wooden Dowel Pin



S-B (x24)
ST4.2x20mm Screw

Tools Needed:



**Phillips
Screwdriver**

ASSEMBLY STEPS

STEP 1

Place Desktop Panels (A, B, C, D) upside down on a protective surface and insert Wooden Dowel Pins (S-A) into Right Middle Panel (C) and connect Right Panel (D).

Connect Left Panel (A) and Left Middle Panel (B) to Right Middle Panel (C) and Right Panel (D) using Wooden Dowel Pins (F).

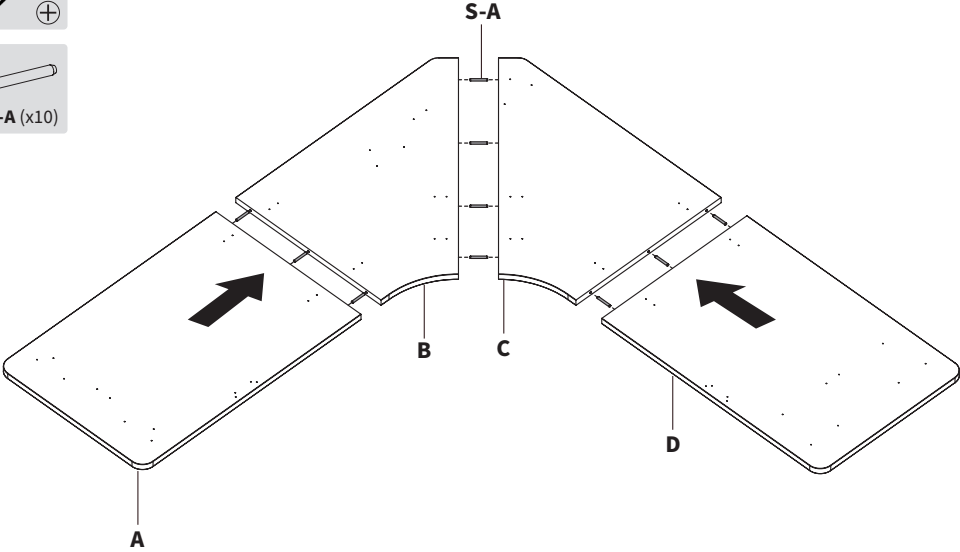

STEP 2

Attach Support Bars (**E**) to desktop assembly using ST4.2x20mm Screws (**S-B**) and a Phillips screwdriver.

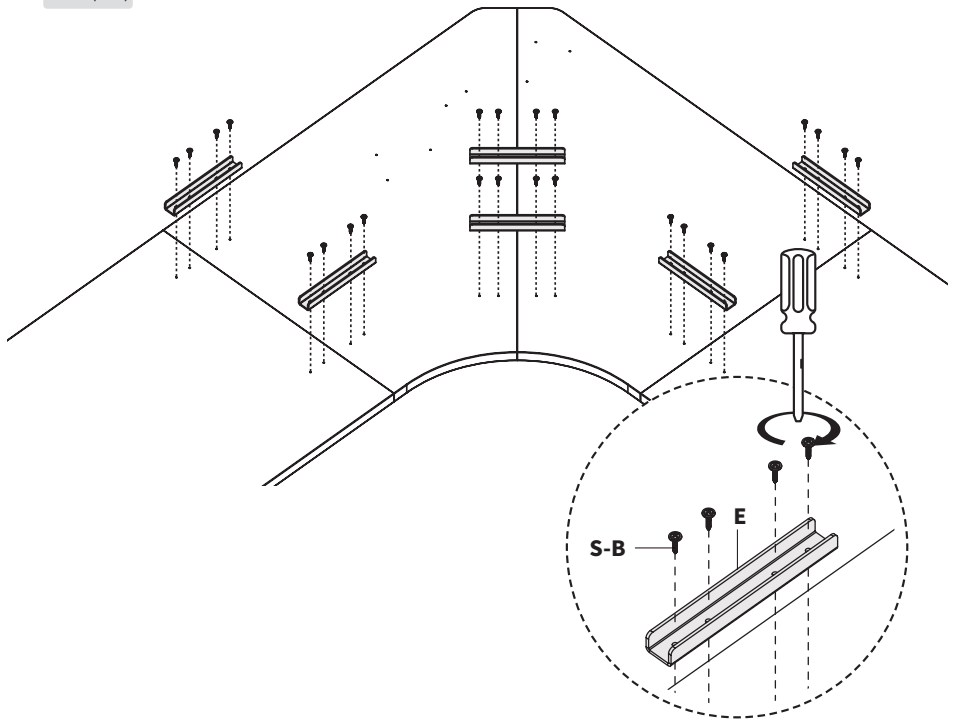

STEP 3

Place your desk frame (not included) upside down on the desktop assembly. Adjust frame width to match desktop mounting holes, and secure frame to desktop assembly using hardware provided in your desk frame kit.

Mount the control panel to mounting holes on left or right side of the desktop assembly using screws included with the desk frame. For VIVO frames, pre-drilled holes have been included for most control panels.

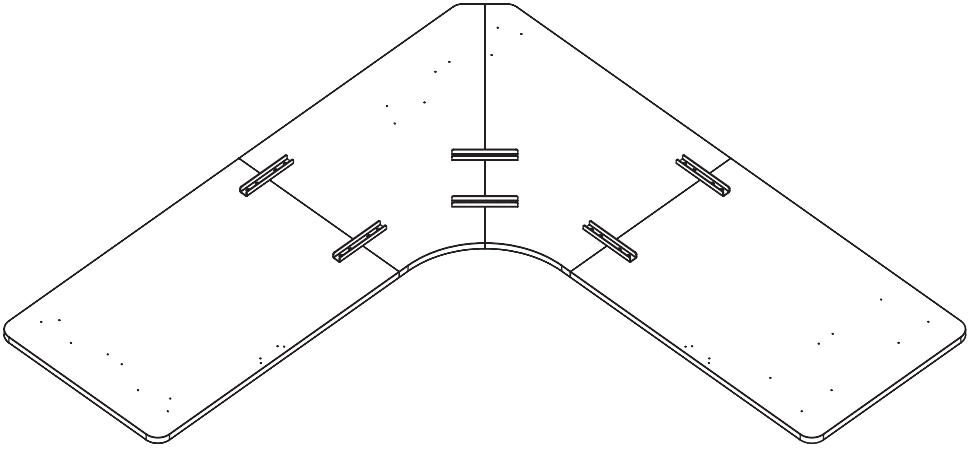

[THIS PAGE INTENTIONALLY LEFT BLANK]



Need Help? Get In Touch

Monday-Friday from 7:00am-7:00pm CST



help@vivo-us.com



www.vivo-us.com

Chat live with an agent!



309-278-5303



VIVO-us @vivo_us