

63" x 32" Table Top with Built-in Power Strip

Instruction Manual

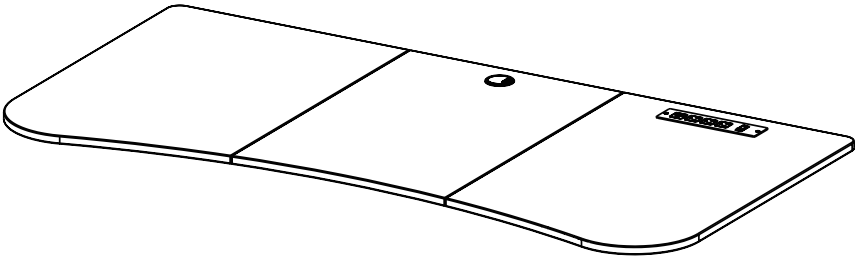

SKU: DESK-TOP1AC-B



Scan the QR code with your mobile device or follow the link for helpful videos and specifications related to this product.

<https://vivo-us.com/products/desk-top1ac-b>

GET IN TOUCH | Monday-Friday from 7:00am-7:00pm CST



help@vivo-us.com



www.vivo-us.com

Chat live with an agent!



309-278-5303

⚠️ WARNING!

If you do not understand these directions, or if you have any doubts about the safety of the installation, please call a qualified technician. Check carefully to make sure there are no missing or defective parts. Improper installation may cause damage or serious injury. Do not use this product for any purpose that is not explicitly specified in this manual and do not exceed weight capacity. We cannot be liable for damage or injury caused by improper mounting, incorrect assembly, or inappropriate use.

⚠️ WARNING: CHOKING HAZARD

SMALL PARTS - NOT FOR CHILDREN UNDER 3 YEARS. ADULT SUPERVISION IS REQUIRED.

PACKAGE CONTENTS

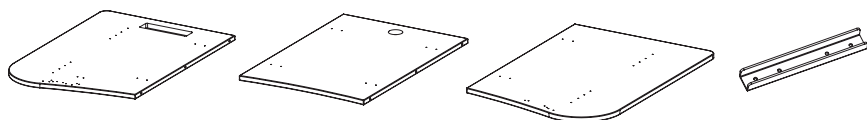

A (x1) Right Panel **B** (x1) Middle Panel **C** (x1) Left Panel **D** (x4) Support Bar

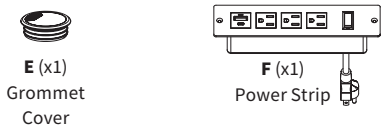

E (x1) Grommet Cover **F** (x1) Power Strip



S-A (x30) ST4.2x16mm Screw **S-B** (x2) ST3.5x13mm Screw **S-C** (x6) Wooden Dowel Pin

TOOLS NEEDED



Phillips Screwdriver

ASSEMBLY STEPS

STEP 1

Place Desktop Panels (**A, B, C**) upside down on a protective surface and insert Wooden Dowel Pins (**S-C**) into Middle Panel (**B**). Connect Right Panel (**A**) and Left Panel (**C**) to Middle Panel (**B**) using Wooden Dowel Pins (**S-C**).

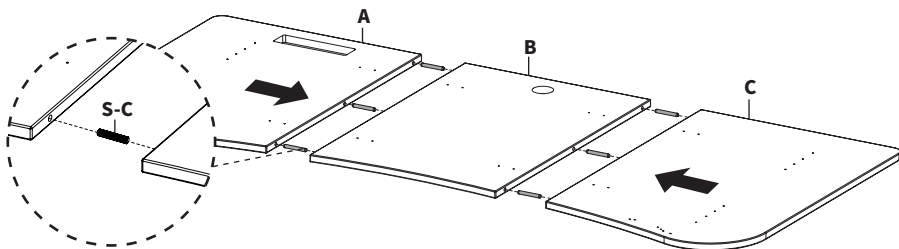

STEP 2

Attach Support Bars (**D**) to predrilled holes in desktop assembly using ST4.2x16mm Screws (**S-A**) and a Phillips screwdriver.

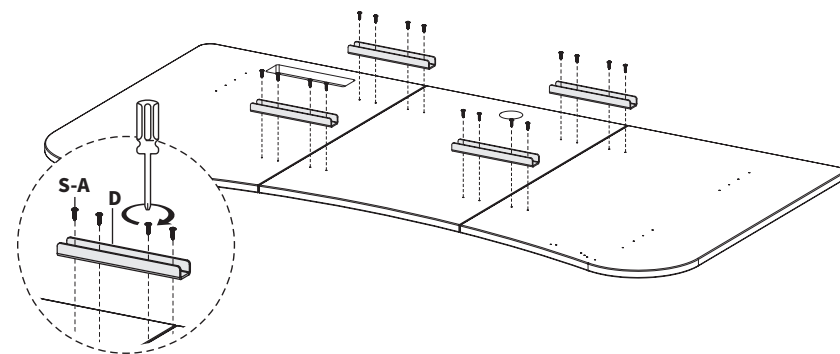

STEP 3

Install Power Strip (**F**) into desktop using ST3.5x13mm Screws (**S-B**) and a Phillips screwdriver. Place Grommet Cover (**E**) into grommet hole. Cover can be used for cable management.

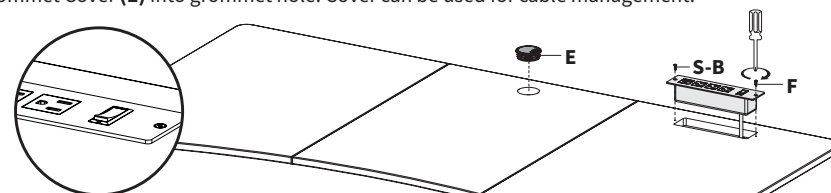

Note: Turn on Overload Protection Switch. It will flip if power exceeds 1500W. Do not frequently flip the switch manually.

STEP 4

Place desk frame upside down on the desktop assembly. Adjust frame width to match desktop mounting holes, and secure frame to desktop assembly using ST4.2x16mm Screws (**S-A**). For VIVO frames, pre-drilled holes have been included for most control panels and crank handles.

NOTE: Holes for some control panels and cranks are not pre-drilled. In this case, you must drill your own.

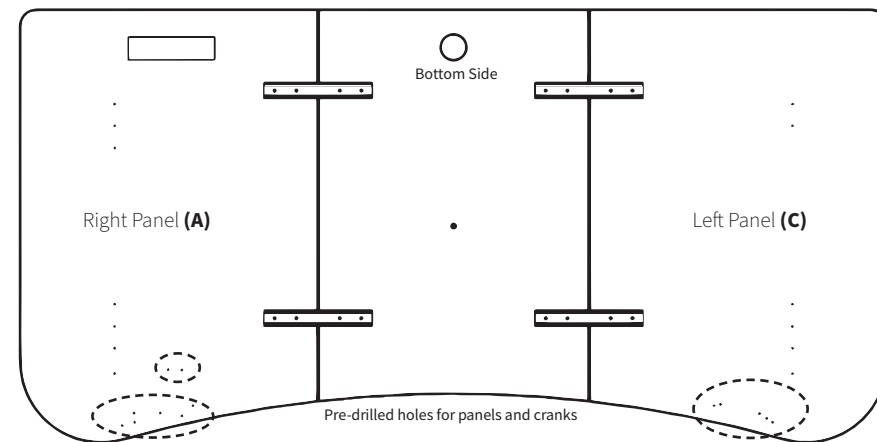



Open **Monday - Friday 7:00am - 7:00pm** CST,
our dedicated support team can offer immediate assistance with rapid response times. If any parts are received damaged or defective, please contact us. We are happy to replace parts to ensure you have a fully functioning product.



309-278-5303

AVG. RESOLUTION TIME (*within office hrs*): **5M 4S**



www.vivo-us.com
Chat live with an agent!

AVG. RESOLUTION TIME (*within office hrs*): **< 15 M**



help@vivo-us.com

AVG. RESPONSE TIME (*within office hrs*): **1HR 8M**

- 23% within < 15m
- 38% within < 30m
- 61% within < 1hr
- 83% within < 2hr
- 92% within < 3hr