











**Coops & Feathers™**  
Easy-to-Build, Backyard Chicken Coops



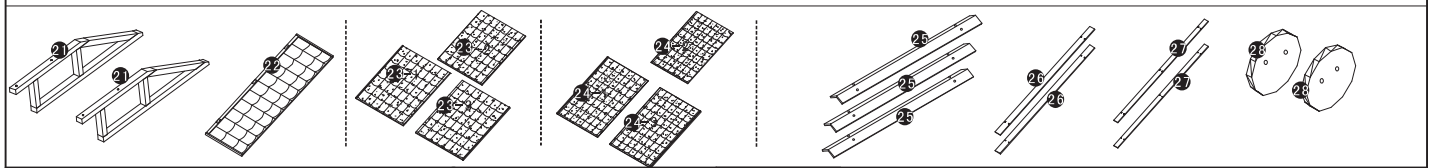
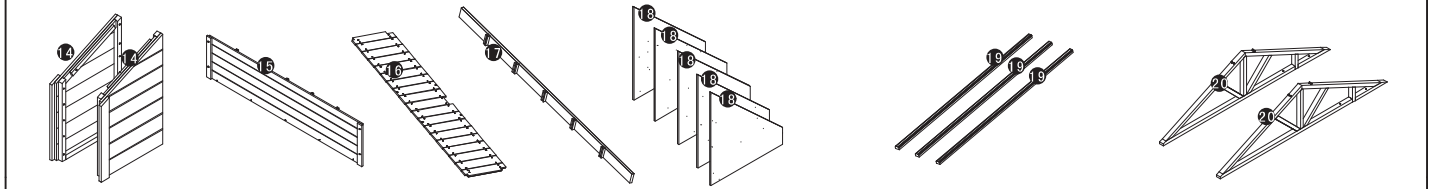
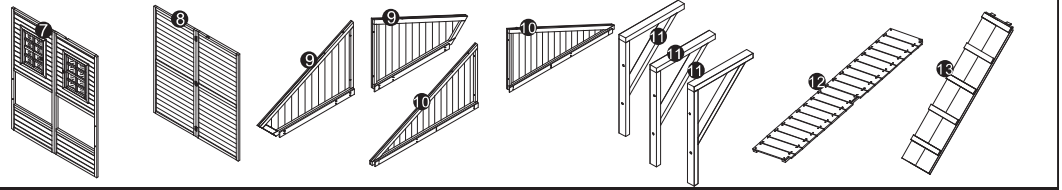
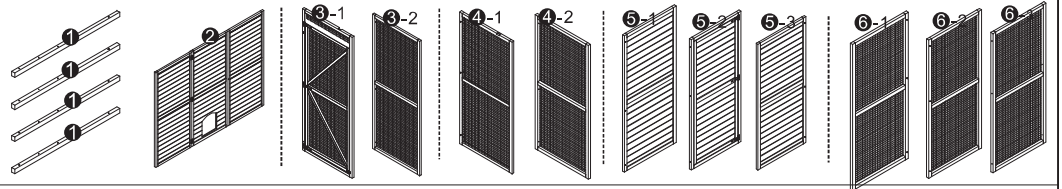

- A  VIS 3.5\*60=40
- B  VIS 3.5\*50=16
- C  VIS 3.5\*35=36
- D  VIS 3.5\*25=52
- E  VIS 3.0\*16=20
- F  VIS M6\*75=8
- G  VIS M6\*60=4
- H  VIS M6\*50=4
- I  =2



**STEP 1**

A  =16







**STEP 2**

A  =12  
 B  =12  
 E  =6  
 I  =1

**STEP 3**

A  =6

**STEP 4**

A  =6  
 B  =6  
 D  =6  
 E  =6  
 F  =2  
 I  =1



STEP 5

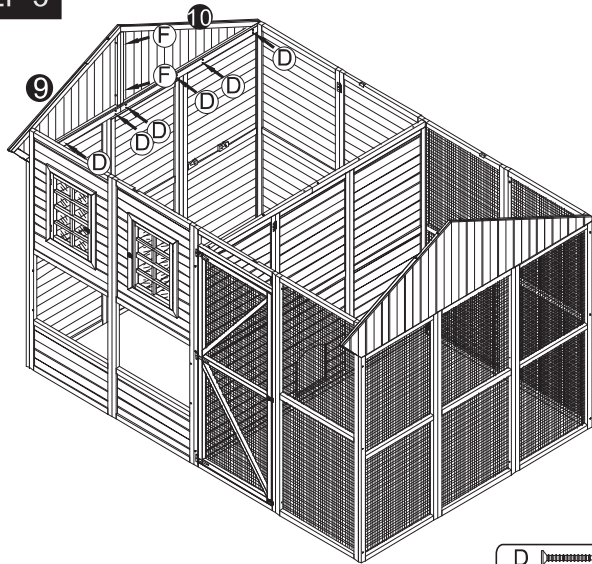

D = 6  
 F = 2

STEP 6

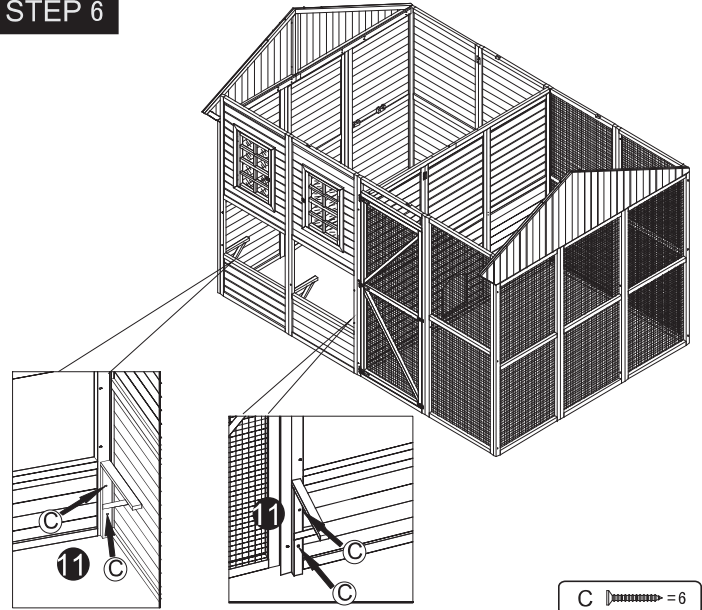

C = 6

STEP 7

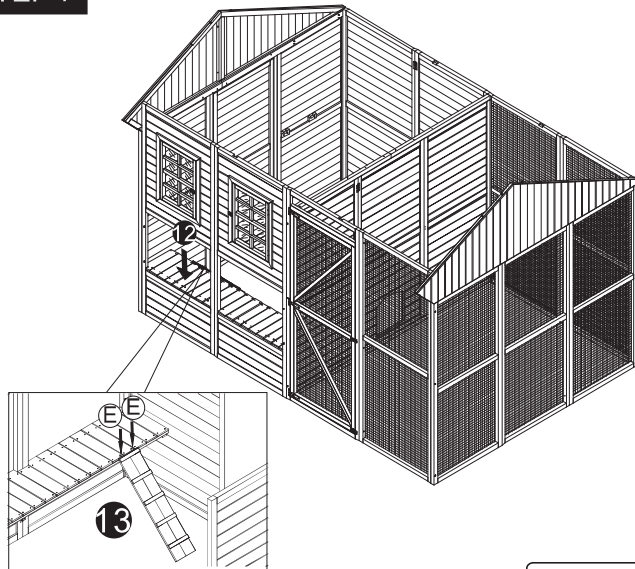

E = 2

STEP 8

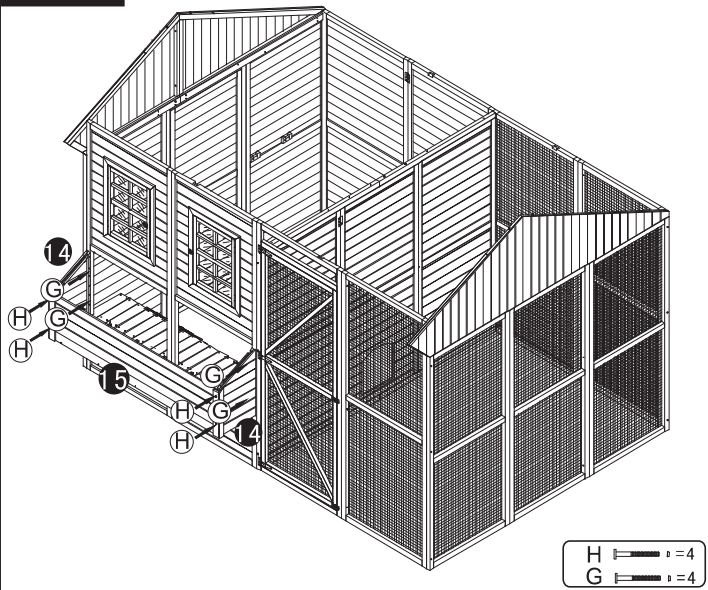

H = 4  
 G = 4

STEP 9

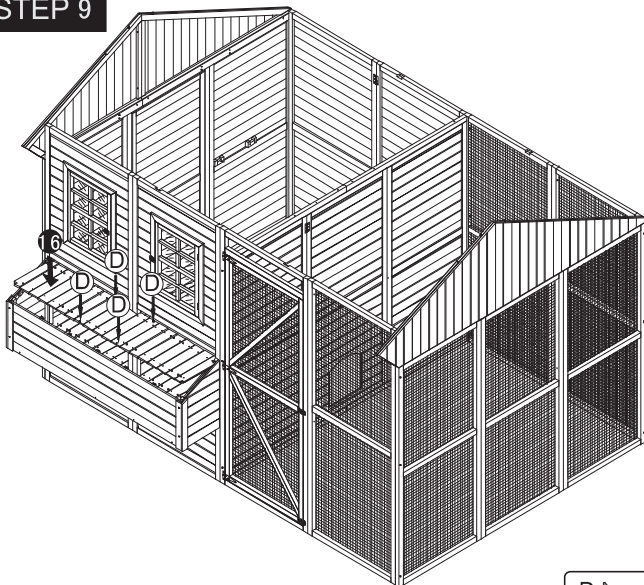

D = 4

STEP 10

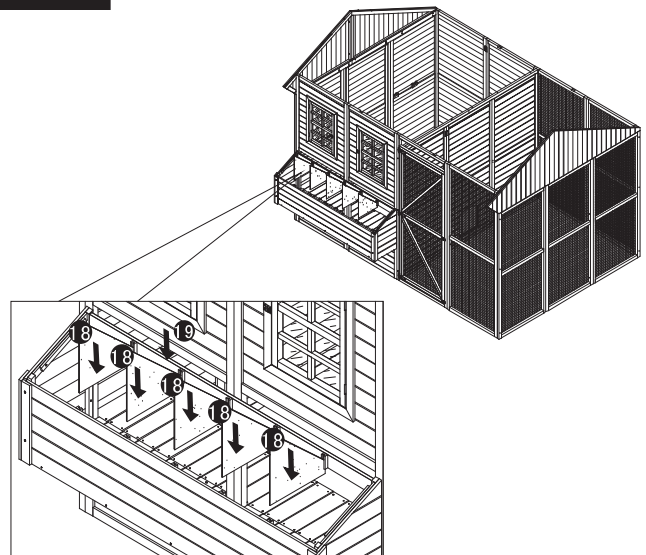



STEP 11

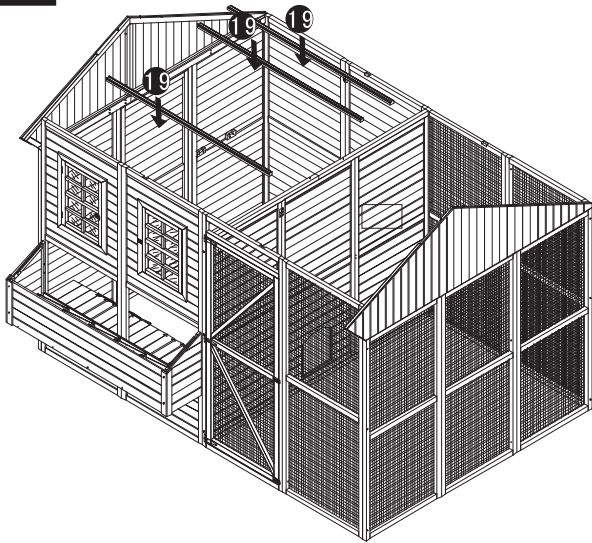

STEP 12

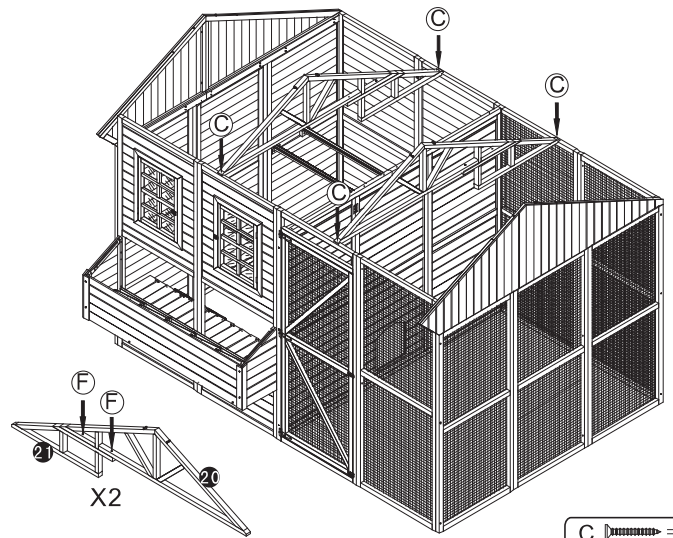

C = 6  
 F = 4

STEP 13

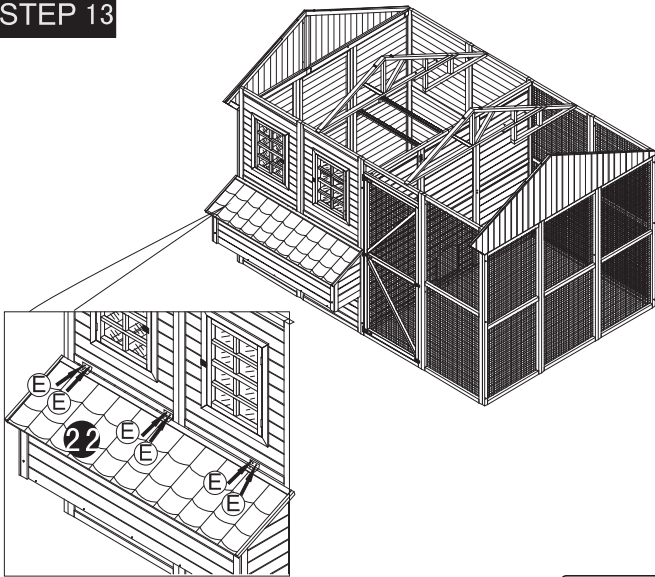

E = 6

STEP 14

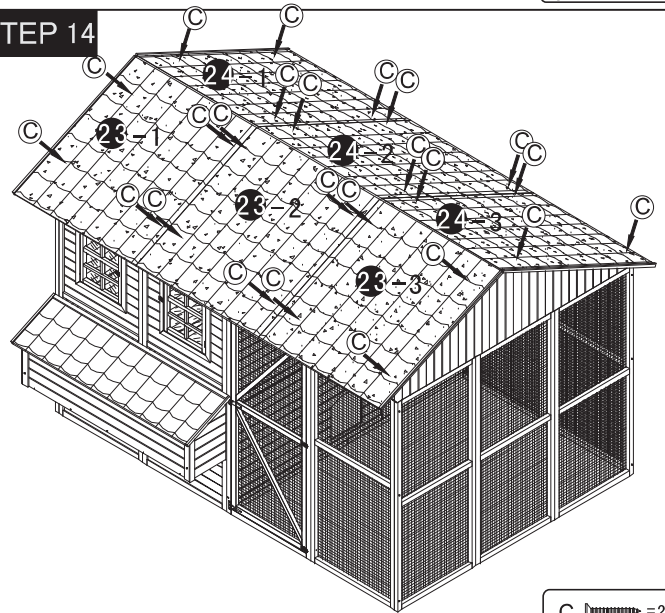

C = 24

STEP 15

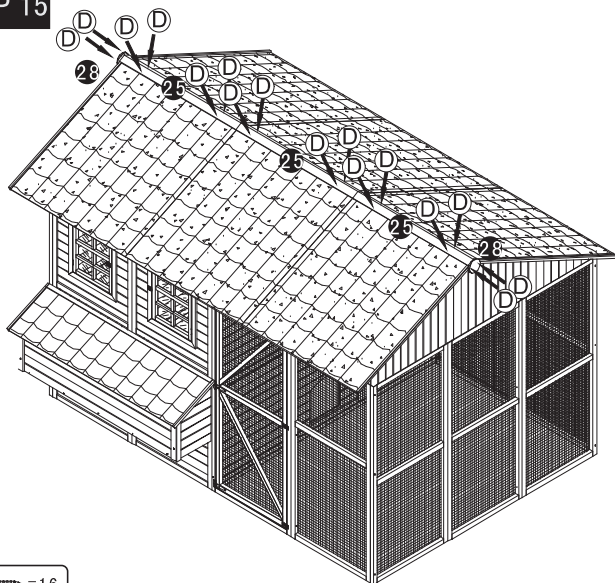

D = 16

STEP 16

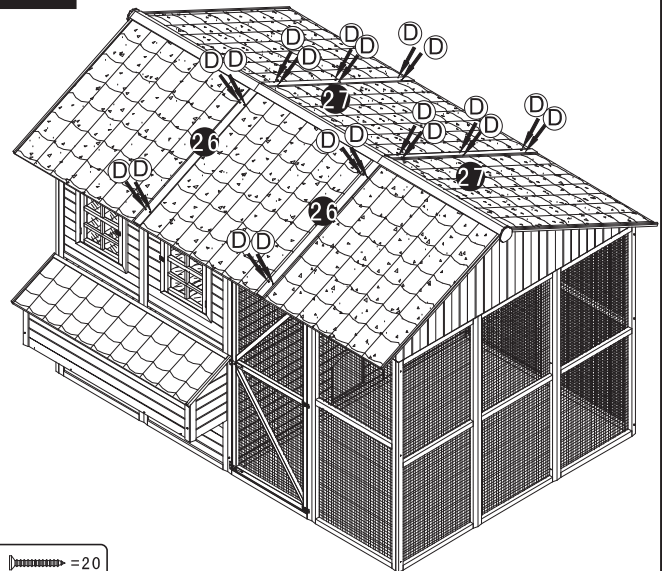

D = 20