

A	3.5*60=36	H	=4
B	3.5*50=48		
C	3.5*45=8		
D	3.5*35=72		
E	3.5*25=58		
F	3.0*16=34		
G	=1		

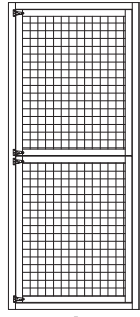

795



1

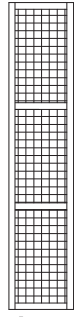

2 x2

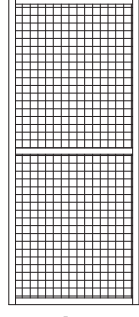

3

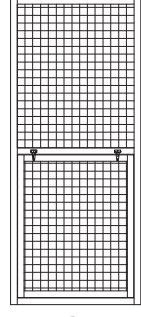

4

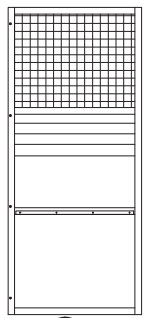

5

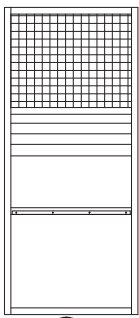

6

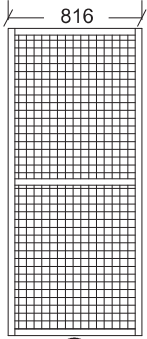

7 x2

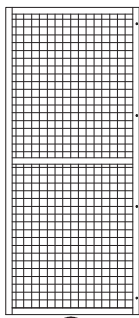

8 x2

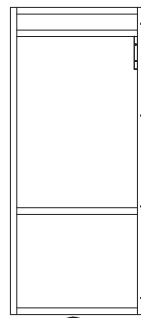

9

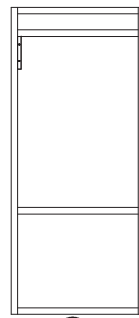

10



11



12

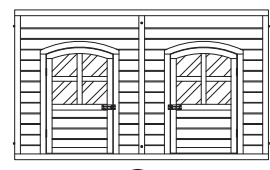

13

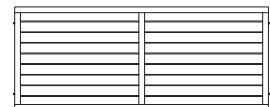

14

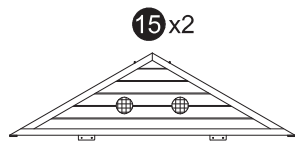

15 x2

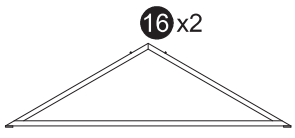

16 x2

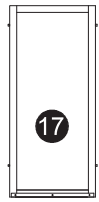

17



23

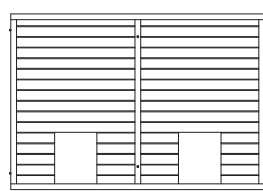

18

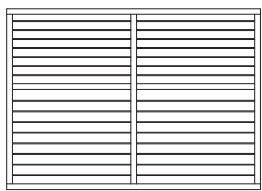

19

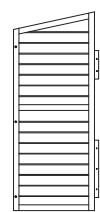

20

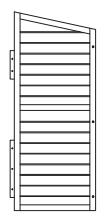

21

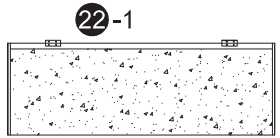

22-1



22-2

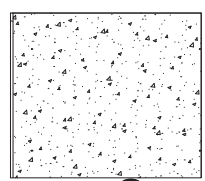

24 x2

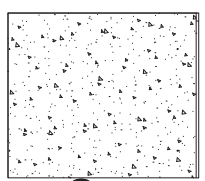

25 x2

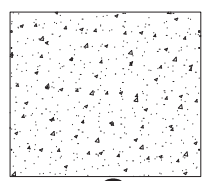

26 x2

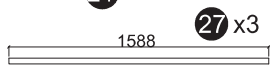

27 x3

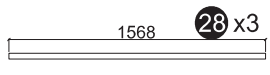

28 x3



29



30 x4



31 x2



32 x2

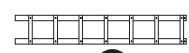

33 x2

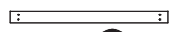

34 x4

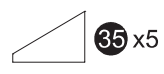

35 x5

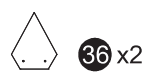

36 x2



37 x4

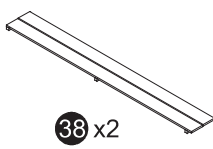

38 x2

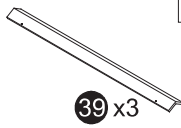

39 x3



41 x2

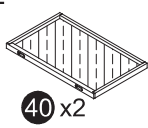

40 x2

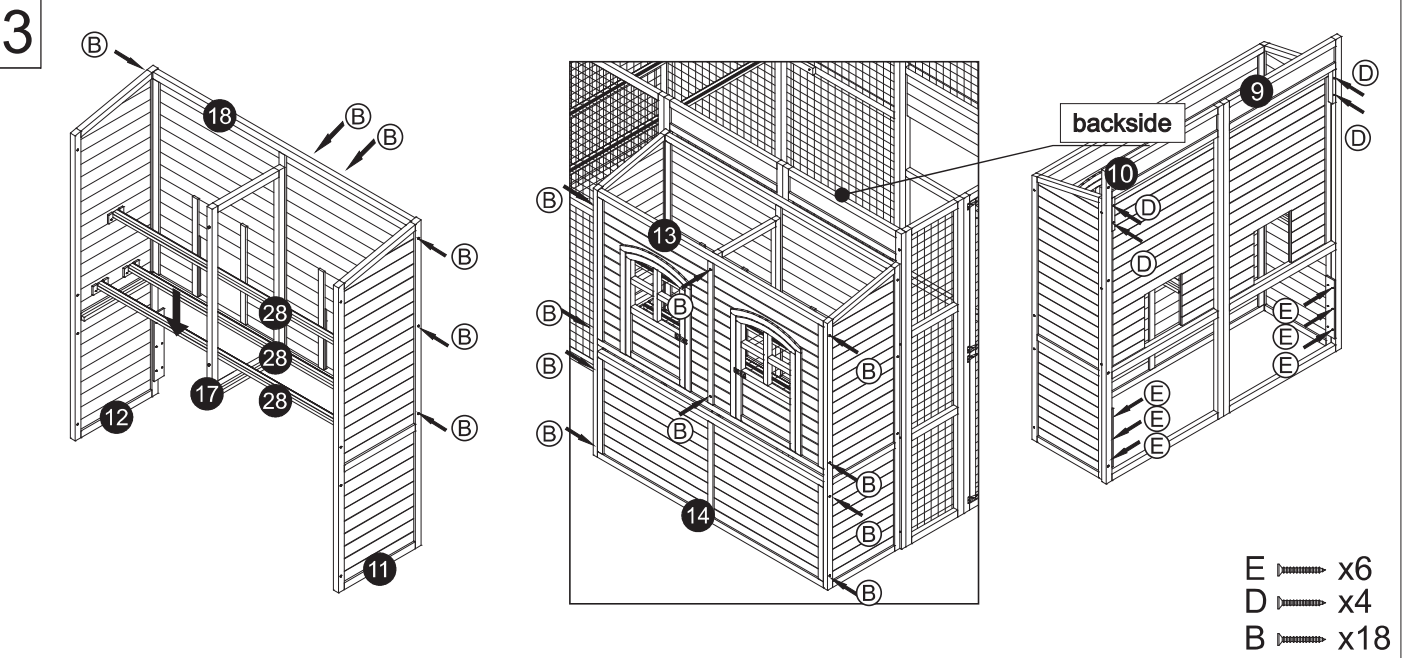
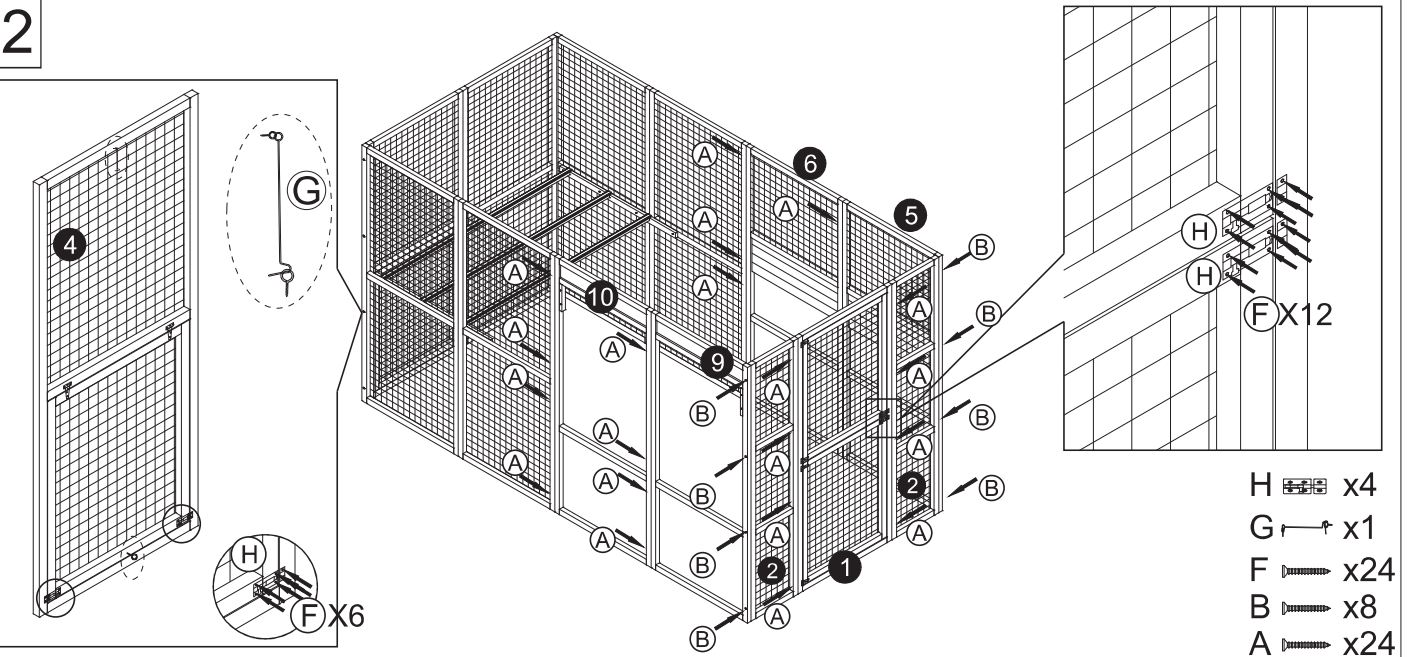
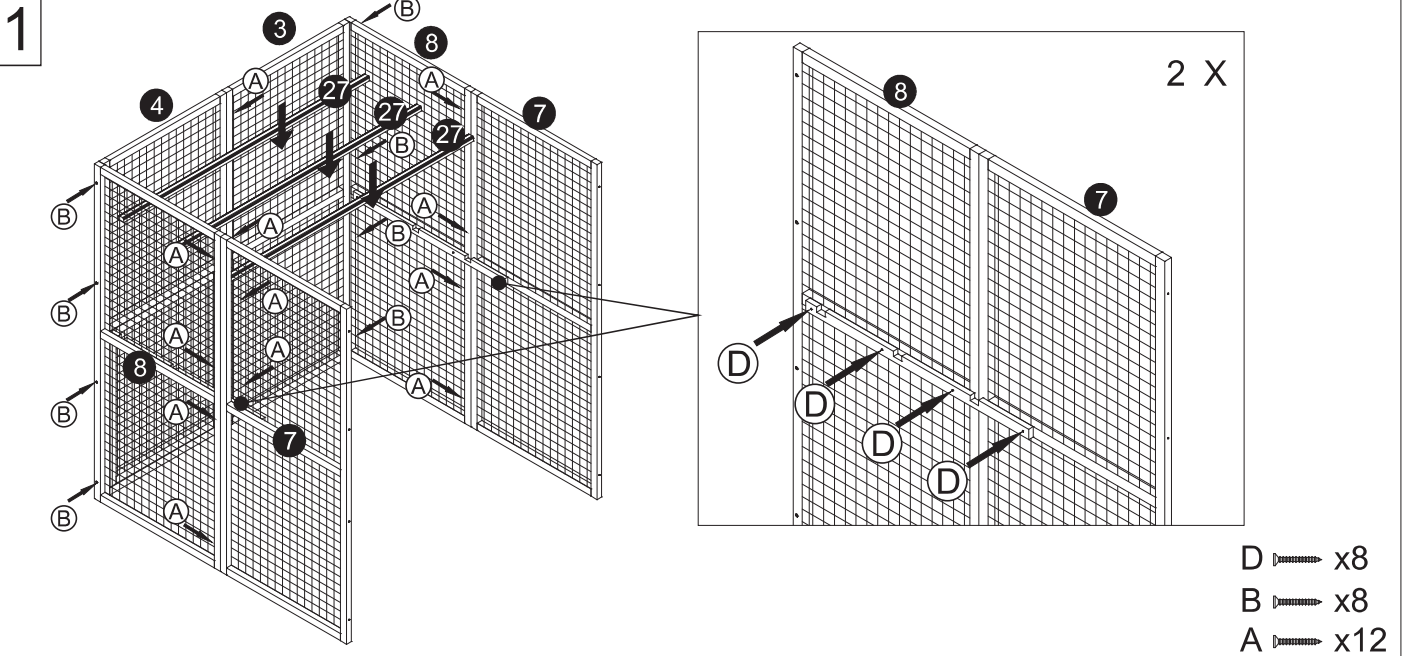

4

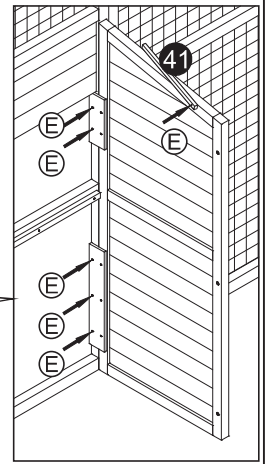
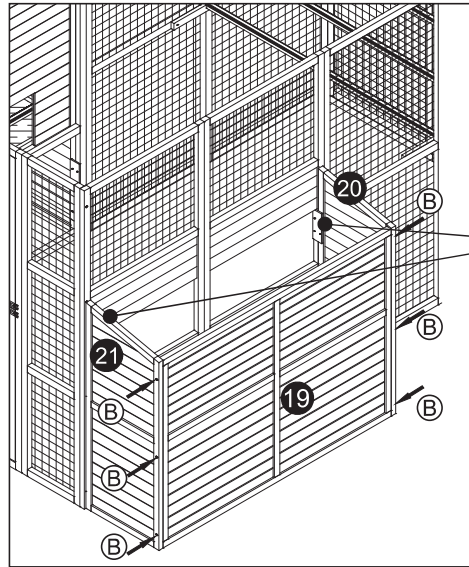
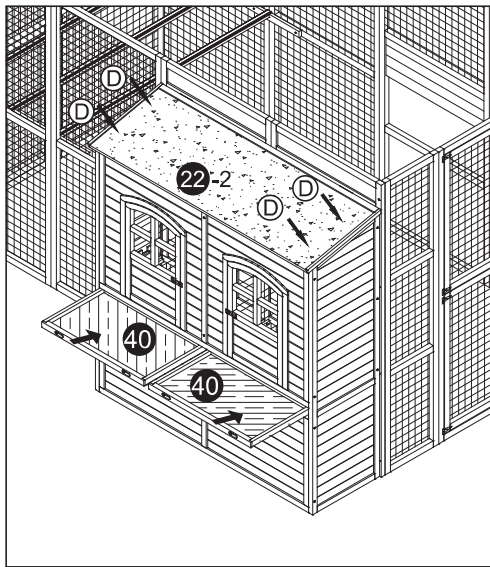

- E x12
- D x4
- B x6

5

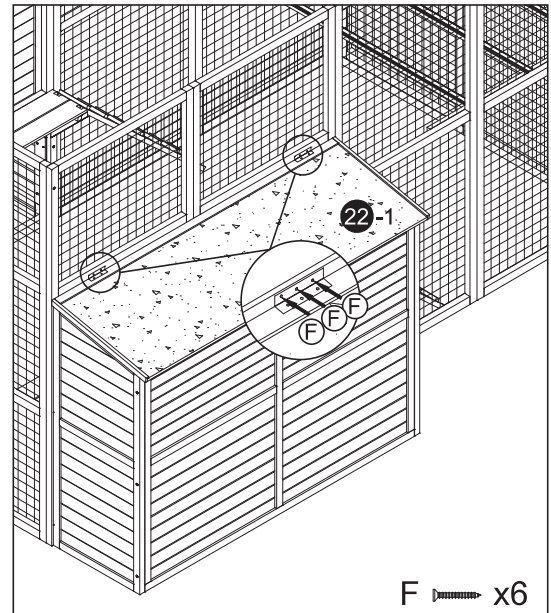
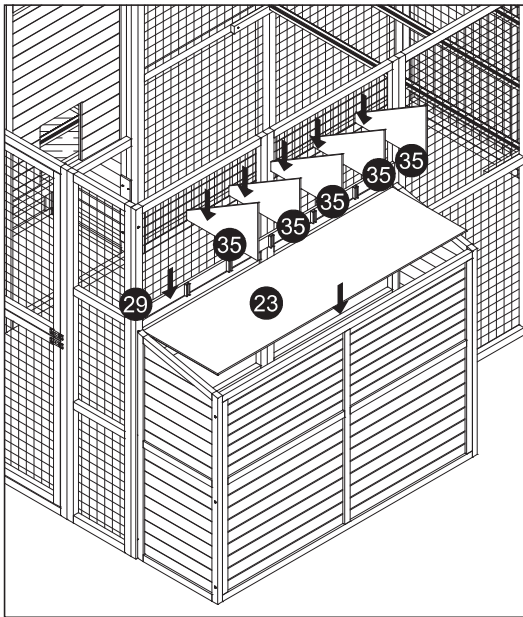

- F x6

6

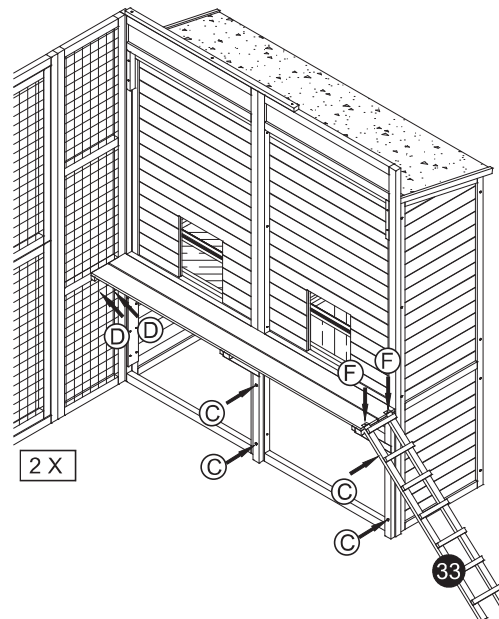
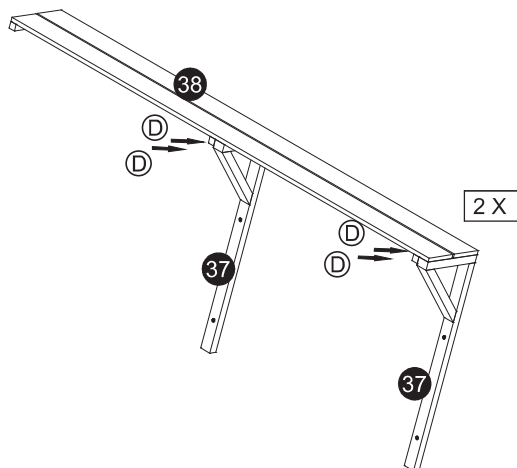

- F x4
- D x12
- C x8



7

7-1

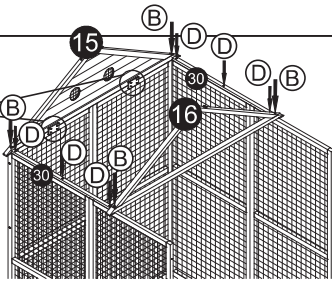

7-2

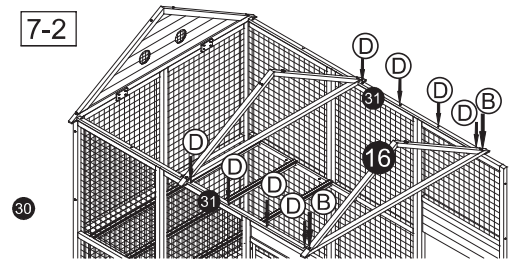

7-3

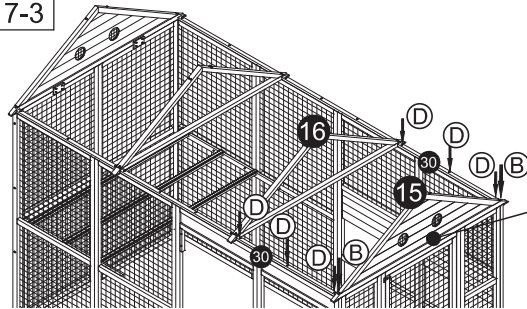

backside



- E x8
- D x20
- B x8

8

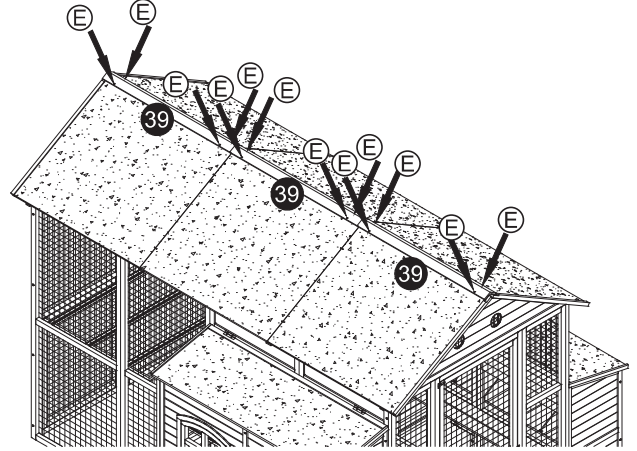
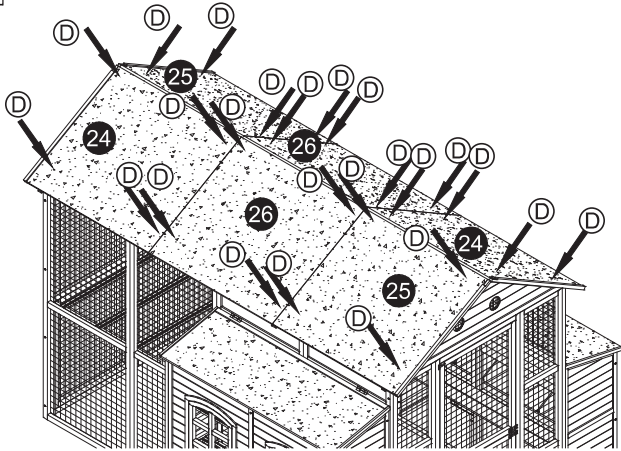

- E x12
- D x24

9

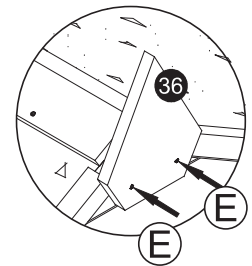
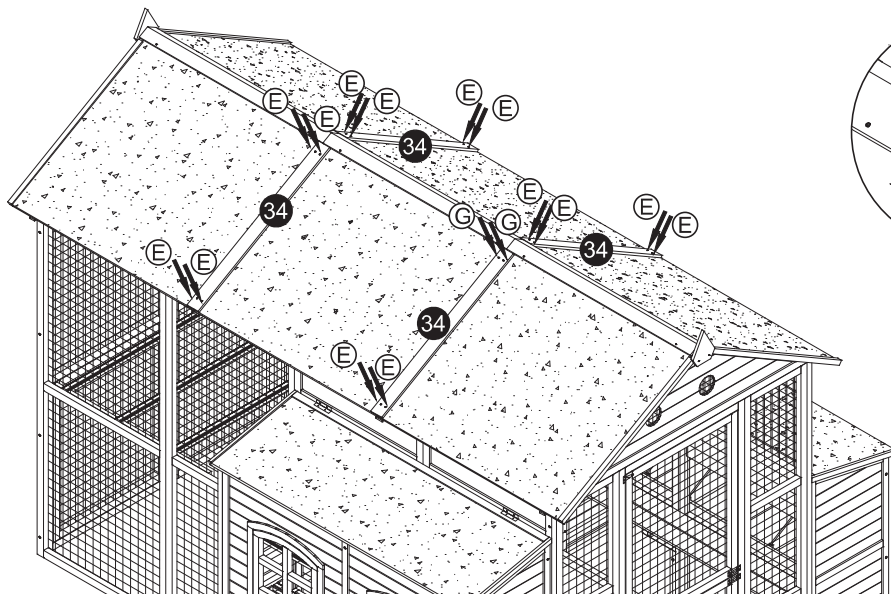

- E x20