

VersaCAMM

Roland DG Corporation

VP-540 / VP-300

USER'S MANUAL

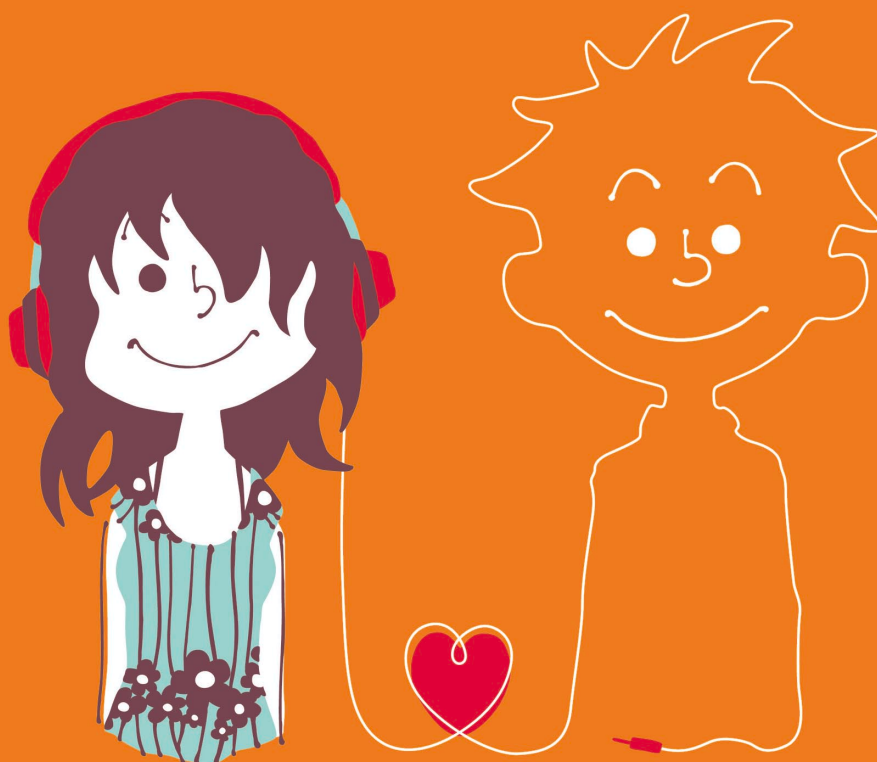

©Koichi Taniguchi

My Creative Printer

Thank you very much for purchasing this product.

- To ensure correct and safe usage with a full understanding of this product's performance, please be sure to read through this manual completely and store it in a safe location.
- Unauthorized copying or transferral, in whole or in part, of this manual is prohibited.
- The contents of this document and the specifications of this product are subject to change without notice.
- The documentation and the product have been prepared and tested as much as possible. If you find any misprint or error, please inform us.
- Roland DG Corp. assumes no responsibility for any direct or indirect loss or damage which may occur through use of this product, regardless of any failure to perform on the part of this product.
- Roland DG Corp. assumes no responsibility for any direct or indirect loss or damage which may occur with respect to any article made using this product.

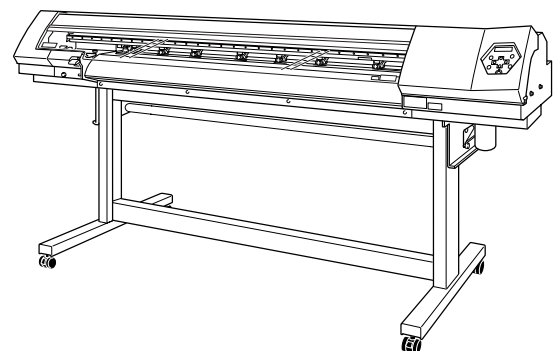

For the USA

**FEDERAL COMMUNICATIONS COMMISSION
RADIO FREQUENCY INTERFERENCE
STATEMENT**

This equipment has been tested and found to comply with the limits for a Class A digital device, pursuant to Part 15 of the FCC Rules.

These limits are designed to provide reasonable protection against harmful interference when the equipment is operated in a commercial environment.

This equipment generates, uses, and can radiate radio frequency energy and, if not installed and used in accordance with the instruction manual, may cause harmful interference to radio communications.

Operation of this equipment in a residential area is likely to cause harmful interference in which case the user will be required to correct the interference at his own expense.

Unauthorized changes or modification to this system can void the users authority to operate this equipment.

For Canada

CLASS A NOTICE

This Class A digital apparatus meets all requirements of the Canadian Interference-Causing Equipment Regulations.

CLASSE A AVIS

Cet appareil numérique de la classe A respecte toutes les exigences du Règlement sur le matériel brouilleur du Canada.

NOTICE

Grounding Instructions

Do not modify the plug provided—if it will not fit the outlet, have the proper outlet installed by a qualified electrician.

Check with qualified electrician or service personnel if the grounding instructions are not completely understood, or if in doubt as to whether the tool is properly grounded.

Use only 3-wire extension cords that have 3-prong grounding plugs and 3-pole receptacles that accept the tool's plug.

Repair or replace damaged or worn out cord immediately.

Operating Instructions

KEEP WORK AREA CLEAN. Cluttered areas and benches invites accidents.

DON'T USE IN DANGEROUS ENVIRONMENT. Don't use power tools in damp or wet locations, or expose them to rain. Keep work area well lighted.

DISCONNECT TOOLS before servicing; when changing accessories, such as blades, bits, cutters, and like.

REDUCE THE RISK OF UNINTENTIONAL STARTING. Make sure the switch is in off position before plugging in.

USE RECOMMENDED ACCESSORIES. Consult the owner's manual for recommended accessories. The use of improper accessories may cause risk of injury to persons.

NEVER LEAVE TOOL RUNNING UNATTENDED.
TURN POWER OFF. Don't leave tool until it comes to a complete stop.



ROLAND DG CORPORATION

1-6-4 Shinmiyakoda, Hamamatsu-shi, Shizuoka-ken, JAPAN 431-2103

MODEL NAME : See the MODEL given on the rating plate.

RELEVANT DIRECTIVE : EC LOW VOLTAGE DIRECTIVE (73/23/EEC)

EC ELECTROMAGNETIC COMPATIBILITY DIRECTIVE (89/336/EEC)

WARNING

This is a Class A product. In a domestic environment this product may cause radio interference in which case the user may be required to take adequate measures.



About the GPL/LGPL software used in this product

Thank you for purchasing our product.

This product is using GNU General Public License (GPL) / GNU Lesser General Public License (LGPL) software. You have the right to acquire, modify, and distribute the source code for this GPL/LGPL software. You can obtain the GPL/LGPL source code used in this product by downloading it from the following website.

URL: <http://www.rolanddg.com/gpl/>

Contents

 To Ensure Safe Use	6
 Pour utiliser en toute sécurité	13
Important Notes on Handling and Use	20
Printer Unit	20
Ink Cartridges	21
Chapter 1 Introduction	23
1-1 Introduction	24
Machine Features	24
About the Notation Used in This Manual	24
1-2 Part Names and Functions	25
Printer Unit	25
Operation Panel	27
Chapter 2 Operation	29
2-1 Switching the Power On and Off	30
Switching the Power On and Off	30
The Power-saving Feature	31
2-2 Loading and Cutting Off Media	32
Loading Media	32
Cutting Off the Media	38
2-3 Settings for the Media Heating System	39
What Is the Media Heating System?	39
Making the Temperature Setting for the Media Heating System	39
General Guide for the Preset Temperatures	40
2-4 Starting Output	41
Getting Ready to Receive Data from a Computer	41
Printing Tests and Cleaning	42
2-5 If Ink Runs Out	43
Checking for Remaining Ink	43
If Ink Runs Out	44
2-6 Performing Cutting	45
To Perform Cutting	45
Performing a Cutting Test	46
Making the Setting for Blade Force	47
Chapter 3 Maintenance and Adjustment	49
3-1 Daily Care and Maintenance	50
Disposing of Discharged Ink	50
Cleaning	52
Care and Maintenance of the Print Heads	52
3-2 When Head Cleaning Is Not Effective	53
Performing More Powerful Cleaning	53
When Powerful Cleaning Is Not Effective	53
3-3 Cleaning the Heads Using the Cleaning Kit	54
When the Cleaning Kit Becomes Necessary	54
How to Perform Cleaning	54
3-4 Replacing Consumable Parts	58
Replacing the Wipers	58
Replacing the Blade	61
Replacing the Separating Knife	63
3-5 When Not in Use for a Prolonged Period	65
Keep Performing Maintenance	65

Chapter 4 Feature Reference	67
4-1 Pausing or Canceling Output	68
Canceling Output Before It Finishes	68
4-2 Setting the Location for Starting Output	69
Setting the Output-start Location	69
4-3 Saving the Printer Settings to Match the Media	70
Saving Optimized Media Settings As Preset Values	70
Loading a Saved Preset	71
Assigning a Name to a Preset	71
4-4 Optimizing Printing or Cutting to Match Media Thickness	72
Adjusting Head Height to Match Media Thickness (54-inch Model Only)	72
Correcting for Misalignment in Bidirectional Printing	73
Correcting for Misalignment in Bidirectional Printing More Precisely	74
Performing Feed Correction to Alleviate Horizontal Bands and the Like	76
Performing Distance Correction During Cutting	77
4-5 Accommodating Various Kinds of Media	78
Using Transparent Media	78
Printing Hard-to-dry Media	78
Preventing Media from Coming Loose	79
Speeding Up Output for Narrow Media	79
Preventing Soiling of the Media and Dot Drop-out During Printing	80
Printing Media That Warps Easily	81
How to Load Sheet Media	82
4-6 Changing How the Printer Operates	84
Executing Environment Matching Automatically	84
Determining What Happens When Ink Runs Out	84
Setting the Interval until Activation of the Sleep Mode	85
Deactivating the Sleep Mode	85
Changing the Menu Language and the Units of Measurement	86
Returning All Settings to Their Initial Values	86
4-7 Changing the Ink-drying Method	87
Switching Off the Print Heater and Dryer	87
Determining How the Media Heating System Operates	87
Drying the Trailing Edge of the Printing Area on the Dryer	88
4-8 Making Various Adjustments for Cutting	89
Making the Cutting Conditions Set on the Machine Take Precedence	89
Fine-tuning the Cutting Conditions	89
Accurately Adjusting the Cutting-in Amount	90
Preventing Pulling of the Media with Undue Force When Performing Cutting Only	91
Correcting Misalignment of the Printing and Cutting Positions	92
4-9 Performing Printing and Cutting Separately	95
To Perform Printing and Cutting Separately	95
Printing with Crop Marks	95
Aligning Automatically and Cutting	96
Aligning Manually and Cutting	97
Correcting Misalignment for Printing and Cutting When Using Crop Marks	99
4-10 Making the Network Settings	101
Setting the IP Address, Subnet Mask, Etc.	101
4-11 Viewing Information about the Media and the System	102
Displaying the Amount of Media Remaining	102
Verifying the Setting for the Amount Remaining Every Time the Media Is Changed	102
Printing the Amount of Remaining Media	103
Viewing the Serial Number, Firmware Version, and Other Information	104
Viewing the Network Settings	104
Printing a System Report	105

4-12 Performing Maintenance	106
Draining Ink and Performing Internal Washing	106
Draining Ink Remaining Inside the Machine	106
4-13 Menu List	108
Main Menu	108
Language and Unit Menu	112
Function Menu	113
Chapter 5 What to Do If	115
5-1 The Machine Doesn't Run	116
The Printer Unit Doesn't Run	116
The Media Heating System Doesn't Warm Up	116
5-2 Attractive Printing or Cutting Is Impossible	117
Printed Results Are Coarse or Contain Horizontal Stripes	117
Colors Are Unstable or Uneven	117
The Media Becomes Soiled When Printed	118
Cutting Is Misaligned or Skewed	118
5-3 The Media Jams	119
The Media Jams	119
5-4 Media Wrinkles or Shrinks, or Feed Is Unstable	120
Media Wrinkles or Shrinks	120
Media Feed Is Not Straight	120
Media Feed Is Not Smooth	120
5-5 The Print Heads Stopped Moving	121
What to Do First	121
If the Heads Still Do Not Move	121
5-6 If a Message Appears	122
5-7 If an Error Message Appears	123
Chapter 6 Specifications	127
6-1 Usable Media	128
Conditions for Usable Media	128
6-2 Printing/Cutting Area	129
Maximum Area	129
Maximum Area When Using Crop Marks	129
The Media-cutoff Location During Continuous Printing	130
6-3 About the Blade	131
6-4 Locations of the Power Rating and Serial Number Labels	132
6-5 Specifications	133



Company names and product names are trademarks or registered trademarks of their respective holders.









To Ensure Safe Use

Improper handling or operation of this machine may result in injury or damage to property. Points which must be observed to prevent such injury or damage are described as follows.

About WARNING and CAUTION Notices

 WARNING	Used for instructions intended to alert the user to the risk of death or severe injury should the unit be used improperly.
 CAUTION	Used for instructions intended to alert the user to the risk of injury or material damage should the unit be used improperly. Note: Material damage refers to damage or other adverse effects caused with respect to the home and all its furnishings, as well to domestic animals or pets.

About the Symbols

	The  symbol alerts the user to important instructions or warnings. The specific meaning of the symbol is determined by the design contained within the triangle. The symbol at left means "danger of electrocution."
	The  symbol alerts the user to items that must never be carried out (are forbidden). The specific thing that must not be done is indicated by the design contained within the circle. The symbol at left means the unit must never be disassembled.
	The  symbol alerts the user to things that must be carried out. The specific thing that must be done is indicated by the design contained within the circle. The symbol at left means the power-cord plug must be unplugged from the outlet.

 **Incorrect operation may cause injury.**

 **WARNING**

 **Be sure to follow the operation procedures described in this documentation. Never allow anyone unfamiliar with the usage or handling of the machine to touch it.**

Incorrect usage or handling may lead to an accident.

 **Keep children away from the machine.**
The machine includes areas and components that pose a hazard to children and may result in injury, blindness, choking, or other serious accident.

 **Never operate the machine while tired or after ingesting alcohol or any medication.**
Operation requires unimpaired judgment. Impaired judgment may result in an accident.

 **Never use the machine for any purpose for which it is not intended, or use the machine in an undue manner that exceeds its capacity.**
Doing so may result in injury or fire.

 **For accessories (optional and consumable items, power cord, and the like), use only genuine articles compatible with this machine.**
Incompatible items may lead to an accident.

 **Before attempting cleaning, maintenance, or attachment or detachment of optional items, disconnect the power cord.**
Attempting such operations while the machine is connected to a power source may result in injury or electrical shock.

 **Never attempt to disassemble, repair, or modify the machine.**
Doing so may result in fire, electrical shock, or injury. Entrust repairs to a trained service technician.

 **CAUTION**

 **Exercise caution to avoid being pinched or becoming caught.**
Inadvertent contact with certain areas may cause the hand or fingers to be pinched or become caught. Use care when performing operations.

 **Never attempt operation while wearing a necktie, necklace, or loose clothing. Bind long hair securely.**
Such items may become caught in the machine, resulting in injury.

 **Conduct operations in a clean, brightly lit location.**
Working in a location that is dark or cluttered may lead to an accident, such as becoming caught in the machine as the result of an inadvertent stumble.

 **Never climb or lean on the machine.**
The machine is not made to support a person. Climbing or leaning on the machine may dislodge components and cause a slip or fall, resulting in injury.

 **Caution: cutting tool**
This machine has an internal tool. To avoid injury, handle the tool with care.

⚠ Danger of electrical short, shock, electrocution, or fire

⚠ WARNING



Connect to an electrical outlet that complies with this machine's ratings (for voltage, frequency, and current).

Incorrect voltage or insufficient current may cause fire or electrical shock.

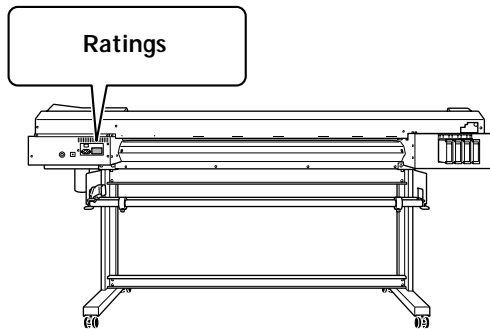

Never use out of doors or in any location where exposure to water or high humidity may occur. Never touch with wet hands. Doing so may result in fire or electrical shock.



Never allow any foreign object to get inside. Never expose to liquid spills.

Inserting objects such as coins or matches or allowing beverages to be spilled into the ventilation ports may result in fire or electrical shock. If anything gets inside, immediately disconnect the power cord and contact your authorized Roland DG Corp. dealer.



Never place any flammable object nearby. Never use a combustible aerosol spray nearby. Never use in any location where gases can accumulate.

Combustion or explosion may be a danger.



Handle the power cord, plug, and electrical outlet correctly and with care. Never use any article that is damaged.

Using a damaged article may result in fire or electrical shock.



When using an extension cord or power strip, use one that adequately satisfies the machine's ratings (for voltage, frequency, and current).

Use of multiple electrical loads on a single electrical outlet or of a lengthy extension cord may cause fire.

⚠ WARNING



Connect to ground.

This can prevent fire or electrical shock due to current leakage in the event of malfunction.



Position so that the power plug is within immediate reach at all times.

This is to enable quick disconnection of the power plug in the event of an emergency. Install the machine next to an electrical outlet. Also, provide enough empty space to allow immediate access to the electrical outlet.



If sparking, smoke, burning odor, unusual sound, or abnormal operation occurs, immediately unplug the power cord. Never use if any component is damaged.

Continuing to use the machine may result in fire, electrical shock, or injury. Contact your authorized Roland DG Corp. dealer.

⚠ Important notes about the power cord, plug, and electrical outlet

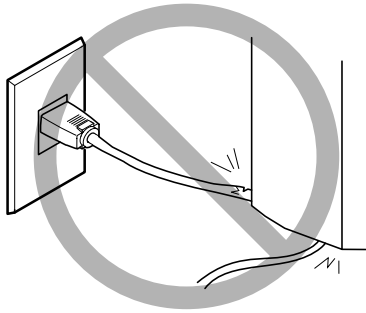

Never place any object on top or subject to damage.

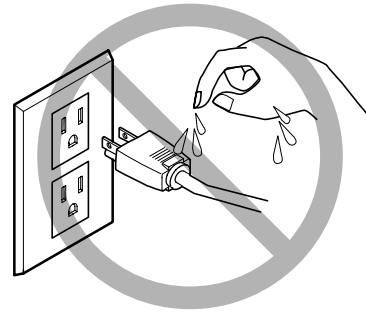

Never allow to get wet.

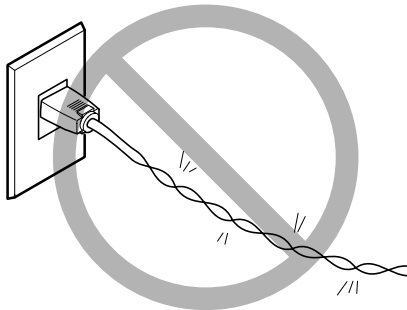

Never bend or twist with undue force.

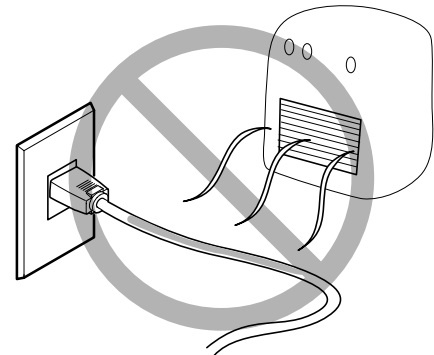

Never make hot.

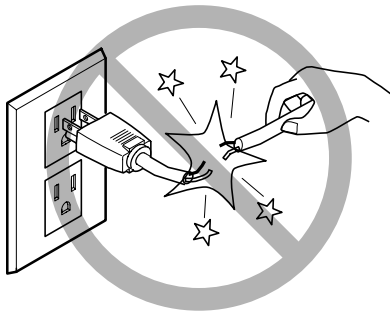

Never pull with undue force.

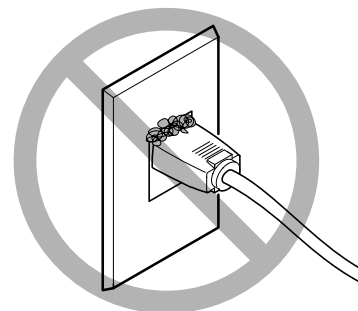

Dust may cause fire.

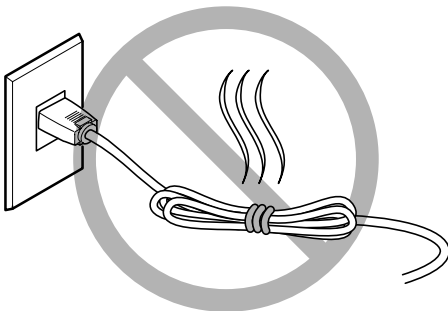

Never bundle, bind, or roll up.

 **Ink, cleaning fluid, and discharged fluid are flammable and toxic.**

 **WARNING**



If you're using a model that uses ECO-SOL MAX ink, keep open flame away from the work area. Keep open flame away from the work area.

Ink and discharged fluid are flammable.



Never store ink, cleaning fluid, or discharged fluid in any of the following locations.

- Any location exposed to open flame
- Any location where high temperature may occur
- Near bleach or any other such oxidizing agent or explosive material
- Any location within the reach of children

Fire may be a danger. Accidental ingestion by children may pose a health hazard.



Never place an ink cartridge in fire.

Ink may flow out, catch fire, and spread fire to other nearby objects.



Never drink or sniff ink, cleaning fluid, or discharged fluid, or allow them to come in contact with the eyes or skin.

Doing so may be hazardous to the health.

 **CAUTION**



Ensure adequate ventilation for the work area.

Failing to perform ventilation may result in a health hazard or danger of combustion due to ink fumes.



Never allow an ink cartridge to be subjected to impact, and never attempt to disassemble.

Ink may leak.

 **In the event of ingestion or physical distress**

- In the event of contact with the eyes, immediately flush with water for at least 15 minutes. If eye irritation continues, seek treatment by a physician.
- In the event of contact with skin, immediately wash with soap. If irritation or inflammation occur, seek treatment by a physician.
- In the event of ingestion, do not induce vomiting, and immediately seek treatment by a physician. Forcibly inducing vomiting may lead to danger of choking.
- If odor leads to physical distress, move to a well-ventilated location and rest quietly. If dizziness or nausea persists, seek treatment by a physician.

 This machine weighs 160 kg (353 lb.). Media weighs 30 kg (66 lb.).

WARNING

 **Install the machine in a location that is level, stable, and able to bear the weight of the machine.**

The total weight of the machine may reach 160 kg (353 lb.) or more (120 kg (265 lb.) or more for the 30-inch model). Installation in an unsuitable location may cause a major accident, including tipover, fall, or collapse.

 **Unloading and emplacement are operations that must be performed by six persons or more (by four persons or more for the 30-inch model).**

Tasks that require undue effort when performed by a small number of persons may result in physical injury. Also, if dropped, such items may cause injury.

WARNING

 **Be sure to lock the stand's casters.**
If the machine should begin to topple, a major accident may result, including crushing of the appendages or the body.

 **When storing roll media, implement adequate safety measures to ensure that the stored media will not roll, fall, or topple over.**

Danger exists of becoming pinned under the media and suffering serious injury.

 **Handling roll media is an operation that must be performed by two persons or more, and care must be taken to prevent falls.**

Attempting to lift heavy media in a manner that taxes your strength may cause physical injury.

 **Danger of fire, burns, or toxic gas emissions**

WARNING

 **Caution: high temperatures**
Areas such as the dryer become hot. Exercise caution to avoid fire or burns.

 **When printing is not being performed, remove any loaded media or switch off the power.**

The continued application of heat at a single location may cause the release of toxic gases from the media or pose a fire hazard.

WARNING

 **Never use media that cannot withstand heat.**

Doing so may degrade the media, or may result in fire or the release of toxic gases.

⚠ Warning Labels

Warning labels are affixed to make areas of danger immediately clear. The meanings of these labels are as follows. Be sure to heed their warnings.

Also, never remove the labels or allow them to become obscured.

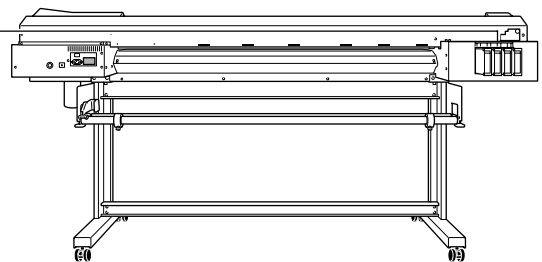
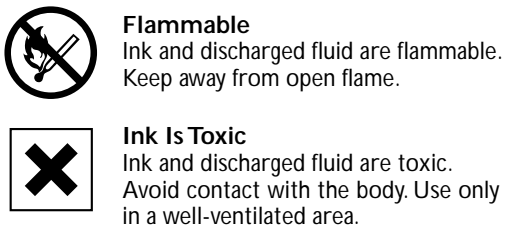
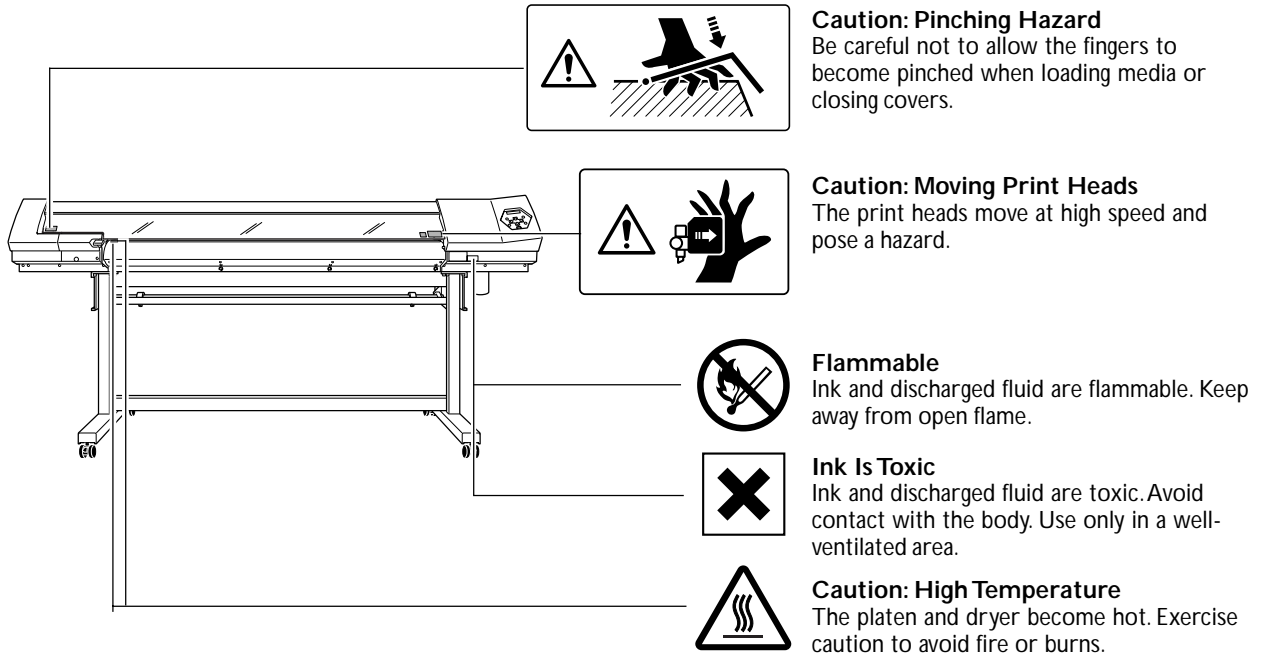







Pour utiliser en toute sécurité

La manipulation ou l'utilisation inadéquates de cet appareil peuvent causer des blessures ou des dommages matériels. Les précautions à prendre pour prévenir les blessures ou les dommages sont décrites ci-dessous.

Avis sur les avertissements

 ATTENTION	Utilisé pour avertir l'utilisateur d'un risque de décès ou de blessure grave en cas de mauvaise utilisation de l'appareil.
 PRUDENCE	Utilisé pour avertir l'utilisateur d'un risque de blessure ou de dommage matériel en cas de mauvaise utilisation de l'appareil. * Par dommage matériel, il est entendu dommage ou tout autre effet indésirable sur la maison, tous les meubles et même les animaux domestiques.

À propos des symboles

	Le symbole \triangle attire l'attention de l'utilisateur sur les instructions importantes ou les avertissements. Le sens précis du symbole est déterminé par le dessin à l'intérieur du triangle. Le symbole à gauche signifie "danger d'électrocution."
	Le symbole \otimes avertit l'utilisateur de ce qu'il ne doit pas faire, ce qui est interdit. La chose spécifique à ne pas faire est indiquée par le dessin à l'intérieur du cercle. Le symbole à gauche signifie que l'appareil ne doit jamais être démonté.
	Le symbole \bullet prévient l'utilisateur sur ce qu'il doit faire. La chose spécifique à faire est indiquée par le dessin à l'intérieur du cercle. Le symbole à gauche signifie que le fil électrique doit être débranché de la prise.

Ce document est le guide d'installation pour les appareils VP-540 et VP-300. Dans le document, les noms suivants sont utilisés pour établir la différence entre les deux modèles, lorsque c'est nécessaire.

VP-540 — Modèle de 54 po

VP-300 — Modèle de 30 po

L'utilisation incorrecte peut causer des blessures

ATTENTION

 **S'assurer de suivre les procédures d'utilisation décrites dans la documentation. Ne jamais permettre à quiconque ne connaît pas le fonctionnement ou la manutention de l'appareil de le toucher.**
L'utilisation ou la manutention incorrectes peuvent causer un accident.

 **Garder les enfants loin de l'appareil.**
L'appareil comporte des zones et des composants qui présentent un danger pour les enfants et qui pourraient causer des blessures, la cécité, la suffocation ou d'autres accidents graves.

 **Ne jamais faire fonctionner l'appareil après avoir consommé de l'alcool ou des médicaments, ou dans un état de fatigue.**
L'utilisation de l'appareil exige un jugement sans faille. L'utilisation avec les facultés affaiblies pourrait entraîner un accident.

 **Ne jamais utiliser l'appareil à des fins autres que celles pour lesquelles il est conçu. Ne jamais l'utiliser de manière abusive ou d'une manière qui dépasse sa capacité.**
Le non-respect de cette consigne peut causer des blessures ou un incendie.

 **Utiliser uniquement des accessoires d'origine (accessoires en option, articles consommables, câble d'alimentation et autres articles semblables), compatibles avec l'appareil.**
Les articles incompatibles risquent de causer des accidents.

 **Débrancher le câble d'alimentation avant de procéder au nettoyage ou à l'entretien de l'appareil, et avant d'y fixer ou d'en retirer des accessoires en option.**
Tenter ces opérations pendant que l'appareil est branché à une source d'alimentation peut causer des blessures ou un choc électrique.

 **Ne jamais tenter de démonter, de réparer ou de modifier l'appareil.**
Le non-respect de cette consigne risque de provoquer un incendie, un choc électrique ou des blessures. Confier les réparations à un technicien ayant la formation requise.

PRUDENCE

 **Faire preuve de prudence pour éviter l'écrasement ou le coincement.**
La main ou les doigts peuvent être écrasés ou coincés s'ils entrent en contact avec certaines surfaces par inadvertance. Faire preuve de prudence pendant l'utilisation de l'appareil.

 **Ne jamais faire fonctionner l'appareil si on porte une cravate, un collier ou des vêtements amples. Bien attacher les cheveux longs.**
Ces vêtements ou ces objets peuvent être coincés dans l'appareil, ce qui causerait des blessures.

 **Utiliser l'appareil dans un endroit propre et bien éclairé.**
Travailler dans un endroit sombre ou encombré peut causer un accident; l'utilisateur risque, par exemple, de trébucher malencontreusement et d'être coincé par une partie de l'appareil.

 **Ne jamais grimper ni s'appuyer sur la machine.**
La machine n'est pas conçue pour supporter le poids d'une personne. Grimper ou s'appuyer sur la machine peut déplacer des éléments et causer un faux pas ou une chute, ce qui causerait des blessures.

 **Attention : outil de coupe.**
Cet appareil contient un outil interne. Pour éviter les blessures, manipuler l'outil avec soin.

⚠ Risque de décharge ou de choc électrique, d'électrocution ou d'incendie

⚠ ATTENTION



Brancher à une prise électrique conforme aux caractéristiques de cet appareil (tension, fréquence et courant).

Une tension incorrecte ou un courant insuffisant peuvent causer un incendie ou un choc électrique.

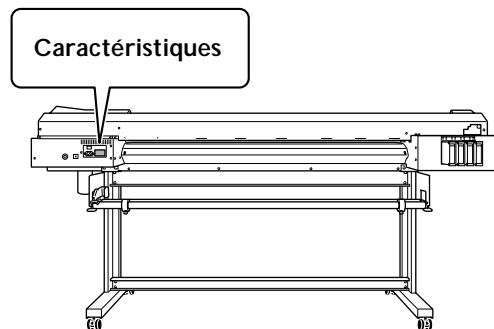

Ne jamais utiliser à l'extérieur ni à un endroit où l'appareil risque d'être exposé à de l'eau ou à une humidité élevée. Ne jamais toucher l'appareil avec des mains mouillées.

Le non-respect de cette consigne risque de provoquer un incendie ou un choc électrique.



Ne jamais insérer d'objet étranger dans l'appareil. Ne jamais exposer l'appareil aux déversements de liquides.

L'insertion d'objets comme des pièces de monnaie ou des allumettes, ou le déversement de liquides dans les orifices de ventilation peuvent causer un incendie ou un choc électrique. Si un objet ou du liquide s'infiltré dans l'appareil, débrancher immédiatement le câble d'alimentation et communiquer avec le représentant Roland DG Corp. autorisé.



Ne jamais placer d'objet inflammable à proximité de l'appareil. Ne jamais utiliser de produit inflammable en aérosol à proximité de l'appareil. Ne jamais utiliser l'appareil dans un endroit où des gaz peuvent s'accumuler.

Une combustion ou une explosion pourraient se produire.

⚠ ATTENTION



Manipuler le câble d'alimentation, la fiche et la prise électrique correctement et avec soin.

Ne jamais utiliser un article endommagé, car cela pourrait causer un incendie ou un choc électrique.



Si une rallonge ou une bande d'alimentation électrique sont utilisées, s'assurer qu'elles correspondent aux caractéristiques de l'appareil (tension, fréquence et courant).

L'utilisation de plusieurs charges électriques sur une prise unique ou une longue rallonge peut causer un incendie.



Mise à la terre.

La mise à la terre peut prévenir un incendie ou un choc électrique dus à une fuite de courant en cas de défaillance.



Placer l'appareil de façon à ce que la fiche soit facile d'accès en tout temps.

Ainsi, l'appareil pourra être débranché rapidement en cas d'urgence. Installer l'appareil près d'une prise électrique. En outre, prévoir suffisamment d'espace pour que la prise électrique soit facile d'accès.



S'il se produit des étincelles, de la fumée, une odeur de brûlé, un bruit inhabituel ou un fonctionnement anormal, débrancher immédiatement le câble d'alimentation. Ne jamais utiliser si un composant est endommagé.

Continuer à utiliser l'appareil peut causer un incendie, un choc électrique ou des blessures. Communiquer avec le représentant Roland DG Corp. Autorisé.

⚠ Remarques importantes à propos du câble d'alimentation, de la fiche et de la prise électrique

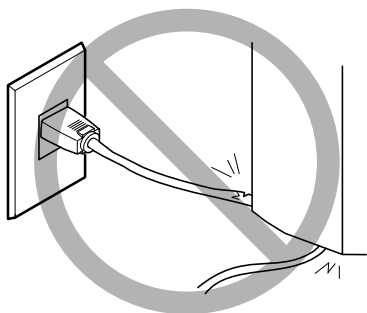

Ne jamais déposer aucun objet sur le câble, sur la fiche ou sur la prise car cela risque de les endommager.

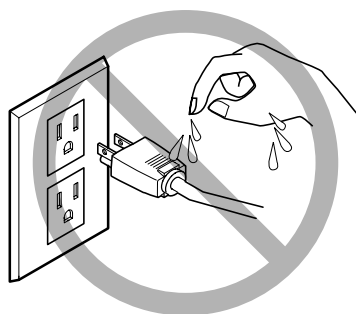

Ne jamais laisser l'eau toucher le câble, la fiche ou la prise.

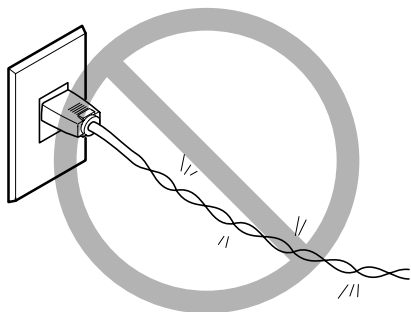

Ne jamais plier ni tordre le câble avec une force excessive.

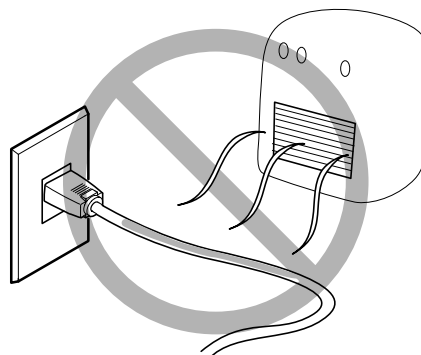

Ne jamais chauffer le câble, la fiche ou la prise.

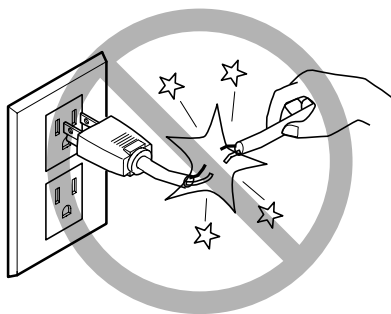

Ne jamais tirer sur le câble ou la fiche avec une force excessive.

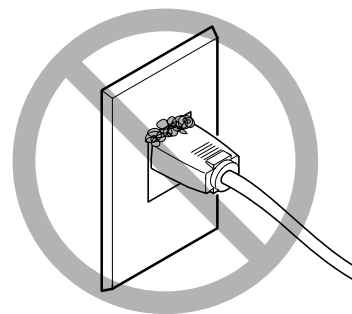

La poussière peut causer un incendie.

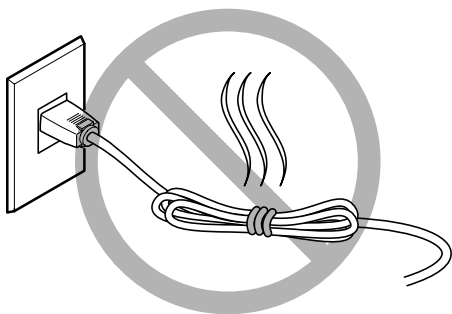

Ne jamais plier ni enrouler le câble.

⚠ L'encre, les liquides nettoyants et les liquides usés sont inflammables et toxiques

⚠ ATTENTION



S'il s'agit d'un modèle qui utilise l'encre ECO-SOL MAX, ne pas approcher une flamme nue de l'espace de travail.
L'encre et les liquides usés sont inflammables.



Ne jamais entreposer d'encre, de liquide de nettoyage ou des liquides usés dans les endroits suivants :

- un endroit exposé à une flamme nue;
- un endroit où il y a risque de température élevée;
- près d'eau de Javel, d'un autre agent d'oxydation ou de matériel explosif;
- tout endroit à la portée d'enfants.

Il y a risque d'incendie. L'ingestion accidentelle par un enfant peut présenter un risque pour la santé.



Ne jamais incinérer une cartouche d'encre.
De l'encre pourrait couler, s'enflammer et le feu se répandre à des objets proches.



Ne jamais boire l'encre, le liquide de nettoyage ni les liquides usés, ne pas en respirer les vapeurs et ne pas laisser les produits entrer en contact avec les yeux ou la peau.
Cela est dangereux pour la santé.

⚠ PRUDENCE



S'assurer que le lieu de travail est bien aéré.
L'absence d'aération adéquate peut créer une situation dangereuse pour la santé ou un risque de combustion à cause des vapeurs qui émanent de l'encre.



Ne jamais soumettre une cartouche d'encre à des chocs. Ne jamais tenter d'ouvrir une cartouche d'encre.
De l'encre pourrait s'échapper.

⚠ En cas d'ingestion ou de trouble physique

- En cas de contact avec les yeux : rincer immédiatement et abondamment à l'eau courante pendant au moins 15 minutes. Si les yeux sont toujours irrités, consulter un médecin.
- En cas de contact avec la peau : laver immédiatement à l'eau et au savon. En cas d'irritation ou d'inflammation de la peau : consulter un médecin.
- En cas d'ingestion : ne pas provoquer le vomissement et demander immédiatement l'aide d'un médecin. Provoquer le vomissement peut créer un risque de suffocation.
- Si l'odeur cause un trouble physique, amener la personne dans un endroit bien aéré et la faire se reposer. Si l'étourdissement ou la nausée persistent, consulter un médecin.

 **Le poids de cet appareil est de 160 kg (353 lb.)
Le poids du support est de 30 kg (66 lb.)**

ATTENTION



Installer l'appareil à un endroit stable et plat et capable de supporter son poids.

Le poids total de l'appareil peut être de 160 kg (353 lb.) ou plus (120 kg (265 lb.) ou plus pour le modèle de 30 po). Installer l'appareil à un endroit inapproprié peut provoquer un accident grave comme le renversement, la chute ou l'écrasement.



Le déchargement et la mise en place doivent être faits par au moins six personnes (quatre personnes ou plus pour le modèle de 30 po).

Les tâches qui exigent un effort trop grand si elles sont exécutées par un petit nombre de personnes peuvent être cause de blessures. La chute d'articles très lourds peut aussi causer des blessures.

ATTENTION



S'assurer de verrouiller les roulettes de la base.

Si l'appareil devait commencer à basculer, il s'ensuivrait un accident grave, par exemple l'écrasement de membres ou du corps.



Prendre les mesures de sécurité adéquates pour l'entreposage des rouleaux de support pour s'assurer qu'ils ne rouleront pas, ne tomberont pas et ne se renverseront pas.

Il y a risque d'être écrasé par le support et de subir des blessures graves.



La manutention du support en rouleau doit être faite par deux personnes ou plus et il faut prendre des précautions pour éviter les chutes.

Tenter de soulever des objets trop lourds peut causer des blessures.

 **Risque d'incendie, de brûlures ou d'émissions de gaz toxiques**

ATTENTION



Attention : températures élevées.

Les zones comme le séchoir chauffent. Faire preuve de prudence pour éviter un incendie ou des brûlures.



Quand aucun travail d'impression n'est en cours, retirer tout support de l'appareil ou couper l'alimentation électrique.

L'application continue de chaleur à un point unique peut causer l'émission de gaz toxiques ou créer un risque d'incendie.

ATTENTION



Ne jamais utiliser un support qui ne peut pas supporter la chaleur.

L'utilisation d'un support qui ne supporte pas la chaleur peut détériorer le support, créer un risque d'incendie ou causer l'émission de gaz toxiques.

⚠ Vignettes d'avertissement

Des vignettes d'avertissement sont apposées pour qu'il soit facile de repérer les zones dangereuses. La signification des vignettes est donnée ci-dessous. Respecter les avertissements. Ne jamais retirer les vignettes et ne pas les laisser s'encrasser.

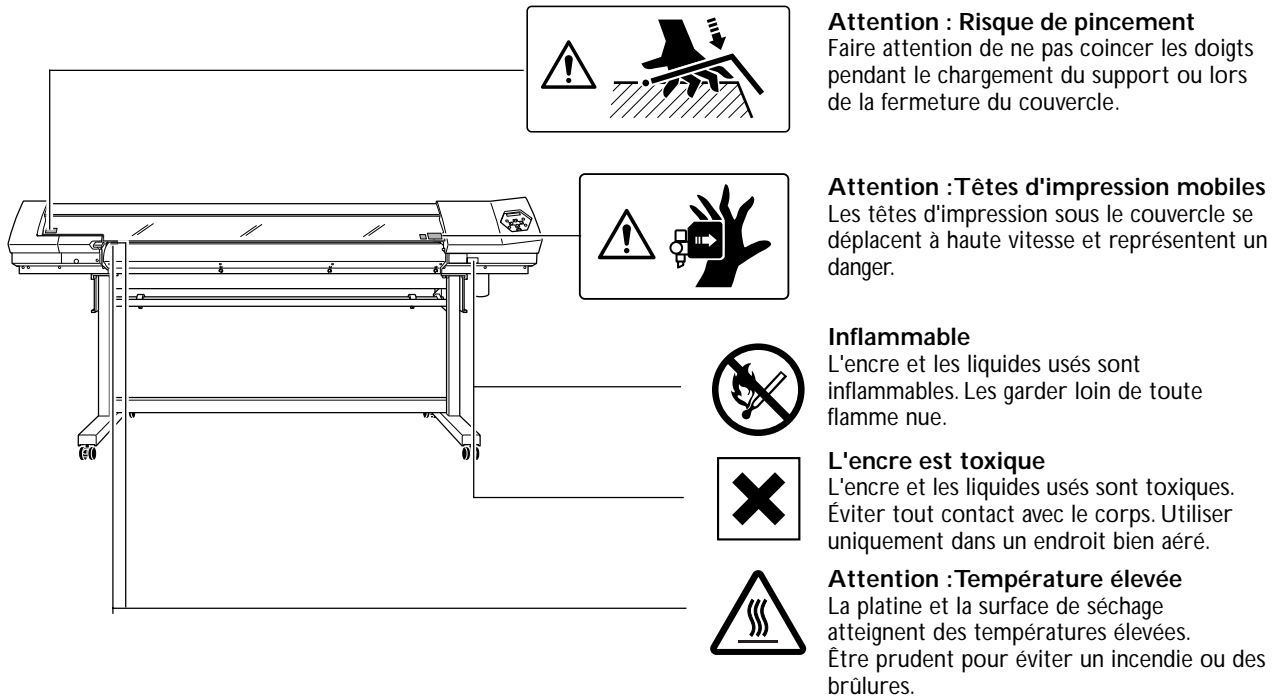

Inflammable

L'encre et les liquides usés sont inflammables. Les garder loin de toute flamme nue.



L'encre est toxique

L'encre et les liquides usés sont toxiques. Éviter tout contact avec le corps. Utiliser uniquement dans un endroit bien aéré.

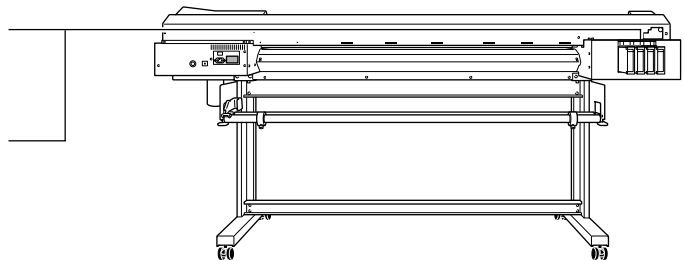

Important Notes on Handling and Use

This machine is a precision device. To ensure the full performance of this machine, be sure to observe the following important points. Failure to observe them may not only result in loss of performance, but may also cause malfunction or breakdown.

Printer Unit

This machine is a precision device.

- Handle carefully, and never subject the machine to impact or excessive force.
- Never needlessly put your hand or fingers inside the cover, the ink-cartridge ports, or other internal areas of the machine.

Install in a suitable location.

- Install in a location having the specified temperature and relative humidity.
- Install in a quiet, stable location offering good operating conditions.

The print heads are delicate.

- Never needlessly touch or allow media to scrape them. Failure to handle with care may cause damage.
- The print heads may be damaged if allowed to dry out. The machine prevents desiccation automatically, but improper operation may render this feature inoperative. Operate properly, as specified in this manual.
- Never allow the machine to stand with an ink cartridge removed. Remaining ink in the printer may harden and clog the print heads.
- The print heads are components that wear out. Periodic replacement is required, with the frequency of replacement depending on use.

This machine becomes hot.

- Never cover the ventilation holes with cloth, tape, or anything else.

Ink Cartridges

Ink cartridges come in various types.

- Use a type that is compatible with the printer. Also, be sure to use only genuine items from Roland DG Corp.

Never subject to impact or attempt to disassemble.

- Never drop or shake forcefully. The impact may rupture the internal pouch and cause the ink to leak.
- Never attempt to disassemble.
- Never attempt to refill the ink.
- If ink gets on your hands or clothing, wash it off as soon as possible. Removal may become difficult if allowed to stand.

Storage

- Store unopened in a well-ventilated location at a temperature of -20 to 40°C (-4 to 104°F).

Chapter 1

Introduction

1-1 Introduction

Machine Features

This is a signmaking machine that adds cutting features to a printer capable of high image quality, for a machine that can accommodate a wide variety of uses, ranging from the creation of stickers and cut-out text and small-lot label printing to the production of panels, outdoor signs, and more.

- This makes possible not only use as either a printer or a cutting machine, but also enables consecutive printing and cutting. Using the crop-mark feature makes it possible to perform alignment and carry out cutting when you want to reload printed media that has been detached for lamination or the like.
- A built-in print server enables direct connection to a network.
- This machine has a built-in media heating system composed of a print heater to improve ink adhesion and speed up drying and a dryer to speed up drying of the media after printing. This enhances productivity by enabling support for more types of media.
- A software raster image processor (RIP) is included as a standard feature. It takes output data such as a PostScript file received from a program, performs raster image processing on the computer, and outputs the data to the machine.
- Installing a media take-up system (available separately) enables automatic take-up of the media during printing. This enables unattended operation at night and lengthy printing to be accomplished efficiently.

About the Notation Used in This Manual

This document is the user's manual for both the VP-540 and the VP-300. This document uses the following notation to distinguish between the two models where necessary.

VP-540	—	54-inch model
VP-300	—	30-inch model

Also, most of the figures in this document depict the VP-540.

1-2 Part Names and Functions

Printer Unit

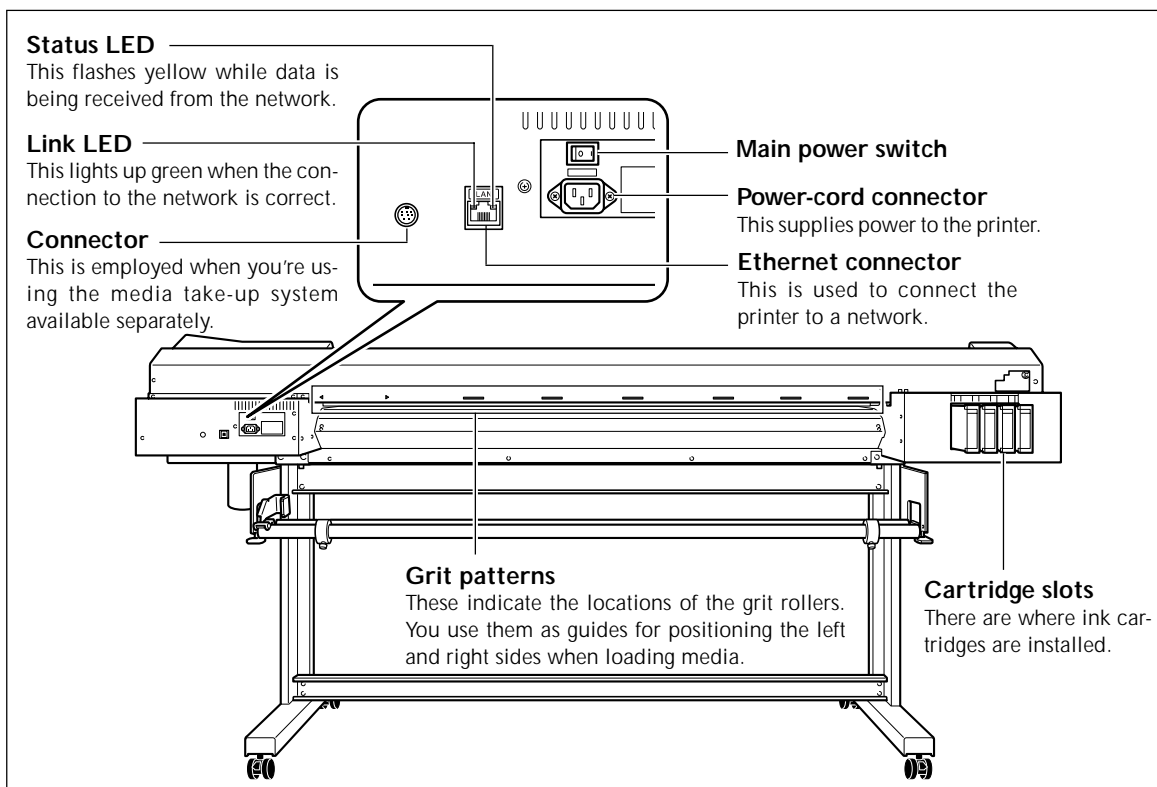
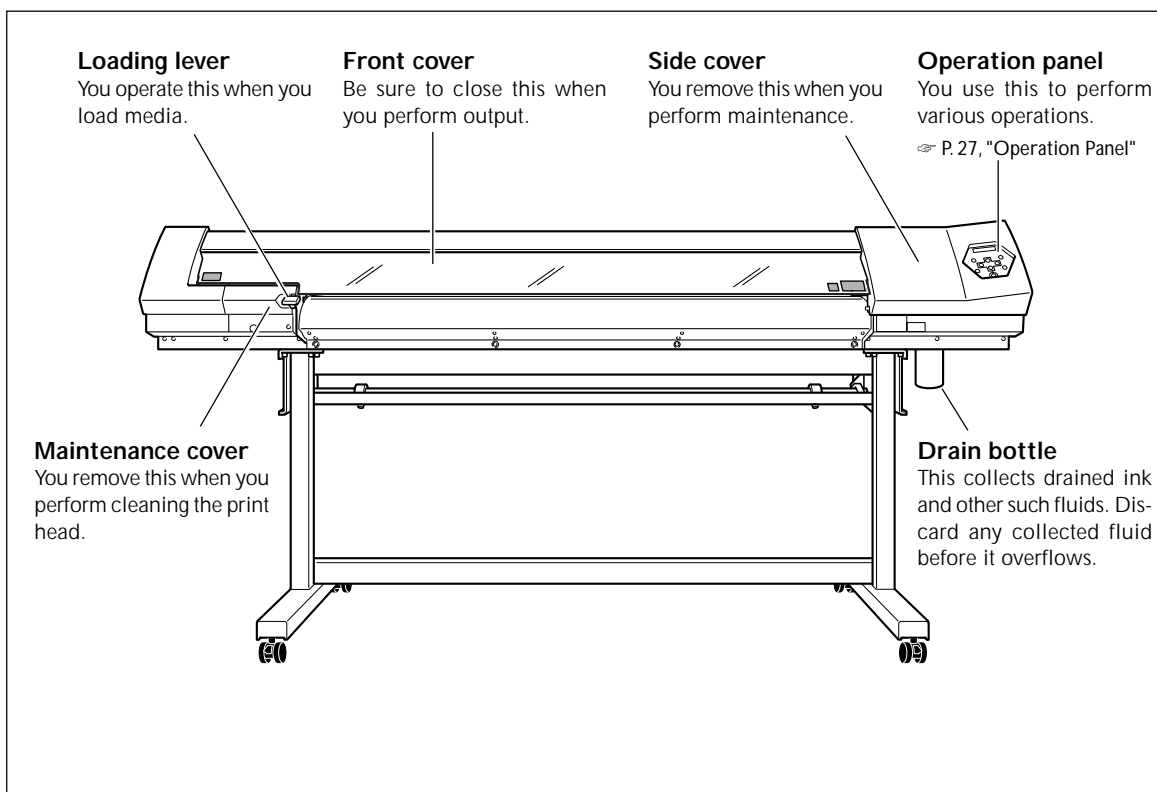

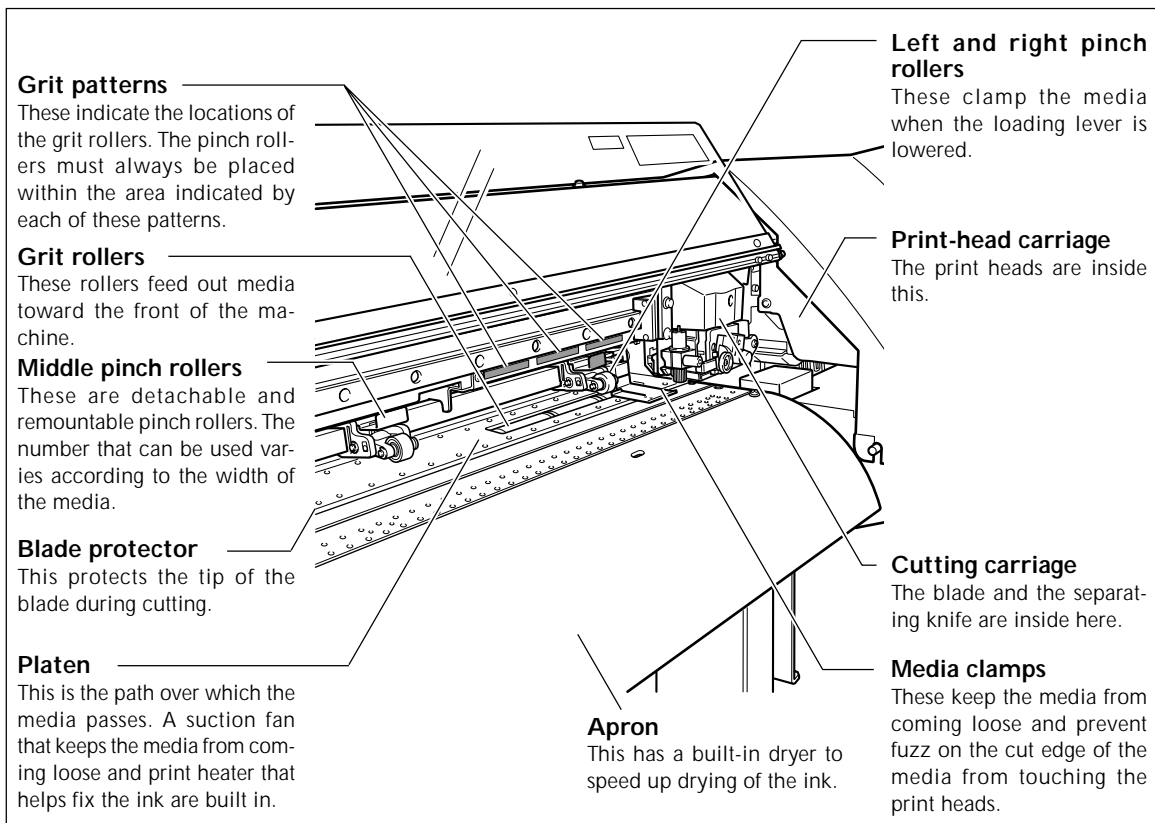

Operation Panel

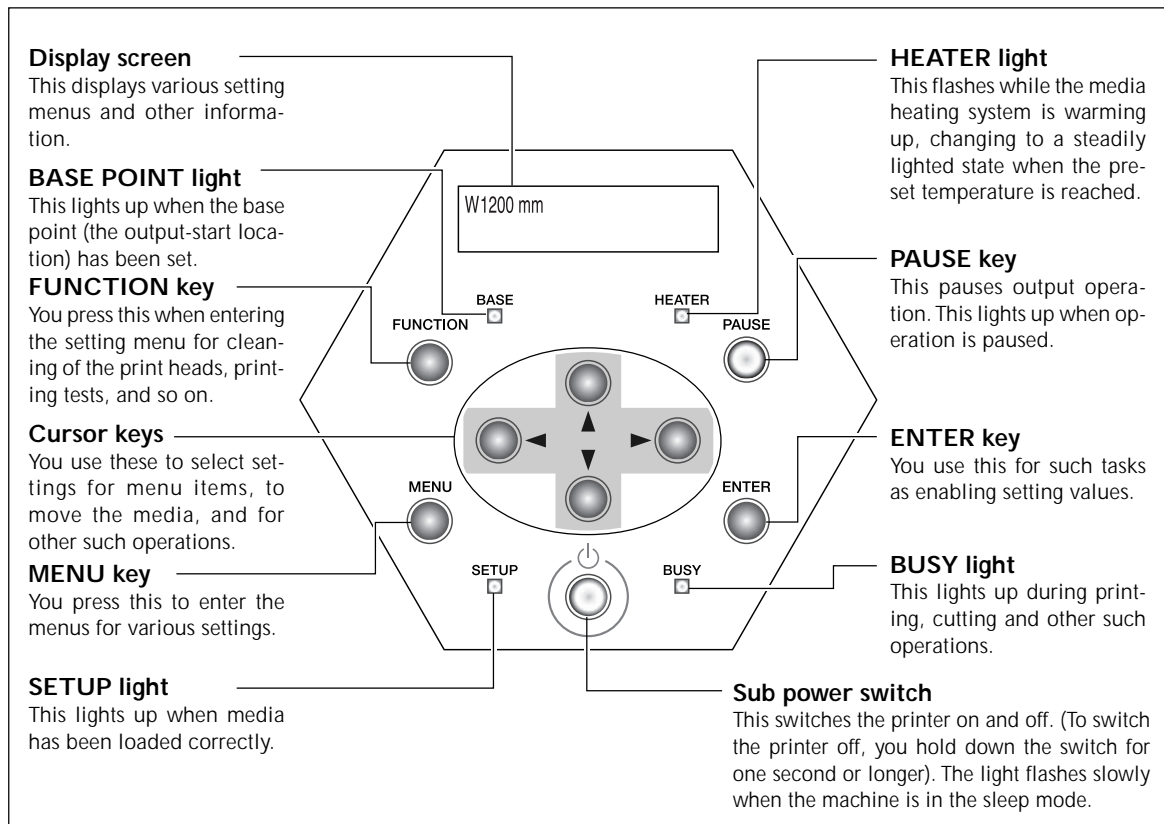

Panel Notation

In this document, the keys and lights on the control panel are indicated by the following images.

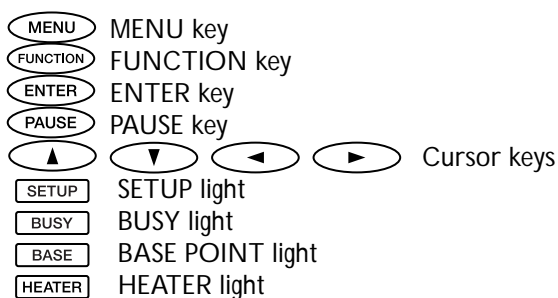

Chapter 2

Operation

2-1 Switching the Power On and Off

Switching the Power On and Off

This machine has a main power switch and a sub power switch. When using the machine, you switch both on in this sequence: first the main power, then the sub power.

Whenever output is finished, switch off the sub power. Also, raise the loading lever.

Leave the main power switch ① on at all times, never switching it off.

⚠ WARNING When output is not being performed, remove any loaded media or switch off the sub power.

The continued application of heat at a single location may cause the release of toxic gases from the media or pose a fire hazard.

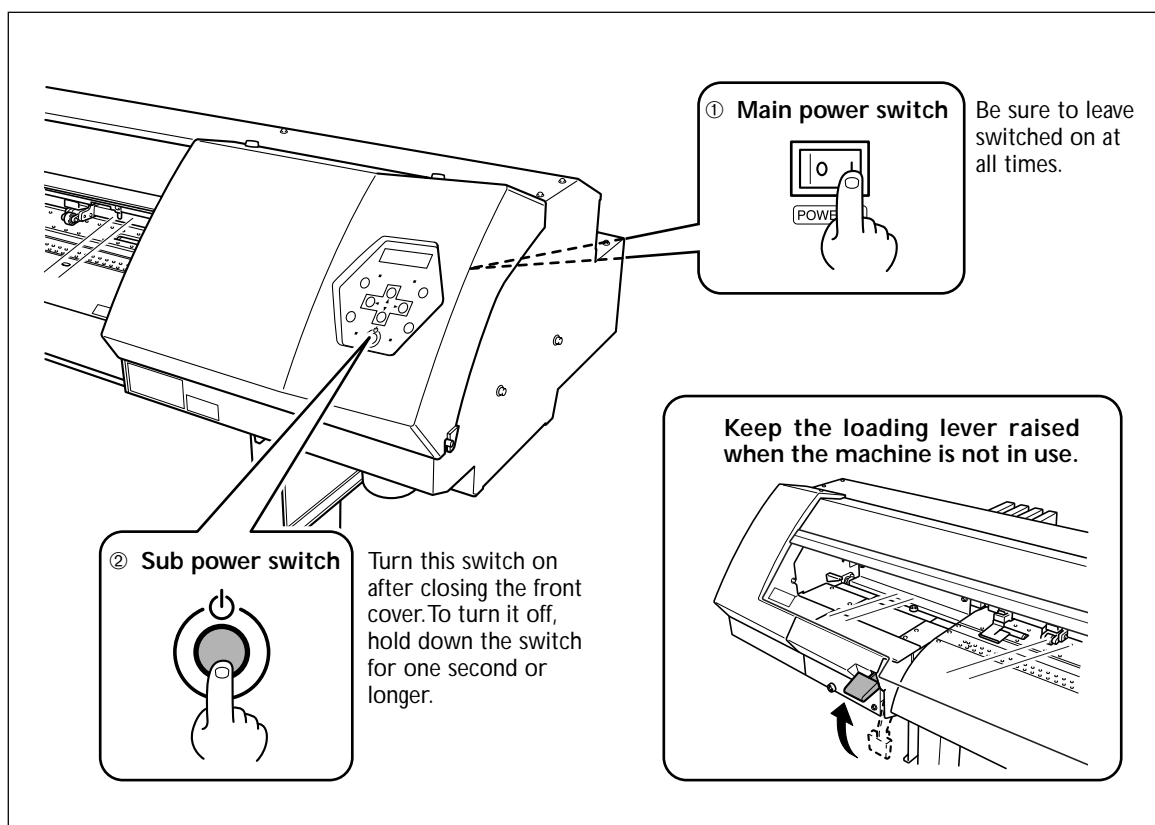

Important Note on Switching Off the Power

Never switch off the main power or unplug the power cord suddenly while operation is in progress. Doing so may damage the print heads. Be sure to first switch off the sub power.

If the main power is accidentally switched off, immediately turn the power back on.

The Power-saving Feature

This machine is provided with a power-saving feature that switches to a low-power "sleep mode" when a fixed interval passes with no operation. The factory default for the time after which the machine switches to the sleep mode is 30 minutes.

You can change the setting for the time of the shift to the sleep mode. You can also switch off the power-saving feature.

☞ P. 85, "Setting the Interval until Activation of the Sleep Mode," p. 85, "Deactivating the Sleep Mode"

When the machine is in the sleep mode, the sub power switch flashes slowly and the media heating system stops. Using the operation panel or performing operations such as sending output data from the computer (when media is loaded) restores the machine to its normal mode.

To reduce power consumption and prevent problems such as overheating, we recommend leaving the power-saving feature on and setting the activation time for the sleep mode to 30 minutes or less.

2-2 Loading and Cutting Off Media

Loading Media

Media may be of one of two types: media wound onto a paper tube (called "roll media") and media not rolled in this way (called "sheet media"). This section explains how to load media, using roll media as an example. For information on how to load sheet media, refer to the page indicated below.

☞ P. 82 "How to Load Sheet Media"

- ⚠ CAUTION** Load roll media correctly. Otherwise the media may fall and cause injury.
- ⚠ CAUTION** Roll media weighs about 30 kg (66 lb.). To avoid injury, handle with care.
- ⚠ CAUTION** Never load media that weighs more than 30 kg (66 lb.) (or, for the 30-inch model, more than 20 kg (44 lb.)). The machine may fail to withstand the weight and tip over or cause the media to fall.

1. Pass the media through the machine and position it correctly on the left and right.

- 1** Open the front cover.
Move the media clamps to the sides.

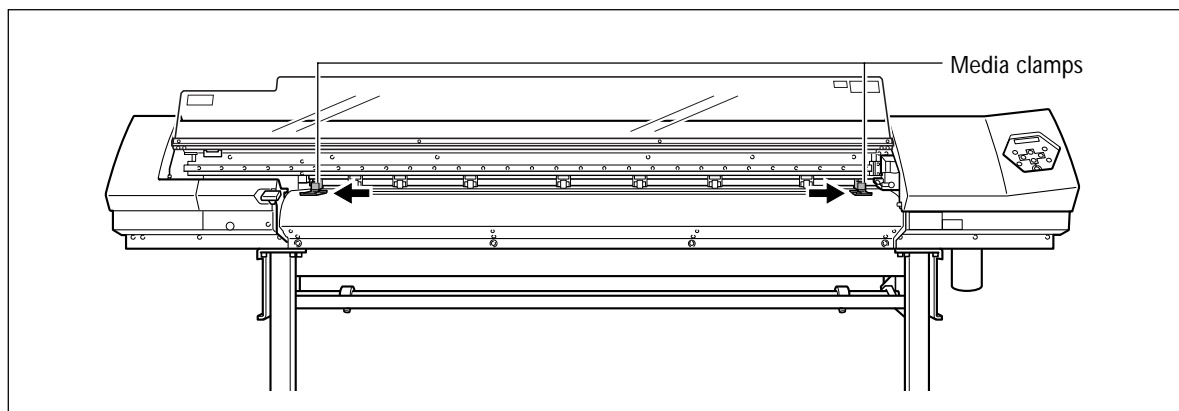

- 2** Attach the media flanges to the roll media.
If the inner diameter of the roll-media core measures 3 inches, fit the media flanges onto the core, then turn each knob clockwise all the way to keep the media flanges from falling out.

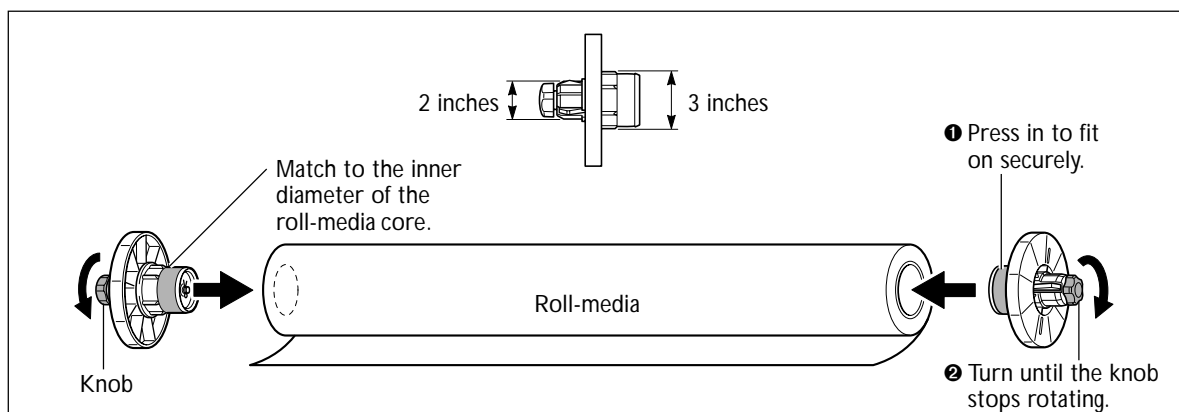

3 Place the roll media on the shafts and position its left and right edges to match the grit patterns.

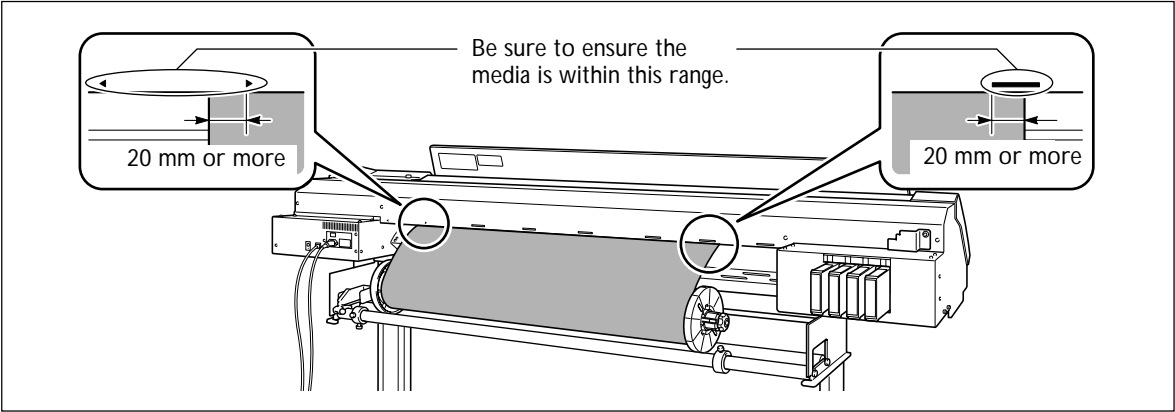

4 Secure the stoppers in place in alignment with the width of the media. Make sure the media flanges are straight. Correct media feed is impossible if either of the media flanges is at an angle.

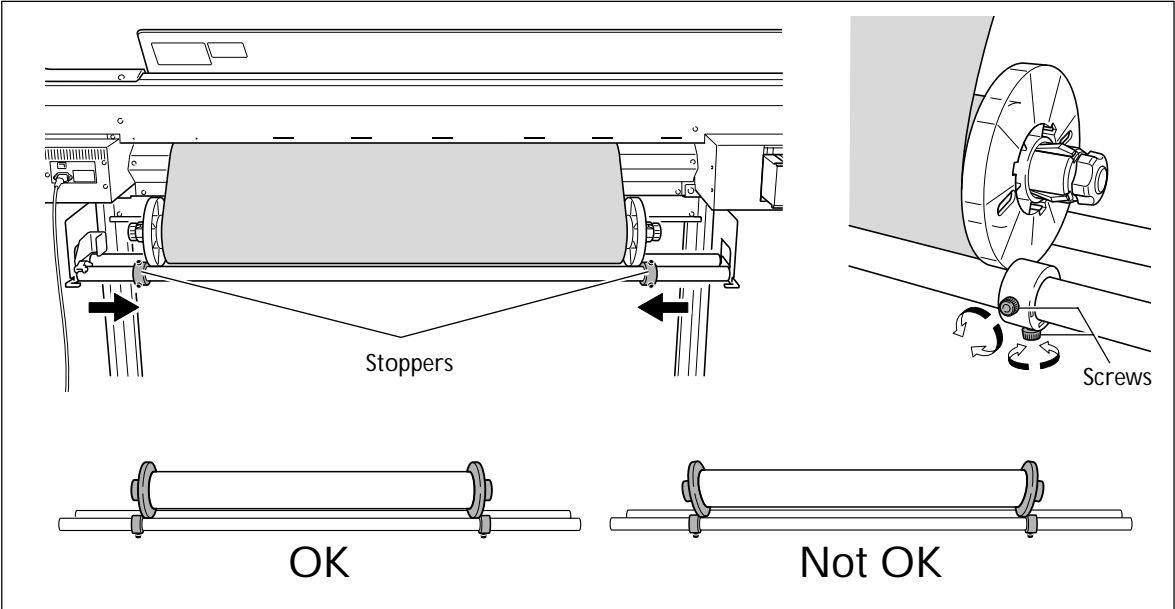

5 Pass the leading edge of the media between the grit rollers and the pinch rollers, and feed it out as far as the platen.

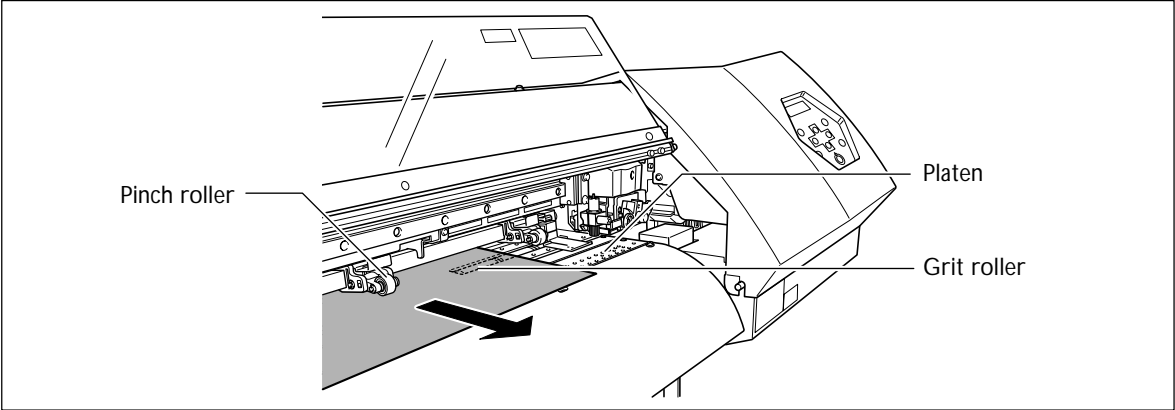

2-2 Loading and Cutting Off Media

- ⑥ Make sure both edges of the media are above the grit rollers, then place pinch rollers over all grit rollers covered by the media.

Placing the pinch rollers inside each of the grit patterns ensures that they are positioned above the grit rollers. Be sure to place the left and right pinch rollers (affixed with blue stickers) at the edges of the media. Arrange the middle pinch rollers above all the grit rollers that lie between the left and right pinch rollers.

Be sure to remove any extra middle pinch rollers, leaving only the same number of middle pinch rollers as the number of grit rollers.

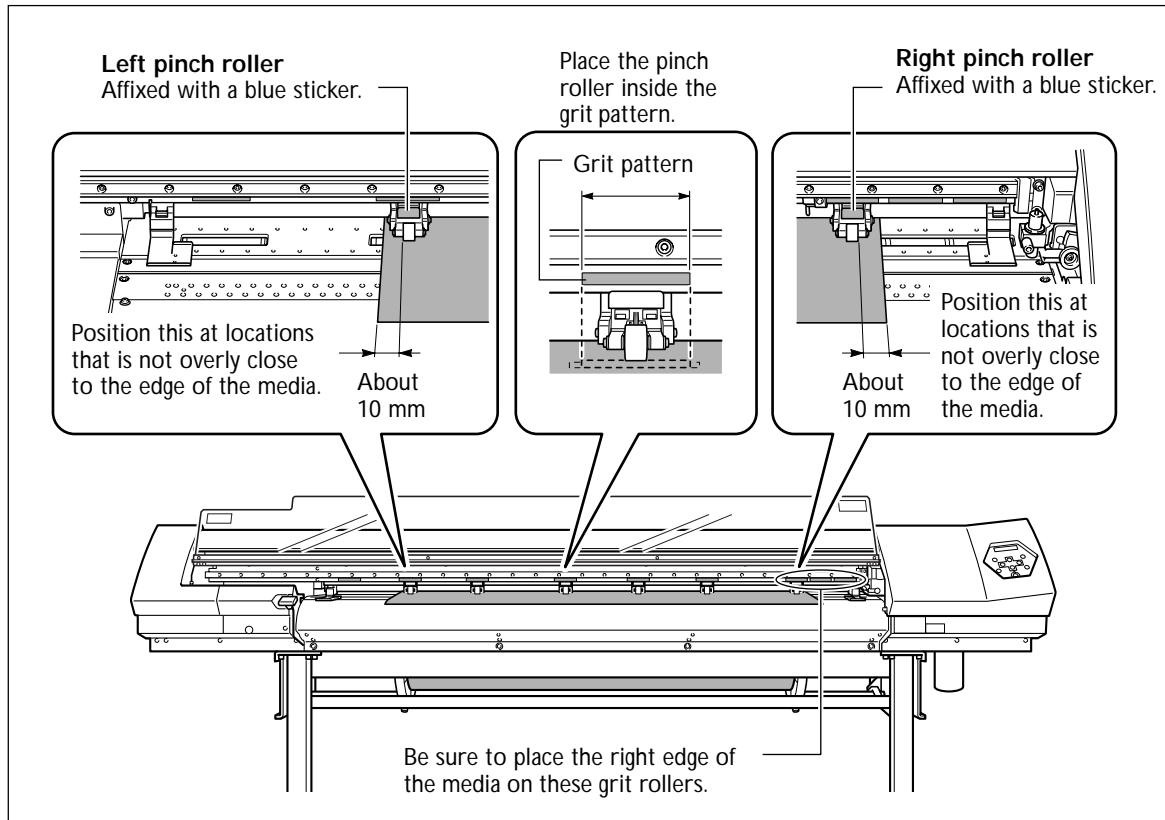

Attaching and Detaching Middle Pinch Rollers

Perform attachment or detachment at the location shown in the figure.

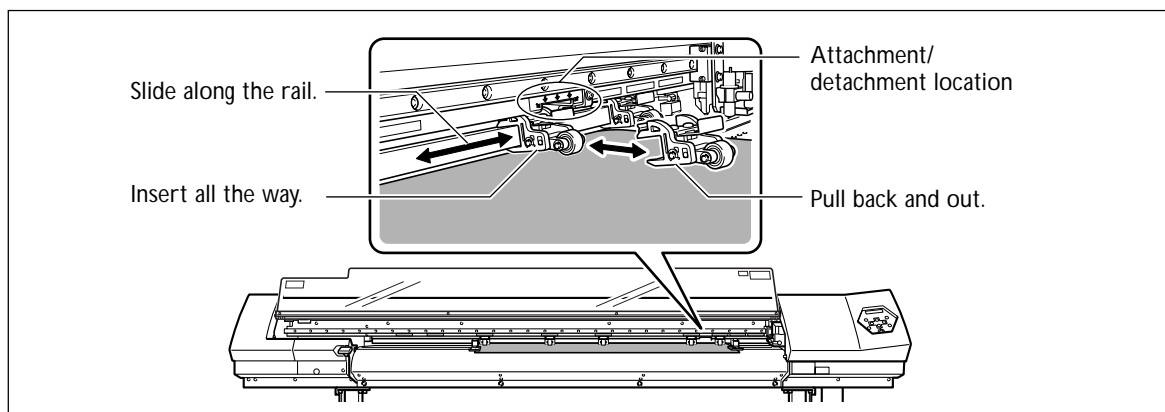

2. Secure the media in place so that it is without slack.

- 1 Hold the media at the center and pull it out, being sure to keep it straight. Make sure all areas of the media are taut.

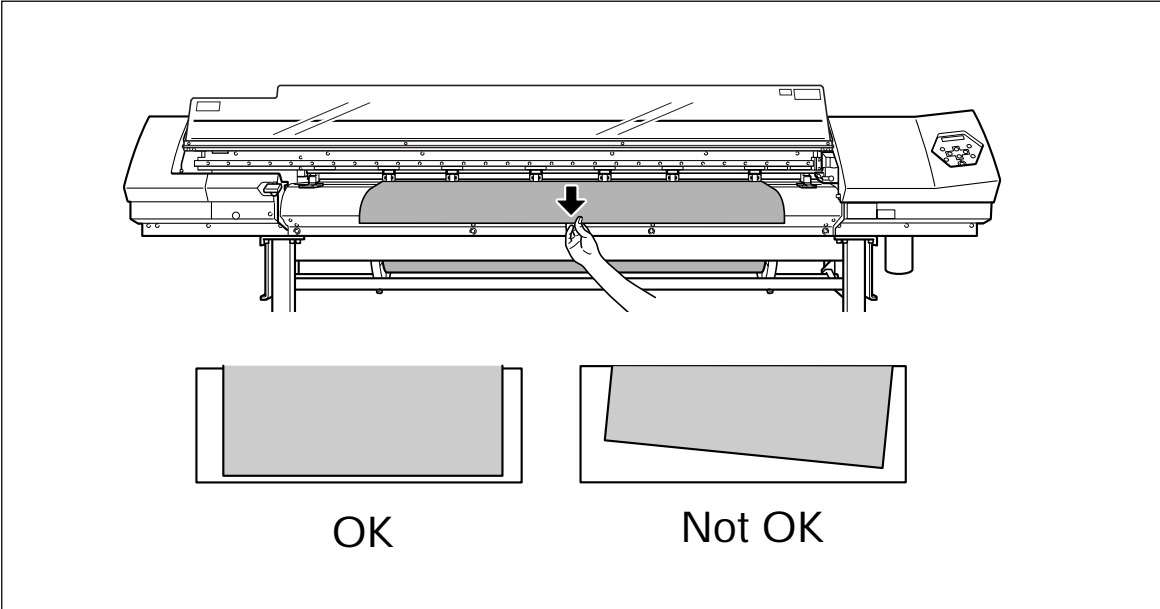

- 2 Lower the loading lever to hold the media in place. **SETUP** starts to flash, and then the screen shown in the figure appears.

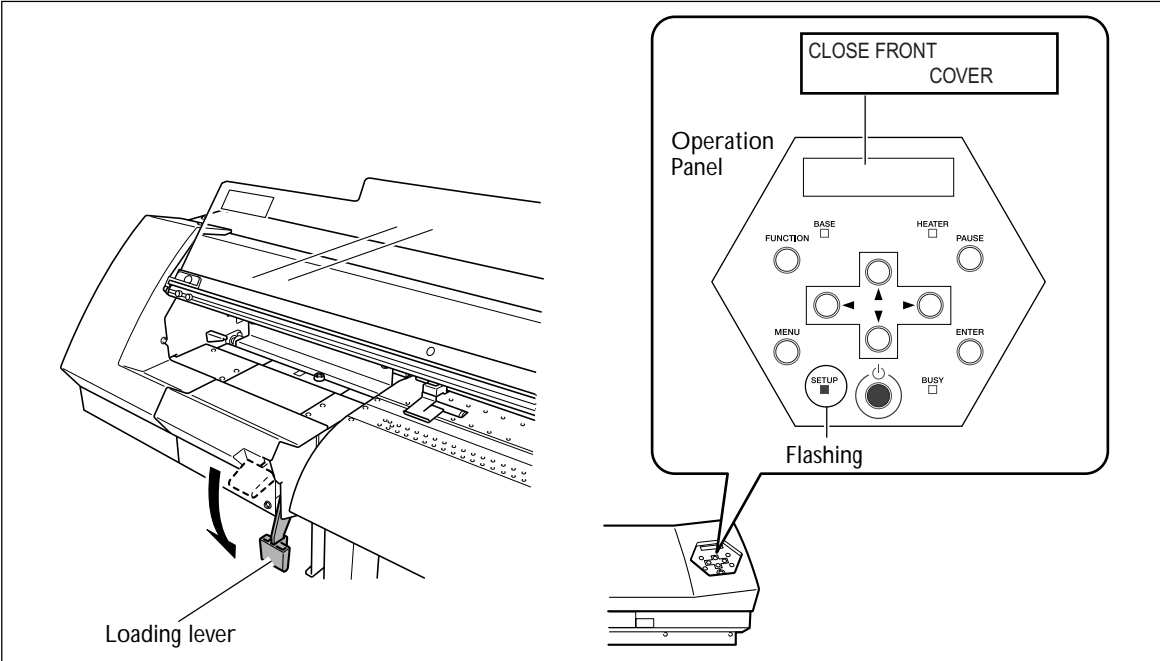

3. Clamp the edges of the media with the media clamp.

① Move the media clamps as shown in the figure below.

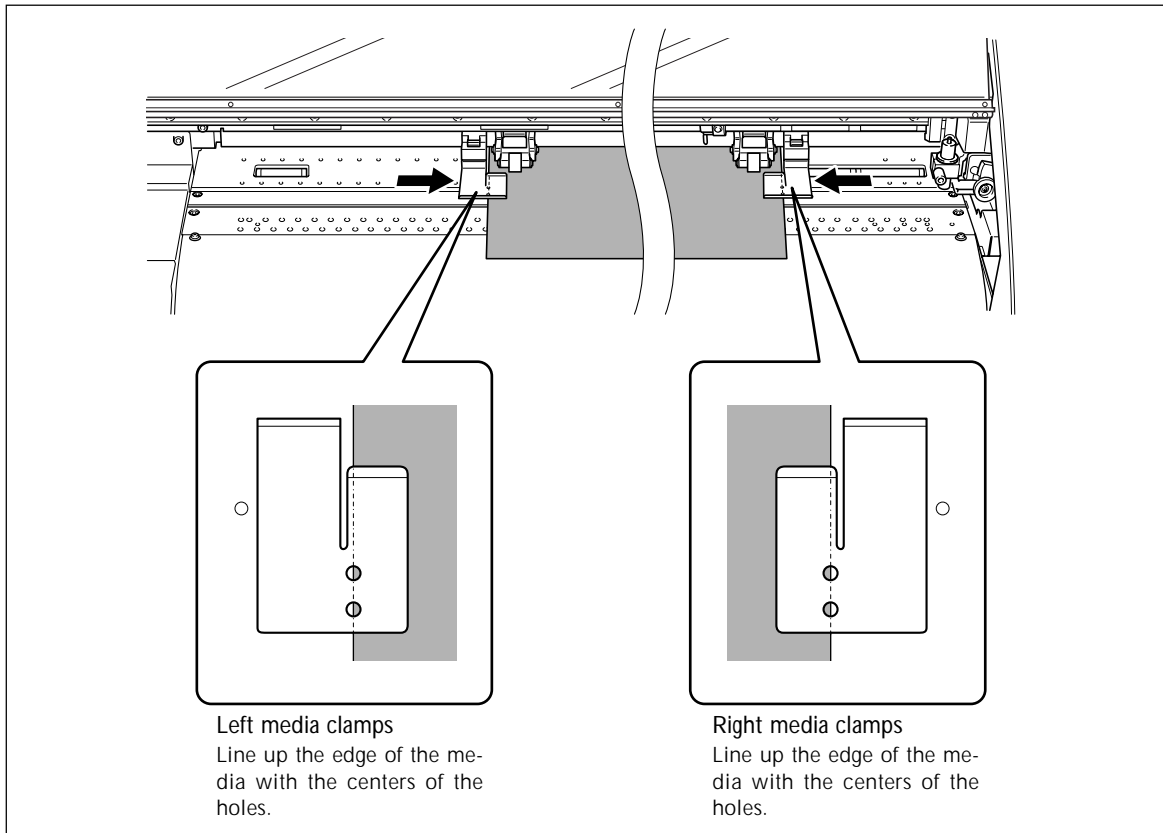

②

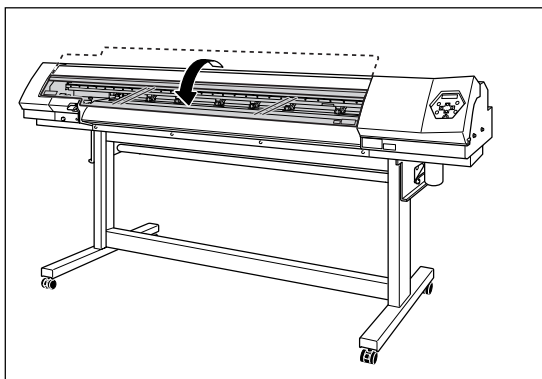

Close the front cover.

W1200mm

When initialization ends, **SETUP** remains steadily lighted, and the printable width is displayed.

This completes loading of the media.

Important Note When Using the Media Clamps

- Set the media clamps at the correct locations. If they are not set at the correct locations, the media may catch, preventing successful printing.
- As printing proceeds, the media may move to the left or right and touch or come loose from the media clamps. After about 1 m (3 ft.) of media has been fed, check the positioning of the media clamps. If the media looks like it may come loose from the media clamps, adjust the positioning of the media clamps.
- Moving a media clamp to the right edge of the platen as shown in the figure below may cause it to be hidden by the cutting carriage and make it impossible to detach the media clamp without further action. If this happens, first load the media, then lower the loading lever. After **SETUP** lights up, use  to move the cutting carriage to a location where it doesn't obstruct the media clamp, then detach or move the media clamp.

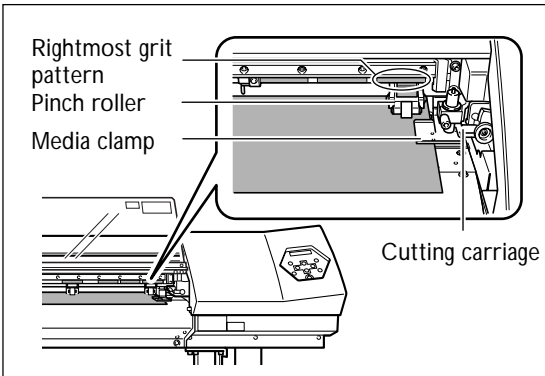

Position the pinch rollers over the grit rollers.

If the message shown in the figure appears when you close the front cover, check the positions of the pinch rollers and the middle pinch rollers. These must be placed over the grit rollers. Also, if the number of middle pinch rollers installed is greater than the number of grit rollers used, then detach the extra middle pinch rollers.

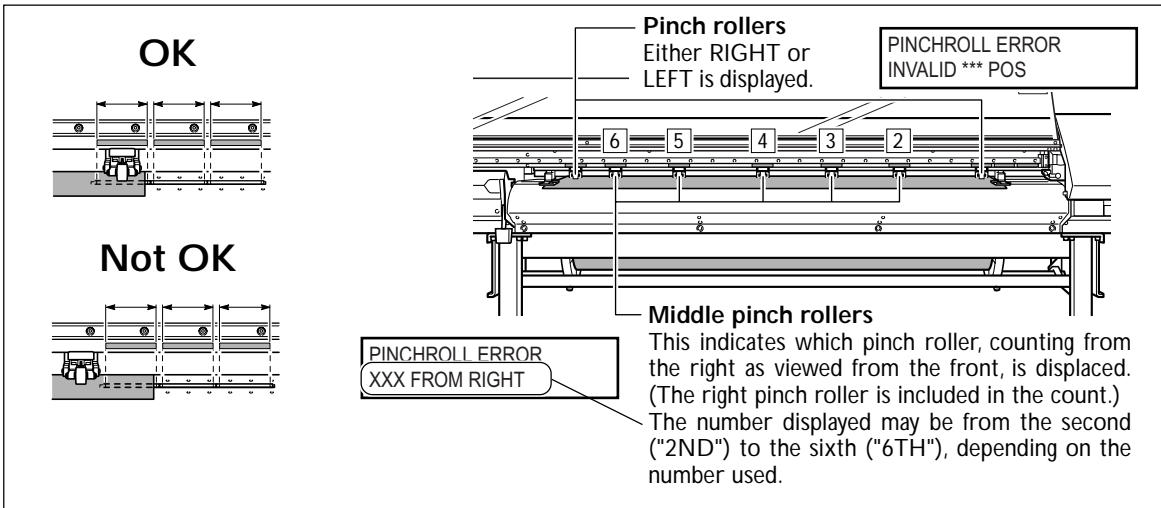

Remove when not using roll media.

If roll media is allowed to stand unused in a loaded state for an extended period, the media may sag. This can cause poor printing quality and motor errors, so be sure to remove and store such media when not in use.

Cutting Off the Media

Procedure

- 1 Close the front cover.
Make sure **SETUP** lights up.

- 2 

Press **FUNCTION**.
Press **▼** several times.

- 3 Press **ENTER**.

The media is cut off.

The cutoff location on the media is as shown in the figure below.

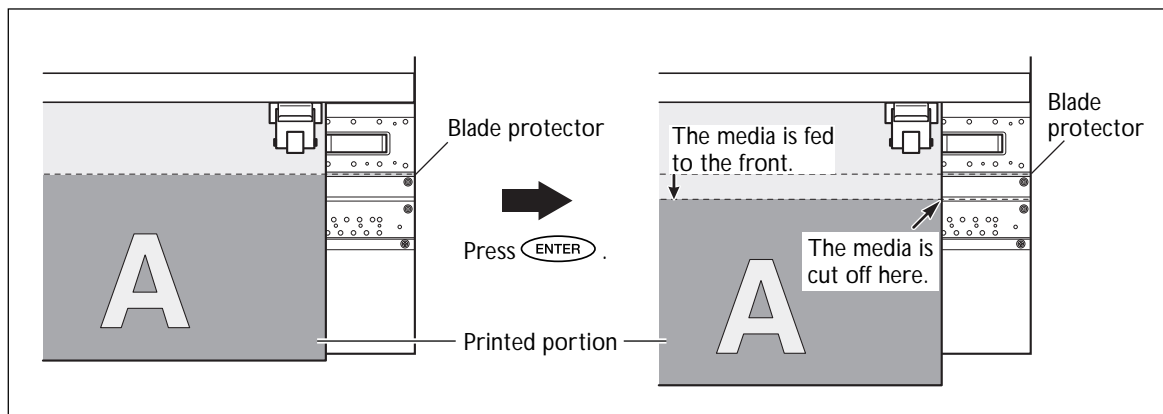

You can make the setting in the software RIP for automatic media cutoff after printing or cutting has finished. For information on how to make the setting, refer to the documentation for the software RIP you're using.

Important Notes on Using the Long Media Clamps

When you're using the long media clamps, be sure to set the [MEDIA CLAMP] menu item to [LONG] to disable media cutoff. Performing cutting the media when the long media clamps are installed causes interference with the separating knife, which may result in malfunction or damage to the machine.

If you want to separate the media after printing has finished, be sure to first detach the long media clamps, then set the [MEDIA CLAMP] menu item to a setting other than [LONG].

☞ P.81, "Printing Media That Warps Easily"

Give Attention to Media Composition

- For some types of media, cutoff is not possible.
- Some types of media may remain on the platen after cutoff. If the media remains on the platen, remove it by hand.
- When you cut off media while using the short media clamps, then depending on the media, it may come loose from the media clamps. After you cut off the media, check to make sure that the media has not come loose from the media clamps.

Before you're performing cutoff, never use **▲ to pull the media back.**

Unless the end of the media has been pulled out to a location to the front of the platen, cutoff may not be performed smoothly.

2-3 Settings for the Media Heating System

What Is the Media Heating System?

This machine is equipped with a media heating system that warms the media. You use this mainly to improve ink adhesion and dry the ink. You can adjust the temperature settings to match the type of media and the printing speed.

Print heater

This heater is used mainly to improve ink adhesion.

Dryer

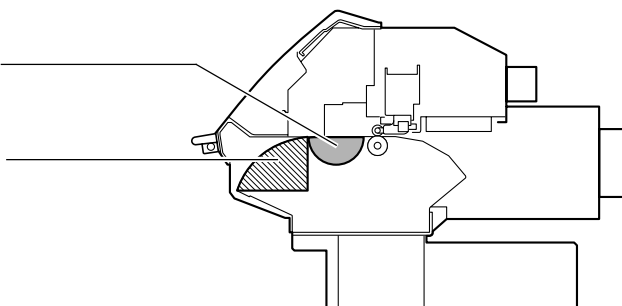

You use this to speed up drying of the ink.



- ⚠ WARNING** **Caution: high temperatures**
The platen and dryer become hot. Exercise caution to avoid fire or burns.
- ⚠ WARNING** **Remove any loaded media or switch off the sub power when printing is not being performed.**
The continued application of heat at a single location may cause fire or produce toxic gases.
- ⚠ WARNING** **Never use media that cannot withstand the heat.**
Doing so may result in fire or the release of toxic gases, or may degrade the media.
- ⚠ WARNING** **Never use the platen or dryer for any purpose for which they are not intended, such as to dry clothing.**
Doing so may cause overheating, resulting in fire or accident.

Making the Temperature Setting for the Media Heating System

Procedure

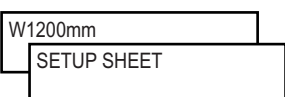
- 1**  Press **FUNCTION**.
Press **▼** several times.
- 2** 
Present dryer temperature
Press **▶**.
Use **▲** **▼** to select [PRINT] (print heater) or [DRYER] (dryer).
- 3**  Press **▶**.
Use **▲** **▼** to make the setting.
Press **ENTER** to enable the setting.
- 4**  Press **FUNCTION** to go back to the original screen.

By default, simply switching on the power does not make the media heating system warm up to the preset temperature. When media is loaded correctly and **SETUP** comes on, warm-up to the preset temperature occurs.

General Guide for the Preset Temperatures

The optimal temperature for the media heating system varies according to such factors as the type of media and differences in the print mode. Use the following as a general guide and adjust accordingly.

General Guide for Adjustment

Print heater

You use this mainly to improve ink adhesion and inhibit smudging.

If the ink forms lumps or smudges, raise the temperature. Note, however, that a temperature that is too high may degrade the media or cause it to wrinkle.

Dryer

When ink drying is poor, raise the temperature. Note, however, that a temperature that is too high may degrade the media or cause it to wrinkle.

The relationship between the print mode and temperature

If smudging or poor drying occur even after raising the temperature, try using a print mode offering higher image quality. Conversely, when you want to use a faster print mode, raise the temperature.

Amount of ink

When you change the amount of ink using the settings for your software RIP, adjusting this may yield better results. If problems such as smudging persist even after raising the temperature, try reducing the amount of ink.

➤ When suggested settings for temperature, print mode, and other values are given, use the suggested settings.

Use at an ambient temperature of 20 to 32°C (68 to 90°F).

If the machine is used at an ambient temperature lower than 20°C (68°F), then depending on the type or width of the media, wrinkling or temperature-caused unevenness may occur. If this happens, try lowering the temperature of the media heating system by about 2°C. To obtain stable printing results, however, the machine should be used at an ambient temperature of 20 to 32°C (68 to 90°F).

2-4 Starting Output

Getting Ready to Receive Data from a Computer

When you have finished loading media and making the temperature settings for the media heating system, then follow the steps below. This procedure enables the machine to receive data from the computer and perform output. When printing data that includes cutting paths is received, you can also carry out cutting immediately after performing printing.

Note, however, that when you want to perform only cutting, operation that differs from the following procedure is required.

☞ P. 45, "To Perform Cutting"

⚠ CAUTION Never touch the print heads while output is in progress.
The print heads move at high speed. Contact may cause injury.

Procedure

- 1 Close the front cover.
- 2 Make sure **SETUP** stays steadily lit.
If the light does not come on, lower the loading lever.
- 3 Wait until **HEATER** stops flashing and stays steadily lit.
- 4 Make sure the top menu is displayed.
If the top menu is not displayed, press **MENU**, then press **◀**.

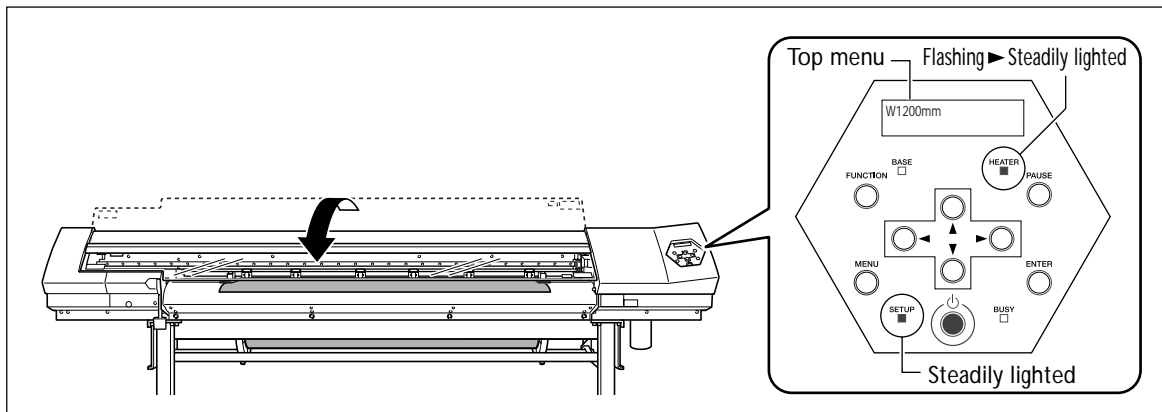

Output Is Not Possible in These Situations

- The machine does not run when the front cover is open. Also, never open it when printing is in progress. Doing so interrupts printing.
- Data from the computer is not accepted when **SETUP** is dark.
- Printing does not start until **HEATER** lights up.
- Data from the computer is not accepted when you are not at the top menu.

Points Which Must Be Observed

- Be sure to set the media clamps during printing. Otherwise the edges of the media may warp and catch on the print heads.
- During output, never touch the media that's already been discharged. Doing so may obstruct media feed or cause the media to rub against the heads, which may result in a paper jam or damage to the heads.

Printing Tests and Cleaning

Before you carry out actual printing, we recommend performing a printing test to ensure no dot drop-out occurs. If dot drop-out occurs, perform cleaning.

How to Perform a Printing Test



Press **FUNCTION**.

Press **▼**.



Press **▶**.

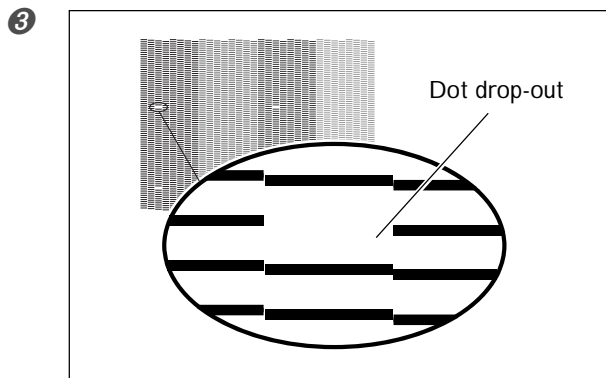

Press **ENTER**.

A test pattern is printed.

You can freely set the location for printing the test pattern.

☞ P. 69, "Setting the Output-start Location"

How to Perform Cleaning



Press **FUNCTION**.

Press **▼**.

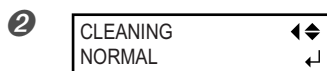

Press **▶**.

Press **▼**.

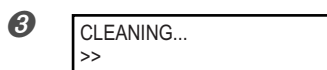

Press **ENTER**.

Cleaning starts.

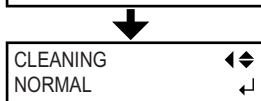

When it finishes, the screen shown in the figure appears again.



Press **FUNCTION** to go back to the original screen.

5 Perform a printing test again to make sure the dot drop-out has been corrected.

If the problem persists, try performing cleaning a second time.







If the problem doesn't go away even after performing cleaning two or three times, then try cleaning using a different method.

☞ P. 53, "When Head Cleaning Is Not Effective"

2-5 If Ink Runs Out

Checking for Remaining Ink

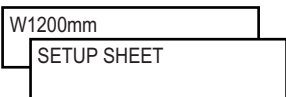
Procedure

-  Press .
Press  several times.
-  Press .
-  Press  to go back to the original screen.

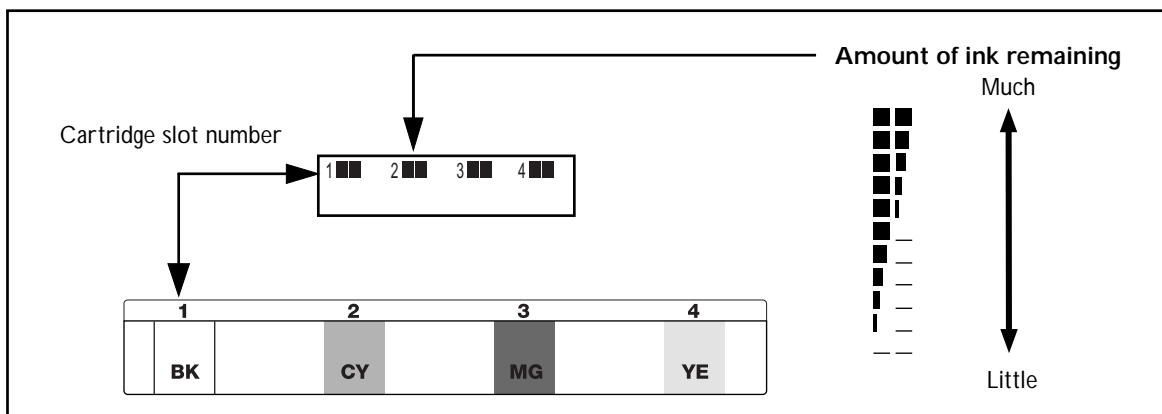

The display shows an approximate guide to the amount of remaining ink, which may differ somewhat from the actual amount remaining.

If Ink Runs Out

When ink runs out, a warning beep sounds and printing pauses (unless the default settings have been changed). Pull out the empty cartridge and insert a new one. Printing resumes.

Procedure

1



The slot number for the empty cartridge flashes.

2

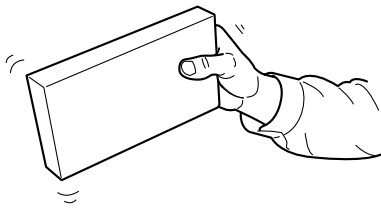

Gently shake the new cartridge.

3 Pull out the empty cartridge and immediately insert the new one.

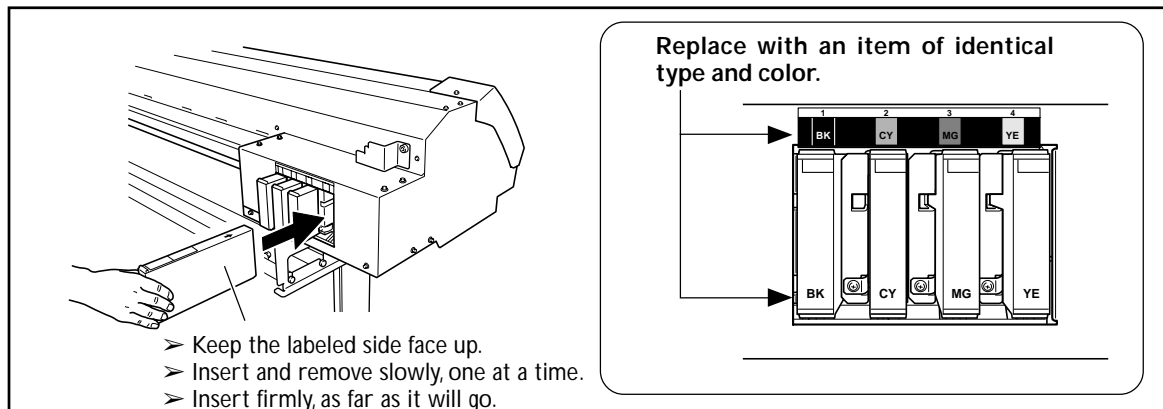

Important Notes on Replacing Cartridges

- Be sure to replace with an item of identical type. Never mix items of different types.
- Never allow the machine to stand with an ink cartridge removed. The print heads may become clogged.
- Never insert or remove a partially used ink cartridge.
- Never remove an ink cartridge suddenly while the printer is in operation.
- When printing is paused, the coloring at the seam may be altered when printing resumes. Before you perform lengthy printing, check the amount of ink remaining in the ink cartridges.

⚠ WARNING If you're using a model that uses ECO-SOL MAX ink, never store ink, cleaning fluid, or discharged fluid in any of the following locations.

- Any location exposed to open flame
- Any location where high temperature may occur
- Near bleach or any other such oxidizing agent or explosive material
- Any location within the reach of children

Fire may be a danger. Accidental ingestion by children may pose a health hazard.

2-6 Performing Cutting

To Perform Cutting

To perform cutting, carry out the procedure described below.

- Move the media clamps to locations where they don't clamp the media. Alternatively, remove the media clamps.

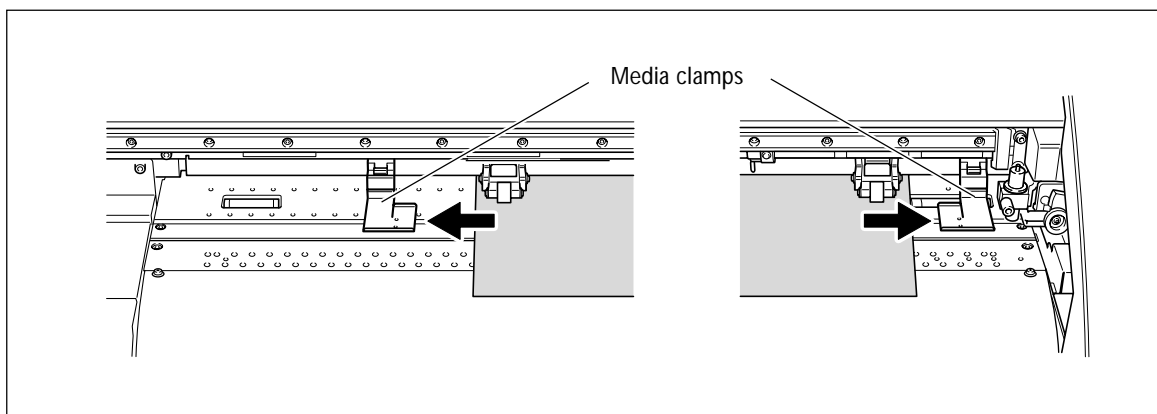

- When you're performing cutting only, then if you're cutting roll media, allow the media to hang down from the rear of the machine.

If cutting is started without doing this first, a motor error may occur or the roll may fall because the media is pulled with excessive force.

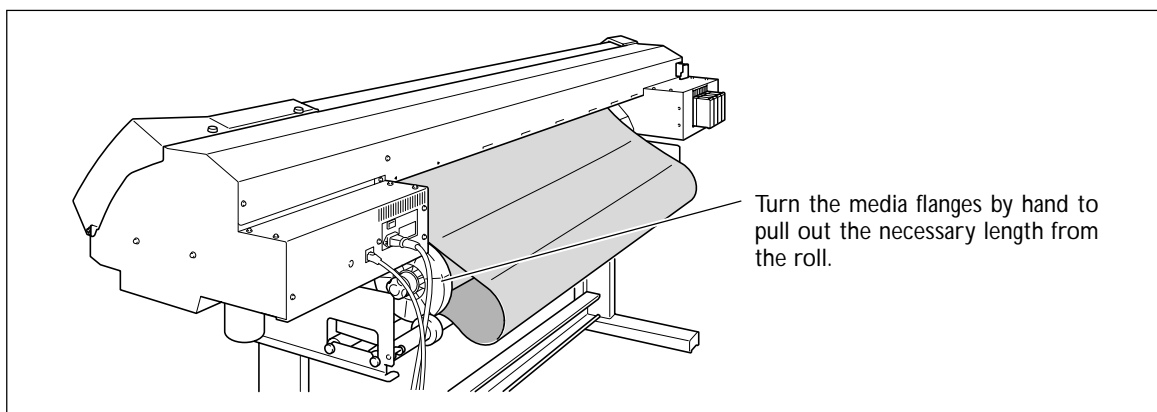

Important Notes on Cutting

- Never use the media clamps. You can also detach them when not in use.
 - ☞ P. 81, "Printing Media That Warps Easily"
- When you're performing printing followed immediately by cutting, then before you start cutting, allow the ink to dry sufficiently. Use your software RIP to make the setting for the drying time. For information on how to make the setting, refer to the documentation for the software RIP you're using. The drying time varies according to the media.





Hints and Tips for Cutting

- Setting the [PREFEED] menu item to "ENABLE" makes the machine automatically feed out media and take it up again before cutting. This makes it unnecessary to run out media to the rear of the machine before the operation.
 - ☞ P. 91, "Preventing Pulling of the Media with Undue Force When Performing Cutting Only"
- When you're performing cutting, switching off the print heater and dryer and allowing the temperature to cool before performing cutting can yield results that are more stable.
 - ☞ P. 87, "Switching Off the Print Heater and Dryer"
- The end of the cap for the blade holder may scrape or damage the printed surface. If this happens, increase the amount of blade extension.
 - ☞ P. 90, "Accurately Adjusting the Cutting-in Amount"

Performing a Cutting Test

For high-quality cutting, then before you perform actual cutting, we recommend carrying out a cutting test to check the cutting quality for the media.

Performing a Cutting Test

- 1 Use     to move the cutting carriage to the location where you want to carry out the cutting test.

You can freely set the location for the cutting test.

- 2  Press  .
Press  several times.

- 3  Press  .

- 4  Close the front cover.
Press  .
The test pattern is cut.



- 5 Peel off the cut shapes to verify the cutting quality.

If two shapes peel off together, make the setting for blade force.

☞ P. 47, "Making the Setting for Blade Force"

Making the Setting for Blade Force

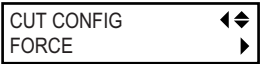
Procedure

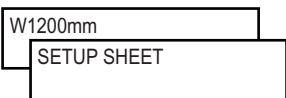
- ①  Press **FUNCTION**.
Press **▼** several times.
- ②  Press **▶**.
Press **▼** several times.
- ③  Press **▶**.
Use **▲** **▼** to enter the value.
- ④  Press **ENTER**.
This completes the settings.
- ⑤  Press **FUNCTION** to go back to the original screen.

At the [CUT CONFIG] menu, you can also make settings for other cutting conditions in addition to the blade force. Refer to the following pages.

☞ P. 89, "Fine-tuning the Cutting Conditions"

Chapter 3

Maintenance and Adjustment

3-1 Daily Care and Maintenance

Disposing of Discharged Ink

The drain bottle collects discharged fluid. Dispose of collected material before the bottle becomes full. The message shown in the figure appears when a certain amount of discharged fluid has collected in the bottle. Follow the procedure below to discard the discharged fluid.

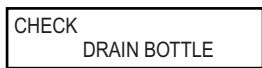

Resetting the discharged-fluid counter after disposal makes the message shown in the figure disappear.

Press **ENTER**.

1. Choose the "DRAIN BOTTLE" menu item.



Press **MENU**.
Press **▼** several times.



Press **▶**.
Press **▲**.



Press **▶**.
Press **▲**.





Press **ENTER**.
Preparations are complete when this screen appears.

2. Empty the bottle by discarding the discharged fluid.

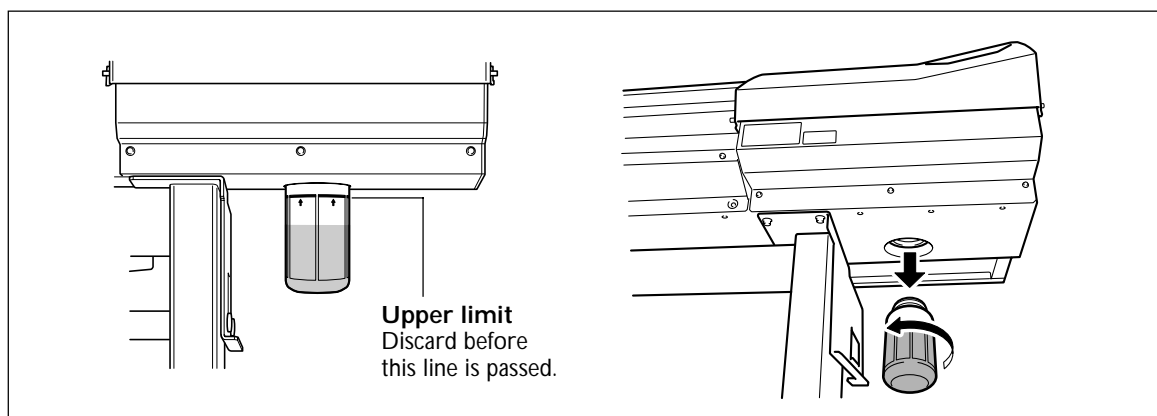
⚠ CAUTION Before you detach the drain bottle, be sure to wait for the screen to display "EMPTY DRAIN BOTTLE."
Failing to follow this procedure may cause discharged fluid to flow out of the tube and spill, soiling your hands or the floor.

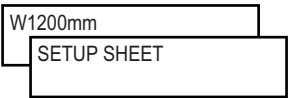

3. Attach the emptied bottle and reset the discharged-fluid count.

- ①  Press **ENTER**.
The screen shown in the figure appears.
- ②  Press **ENTER** a second time.
- ③  Press **MENU** to go back to the original screen.

⚠ WARNING Never place discharged fluid near open flame.
Doing so may cause fire.

⚠ CAUTION To store discharged fluid temporarily, place it in the included drain bottle or in a durable sealed container such as a metal can or polyethylene tank, and cap tightly. Any spillage or vapor leakage may cause fire, odor, or physical distress.

Dispose of discharged fluid properly, in accordance with the laws in effect in your locale. Discharged fluid is flammable and contains toxic ingredients. Never attempt to incinerate discharged fluid or discard it with ordinary trash. Also, do not dispose of it in sewer systems, rivers, or streams. Doing so may have an adverse impact on the environment.

Cleaning

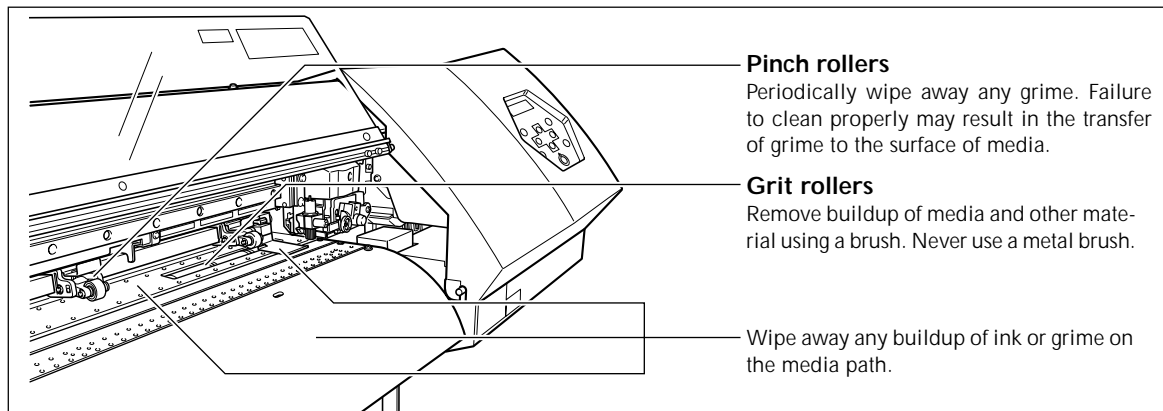

⚠ WARNING Never use gasoline, alcohol, thinner, or any other flammable material. Doing so may cause fire.

⚠ CAUTION Before attempting cleaning, switch off the sub power and wait until the platen and dryer cool (approximately 30 minutes). Sudden movement of the machine may cause injury, or hot components may cause burns.

- This machine is a precision device, and is sensitive to dust and dirt. Perform cleaning on a daily basis.
- Clean by wiping with a cloth moistened by neutral detergent diluted with water then wrung dry.
- Never attempt to oil or lubricate the machine.

Care and Maintenance of the Print Heads

Daily Care and Maintenance

Perform maintenance using the machine's head cleaning feature.

☞ P. 42, "Printing Tests and Cleaning," p. 53, "When Head Cleaning Is Not Effective"

Periodic Care and Maintenance

Periodic care is essential to ensuring optimal printing at all times. Based on your frequency of use, periodically clean the heads using a cleaning kit.

☞ P. 54, "Cleaning the Heads Using the Cleaning Kit"

Note: The print heads are components that wear out. Periodic replacement is required depending on the frequency of use. Purchase them from your authorized Roland DG Corp. dealer.

3-2 When Head Cleaning Is Not Effective

Performing More Powerful Cleaning

When the problems such as dot drop-out are not cleared up by the "normal cleaning," try the more forceful "medium cleaning" or the even more forceful "powerful cleaning." Note, however, that this consumes more ink than "normal cleaning," and too-frequent use may damage the print heads themselves. Avoid using it more than necessary.

1. Choose "medium cleaning" or "powerful cleaning."

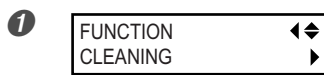

Press **FUNCTION**.
Press **▼** several times.

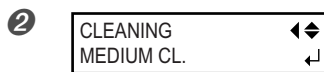

Press **▶**.
Use **▲** **▼** to choose "MEDIUM CL." or "POWERFUL CL."

2. Start cleaning.

1 Press **ENTER**.

If You Chose "MEDIUM CL."

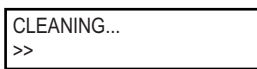

The screen shown in the figure appears, then cleaning starts.

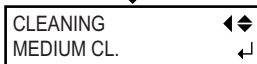

When it finishes, the screen shown in the figure appears. Go on to Step 4.

If You Chose "POWERFUL CL."



The screen shown in the figure appears. Go on to Step 2.

2 Check the drain bottle. If the amount of discharged fluid is near the upper-limit line, then remove the bottle, discard the collected fluid, and reattach the bottle.

☞ P. 50, "Disposing of Discharged Ink," step 2.

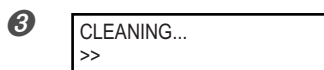

Press **ENTER**.
The screen shown in the figure appears, then cleaning starts.

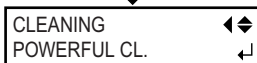

When it finishes, the screen shown in the figure appears again. Go on to Step 4.



Press **FUNCTION** to go back to the original screen.

When Powerful Cleaning Is Not Effective

If problems such as dot drop-out persist even after you have performed powerful cleaning several times, then use the cleaning kit to clean the heads. Such cleaning can be effective when carried out periodically, according to the frequency of use.

☞ P. 54, "Cleaning the Heads Using the Cleaning Kit"

3-3 Cleaning the Heads Using the Cleaning Kit

When the Cleaning Kit Becomes Necessary

Periodic Care and Maintenance

Use the cleaning kit to perform head-cleaning periodically, according to the frequency of use.

When Dot Drop-out or the Like Occur Frequently

When the machine's head-cleaning feature does not correct the problem, clean the heads using the cleaning kit.

- If you use up the cleaning kit, purchase a new one from your authorized Roland DG Corp. dealer.
- The print heads are components that wear out. Periodic replacement is required, with the frequency of replacement depending on use. Purchase them from your authorized Roland DG Corp. dealer.

How to Perform Cleaning

Important Notes on This Procedure

- To prevent the heads from drying out, finish this procedure in 30 minutes or less.
- A warning beep sounds after 30 minutes. At this time, stop work, and follow the procedure in step 4. on page 57 to attach the side cover and the maintenance cover, then close the front cover. Press **ENTER** to quit the manual-cleaning mode. After that, restart the procedure from the beginning.
- Never use any implement other than the included cleaning stick. Cotton swabs or other lint-producing items may damage the heads.
- Never touch the nozzle surface of the heads.
- Stroke the sponges very gently, applying as little pressure as possible. Never rub, scrape, or crush them.

⚠ CAUTION Be sure to perform operations as specified by these instructions, and never touch any area not specified in the instructions. Sudden movement of the machine may cause injury.

1. Change to the print-head manual-cleaning mode.

1 Remove any media.



Press **MENU**.
Press **▼** several times.



Press **▶**.
Press **▲**.

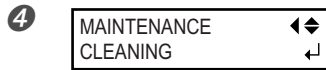

Press **▶**.



Press **ENTER**.

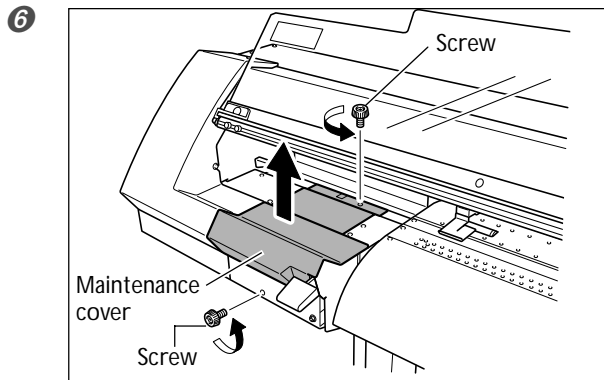

Open the front cover and remove the maintenance cover.



Close the front cover and press **ENTER**.

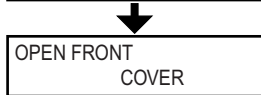

The print-head carriage moves to the left side of the machine, and then the screen shown in the figure appears.

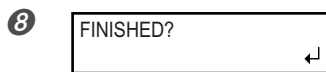

Open the front cover.
Preparations are complete when this screen appears.

2. Remove the side cover.

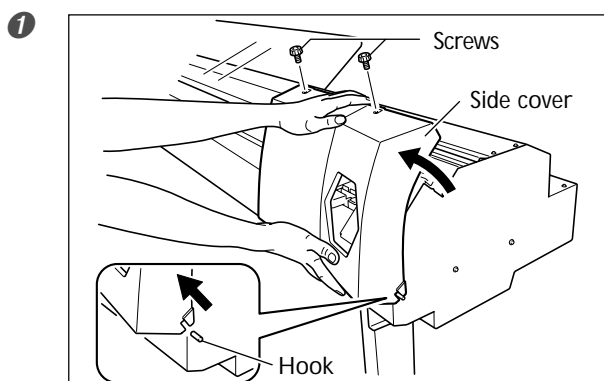

Remove the side cover.

2

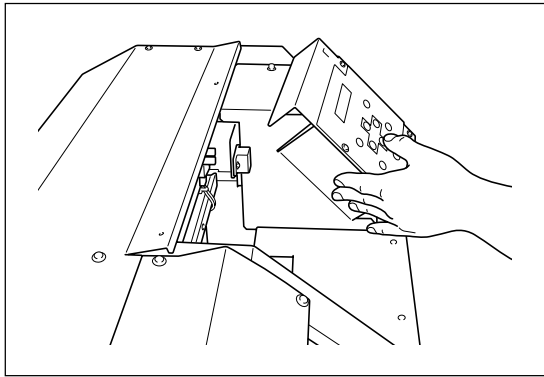

Touch the location shown in the figure to discharge any static electricity.

3. Clean using the cleaning stick. Be especially careful to clean away any fibrous dust (lint).

Clean in the sequence shown in the figure below.



Be sure to clean using one of the included cleaning sticks.

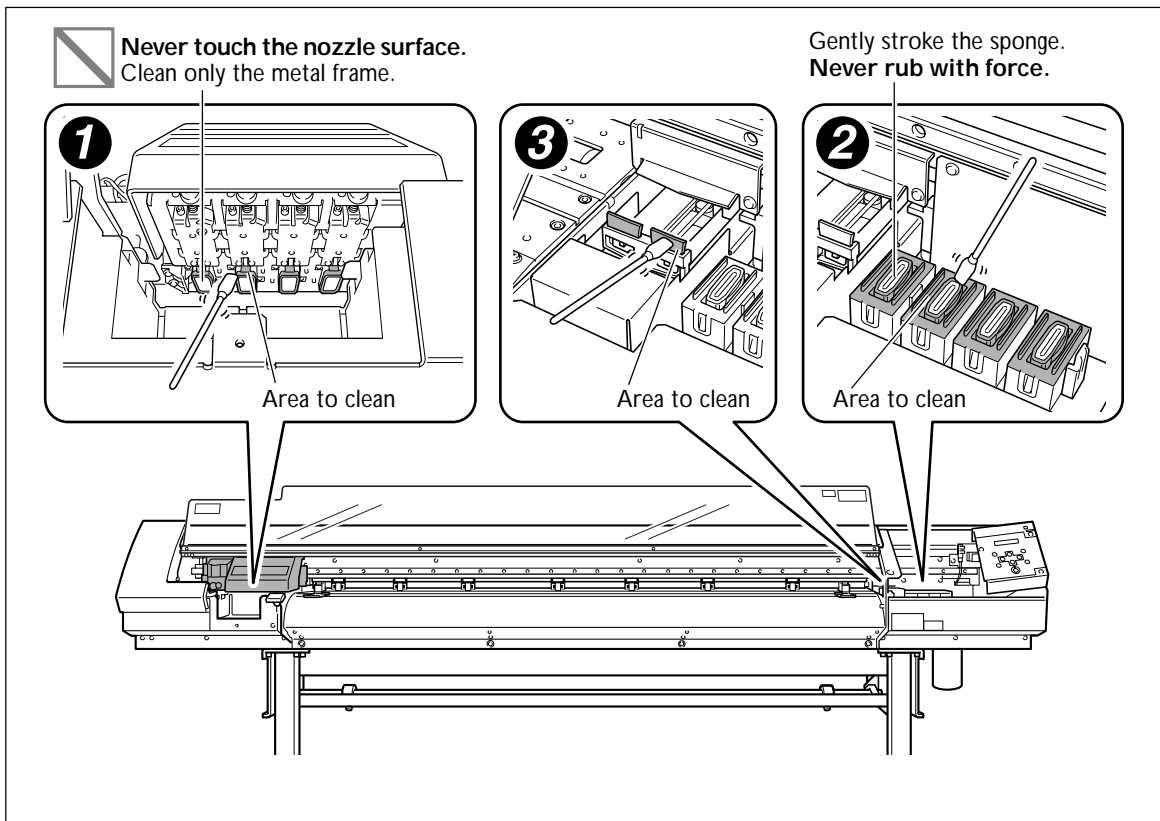

4. Reattach the side cover and the maintenance cover and quit the manual-cleaning mode.

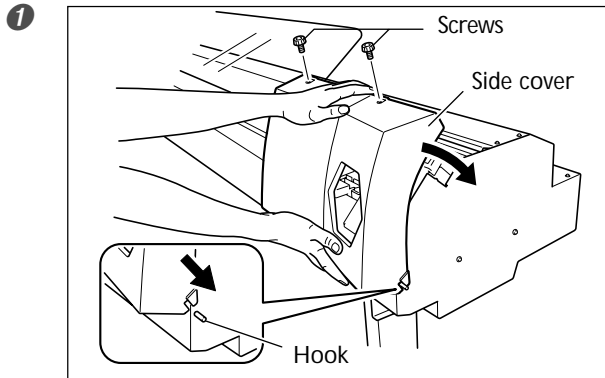

Attach the side cover.

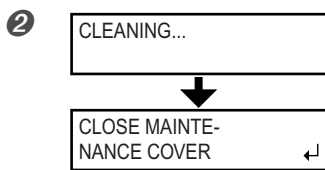

Close the front cover.

Press **ENTER**.

The print-head carriage moves to the right side of the machine, and then the screen shown in the figure appears.

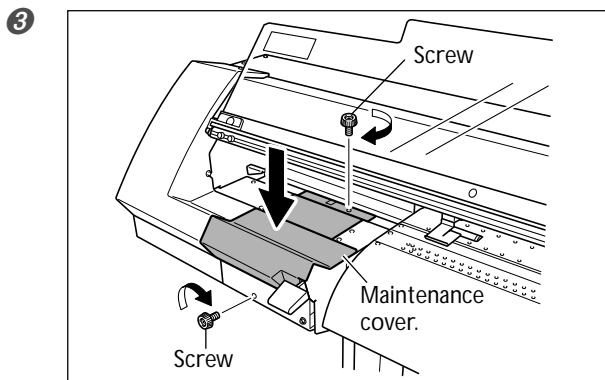

Open the front cover and attach the maintenance cover.

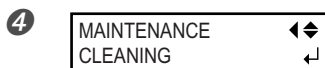

Close the front cover.

Press **ENTER**.

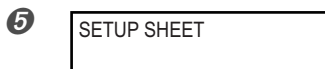

Press **MENU** to go back to the original screen.

5. Perform a printing test to verify the results of the procedure.

Perform a printing test to check the results.

Perform cleaning using the machine's cleaning feature several times when necessary.

☞ P. 42, "Printing Tests and Cleaning"

3-4 Replacing Consumable Parts

Replacing the Wipers



Press **ENTER**.

The wipers are components that you use when cleaning the print heads. When the screen displays a message like the one shown, it means the item needs to be replaced. Replace with new items.

CAUTION Be sure to perform operations as specified by these instructions, and never touch any area not specified in the instructions. Sudden movement of the machine may cause injury.

1. Display the [REPLACE WIPER] menu.

1 Remove any media from the platen.

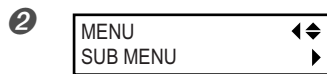

Press **MENU**.
Press **▼** several times.

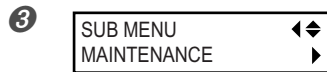

Press **▶**.
Press **▲**.



Press **▶**.
Press **ENTER**.



The print-head carriage moves to a location where wiper replacement is possible, and then the screen shown in the figure appears.

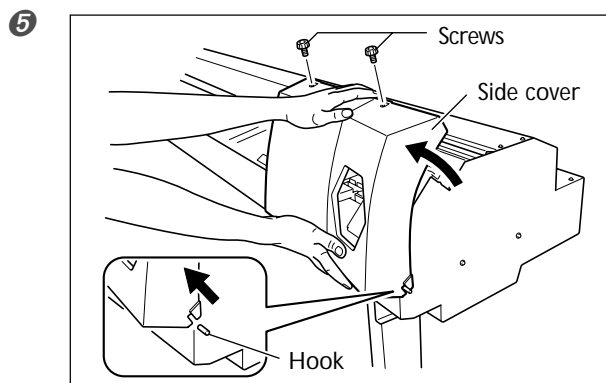

Remove the side cover.

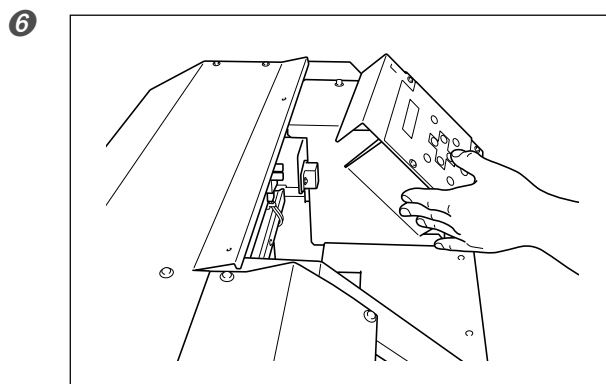

Touch the location shown in the figure to discharge any static electricity.

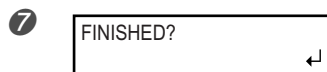

Preparations are complete when this screen appears.

2. Replace the wipers. Use the included tweezers.

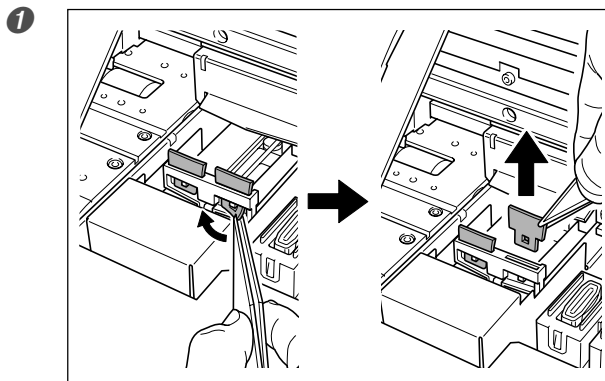

Detach the old wipers.
Detach the hook and pull up and out.

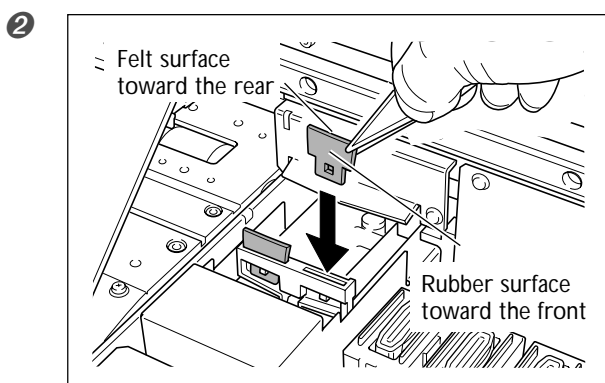

Insert the new wipers.

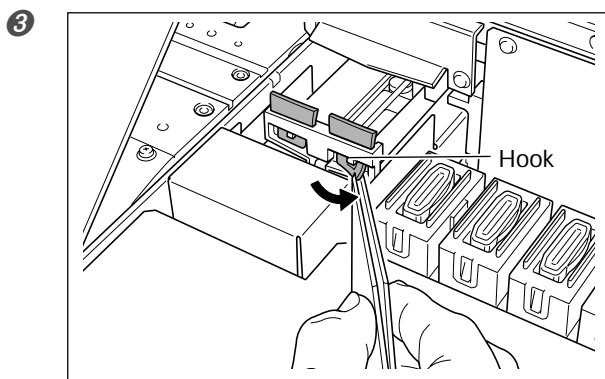

Attach the hook.

3. Reattach the side cover, and quit the wiper replacement mode.

1

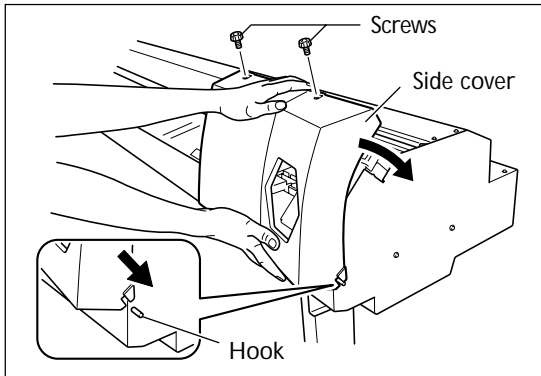

Attach the side cover.

2

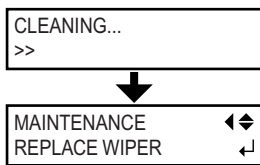

Press **ENTER**.

After the process to quit the wiper replacement mode, the screen shown in the figure appears.

3



Press **MENU** to go back to the original screen.

4 Perform a printing test to verify the results of the procedure.

☞ P. 42, "Printing Tests and Cleaning"

Replacing the Blade

If the blade becomes dull, replace it with the included replacement blade.

⚠ CAUTION Be sure to perform operations as specified by these instructions, and never touch any area not specified in the instructions. Sudden movement of the machine may cause injury.

⚠ CAUTION Never touch the tip of the blade with your fingers. Doing so may result in injury.

1. Enter the blade replacement mode.

① MENU
SUB MENU

Press **MENU**.
Press **▼** several times.

② SUB MENU
MAINTENANCE

Press **▶**.
Press **▲**.

③ MAINTENANCE
REPLACE KNIFE

Press **▶**.
Press **▼** several times.

④ NOW PROCESSING..

Press **ENTER**.

↓
OPEN FRONT
COVER

The cutting carriage moves to a location where blade replacement is possible, and then the screen shown in the figure appears.

⑤ FINISHED?

Open the front cover.
Preparations are complete when this screen appears.

2. Replace the blade.

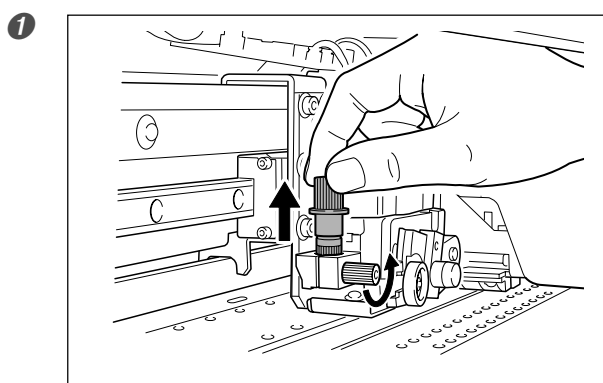

Remove the blade holder.

2

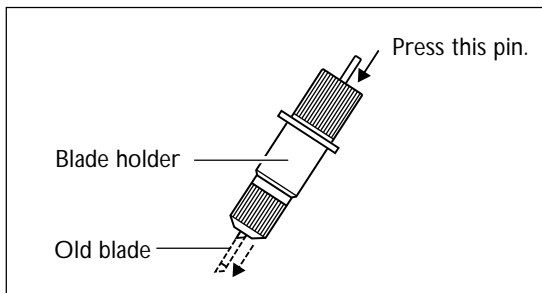

Remove the old blade.

3

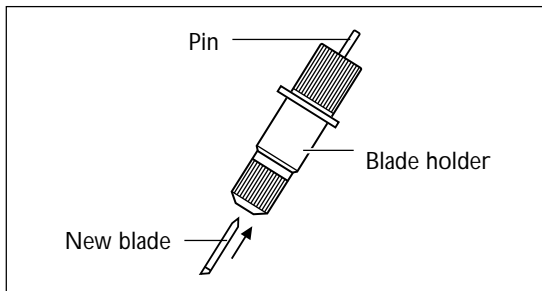

Install a new blade.

4

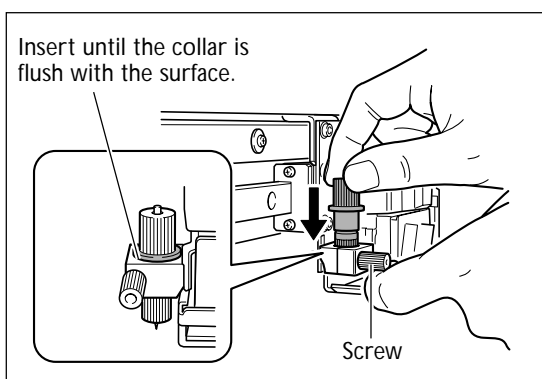

Support the screw from below and insert the blade holder.

5

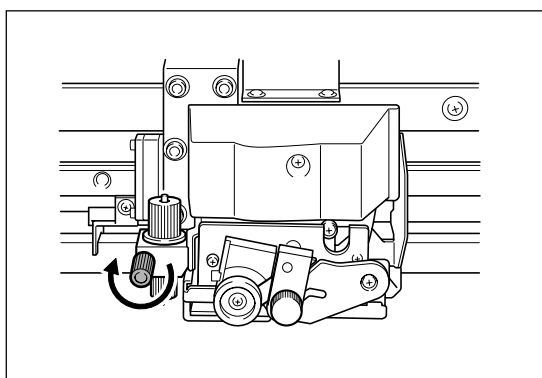

Tighten the screw.

Tug the blade holder upward to make sure it does not come loose.

3. Quit the blade replacement mode.

1

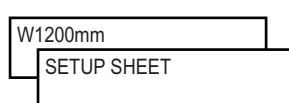

Close the front cover.

Press **ENTER**.

Press **MENU** to go back to the original screen.

Replacing the Separating Knife

If the separating knife becomes dull, replace it with the included replacement knife.

⚠ CAUTION Be sure to perform operations as specified by these instructions, and never touch any area not specified in the instructions. Sudden movement of the machine may cause injury.

⚠ CAUTION Never touch the tip of the separating knife with your fingers. Doing so may result in injury.

1. Enter the blade replacement mode.

1 MENU
SUB MENU

Press **MENU**.
Press **▼** several times.

2 SUB MENU
MAINTENANCE

Press **▶**.
Press **▲**.

3 MAINTENANCE
REPLACE KNIFE

Press **▶**.
Press **▼** several times.

4 NOW PROCESSING..

Press **ENTER**.

↓
OPEN FRONT
COVER

The cutting carriage moves to a location where blade replacement is possible, and then the screen shown in the figure appears.

5 FINISHED?

Open the front cover.
Preparations are complete when this screen appears.

2. Replace the separating knife.

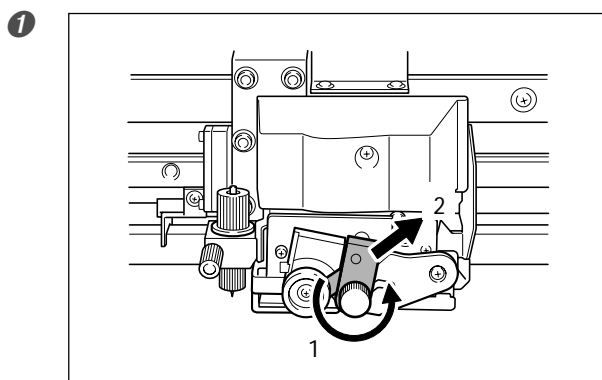

Remove the separating knife.

1. Loosen the screw until it slips out.
2. Grasp the screw portion, and slowly pull it out in the direction of the arrow. When doing this, do not pull it back toward you.

2

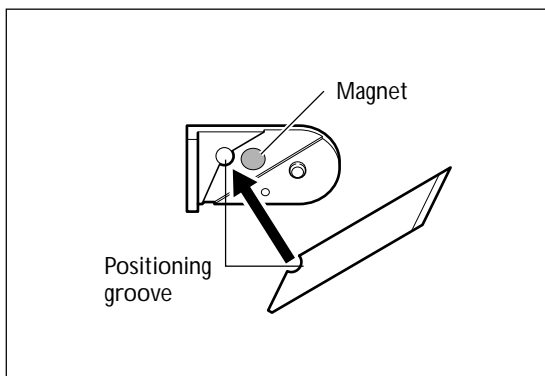

Install a new knife.

The knife is secured in place by the magnet.

3

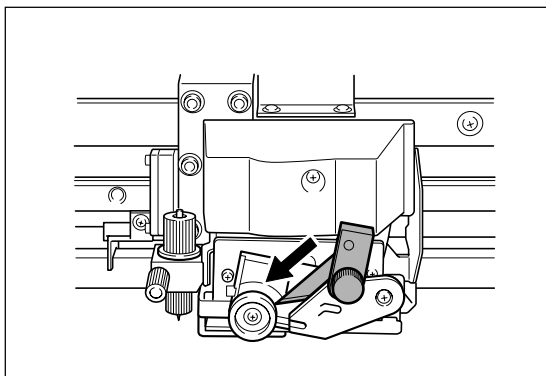

Slowly insert it into the groove.

4

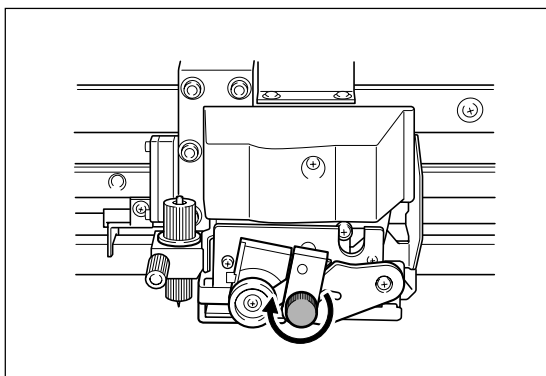

Tighten the screw.

Take care to ensure that the knife does not slip out of position at this time.

3. Quit the blade replacement mode.

1

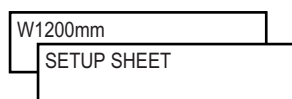

Close the front cover.

Press **ENTER**.

Press **MENU** to go back to the original screen.

3-5 When Not in Use for a Prolonged Period

Keep Performing Maintenance

Switch On the Power Once a Month

Switch on the sub power once a month. When you turn on the power, the machine automatically performs some operations such as those to keep the print heads from drying out. Allowing the machine to stand completely unused for a prolonged period may damage the print heads, so be sure to switch on the power to perform these automatic operations.

Keep at a Constant Temperature and Relative Humidity

Even when the machine is not in use, keep it at a temperature of 5 to 40°C (41 to 104°F) and a relative humidity of 20 to 80% (with no condensation). Temperatures that are too high may degrade the ink and cause malfunction. Temperatures that are too low may cause the ink to freeze and damage the heads.

☞ The Setup Guide also describes what to do when the machine will be out of use for a prolonged period. Be sure to refer to it as well.

Chapter 4

Feature Reference

4-1 Pausing or Canceling Output

Canceling Output Before It Finishes

Procedure

- ①

TO CANCEL, HOLD DOWN PAUSE KEY

 Press **PAUSE**.
The screen shown in the figure appears.
- ② Hold down **PAUSE** for one second or longer.
- ③ Stop sending output data from the computer.

Description

PAUSE pauses printing or cutting.
Pressing **PAUSE** a second time here makes output resume, but in the case of printing, horizontal bands are produced at the place where output stopped. We do not recommend resuming printing.

4-2 Setting the Location for Starting Output

Setting the Output-start Location

Procedure

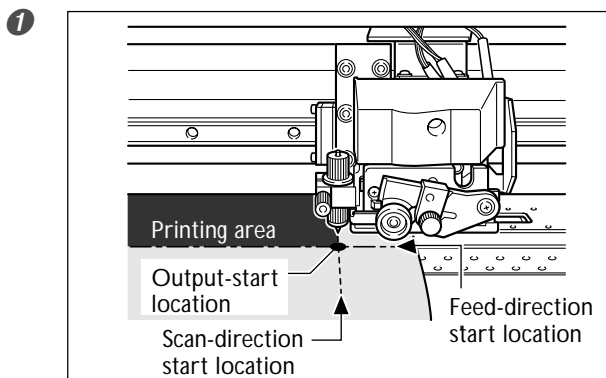

Use to move the cutting carriage.

Align the center of the blade with the new output-start location.

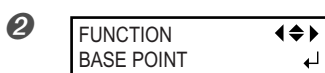

Press .

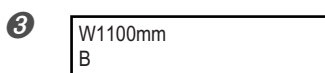

Press to save.

This indicates that the output-start location has been set.

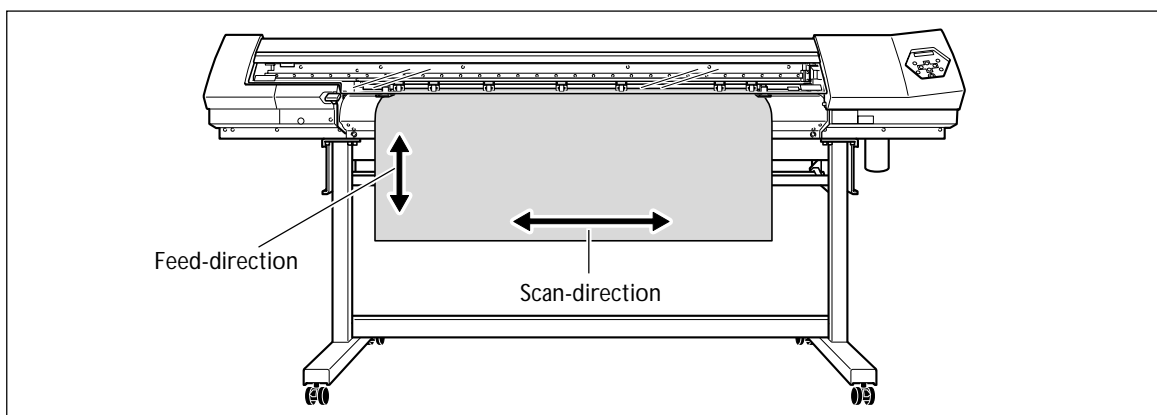

Description

You can set the output-start location at any location you prefer. Note, however, that this setting must be made for each individual page. When the printing of one page finishes, the output-start location returns to its default value. When the start location has been set, **BASE** lights up and screen displays the character "B" together with the output-possible width at the location.



This feature is also available when you're printing or cutting various test patterns, and can help you use media with less waste. Note, however, that the left and right positions are not restored to their defaults for test patterns.

If you're using the separately available media take-up unit, never use . Doing so may pull the media with undue force, resulting in an error or malfunction.

4-3 Saving the Printer Settings to Match the Media

Saving Optimized Media Settings As Preset Values

Procedure

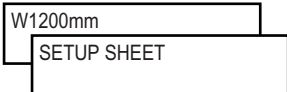
-  Press **MENU**.
-  Press **▶**.
Press **▼**.
-  Press **▶**.
Use **▲** **▼** to select any one from "NAME1" to "NAME8."
Press **ENTER** to save.
The present menu settings are saved in the preset you chose in step **3**.
-  Press **MENU** to go back to the original screen.

Description

Using the [PRESET] menu lets you easily change a wide variety of settings to optimize them for the media. Making changes for each menu item every time you change the media can be troublesome. That's why it can be useful to save the menu-item settings optimized for an often-used type of media as a preset. The next time you use the media, you can change the menu-item settings to the optimal values for the media simply by loading the preset you saved. Menu items that can be saved in presets are listed below.

[PRINT] (Print heater), [DRYER]

☞ P. 39, "Settings for the Media Heating System"

[EDGE DETECTION]

☞ P. 78, "Using Transparent Media"

[SCAN INTERVAL]

☞ P. 78, "Printing Hard-to-dry Media"

[VACUUM POWER]

☞ P. 79, "Preventing Media from Coming Loose"

[FULL WIDTH S]

☞ P. 79, "Speeding Up Output for Narrow Media"

[FEED FOR DRY]

☞ P. 88, "Drying the Trailing Edge of the Printing Area on the Dryer"

[CALIBRATION] (in the [CUTTING MENU])

☞ P. 77, "Performing Distance Correction During Cutting"

[FORCE], [SPEED], [OFFSET], [UP-SPEED]

☞ P. 89, "Fine-tuning the Cutting Conditions"

[ADJUST BI-DIR SIMPLE SETTING]

☞ P. 73, "Correcting for Misalignment in Bidirectional Printing"

[ADJUST BI-DIR DETAIL SETTING]

☞ P. 74, "Correcting for Misalignment in Bidirectional Printing More Precisely"

[CALIBRATION]

☞ P. 76, "Performing Feed Correction to Alleviate Horizontal Bands and the Like"

[PRINT-CUT ADJ.]

☞ P. 92, "Correcting Misalignment of the Printing and Cutting Positions"

[CROP-CUT ADJ.]

☞ P. 99, "Correcting Misalignment for Printing and Cutting When Using Crop Marks"

[PREHEATING]



☞ P. 87, "Determining How the Media Heating System Operates"

Up to eight types of presets can be saved. You can assign a name to each one. Using media names for these may aid recognition and clarity.

☞ P. 71, "Loading a Saved Preset," "Assigning a Name to a Preset"

Loading a Saved Preset

Procedure

- 1  Press **MENU**.
- 2  Press **▶** twice.
Use **▲** **▼** to select the name of a preset you want to load.
- 3  Press **ENTER** to load.
The settings are changed and the screen shown in the figure appears.

Description

This loads a saved preset. You can select any one of eight types of presets. (When no names have been assigned, you select from among NAME1 through NAME8.) If you load a preset while **SETUP** is illuminated, **SETUP** goes dark. If this happens, raise the loading lever, make sure the media is loaded straight, then lower the loading lever again to make output possible.

Assigning a Name to a Preset

Procedure

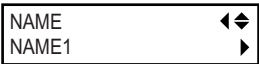
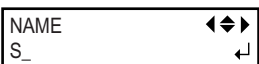
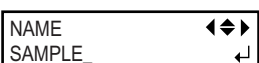
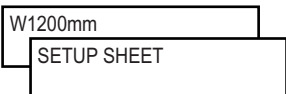
- 1  Press **MENU**.
Press **▶**.
Press **▼** twice.
- 2  Press **▶**.
Use **▲** **▼** to select any one from NAME1 to NAME8.
- 3  Press **▶**.
Use **▲** **▼** to enter a character.
- 4  Press **▶**.
Use **▲** **▼** to enter the next character.
Enter the following characters in the same way.
When you're finished entering text, press **ENTER**.
- 5  Press **MENU** to go back to the original screen.

Description

This assigns a name to a saved preset. Using media names may aid recognition and clarity. The characters you can enter are "A" through "Z," "0" through "9," and the "-" character. You can enter up to 15 characters, including spaces.

4-4 Optimizing Printing or Cutting to Match Media Thickness

Adjusting Head Height to Match Media Thickness (54-inch Model Only)

Procedure



Press .
Press  several times.



Press .

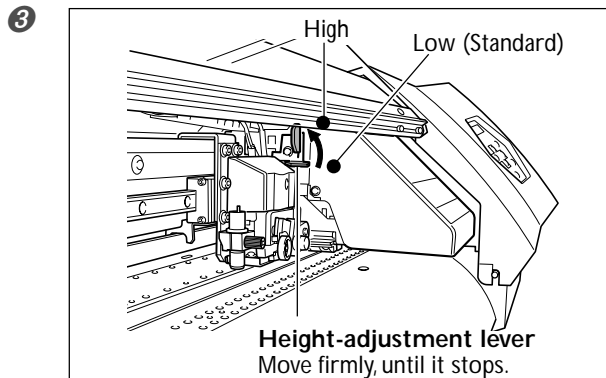

Open the front cover.
Move the Height-adjustment lever to adjust the head height.



Close the front cover.
The print-head carriage moves to the original position, and then the screen shown in the figure appears.



Press  to go back to the original screen.

Description

Depending on the media, media may wrinkle or come loose from the platen during printing, increasing the chance of contact with the print heads. When you are using such media, adjust the head height to "HIGH." (On the 30-inch model, the head height cannot be changed.)







Printing quality when the head height is set to "HIGH" may be coarser or otherwise lower than when set to "LOW." If this happens, refer to the pages indicated below.

☞ P. 73 "Correcting for Misalignment in Bidirectional Printing," p. 74, "Correcting for Misalignment in Bidirectional Printing More Precisely," p. 80, "Preventing Soiling of the Media and Dot Drop-out During Printing"

Correcting for Misalignment in Bidirectional Printing

Procedure





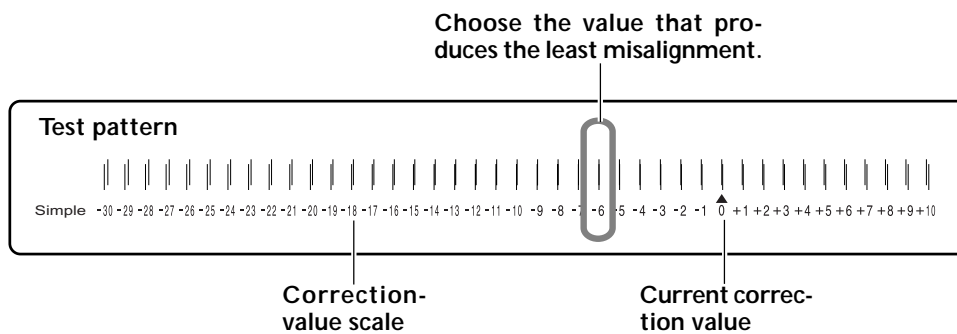

1. Print a test pattern.

- ①  Press .
Press .
- ②  Press .
Press  to start printing.

2. Read the correction values from the test pattern.



3. Enter the correction values that you read.

- ①  Press .
- ②  Press .
Use   to set the correction values.
Press  to enable the setting.

4. Go back to the original screen.

-  Press  to go back to the original screen.

Description

The bidirectional-printing mode (in which the heads perform printing during both their outbound pass and return pass) offers the advantage of being able to shorten output times, but subtle misalignment occurs during the outbound and return passes. The procedure to correct this and eliminate misalignment is bidirectional correction. This misalignment varies according to the head height and the thickness of the media, so we recommend performing correction to match the media you're using.

This settings also serves to correct for misalignment of the printing and cutting positions. In such cases, check or adjust this setting.

☞ P. 92, "Correcting Misalignment of the Printing and Cutting Positions," p. 99, "Correcting Misalignment for Printing and Cutting When Using Crop Marks"

Correcting for Misalignment in Bidirectional Printing More Precisely

Procedure

1. Print a test pattern.

- | | | |
|---|--|---|
| 1 | MENU ◀▶
ADJUST BI-DIR ▶ | Press MENU .
Press ▼ . |
| 2 | ADJUST BI-DIR ◀▶
DETAIL SETTING ▶ | Press ▶ .
Press ▲ . |
| 3 | DETAIL SETTING ◀▶
TEST PRINT ↵ | Press ▶ .
Press ENTER to start printing. |

2. Read the correction values from the test pattern.

Test pattern

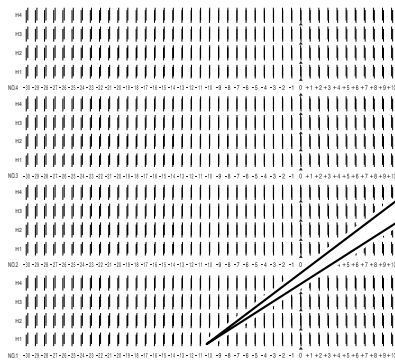

Choose the value that produces the least misalignment.

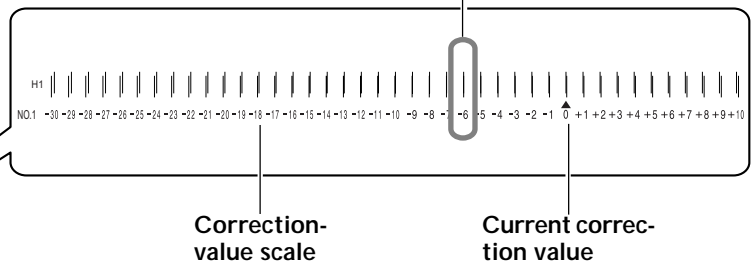

3. Enter the correction values that you read.

Enter the corresponding correction values for H1 through H4.

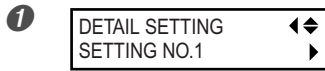

Press .

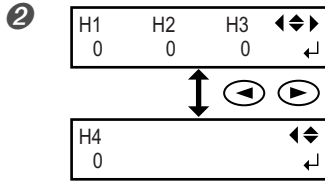

Press .
Use to select. Use to set the correction value.
Press to finish making the settings for [SETTING NO.1].

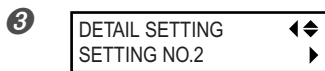

Press .

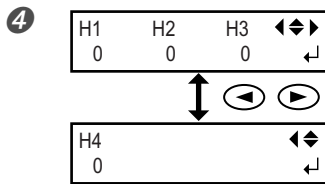

Press .
Use to select. Use to set the correction value.
Press to finish making the settings for [SETTING NO.2].

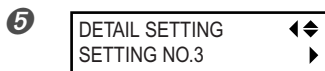

Press .

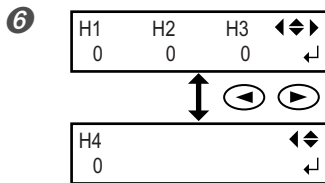

Press .
Use to select. Use to set the correction value.
Press to finish making the settings for [SETTING NO.3].

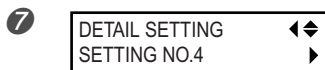

Press .

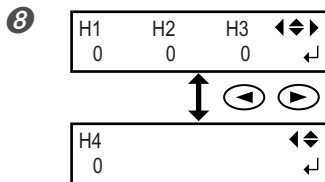

Press .
Use to select. Use to set the correction value.
Press to finish making the settings for [SETTING NO.4].

4. Go back to the original screen.

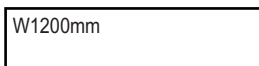

Press to go back to the original screen.







Description

This corrects, for each head, the minute misalignment that occurs in the bidirectional-printing mode. When further correction is required, such as when adjustment made using [SIMPLE SETTING] does not enhance printing, use [DETAIL SETTING] to make corrections for each head.

Performing Feed Correction to Alleviate Horizontal Bands and the Like

Procedure





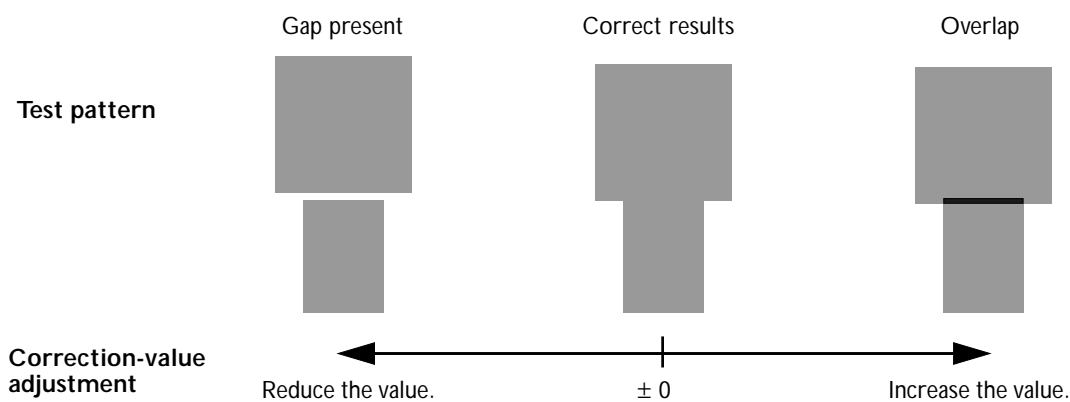

1. Print a test pattern.

- ①  Press .
Press  several times.
- ②  Press .
Press  to start printing.

2. Check the test pattern you printed.



3. Enter the correction value.

-  Press .
Press .
Use   to make the setting for the correction value.
Press  to enable the setting.

4. Go back to the original screen.

-  Press  to go back to the original screen.

Description

The movement distance of media experiences subtle changes due to the thickness of the media and the temperature of the media heating system. When the movement distance becomes discrepant, horizontal stripes are more likely to occur during printing. We recommend performing correction to match the media you're using and the media heating system. Repeat the process of printing a test pattern and entering a correction value several times to find the optimal value.

















Note, however, that you can also make this setting on the computer (by, for example, choosing the media type in the software RIP you are using). Use this feature when you want to make the setting on the printer, without changing any settings on the computer. When you have made the setting on the computer, the computer's setting is used and the printer's setting is ignored.

Default Setting

[SETTING]: 0.00%

Performing Distance Correction During Cutting

Procedure

- | | |
|--|--|
| <p>1</p> <div style="border: 1px solid black; padding: 2px; display: inline-block;"> MENU
CUTTING MENU </div> | <p>Press  .
Press  .</p> |
| <p>2</p> <div style="border: 1px solid black; padding: 2px; display: inline-block;"> CUTTING MENU
CALIBRATION </div> | <p>Press  .
Press  several times.</p> |
| <p>3</p> <div style="border: 1px solid black; padding: 2px; display: inline-block;"> CALIBRATION
FEED SETTING </div> | <p>Press  .</p> |
| <p>4</p> <div style="border: 1px solid black; padding: 2px; display: inline-block;"> FEED SETTING
0.00% ▶ 0.00% </div> | <p>Press  .
Use   to make the setting for the correction value.
Press  to enable the setting for [FEED SETTING].</p> |
| <p>5</p> <div style="border: 1px solid black; padding: 2px; display: inline-block;"> CALIBRATION
SCAN SETTING </div> | <p>Press  .
Press  .</p> |
| <p>6</p> <div style="border: 1px solid black; padding: 2px; display: inline-block;"> SCAN SETTING
0.00% ▶ 0.00% </div> | <p>Press  .
Use   to make the setting for the correction value.
Press  to enable the setting for [SCAN SETTING].</p> |
| <p>7</p> <div style="border: 1px solid black; padding: 2px; display: inline-block;"> W1200mm
SETUP SHEET </div> | <p>Press  to go back to the original screen.</p> |

Description

The movement distance of the media changes subtly depending on the media's thickness. This means that the length of a line when cut may differ from the length setting in the data. You enter a correction value when you want to align the lengths of cut lines precisely.

However, when you're performing printing followed by cutting, be sure to set the correction value to "0.00%." Otherwise the printing and cutting positions may become misaligned.



Default Setting

[FEED SETTING]: 0.00%
[SCAN SETTING]: 0.00%

4-5 Accommodating Various Kinds of Media

Using Transparent Media

Procedure

-  Press **MENU**.
Press **▼** several times.
-  Press **▶** twice.
Use **▲** **▼** to select "DISABLE."
-  Press **ENTER** to enable the setting.
The settings are changed and the screen shown in the figure appears.

Description

This setting enables or disables detection of the leading and trailing edges of the media. It is normally set to "ENABLE." When transparent media is loaded, set it to "DISABLE."



When [EDGE DETECTION] is set to "DISABLE," printing operation does not stop when the media runs out. If media runs out while printing is in progress, immediately press **PAUSE** to quit printing. Otherwise, there is a chance that the platen or the like may become soiled by ink or that ink may get inside and damage the machine.

Default Setting

[EDGE DETECTION]: ENABLE

Printing Hard-to-dry Media

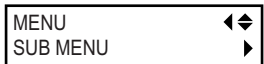
Procedure

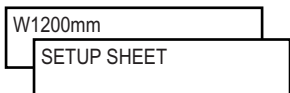
-  Press **MENU**.
Press **▼** several times.
-  Press **▶**.
Press **▼**.
-  Press **▶**.
Use **▲** **▼** to set the value.
Press **ENTER**.
-  Press **MENU** to go back to the original screen.

Description

You use this when ink dries poorly even when the media heating system is used. Larger values produce progressively slower movement of the media, enabling you to extend the drying time accordingly. Printing time takes correspondingly longer.

You can also make this setting on the computer. When you have made the setting on the computer, the computer's setting is used and the printer's setting is ignored.

Default Setting

[SCAN INTERVAL]: OFF

Preventing Media from Coming Loose

Procedure

- 1



Press **MENU**.
Press **▼** several times.
- 2



Press **▶**.
Press **▼** twice.
- 3

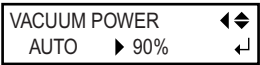

Press **▶**.
Use **▲** **▼** to set the value.
Press **ENTER** to enable the setting.
- 4

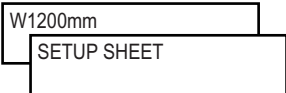

Press **MENU** to go back to the original screen.

Description

The platen uses suction to grip the media and keep it stable. When media comes loose from the platen because it is warped or wrinkled, increasing the suction force may help correct the problem. Conversely, when the media is flimsy and cannot move smoothly, reducing the suction force may help.

When set to "AUTO," the suction force is automatically adjusted to the optimal level for the media width.

You can also make this setting on the computer. When you have made the setting on the computer, the computer's setting is used and the printer's setting is ignored.

Default Setting

[VACUUM POWER]: AUTO

Speeding Up Output for Narrow Media

Procedure

- 1

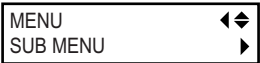

Press **MENU**.
Press **▼** several times.
- 2

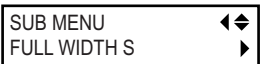

Press **▶**.
Press **▼** several times.
- 3



Press **▶**.
Use **▲** **▼** to select "SHEET" or "OFF."
Press **ENTER** to enable the setting.
- 4

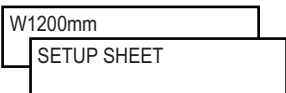

Press **MENU** to go back to the original screen.

Description

This shortens output time by reducing the width of head movement to the minimum necessary. This is effective when the width of the media or the output data is narrow.

"SHEET" matches the range of head movement to the width of the media.

"OFF" matches the range of head movement to the output data. Movement is limited to the minimum amount necessary, and this can be expected to yield the fastest output. Note, however, that because the speed of media movement is no longer constant, colors may be uneven.











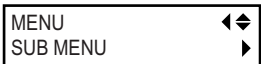

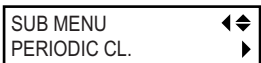
"FULL" makes the speed of media movement constant at all times.

Default Setting

[FULL WIDTH S]: FULL

Preventing Soiling of the Media and Dot Drop-out During Printing

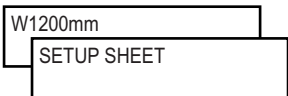
Procedure

- 1  Press  .
Press  several times.
- 2  Press  .
Press  several times.
- 3  Press  .
Use   to select a value from "10 min" to "990 min," or "PAGE."
Press  to enable the setting.
- 4  Press  to go back to the original screen.

Description

Ink tends to collect on the surface of the heads when you use media prone to buildup of static charge, when the ambient temperature is low, or when the head height is set to "HIGH." Under some conditions, this ink may be transferred to the media or cause dot drop-out. Use this feature at such times. The ink buildup is removed as printing is performed.

When this is set to "PAGE," automatic cleaning is performed every time before printing starts.

When this is set to a value from "10 min" to "990 min," automatic cleaning is performed when the cumulative printing time reaches the value you set here.

When this is set to "NONE," no automatic cleaning is performed.

Using "PAGE" or a value from "10 min" to "990 min," results in longer printing times. Also, when this is set to a value from "10 min" to "990 min," printing pauses and so colors may be uneven.

☞ P. 72, "Adjusting Head Height to Match Media Thickness (54-inch Model Only)"

Default Setting

[PERIODIC CL.]: NONE

Printing Media That Warps Easily

Procedure

1. Change the setting for the [MEDIA CLAMP] menu item to [LONG].

- 1**

MENU	◀▶
MEDIA CLAMP	▶

Press **MENU**.
Press **▲** several times.
- 2**

MEDIA CLAMP	◀▶
SHORT ▶ LONG	◀▶

Press **▶**.
Use **▲** **▼** to select "LONG."
Press **ENTER** to enable the setting.
- 3**

W1200mm
SETUP SHEET

Press **MENU** to go back to the original screen.

2. Replace the short media clamps with the long ones.

- 1** Remove the short media clamps.

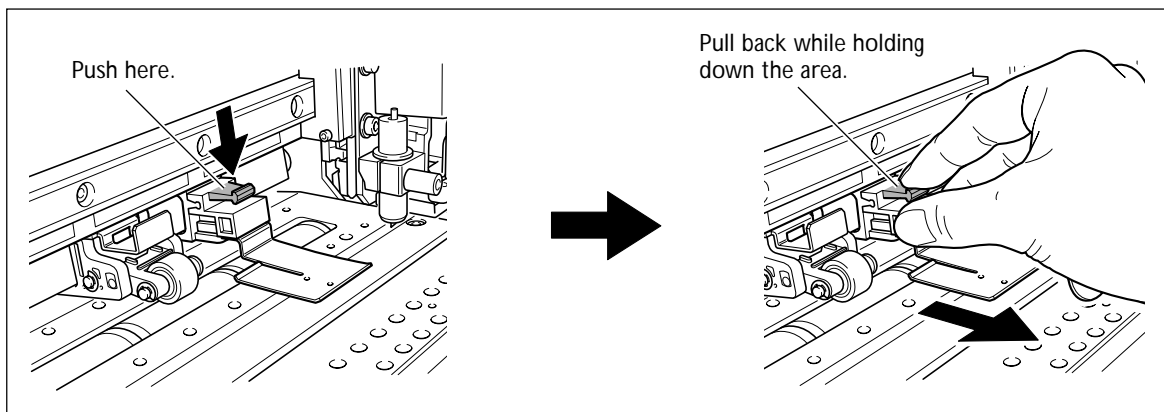

- 2** Attach the long media clamps.

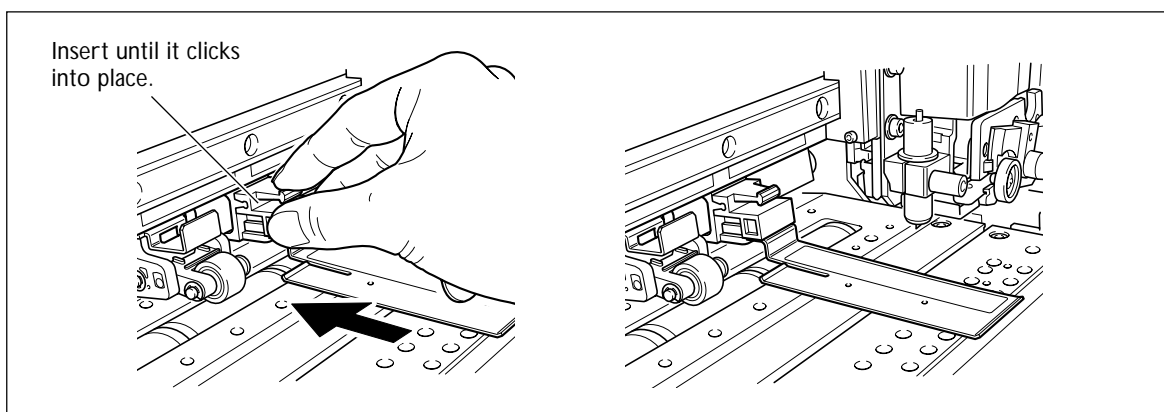

Description

When you want to hold the media in place more securely, such as when you're printing media that warps easily, use the long media clamps to secure the edges of the media in place.

Note that when you're attaching the long media clamps, be sure to make the setting described above so that the media-cutoff operation cannot be performed. Performing media cutoff with the long media clamps installed may cause the long media clamps to touch the separating knife, resulting in damage or malfunction.

When the [MEDIA CLAMP] menu item is set to [LONG], media cutoff is not performed.

☞ P. 38, "Cutting Off the Media"

How to Load Sheet Media

When you're loading standard-size media or other such media that is not rolled (sheet media), follow the procedure below.

Procedure

1

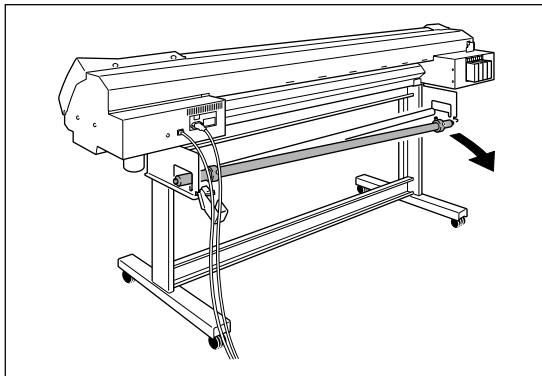

Remove both shafts.

If roll media is loaded, then remove the media first.

2

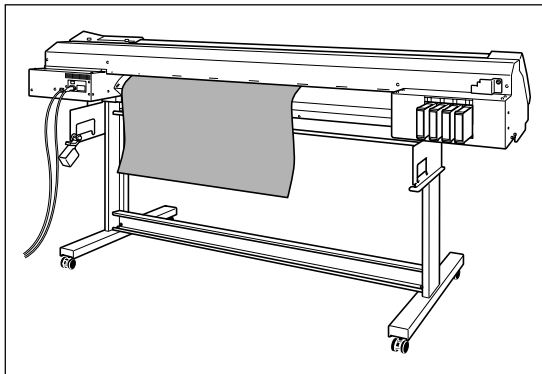

Pass the media through the machine.

3

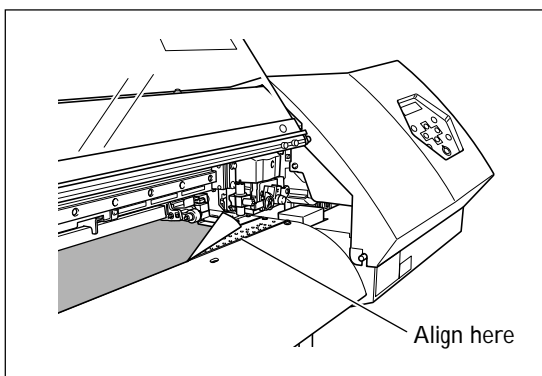

Align the front edge of the media with the location shown in the figure.

- ④ Lower the loading lever to secure the media in place.
- ⑤ If you're performing printing, attach the media clamps and close the front cover.

See also the following pages.

☞ P. 32, "Loading Media"

4-6 Changing How the Printer Operates

Executing Environment Matching Automatically

Procedure

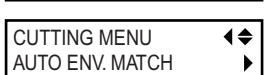
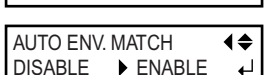
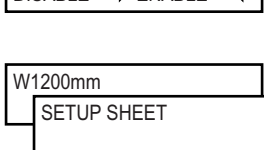
-  Press **MENU** .
Press **▲** .
-  Press **▶** .
Press **▲** .
-  Press **▶** .
Use **▲** **▼** to select "ENABLE."
Press **ENTER** to enable the setting.
-  Press **MENU** to go back to the original screen.

Description

This setting enables or disables the feature for automatic adjustment to optimize the state of the machine to the environment where it is used (temperature and humidity). Performing automatic adjustment can reduce misalignment in the scanning direction (the direction of carriage movement) during printing or cutting. It is normally set to "ENABLE."

Default Setting

[AUTO ENV. MATCH]: ENABLE

Determining What Happens When Ink Runs Out

Procedure

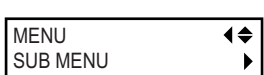
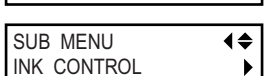
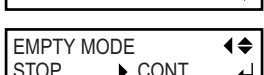
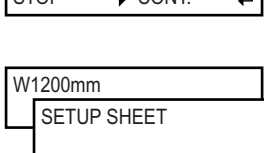
-  Press **MENU** .
Press **▼** several times.
-  Press **▶** .
Press **▲** twice.
-  Press **▶** twice.
Use **▲** **▼** to make the setting.
Press **ENTER** to enable the setting.
-  Press **MENU** to go back to the original screen.

Description

This lets you change, according to your purpose, the operation that takes place when an ink cartridge is empty. "STOP" immediately pauses operation when a cartridge becomes empty. Because pausing printing in progress may make colors uneven, it is best to ensure a sufficient amount of remaining ink before you begin printing. "CONT." (continue) is a mode in which operation is not automatically stopped. When a cartridge becomes empty, a



warning beep sounds but printing doesn't stop. To replace the cartridge, you must either wait until printing ends or press **PAUSE** to pause printing. Note that operation does not stop even if ink runs out completely.

Default Setting

[EMPTY MODE]: STOP

Setting the Interval until Activation of the Sleep Mode

Procedure

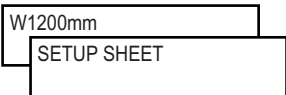

- 1**  Press **MENU**.
Press **▼** several times.
- 2**  Press **▶**.
Press **▲** several times.
- 3**  Press **▶** twice.
Use **▲** **▼** to make the setting.
Press **ENTER** to enable the setting.
- 4**  Press **MENU** to go back to the original screen.

Default Setting

[INTERVAL]: 30min

Deactivating the Sleep Mode

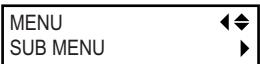
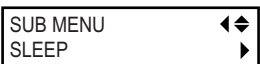
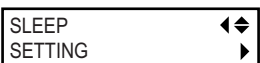
Procedure

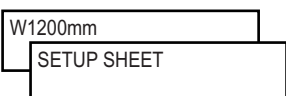
- 1**  Press **MENU**.
Press **▼** several times.
- 2**  Press **▶**.
Press **▲** several times.
- 3**  Press **▶**.
Press **▼**.
- 4**  Press **▶**.
Use **▲** **▼** to select "DISABLE."
Press **ENTER** to enable the setting.
- 5**  Press **MENU** to go back to the original screen.

Default Setting

[SETTING]: ENABLE

Changing the Menu Language and the Units of Measurement

Procedure

- | | |
|--|--|
| <p>1</p> <div style="border: 1px solid black; padding: 2px; display: inline-block;"> MENU LANGUAGE
 ENGLISH </div> | <p>Hold down MENU and switch on the sub power.
 Use ▲ ▼ to select the display (menu) language.
 Press ENTER.</p> |
| <p>2</p> <div style="border: 1px solid black; padding: 2px; display: inline-block;"> LENGTH UNIT
 mm ▶ INCH </div> | <p>Use ▲ ▼ to select the measurement unit for length.
 Press ENTER.</p> |
| <p>3</p> <div style="border: 1px solid black; padding: 2px; display: inline-block;"> TEMP. UNIT
 °C ▶ °F </div> | <p>Use ▲ ▼ to select to the measurement unit for tempera-
 ture.
 Press ENTER.</p> |

Description

This sets the language and units of measurement displayed on the display screen of the operation panel.

Default Setting

[MENU LANGUAGE]: ENGLISH
 [LENGTH UNIT]: mm
 [TEMP. UNIT]: °C

Returning All Settings to Their Initial Values

Procedure

- | | |
|--|---|
| <p>1</p> <div style="border: 1px solid black; padding: 2px; display: inline-block;"> MENU
 SUB MENU </div> | <p>Press MENU.
 Press ▼ several times.</p> |
| <p>2</p> <div style="border: 1px solid black; padding: 2px; display: inline-block;"> SUB MENU
 FACTORY DEFAULT </div> | <p>Press ▶.
 Press ▼ several times.
 Press ENTER to execute.</p> |



Description

This menu returns all settings to the same as their factory defaults. However, the settings for [LANGUAGE], [LENGTH UNIT], and [TEMP. UNIT] are not returned to the factory defaults.

4-7 Changing the Ink-drying Method

Switching Off the Print Heater and Dryer

Procedure

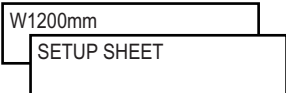
-  Press **FUNCTION**.
Press **▼** several times.
-  Press **▶**.
Use **▲** **▼** to select [PRINT] (print heater) or [DRYER] (dryer).
↑
Current temperature of the dryer
-  Press **▶**.
Use **▲** **▼** to select "OFF."
Press **ENTER** to enable the setting.
↑
Current preset temperature
-  Press **FUNCTION** to go back to the original screen.

Description

This menu is used to make the temperature settings for the print heater and dryer, and you can also use it to turn these off. When set to "OFF," the print heater and dryer do not operate at all.

Note, however, that you can also make this setting on the computer. When you have made the setting on the computer, the computer's setting is used and the printer's setting is ignored.



Default Setting

[PRINT] (print heater) : 35°C (94°F)

[DRYER] (dryer) : 40°C (104°F)

Determining How the Media Heating System Operates

Procedure

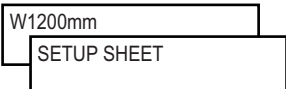
-  Press **MENU**.
Press **▼** several times.
-  Press **▶**.
Press **▼**.
-  Press **▶**.
Use **▲** **▼** to make the setting.
Press **ENTER** to enable the setting.
-  Press **MENU** to go back to the original screen.

Description



This feature controls the temperature of the media heating system automatically when [SETUP] is dark.
"MENU" performs heating to the preset temperature at all times, without lowering the temperature when [SETUP] is dark.
"30°C" lowers the temperature of the media heating system to a fixed temperature (30°C) when [SETUP] is dark.
"OFF" switches off the media heating system when [SETUP] is dark.

Default Setting

[PREHEATING]: 30°C

Drying the Trailing Edge of the Printing Area on the Dryer

Procedure

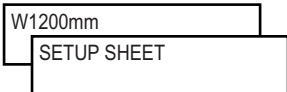
-  Press [MENU].
Press [DOWN] several times.
-  Press [RIGHT] twice.
Use [UP] and [DOWN] to select "ENABLE."
Press [ENTER] to enable the setting.
-  Press [MENU] to go back to the original screen.

Description

When this menu item is set to "ENABLE," additional media feed is performed until the trailing edge of the printing area is positioned directly on the dryer. The margin between the print-end position and the next print-start position is set to a value of 100 millimeters.

When a margin setting of less than 100 millimeters has been made on the computer, that setting is ignored and a margin value of 100 millimeters is used.

However, when a margin setting of greater than 100 millimeters has been made on the computer, the computer's setting is used for the margin value.

When this is set to "DISABLE," media feed stops simultaneously when printing ends. This means that the trailing edge of the printing area is not fed to the dryer unless you continue with a subsequent printing operation.



Default Setting

[FEED FOR DRY]: DISABLE

4-8 Making Various Adjustments for Cutting

Making the Cutting Conditions Set on the Machine Take Precedence

Procedure

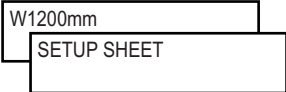
-  Press **MENU**.
Press **▲**.
-  Press **▶**.
Press **▲** several times.
-  Press **▶**.
Use **▲** **▼** to select "MENU."
Press **ENTER** to enable the setting.
-  Press **MENU** to go back to the original screen.

Description



You can also make the settings for the cutting conditions using the computer. By default, the settings made with the computer take priority. To make the cutting conditions set on the machine take priority, either turn off the settings of the computer or make the setting described above.

Default Setting

[CUTTING PRIOR]: COMMAND

Fine-tuning the Cutting Conditions

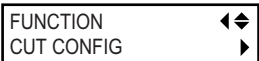
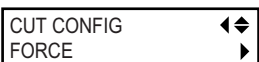
Procedure

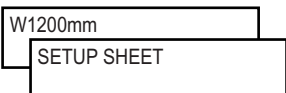
-  Press **FUNCTION**.
Press **▼** several times.
-  Press **▶**.
Use **▲** **▼** to choose the cutting condition you want to set.
-  Press **▶**.
Use **▲** **▼** to enter the value.
Press **ENTER** to enable the setting.
-  Press **FUNCTION** to go back to the original screen.

Description

This enables you to check and verify the settings for the cutting conditions using cutting-test results.

⇨ P. 46, "Performing a Cutting Test"

4-8 Making Various Adjustments for Cutting

[FORCE]: This sets the force (pressure) of the blade.

[SPEED]: This sets the speed of cutting.

[OFFSET]: This makes the blade-offset setting for the blade. Enter the listed offset value for the blade. (The offset value for the included blade is 0.25 mm.)

[UP-SPEED]: This sets the blade's up speed during cutting (the speed at which the blade travels when it moves to the next cutting line after cutting one cutting line). If the media comes loose during no-load feed and the blade damages the surface of the media, reduce the speed.

Evaluating the Results of a Cutting Test

1 Check the shape of the test pattern.

The cut shape is distorted.

Reduce the cutting speed.

2 Peel off circle 1.

Rectangle 2 also peels off.

Increase the blade force.

Some uncut areas remain.

Reduce the cutting speed.

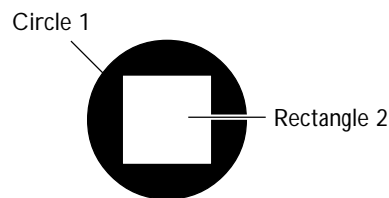

3 Peel off rectangle 2.

The blade should leave faint traces on the backing paper.

The blade trace is indistinct.

Increase the blade force.

The blade trace is too deep and cuts into the backing paper.

Reduce the blade force.

4 Check the shape of rectangle 2.

A. The shape is correct.

B. The corners are rounded.

Increase the amount of blade offset.

C. The corners have "horns."

Reduce the amount of blade offset.

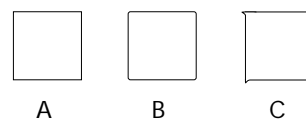

Accurately Adjusting the Cutting-in Amount

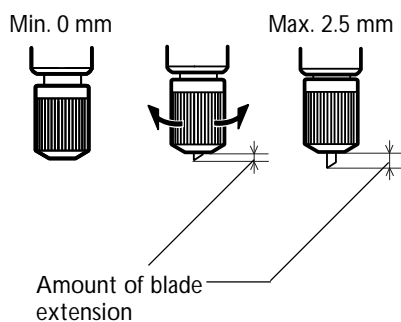

When you want to perform accurate and fine adjustment of the cutting-in amount, such as when cutting media with thin backing paper, you can obtain good results by adjusting the tip of the blade. Turn the cap portion of the blade holder to adjust the amount of blade extension. Each indicator tick corresponds to 0.1 millimeters, and adjustment for 0.5 millimeters can be made by rotating the cap one full turn.

Note that making the amount of blade extension too small may cause the end of the cap for the blade holder to touch and damage the printed surface. It's important to be especially careful about this when you're using media that has poor ink-adhesion properties.

Rough Estimate for the Amount of Blade Extension





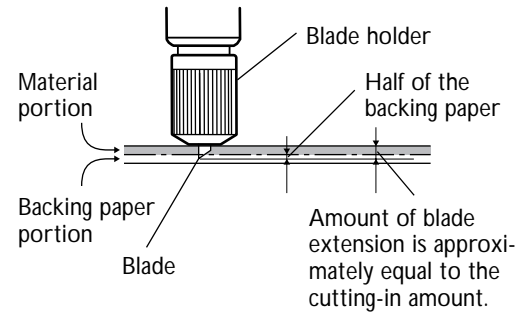





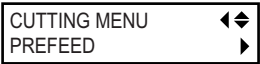

Use the following dimension as a rough estimate for setting the amount of blade extension.

$$\text{Amount of blade extension} = \text{Thickness of the material portion} + \frac{\text{Thickness of the backing paper}}{2}$$

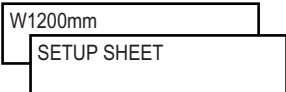

Preventing Pulling of the Media with Undue Force When Performing Cutting Only

Procedure

- 1  Press .
Press .
- 2  Press .
Press  several times.
- 3  Press .
Use  and  to select "ENABLE."
Press  to enable the setting.
- 4  Press  to go back to the original screen.

Description

When you're performing cutting only, it may be convenient to set this feature to "ENABLE." This feeds out media according to the size of the data sent from the computer before performing cutting. This makes it unnecessary to turn the media flanges by hand to feed out media every time you perform cutting. Note, however, that this feeds out media even when you're performing printing only, so set it to "DISABLE" when not needed.

Default Setting

[PREFEED]: DISABLE

Correcting Misalignment of the Printing and Cutting Positions

Procedure

1. Check the setting for the [AUTO ENV. MATCH] menu item.

Make sure the [AUTO ENV. MATCH] menu item is set to "ENABLE."

☞ P. 84, "Executing Environment Matching Automatically"

2. Execute the [ADJUST BI-DIR] menu item.

① Load the media.

☞ P. 32, "Loading Media"

☞ P. 82, "How to Load Sheet Media"

② Perform bidirectional adjustment.

☞ P. 73, "Correcting for Misalignment in Bidirectional Printing"

☞ P. 74, "Correcting for Misalignment in Bidirectional Printing More Precisely"

3. Print a test pattern and cut it.

① MENU ◀▶
CUTTING MENU ▶

Press .
Press .

② CUTTING MENU ◀▶
PRINT - CUT ADJ. ▶

Press .

③ PRINT - CUT ADJ. ◀▶
TEST PRINT ↵

Press .
Press .

The test pattern is printed at three locations: at the two edges and in the center.

When adjustment is needed, go on to the steps below.

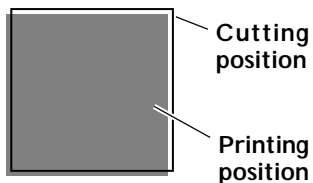

Cutting position and printing position are misaligned.

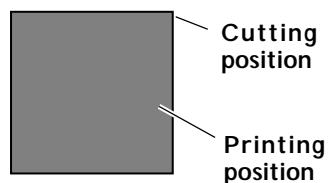

Cutting position and printing position are aligned.

4. Print and cut a test pattern for setting the correction values.

PRINT - CUT ADJ. ◀▶
TEST PRINT 2 ↵

Press .
Press  to execute.

5. From the test pattern, read the value at the location.

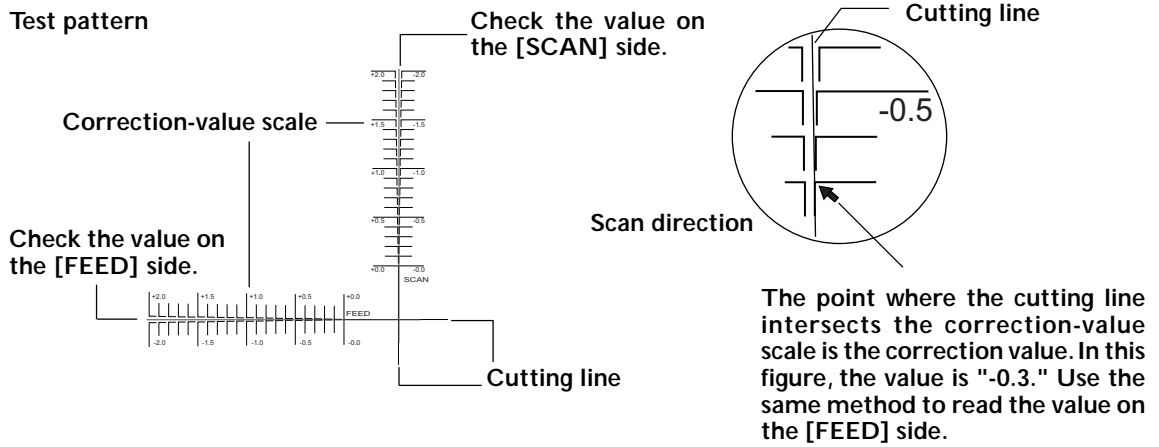

6. Enter the correction value you read.



Press .



Press .

Use to set the correction value for [F] (the feed direction).

Use to set the correction value for [S] (the scanning direction).

Press to enable the setting.



Press .

7. Check the results of adjustment.



Press .

Press to execute.

If the printing and cutting lines are aligned, adjustment is complete.

If further adjustment is needed, go back to step 6. and fine-tune the adjustment.

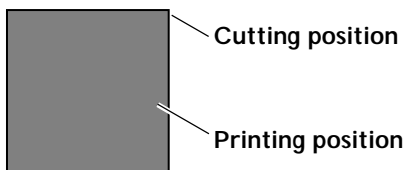

Cutting position and printing position are aligned.

Description

You perform this when printing followed immediately by cutting yields positioning for printing and cutting that is slightly misaligned. You print alignment marks, perform detection of the printed marks, and correct the discrepancy. Subtle misalignment between the printing and cutting positions may occur due to the thickness of the media or the head height. We recommend making correction to match the media you're using.

Default Setting

[F] (feed direction): 0.00 mm
[S] (scanning direction): 0.00 mm

4-9 Performing Printing and Cutting Separately

To Perform Printing and Cutting Separately

When you remove printed media and then reload it and perform cutting, you carry out alignment to prevent misalignment of the printing results and the cut lines. You do this at times such as when, for example, you perform lamination or other processing after printing, then reload the media and perform cutting. At such times, you perform printing with crop marks. You can perform automatic alignment with detection of the printed crop marks when you perform cutting.

Printing with Crop Marks

Use your software RIP to make the settings for printing crop marks. For information on how to make the setting, refer to the documentation for the software RIP you're using. Alignment marks and symbols drawn using a graphics program cannot be used as crop marks.

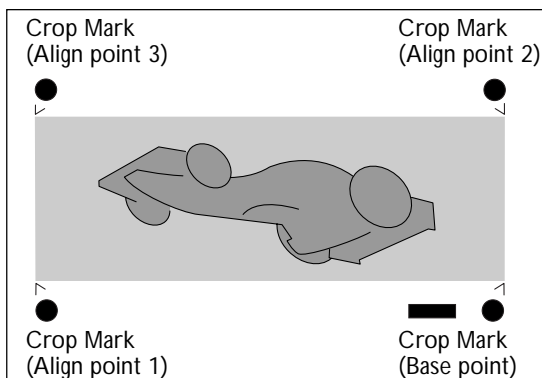

The crop marks are printed as shown in the figure.

Media Sizes Allowing Automatic Crop Mark Detection

When you are printing with crop marks, set a margin of at least 90 mm (3.5 in.) before the next print-start position. You can set the margin value with the software RIP you're using. For information on how to make the setting, refer to the documentation for the software RIP you're using.

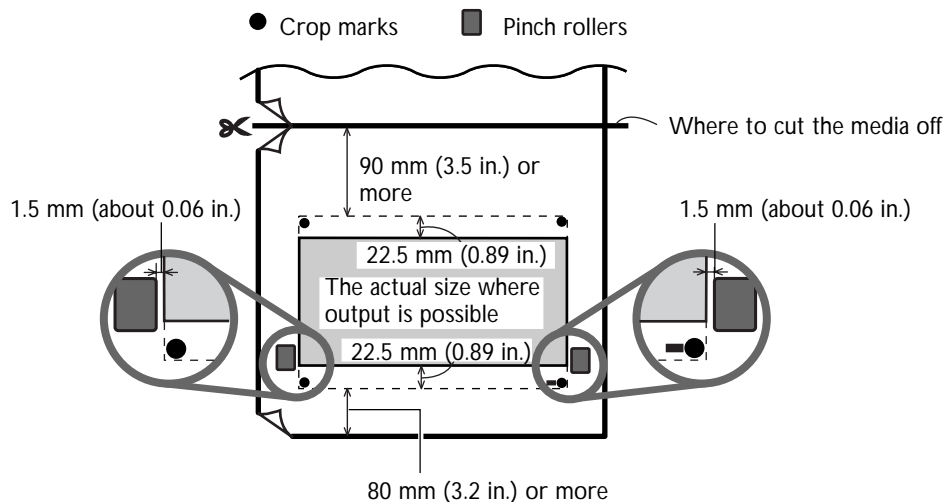

Aligning Automatically and Cutting

When you make the setting for reading crop marks when sending cutting data from the computer, alignment is performed with the presence or absence of crop marks determined automatically. For information on how to make the setting, refer to the documentation for the software RIP you're using.

Procedure

1

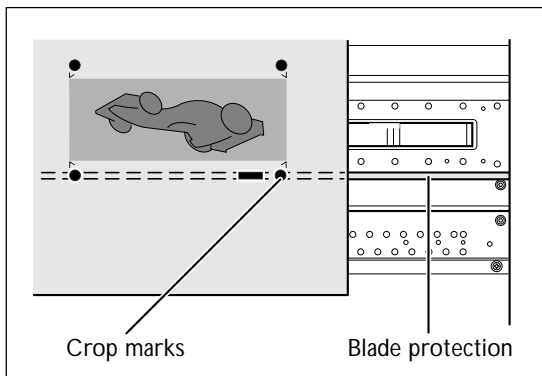

Load the media.

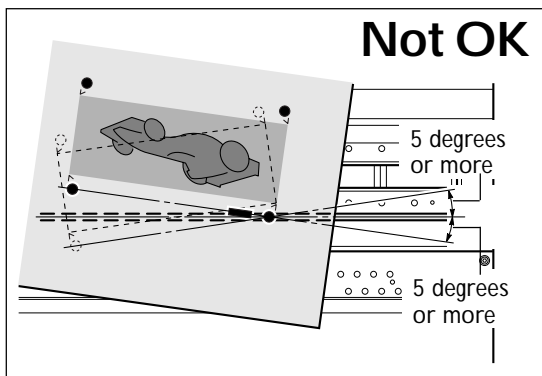

Angled no more than 5 degrees.
Otherwise alignment becomes impossible.

2

Send the cutting data.

Alignment is performed automatically, then cutting starts.

If Automatic Alignment Cannot Be Performed



If the machine fails to detect the crop marks, the screen shown in the figure appears and operation stops.

If this happens, press **ENTER**, then take action as follows.

1

Reload the media, then send the data again.

2

If this does not resolve the problem, then perform alignment manually.

☞ P.97, "Aligning Manually and Cutting"

If the crop marks cannot be detected easily because of the effects of media warping or the like, then perform alignment manually. When you want to perform automatic alignment with lengthy media, we recommend performing output with the data separated into sizes that are as short as possible. With large sizes, error due to warping and the like increases, making smooth detection impossible.

To Quit Detection and Start Cutting

- 1  Press **PAUSE**.
Crop-mark detection stops. Depending on the content of the data, some time may pass before detection actually stops.
- 2 Press **ENTER**.
This stops detection and starts cutting.

Note: After pressing **PAUSE** in step 1, resuming detection or canceling output is also possible.
 ☞ P. 68, "Pausing or Canceling Output"

Aligning Manually and Cutting

Depending on the type of media, it may not be possible to detect crop marks automatically. When crop marks cannot be detected automatically, you perform alignment manually.

Procedure

1. Set the base point.

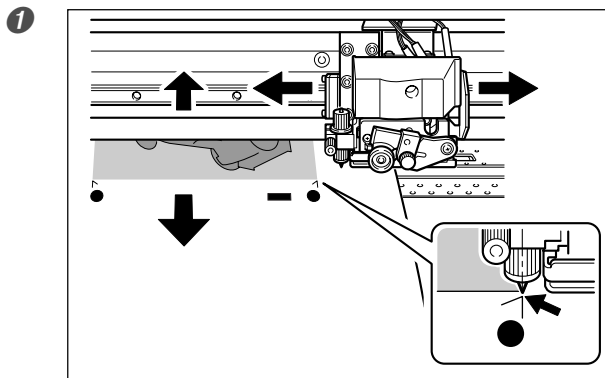

Use **◀ ▶ ▲ ▼** to align the center of the blade with the location shown in the figure.

- 2 

Press **FUNCTION**.
 Press **ENTER**.

2. Set the align points.

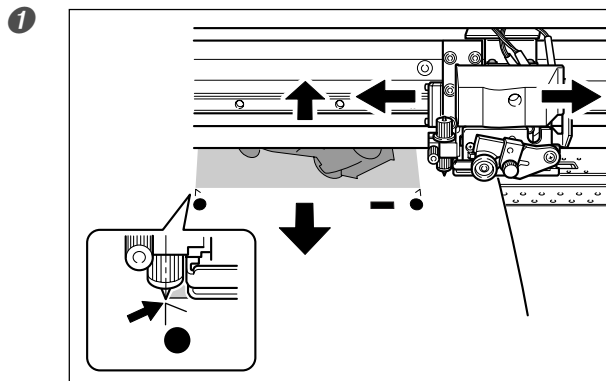

Use to align the center of the blade with the location shown in the figure.

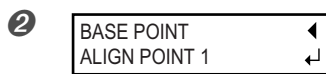

Press .

Press .

The number of the align point you set is automatically determined.

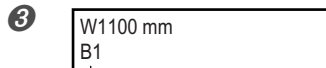

Press .

Press to go back to the original screen.

This indicates that the base point and align point 1 have been set.

4 Repeat steps 1 through 3 to specify other align points as required.

5 Send the cutting data and perform cutting.

About Align Points

The numbers for align points are determined with reference to the location of the base point. You cannot set an align point unless you specify a base point. Redoing the setting for the base point clears any align points that have been set.

Correcting Misalignment for Printing and Cutting When Using Crop Marks

Procedure

1. Check the setting for the [AUTO ENV. MATCH] menu item.

Make sure the [AUTO ENV. MATCH] menu item is set to "ENABLE."

☞ P. 84, "Executing Environment Matching Automatically"

2. Execute the [ADJUST BI-DIR] menu item.

1 Load the media.

☞ P. 32, "Loading Media"







☞ P. 82, "How to Load Sheet Media"

2 Perform bidirectional adjustment.

☞ P. 73, "Correcting for Misalignment in Bidirectional Printing"

☞ P. 74, "Correcting for Misalignment in Bidirectional Printing More Precisely"

3. Print a test pattern and cut it.

- | | |
|---|--|
| <p>1</p> <div style="border: 1px solid black; padding: 2px; width: fit-content;"> MENU ◀▶
 CUTTING MENU ▶ </div> | Press  .
Press  . |
| <p>2</p> <div style="border: 1px solid black; padding: 2px; width: fit-content;"> CUTTING MENU ◀▶
 CROP - CUT ADJ. ▶ </div> | Press  .
Press  . |
| <p>3</p> <div style="border: 1px solid black; padding: 2px; width: fit-content;"> CROP - CUT ADJ. ◀▶
 TEST PRINT ↵ </div> | Press  .
Press  . |

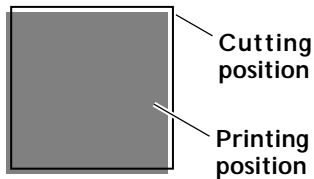

Cutting position and printing position are misaligned.

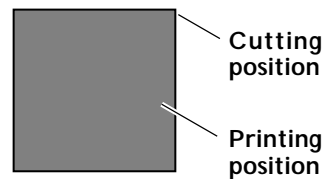

Cutting position and printing position are aligned.

When adjustment is needed, go on to the steps below.

4. Print and cut a test pattern for adjustment.

- | | |
|--|--|
| <div style="border: 1px solid black; padding: 2px; width: fit-content;"> CROP - CUT ADJ. ◀▶
 TEST PRINT 2 ↵ </div> | Press  .
Press  to execute. |
|--|--|

5. From the test pattern, read the correction value at the location.

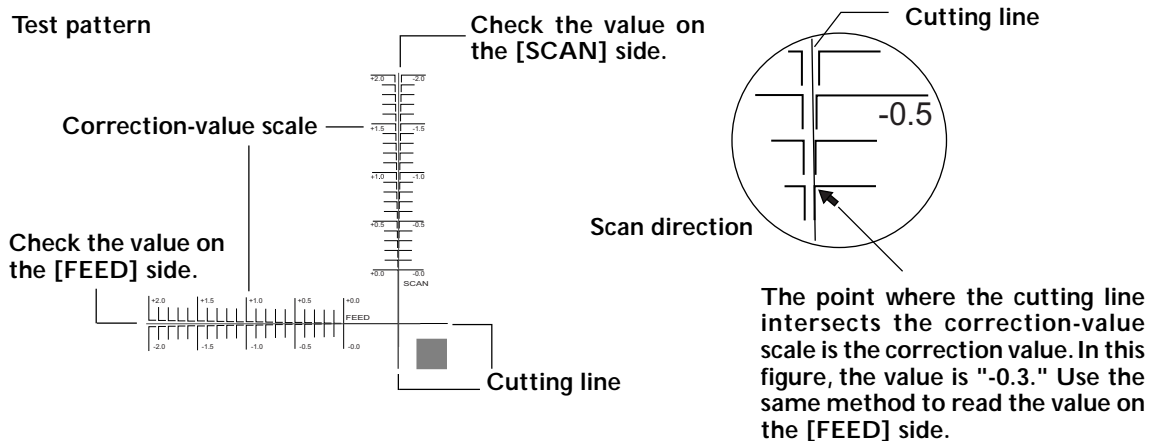

6. Enter the correction value you read.

- 1 Press .
- 2 Press .
Use to set the correction value for [F] (the feed direction).
Use to set the correction value for [S] (the scanning direction).
Press to enable the setting.
- 3 Press .

7. Check the results of adjustment.

-
- Press .
- Press to execute.
- If the printing and cutting lines are aligned, adjustment is complete.
- If further adjustment is needed, go back to step 6. and fine-tune the adjustment.
-
- Cutting position
- Printing position
- Cutting position and printing position are aligned.

Description

Depending on the composition of the media, the positioning of printing and cutting may be misaligned even when you're using crop marks. Make corrections for misaligned printing and cutting for the media you're using.



Default Setting

[F] (feed direction): 0.00 mm
[S] (scanning direction): 0.00 mm

4-10 Making the Network Settings

Setting the IP Address, Subnet Mask, Etc.

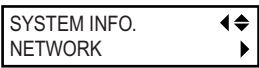
Procedure

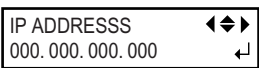
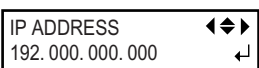
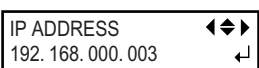
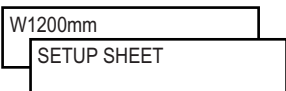
- 1**  Press **MENU**.
Press **▲** several times.
- 2**  Press **▶**.
Press **▲**.
- 3**  Press **▶**.
Use **▲** **▼** to choose the item whose setting you want to make.
- 4**  Press **▶** twice.
Use **▲** **▼** to select the address number.
- 5**  Press **▶**.
- 6**  Repeat **4** and **5** to set all the address numbers.
When you have finished making the setting, press **ENTER**.
- 7**  Press **MENU** to go back to the original screen.

Description

Make sure the machine is connected to the network by an Ethernet cable.
For detailed information about the settings, consult your network administrator.

[IP ADDRESS]: IP address



[SUBNET MASK]: Subnet mask

[GATEWAY ADDR.]: Gateway address

4-11 Viewing Information about the Media and the System

Displaying the Amount of Media Remaining

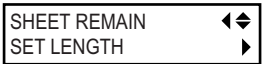
Procedure

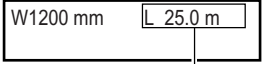
-  Press **MENU**.
Press **▲** twice.
-  Press **▶**.
Press **▼**.
-  Press **▶**.
Use **▲** and **▼** to set the amount of media remaining.
Press **ENTER** to enable the setting.
-  Press **MENU** to go back to the original screen.

This display is updated.



If setup has not been performed, the set value flashes.

Description



You can display how much of the media in use is left. Once you set the amount of media remaining, the amount remaining is displayed at the top menu until it reaches zero. If you cancel the setup such as by removing the media or raising the loading lever, the amount remaining at that time flashes on the screen.

The amount of media remaining is not updated automatically when you change the media. Redo the setting whenever you change the media. You can also make the setting display this menu automatically whenever you change the media. See the next section, "Verifying the Setting for the Amount Remaining Every Time the Media Is Changed."

Note: The remaining amount that is displayed is only an estimate, and its accuracy is not assured.

Verifying the Setting for the Amount Remaining Every Time the Media Is Changed

Procedure

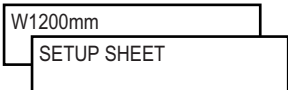
-  Press **MENU**.
Press **▲** twice.
-  Press **▶**.
Press **▼** twice.
-  Press **▶**.
Use **▲** and **▼** to select "ENABLE."
Press **ENTER** to enable the setting.
-  Press **MENU** to go back to the original screen.

Description

Setting this to "ENABLE" automatically displays [SHEET REMAIN] whenever you change the media and finish setup. This makes it impossible to go on to the next operation unless you redo the setting for the amount remaining. This can be useful for keeping you from forgetting to redo the setting when you change the media.

When you set this to "ENABLE," however, be sure also to set the [EDGE DETECTION] menu item to "ENABLE." When [EDGE DETECTION] is set to "DISABLE," then [SHEET REMAIN] is not displayed automatically, regardless of the setting for [AUTO DISPLAY].









☞ P. 78, "Using Transparent Media"

Default Setting

[AUTO DISPLAY]: DISABLE

Printing the Amount of Remaining Media

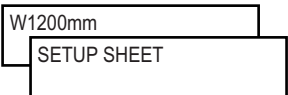
Procedure

- 1  Press .
Press  twice.
- 2  Press .
Press  to perform printing.
- 3  Press  to go back to the original screen.

Description

This prints the amount of media remaining that is displayed at the top menu. You use this when you want to make a record of the remaining length of the media now in use. Printing the amount of media remaining before you change the media enables you to refer to the printed record and use the value to make the setting for the remaining amount the next time you use the media.

Note, however, that continuing by performing the next output starts the output on top of the portion where the amount of remaining media is printed.

After printing the amount remaining, then before you perform the next output operation, we recommend cutting off the media.

☞ P. 38, "Cutting Off the Media"

Viewing the Serial Number, Firmware Version, and Other Information

Procedure

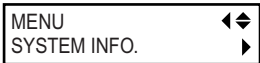
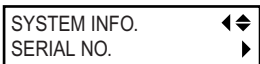
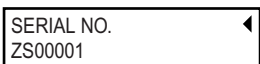
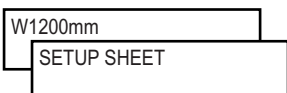
- 1  Press **MENU**.
Press **▲** several times.
- 2  Press **▶**.
Use **▲** **▼** to choose the information you want to view.
- 3  Press **▶**.
- 4  Press **MENU** to go back to the original screen.

Description

You can view the following information.

[MODEL]: Model name

[SERIAL NO.]: Serial number

[INK]: Ink type

[FIRMWARE]: Firmware version

Viewing the Network Settings

Procedure

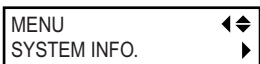
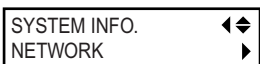
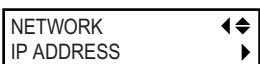
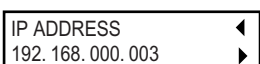
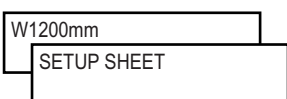
- 1  Press **MENU**.
Press **▲** several times.
- 2  Press **▶**.
Press **▲**.
- 3  Press **▶**.
Use **▲** **▼** to choose the information you want to view.
- 4  Press **▶**.
- 5  Press **MENU** to go back to the original screen.

Description

You can view the following information.

[IP ADDRESS]: IP address



[SUBNET MASK]: Subnet mask

[GATEWAY ADDR.]: Gateway address

[MAC ADDRESS]: MAC address

Printing a System Report

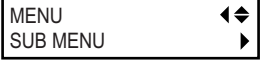
Procedure

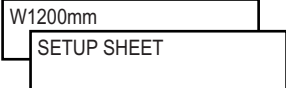
-  Press **MENU**.
Press **▼** several times.
-  Press **▶**.
Press **▲** several times.
Press **ENTER** to start printing.
-  Press **MENU** to go back to the original screen.

Description

This prints system information, including a list of setting values.

4-12 Performing Maintenance

Draining Ink and Performing Internal Washing

Procedure

- | | |
|----------|----|
| MENU | ◀◆ |
| SUB MENU | ▶ |

Press **MENU** .
Press **▼** several times.
- | | |
|-------------|----|
| SUB MENU | ◀◆ |
| INK CONTROL | ▶ |

Press **▶** .
Press **▲** twice.
- | | |
|-------------|----|
| INK CONTROL | ◀◆ |
| HEAD WASH | ↵ |

Press **▶** .
Press **▼** twice.
Press **ENTER** to execute.

Description

This drains the ink inside the printer and washes the interior using cleaning cartridges as a preliminary for moving the printer or conducting maintenance. This operation requires four unused cleaning cartridges. The screen displays information such as instructions to insert and remove cartridges. Follow these instructions to carry out the procedure. After finishing washing, the sub power is automatically switched off.

You do not need to carry this out as part of your daily maintenance activities.

Draining Ink Remaining Inside the Machine

Procedure

- | | |
|----------|----|
| MENU | ◀◆ |
| SUB MENU | ▶ |

Press **MENU** .
Press **▼** several times.
- | | |
|-------------|----|
| SUB MENU | ◀◆ |
| INK CONTROL | ▶ |

Press **▶** .
Press **▲** twice.
- | | |
|-------------|----|
| INK CONTROL | ◀◆ |
| PUMP UP | ↵ |

Press **▶** .
Press **▼** .
Press **ENTER** to execute.

Description

This removes ink inside the printer as a preliminary procedure for performing maintenance. The screen displays information such as instructions to insert and remove cartridges. Follow these instructions to carry out the procedure. After finishing the procedure, the sub power is automatically switched off.

You do not need to carry this out as part of your daily maintenance activities.

4-13 Menu List

Main Menu

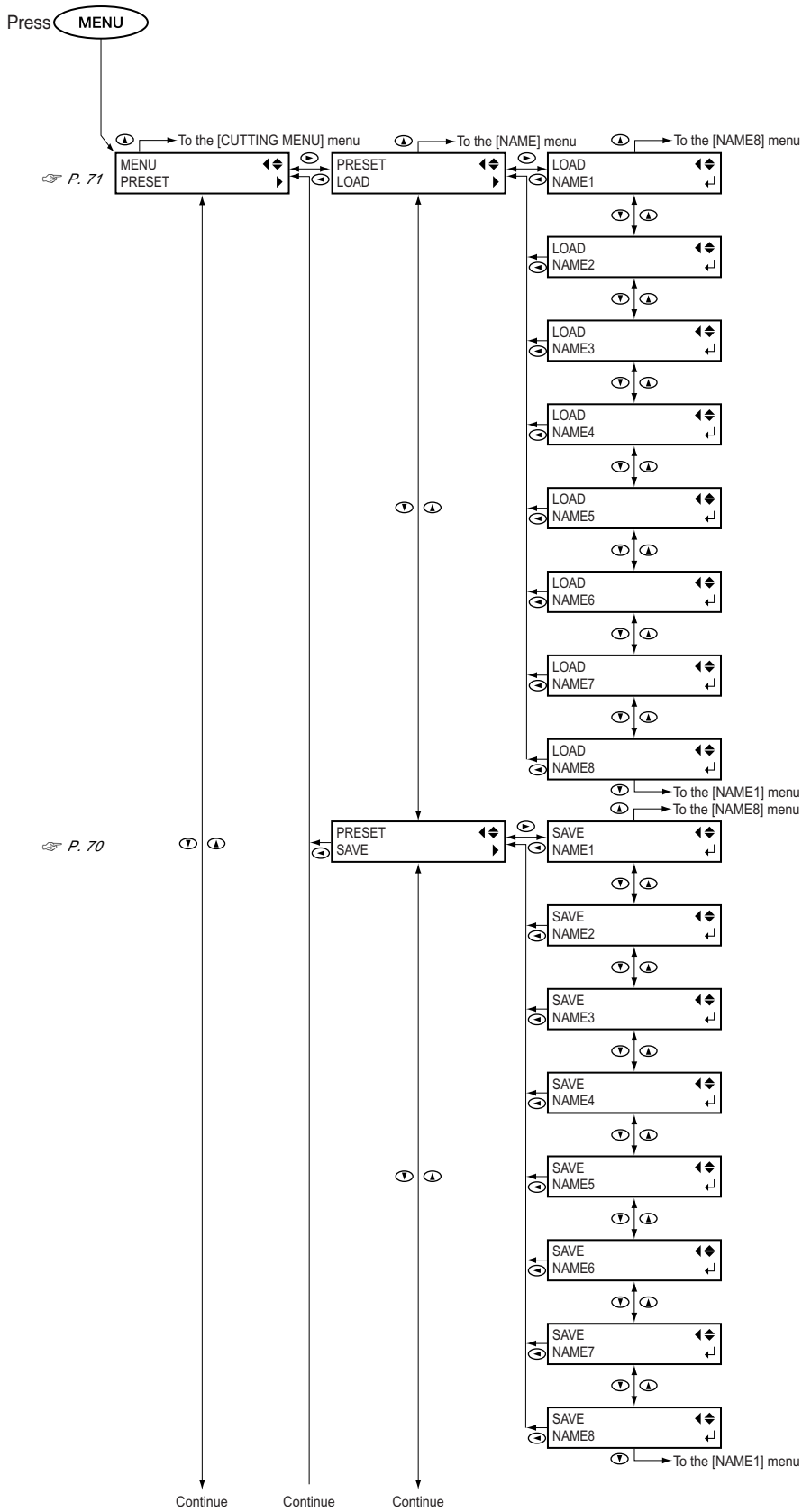

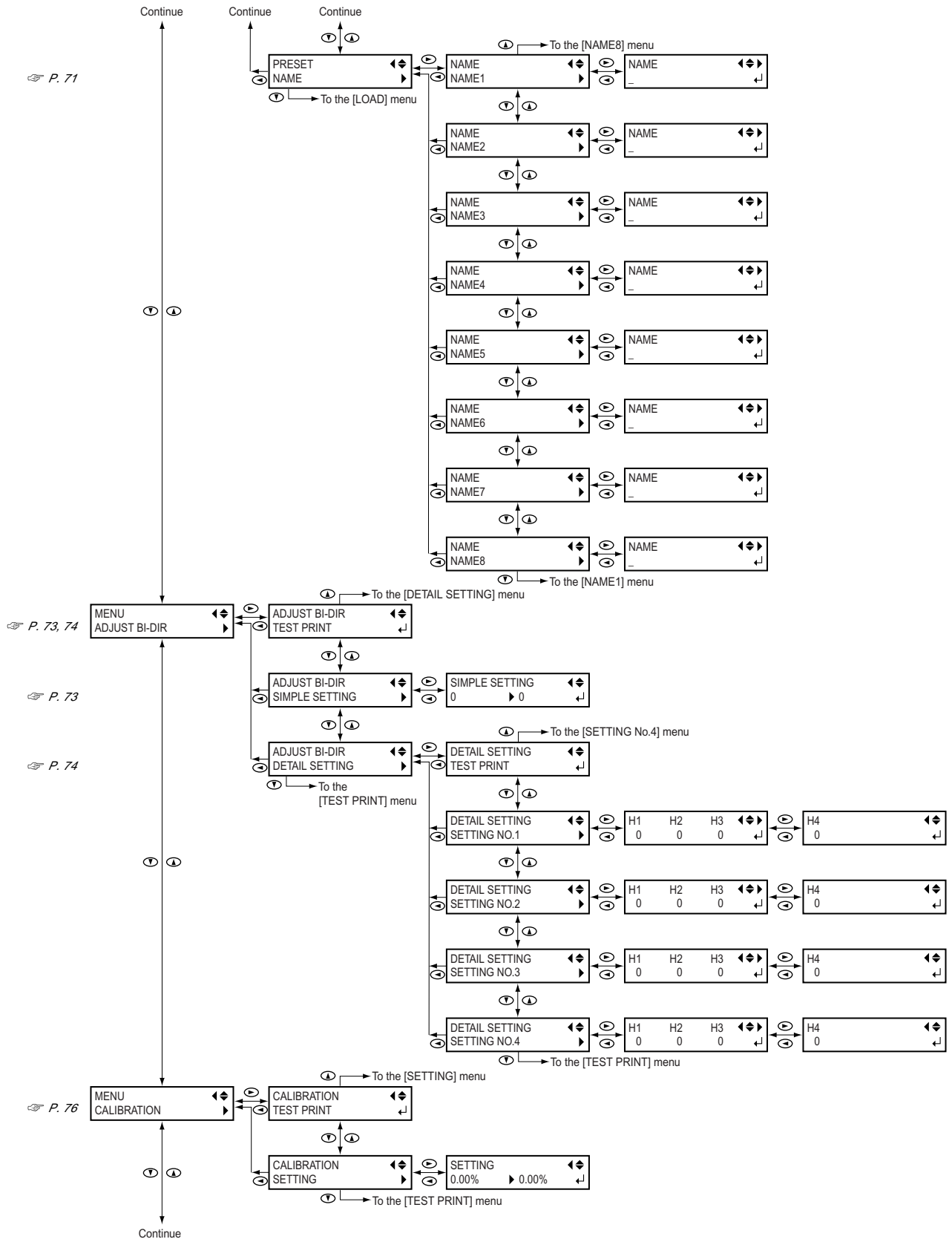

4-13 Menu List

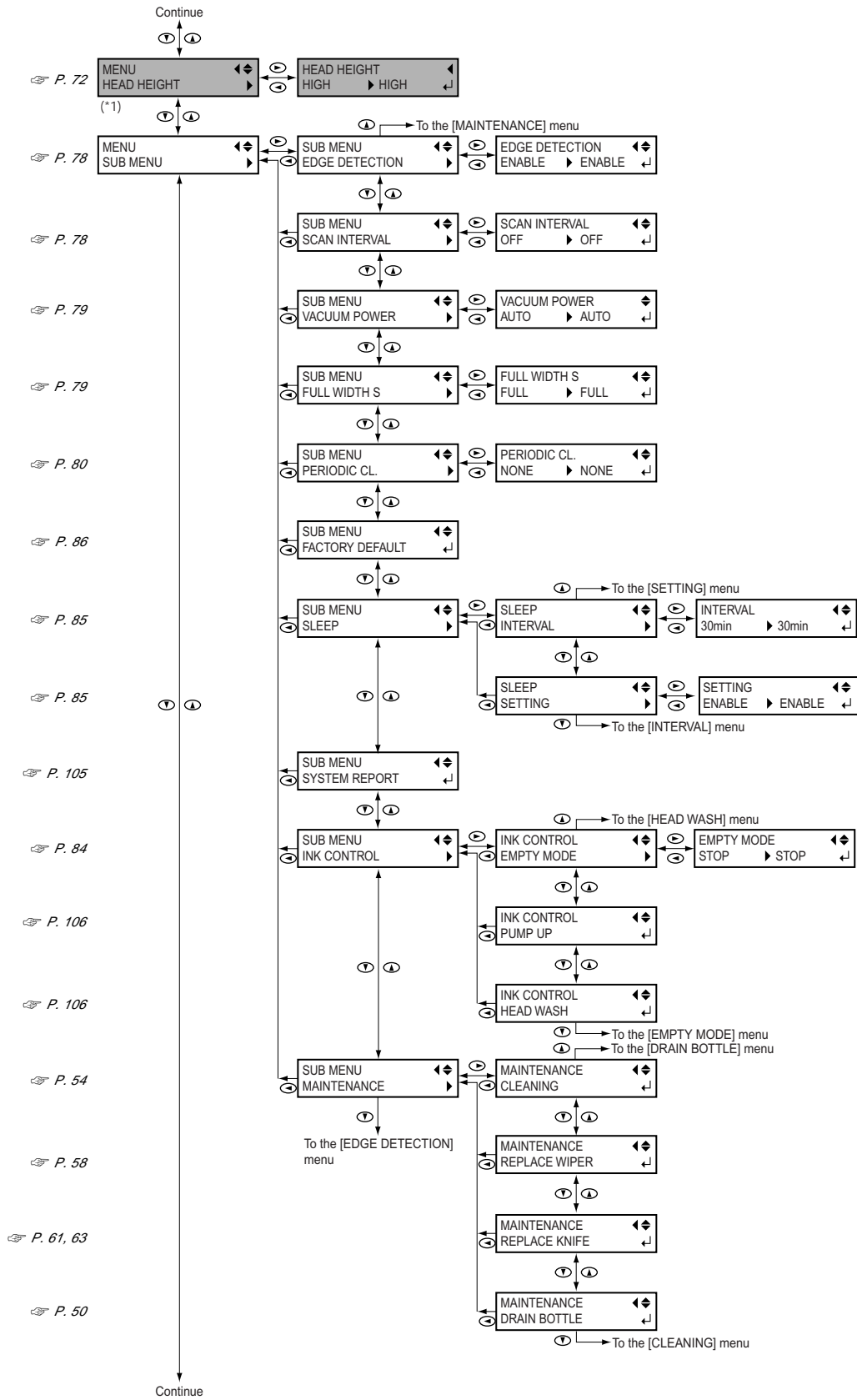

(*1) This is displayed only on the 54-inch model.

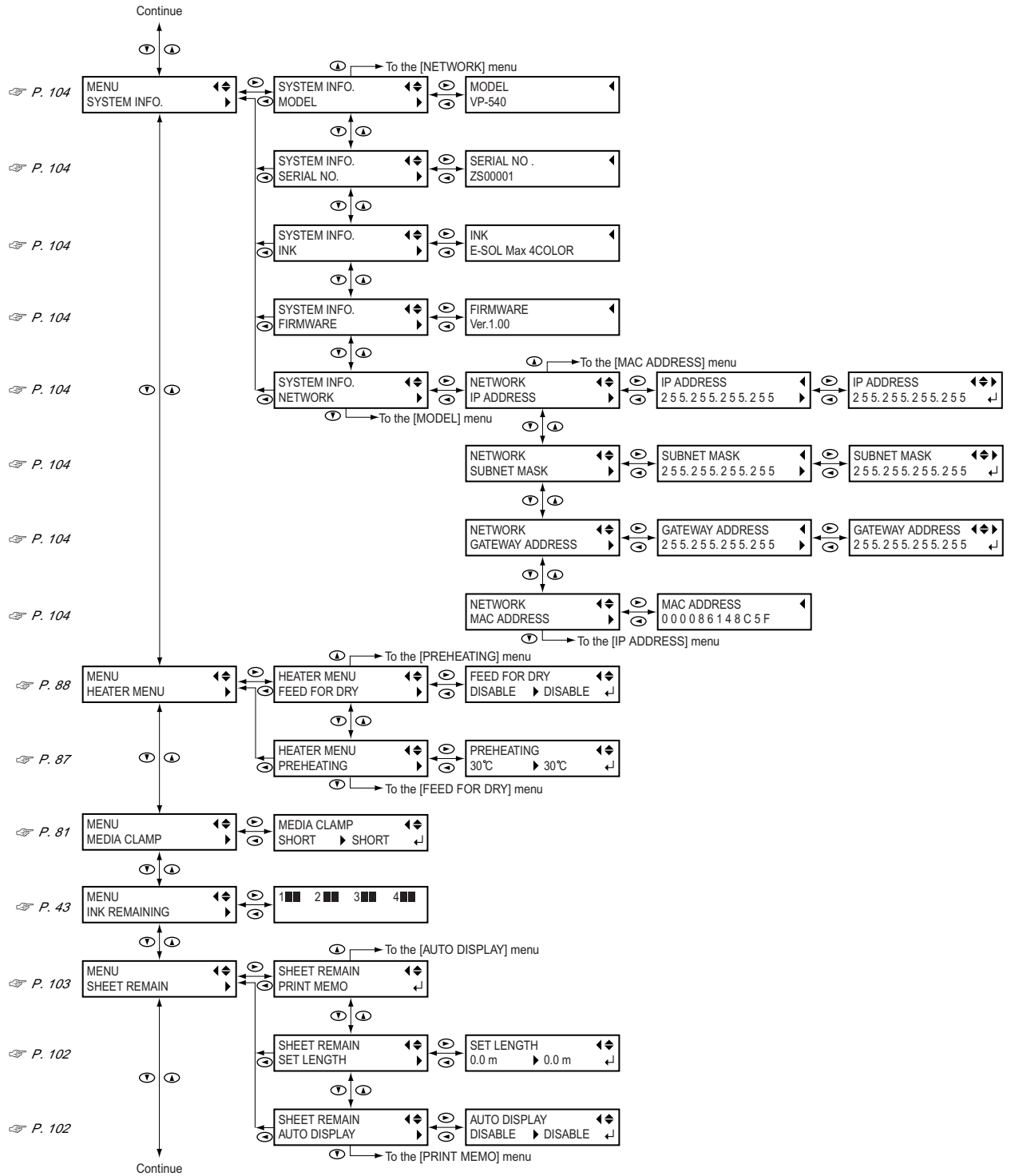

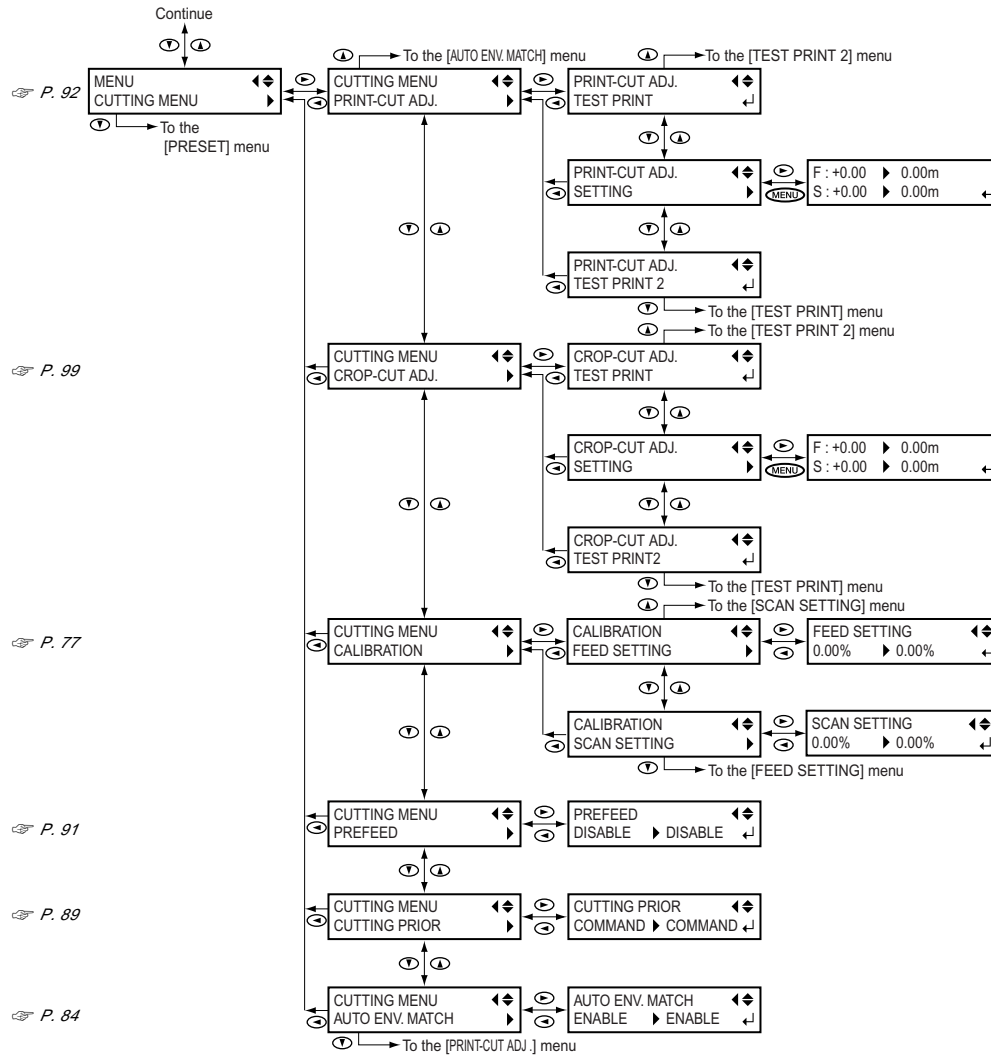

Language and Unit Menu

While holding down **MENU**, switch on the sub power.

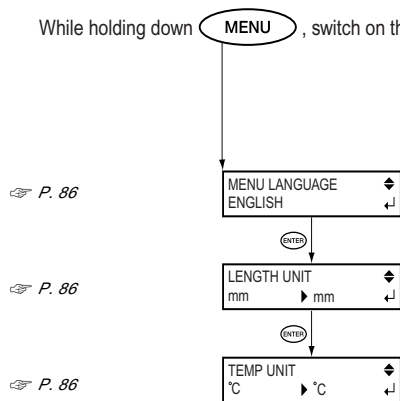

Function Menu

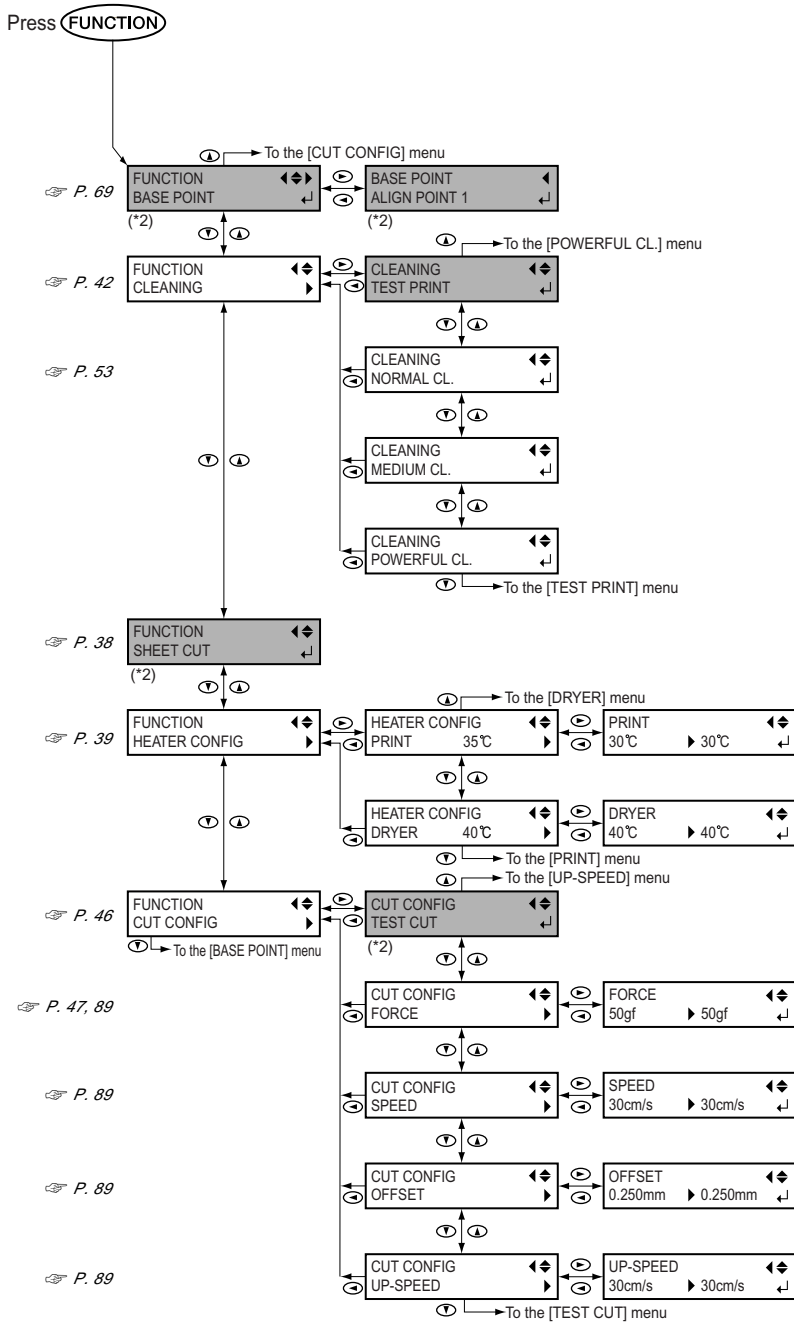

(*2) This is not displayed when no media is loaded (that is, when **SETUP** is dark).

Chapter 5

What to Do If

5-1 The Machine Doesn't Run

The Printer Unit Doesn't Run

Is the power switched on?

Switch on the printer's main power, then press the sub power switch and make sure the sub power switch lights up.

Is **SETUP** illuminated?

Output is not performed when **SETUP** is not illuminated. Lower the loading lever.

Is the front cover open?

Close the front cover.

Is the top menu displayed?

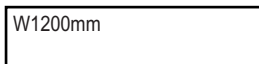

Top menu

If the top menu isn't displayed, output doesn't start even when data is sent from the computer. To go to the top menu, press **MENU**, then press **◀**.

☞ P. 41, "Getting Ready to Receive Data from a Computer"

Is **PAUSE** illuminated?

When **PAUSE** lights up, operation is paused. To resume, press **PAUSE**. **PAUSE** goes dark and outputting resumes.

Has ink run out?



When printing data is sent while the screen shown in the figure is displayed, a message appears

and a warning beep sounds. At the same time, operation pauses. When the ink cartridge is replaced with a new one, printing or cutting starts.

☞ P. 44, "If Ink Runs Out"

☞ P. 84, "Determining What Happens When Ink Runs Out"

Is a message displayed on the screen?

☞ P. 122, "If a Message Appears"

☞ P. 123, "If an Error Message Appears"

Is the cable connected?

Connect the cable securely.

Is the Link LED lighted?

If the Link LED for the Ethernet connector is not lighted, it means that a correct connection to the network has not been made. Make sure the network routing is suitable. Try connecting the computer and the machine to the same hub, or connecting them directly using a crossover cable. If this makes it possible to perform output, it means the problem is in the network itself.

Are the network settings correct?

If output is not possible even though the Link LED is lighted, check to make sure the IP address and other such settings are correct. The settings on both the machine and the computer must be appropriate. Redo the settings, checking to ensure that the IP address doesn't conflict with the IP ad-

dress for another device on the network, that the port setting for the software RIP specifies the IP address set on the machine, that the settings have no typing errors, and for other such problems.

☞ Setup Guide

☞ P. 104, "Viewing the Network Settings"

Did the software RIP end abnormally?

Make sure the software RIP is running correctly, then switch the sub power switch off and back on.

The Media Heating System Doesn't Warm Up

Is media loaded?

The media heating system does not warm up to the preset temperature when **SETUP** is dark (by default). Load media and wait for the machine to warm up.

☞ P. 87, "Determining How the Media Heating System Operates"

Is the temperature of the room too low?

Use the machine in an environment where the temperature is 20 to 32°C (68 to 90°F).

5-2 Attractive Printing or Cutting Is Impossible

Printed Results Are Coarse or Contain Horizontal Stripes

Do the print heads show dot drop-out?

Carry out a printing test and make sure no dot drop-out occurs. If dot drop-out is present, perform head cleaning.

☞ P. 42, "Printing Tests and Cleaning"

☞ P. 53, "When Head Cleaning Is Not Effective"

Is the head height appropriate?

Printing when the [HEAD HEIGHT] menu item is set to "HIGH" is coarser than when set to "LOW." Keep this set to "LOW" except when changing it is necessary, such as when you're using thick media.

☞ P. 72, "Adjusting Head Height to Match Media Thickness (54-inch Model Only)"

Have you carried out feed correction?

Large misalignment in the amount of feed of the media may result in printing that seems coarse or contains horizontal stripes. Either make the setting on the computer to match the type of media you're using, or make the setting for correction on the printer.

☞ P. 76, "Performing Feed Correction to Alleviate Horizontal Bands and the Like"

Have you carried out bidirectional correction?

When you are performing bidirectional printing, use the [ADJUST BI-DIR] menu item to carry out correction. The optimal adjustment value may vary, depending mainly on the thickness of the media. Set or select an adjustment value that is suited to the media.

☞ P. 73, "Correcting for Misalignment in Bidirectional Printing"

☞ P. 74, "Correcting for Misalignment in Bidirectional Printing More Precisely"

Is the print heater at a suitable temperature?

If the ink forms lumps or smudges, raise the temperature. Note, however, that a temperature that is too high may degrade the media or cause it to wrinkle.

☞ P. 39, "Settings for the Media Heating System"

Is the temperature of the room too low?

The media heating system may not warm up sufficiently when the ambient temperature is less than 20°C (68°F). Also, even when the media heating system reaches its preset temperatures, adequate effectiveness may not be apparent if the media is thoroughly chilled. Before printing, allow the media to come to room temperature.

Is the print mode suitable?

If attractive printing is impossible even when the media heating system is at a high temperature, try using a higher-quality print mode.

Depending on the media, smudging may occur when using a high-quality print mode, and results may also vary greatly depending on the settings of your software RIP (such as the

color-profile selection). Make settings suited to the media you're using.

Is the printer installed in a level and stable location?

Never install the machine in a location where it is tilted or where it may wobble or experience vibration. Also make sure that the print heads are not exposed to moving air. These factors may lead to missing dots or reduced printing quality.

Is the media loaded and set up correctly?

If the media is not loaded and set up correctly, media feed may not be smooth, or printing may be adversely affected. Make sure the media is loaded and set up correctly.

☞ P. 120, "Media Wrinkles or Shrinks, or Feed Is Unstable"

Are the settings for the [PRESET] menu item appropriate?

If the settings selected with the [PRESET] menu item are not suitable for the type of media, printing may be adversely affected. Choose settings optimized to the media you're using.

☞ P. 70, "Saving Optimized Media Settings As Preset Values"

☞ P. 71, "Loading a Saved Preset"

Colors Are Unstable or Uneven

Did you shake the ink cartridges gently before installing them?

If you're using a model that uses ECO-SOL MAX ink, then shake new cartridges gently before you install them.

Is the media wrinkled?

If the media is wrinkled and comes loose from the platen, colors may be uneven or printing quality may suffer.

☞ P. 120, "Media Wrinkles or Shrinks, or Feed Is Unstable"

Was printing paused partway through?

When printing is paused, the coloring at the seam may be altered when printing resumes. Avoid pausing printing. By default, printing pauses when ink remaining inside the machine runs out. Before you perform lengthy printing, check the amount of ink remaining in the ink cartridges.

Printing may also pause when data is not sent from the computer quickly enough. We recommend not performing any other tasks with the computer while printing is in progress.

Is the printer installed in a level and stable location?

Never install the machine in a location where it is tilted or where it may wobble or experience vibration. Also make sure that the print heads are not exposed to moving air. These factors may lead to missing dots or reduced printing quality.

Are the operating parameters set to appropriate values?

Depending on the settings for such menu items as [FULL WIDTH S] and [PERIODIC CL.], uneven colors may occur. If the settings have been changed, try restoring them to their default values.

- ☞ P. 79, "Speeding Up Output for Narrow Media"
- ☞ P. 80, "Preventing Soiling of the Media and Dot Drop-out During Printing"

Are the settings for the [PRESET] menu item appropriate?

If the settings selected with the [PRESET] menu item are not suitable for the type of media, printing may be adversely affected. Choose settings optimized to the media you're using.

- ☞ P. 70, "Saving Optimized Media Settings As Preset Values"
- ☞ P. 71, "Loading a Saved Preset"

The Media Becomes Soiled When Printed

Do the print heads contact the media?

The height of the print heads may be too low. Also, if the media is not loaded and set up correctly, it may wrinkle or come loose and strike the heads.

- ☞ P. 120, "Media Wrinkles or Shrinks, or Feed Is Unstable"
- ☞ P. 72, "Adjusting Head Height to Match Media Thickness (54-inch Model Only)"

Are the print heads dirty?

The following may cause ink to drip on the media during printing.

- Buildup of fibrous dust (lint) around the heads.
- Ink transferred to the heads due to rubbing against the media.

If this happens, clean the heads using the cleaning kit. We recommend carrying out periodic head cleaning.

- ☞ P. 54, "Cleaning the Heads Using the Cleaning Kit"

Are the pinch rollers or the media clamps dirty?

Periodically clean them.

- ☞ P. 52, "Cleaning"

Cutting Is Misaligned or Skewed

Is the media loaded and set up correctly?

If the media is not loaded and set up correctly, or media feed is not smooth, cutting may be adversely affected. Make sure the media is loaded and set up correctly.

- ☞ P. 120, "Media Wrinkles or Shrinks, or Feed Is Unstable"

Are the settings for the cutting conditions appropriate?

Misalignment or skewing may occur if the cutting speed is too fast or the blade force is too high. Try changing the cutting conditions. With media having a strong adhesive

layer, the adhesive layer reattaches to itself immediately after cutting. However, if a cutting test shows that the peeling of the media and the blade traces on the backing paper are optimal, then the media is being cut properly. Be careful not to make the blade force too high.

Is the length of output too long?

For printing followed immediately by cutting in particular, the longer the page length (that is, the longer the distance the media is returned after printing), the greater is the chance of misalignment occurring. It is a good idea to keep the size of each single page to the minimum necessary.

Are you using media that exhibits large expansion and contraction?

When you're performing printing followed immediately by cutting, misalignment occurs if the media expands or contracts. If this happens, try performing printing with crop marks, then setting the base point and one or more align points and performing cutting. This corrects for expansion and contraction of the media.

Is [AUTO ENV. MATCH] set to the "DISABLE" setting?

The printing and cutting positions may become misaligned due to ambient temperature or humidity. Setting [AUTO ENV. MATCH] to "ENABLE" performs matching to the environment to correct for misalignment.

- ☞ P. 84, "Executing Environment Matching Automatically"

Are the settings for the [CALIBRATION] menu item (in the [CUTTING MENU] menu item) correct?

When you're performing printing followed immediately by cutting, go to [CUTTING MENU] and set the [CALIBRATION] value to "0.00."

- ☞ P. 77, "Performing Distance Correction During Cutting"

5-3 The Media Jams

The Media Jams

If an error message is displayed because the media has jammed, immediately correct the problem. Failure to do so may damage the print heads.

☞ P. 123, [MOTOR ERROR TURN POWER OFF]

Is the media warped or wrinkled?

Many factors can cause warping or wrinkling. Refer to the following and correct the problem.

☞ P. 120, "Media Wrinkles or Shrinks, or Feed Is Unstable"

Is the height of the print heads too low?

Try raising the heads higher. Media may inevitably warp or wrinkle slightly, so adjust the height of the heads to take this into account.

☞ P. 72, "Adjusting Head Height to Match Media Thickness (54-inch Model Only)"

5-4 Media Wrinkles or Shrinks, or Feed Is Unstable

A variety of problems can occur if the media feed is not smooth. This can cause such problems as poor printing quality, contact with the media by the print heads, misaligned positioning, or media jams. Take action as follows.

Media Wrinkles or Shrinks

Is the media loaded and set up straight and securely?

Feed is not smooth when the media is not straight or is tensioned unevenly on the left and right. Reload the media.

Was loaded media allowed to stand for some time?

Media may shrink or wrinkle if it is heated for an extended time. When printing ends, switch off the sub power or remove the media.

Are the media clamps mounted?

When you're performing printing, be sure to attach the media clamps.

Was the media loaded while the print heater was hot?

Loading media after the print heater has warmed up causes the temperature of the media to rise suddenly, which may cause the media to shrink or wrinkle during printing. Before loading media, switch off the sub power and allow the platen to cool.

Is the temperature of the media heating system too high?

Set the temperature to suitable values for the type of media.
☞ P. 39, "Settings for the Media Heating System"

Is the temperature of room too low?

Use this machine in an environment having an ambient temperature of 20 to 32°C (68 to 90°F). If the machine is used at an ambient temperature less than 20°C, then depending on the type or width of the media, wrinkling or temperature-caused unevenness may occur. If this happens, try lowering the temperature of the media heating system by about 2°C.

To obtain stable printing results, however, the machine should be used at an ambient temperature of 20 to 32°C (68 to 90°F).

Media Feed Is Not Straight

Is the media loaded and set up straight and securely?

Feed is not smooth when the media is not straight or is tensioned unevenly on the left and right. Reload the media.

Media Feed Is Not Smooth

Do the media or the shafts strike some other object?

Make sure the media and the shafts do not touch anything else. This may affect output, even when feed appears to be smooth.

Is the media too thick?

Media that is too thick may not only cause unstable feed, but may scrape the print heads, resulting in malfunction. Never use such media.

Are the grit rollers dirty?

Check to make sure the grit rollers are free of buildup of foreign material such as media scraps.

5-5 The Print Heads Stopped Moving

If the print-head carriage stops over the platen, take action immediately to prevent the heads from drying out.

What to Do First

Switch the sub power off, then back on again. (If the media is jammed, then also remove the media.) If the print-head carriage move to the standby position (inside the side cover), it means the operation has ended successfully.

If the print-head carriage did not move, try switching off the main power, then again switching on the main power, followed by the sub power.

If the Heads Still Do Not Move

If the heads still do not move, carry out the following emergency response measure, then contact your authorized Roland DG Corp. dealer.

1. Switch off the main power and open the front cover.
2. Detach the side cover.
3. Gently move the print heads to the standby position.
4. Stopping at the place where the audible click is heard locks the print heads in place.

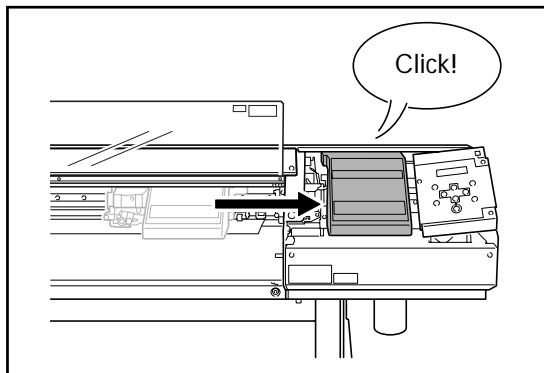

5. Gently apply pressure from the right side to make sure the heads don't move to the left.

If the print heads move to the left, again move them slowly by applying pressure to the left side and make sure they lock in place.

5-6 If a Message Appears

These are the main messages that appear on the machine's display to prompt correct operation. They do not indicate any error. Follow the prompts and take action accordingly.

[1n 2n 3n 4n]

Only a small amount of ink remains. Replace the cartridge indicated by the flashing number with a new cartridge.

[PRESS THE POWER KEY TO CLEAN]

If you're using ECO-SOL MAX ink, this appears when the machine has been unused for about one month.

Switch on the sub power once a month.

☞ P. 65, "When Not in Use for a Prolonged Period"

[CLOSE THE COVER (FRONT COVER, SIDE COVER or MAINTENANCE COVER)]

Close the front cover, side cover, or maintenance cover. For safety, the carriage does not operate while a cover is open.

[SHEET NOT LOADED SETUP SHEET]

Load media. This message appears when an attempt to perform a printing test was made while no media was loaded.

[CHECK DRAIN BOTTLE]

This appears when a certain amount of discharged fluid collects in the drain bottle. To clear the message, press **ENTER**. If this screen appears, go to the [DRAIN BOTTLE] menu and discard the discharged fluid in the bottle.

☞ P. 50, "Disposing of Discharged Ink"

[INSTALL DRAIN BOTTLE]

Check whether the drain bottle is installed. Install the drain bottle, then press **ENTER**.

[NOW HEATING...]

Wait until the media heating system reaches the preset temperature. Printing starts when **HEATER** lights up.

You can stop printing by holding down **PAUSE** for one second or longer while this is displayed. Pressing **PAUSE** makes printing start immediately, without waiting to reach the preset temperature.

[TIME FOR MAINTENANCE]

It is time to clean the heads using the cleaning kit. After verifying, press **ENTER**.

☞ P. 54, "Cleaning the Heads Using the Cleaning Kit"

[TIME FOR WIPER REPLACE]

It is time to replace the wipers. After verifying, press **ENTER**.

☞ P. 58, "Replacing the Wipers"

5-7 If an Error Message Appears

This describes the error messages that may appear on the machine's display, and how to take action to remedy the problem. If the action described here does not correct the problem, or if an error message not described here appears, contact your authorized Roland DG Corp. dealer.

[ALIGN POINT POSITION INVALID]

An attempt was made to set an align point at a location where the setting cannot be made.

No align point can be set when the angle of the base point and the align point is too large.

Reload the media correctly, so that the angle is minimized, then set the base point and the align point again to match the crop marks.

☞ P. 96, "Aligning Automatically and Cutting"

[AVOIDING DRY-UP TURN POWER OFF]

The print heads were forced to standby position to prevent them from drying out.

Operation cannot be continued. Switch the sub power off, then back on.

[CAN'T PRINT CROP CONTINUE?]

The size of the data including the crop marks is larger than the printing or cutting area of the loaded media.

To continue performing output without correcting this, press **ENTER**. At this time, the portion extending beyond the printing or cutting area and the crop marks are not printed. To stop output, stop sending data from the computer, then raise the loading lever. Make the printing or cutting area wider, such as by replacing the media with a larger piece of media or by changing the positions of the pinch rollers, then send the data again.

The size of the data being output is too small.

Make the scanning-direction size of the data at least 65 mm (2.6 in).

To continue performing output without correcting this, press **ENTER**. At this time, the data is output without printing the crop marks. To stop output, stop sending data from the computer, then raise the loading lever. Change the size of the data, then send the data again. There is no limitation in the size of the data in the media-feed direction.

[CARRIAGES ARE SEPARATED]

The cutting carriage and the print-head carriage were improperly disconnected.

A problem such as a media jam occurred, impeding correct operation. Operation cannot be continued. Switch the sub power off, then back on.

[CROPMARK ERROR NOT FOUND]

Automatic detection of crop marks could not be accomplished.

Load the media at the correct position and perform detection of crop marks again. Depending on the media, it may not be possible to detect crop marks automatically. If repeating automatic crop-mark detection results in an error again, then perform manual crop-mark detection.

☞ P. 97, "Aligning Manually and Cutting"

[DATA ERROR CANCELING...]

Output was stopped because a problem was found in the data received.

Operation cannot be continued. Check for a problem with the connector cable or the computer, and redo the operation from the step of loading the media.

[HEATING TIMEOUT CONTINUE?]

The print heater or dryer did not reach the preset temperature.

This occurs because the temperature of the location where the machine is installed is too low. We recommend raising the temperature. To continue waiting for the temperature to rise, press **ENTER**. To start printing immediately, press **PAUSE**.

[LONG MEDIA CLAMP IS INSTALLED]

Media cutoff was attempted even though [MEDIA CLAMP] is set to "LONG."

To prevent malfunction or damage to the machine, media-cutoff operations are not performed when [MEDIA CLAMP] is set to "LONG." Use **ENTER** to go back to the original screen, then either detach the media clamps, or replace them with short media clamps and set [MEDIA CLAMP] to "SHORT."

☞ P. 38, "Cutting Off the Media"

[MOTOR ERROR TURN POWER OFF]

A motor error occurred.

Operation cannot be continued. Switch off the sub power. Next, eliminate the cause of the error, then immediately switch on the sub power. If the machine is allowed to stand with the error uncorrected, the print heads may dry out and become damaged.

This error may be caused by such factors as a mistake in loading the media, a media jam, or an operation that pulls the media with excessive force.

The media has jammed.

Carefully remove the jammed media. The print heads may also be damaged. Perform head cleaning, then perform a printing test and check the results.

The media was pulled with excessive force.

Excessive tension was applied to the media, and additional action is necessary to recover from this state. First, move the loading lever to the rear and adjust the media to create a small amount of slack, then switch on the sub power.

[PINCHROLL ERROR INVALID RIGHT POS]

The right pinch roller is positioned at a location where it does not pinch the media.

Raise the loading lever and move the right pinch roller to the correct location.

☞ P. 32, "Loading and Cutting Off Media"

[PINCHROLL ERROR INVALID LEFT POS]

The left pinch roller is positioned at a location where it does not pinch the media.

Raise the loading lever and move the left pinch roller to the correct location.

☞ P. 32, "Loading and Cutting Off Media"

[PINCHROLL ERROR XXX FROM RIGHT]

The middle pinch rollers are positioned at locations where they do not pinch the media.

Raise the loading lever and move the middle pinch rollers to the correct location.

☞ P. 32, "Loading and Cutting Off Media"

Too many middle pinch rollers are installed.

Raise the loading lever, then remove all middle pinch rollers that are not positioned above grit rollers. The number of middle pinch rollers used varies according to the width of the loaded media.

☞ P. 32, "Loading and Cutting Off Media"

[SERVICE CALL xxxx]

An unrecoverable error occurred, or part replacement that must be performed by a service technician is required.

Note the number displayed, then switch off the sub power. After you switch off the power, inform your authorized Roland DG Corp. dealer of the number that appeared on the display.

[SHEET TOO SMALL CONTINUE?]

The size of the data is larger than the printing or cutting area of the loaded media.

To continue performing output without correcting this, press **ENTER**. At this time, the portion extending beyond the printing or cutting area is not output. To stop output, stop sending data from the computer, then raise the loading lever. Make the printing or cutting area wider, such as by replacing the media with a larger piece of media or by

changing the positions of the pinch rollers, then send the data again.

[SHEET SET ERROR SET AGAIN]

The loading lever was lowered while no media was loaded.

Raise the loading lever, place media at the correct location, then lower the lever again.

☞ P. 32, "Loading and Cutting Off Media"

[EDGE DETECTION] is set to "ENABLE," but transparent media was loaded.

Raise the loading lever, set the [EDGE DETECTION] menu item to "DISABLE," then reload the media.

☞ P. 78, "Using Transparent Media"

The loaded media is too small.

Press any key to clear the error. Replace with media of usable size.

[TEMPERATURE IS TOO HIGH **°C]

The temperature of the location where the machine is installed has risen above the ambient temperature at which the machine can operate.

Operation cannot be continued. Switch off the sub power. The displayed temperature is the current ambient temperature of the installation location. Bring the installed location to a temperature at which operation is possible (15 to 32°C) and allow the machine to come to room temperature, then turn on the power.

[TEMPERATURE IS TOO LOW **°C]

The temperature of the location where the machine is installed has fallen below the ambient temperature at which the machine can operate.

Operation cannot be continued. Switch off the sub power. The displayed temperature is the current ambient temperature of the installation location. Bring the installed location to a temperature at which operation is possible (15 to 32°C) and allow the machine to come to room temperature, then turn on the power.

[SET HEAD HEIGHT TO xxx] (54-inch model only)

The height of the print heads is lower than the height specified on the computer.

This warning indicates that the height of the print heads is too low for the media thickness specified on the computer. The heads move to a location where you can operate the height-adjustment lever. Adjust to the displayed height, then press **ENTER**.

☞ P. 72, "Adjusting Head Height to Match Media Thickness (54-inch Model Only)"

[WRONG CARTRIDGE]

A cartridge that cannot be used was installed.

Remove the cartridge to clear the error. Use a cartridge of the specified type.

Chapter 6

Specifications

6-1 Usable Media

Conditions for Usable Media

Media width

54-inch model
8.3 to 54 inches (210 to 1,371 mm)
30-inch model
7.2 to 30 inches (182 to 762 mm)

A) Cuttable media thickness

0.08 to 0.22 mm (3.2 to 8.6 mil)
(depending on media composition)

B) Maximum media thickness (including backing paper)

Printing only: 1.0 mm (39 mil)
When performing cutting: 0.4 mm (15 mil)

C) Roll outer diameter

180 mm (7 in.)

D) Paper tube (core) inner diameter

50.8 mm or 76.2 mm (2 inches or 3 inches)

Roll weight

54-inch model
30 kg (66 lb.)
30-inch model
20 kg (44 lb.)

Other conditions

Media such as the following cannot be used.

- > Media having an inward curl (i.e., media whose print surface is on the inner side of the roll)
- > Media whose end is attached to the paper tube (core)
- > Media which is severely warped or which has a strong tendency to reroll
- > Media that cannot withstand the heat of the media heating system
- > Media whose paper tube (core) is bent or crushed
- > Media that bends under its own weight when loaded

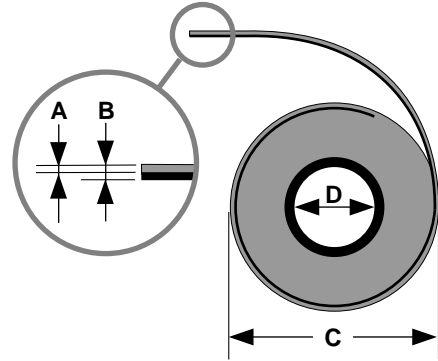

This machine cannot necessarily print every kind of media. When selecting media, be sure to carry out testing in advance to make sure that satisfactory printing quality is obtained.

6-2 Printing/Cutting Area

Maximum Area

The printing or cutting area along the horizontal plane (the direction in which the carriages move) is determined by the position of the pinch rollers.

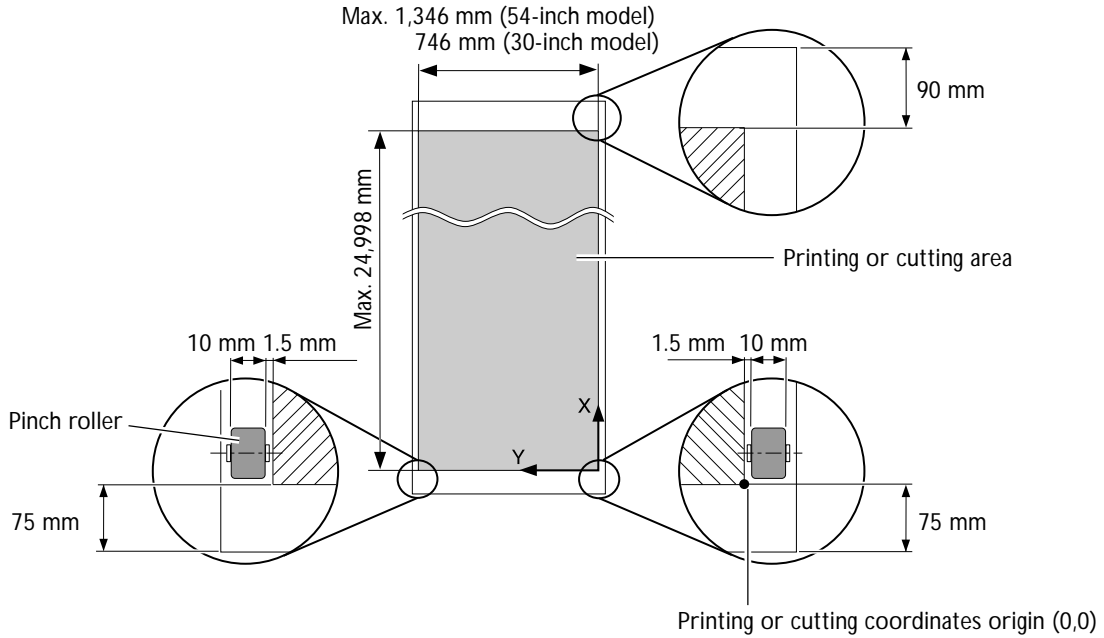

Maximum Area When Using Crop Marks

When crop marks are used, the printing or cutting area is reduced from the maximum area by an amount equal to the crop marks.

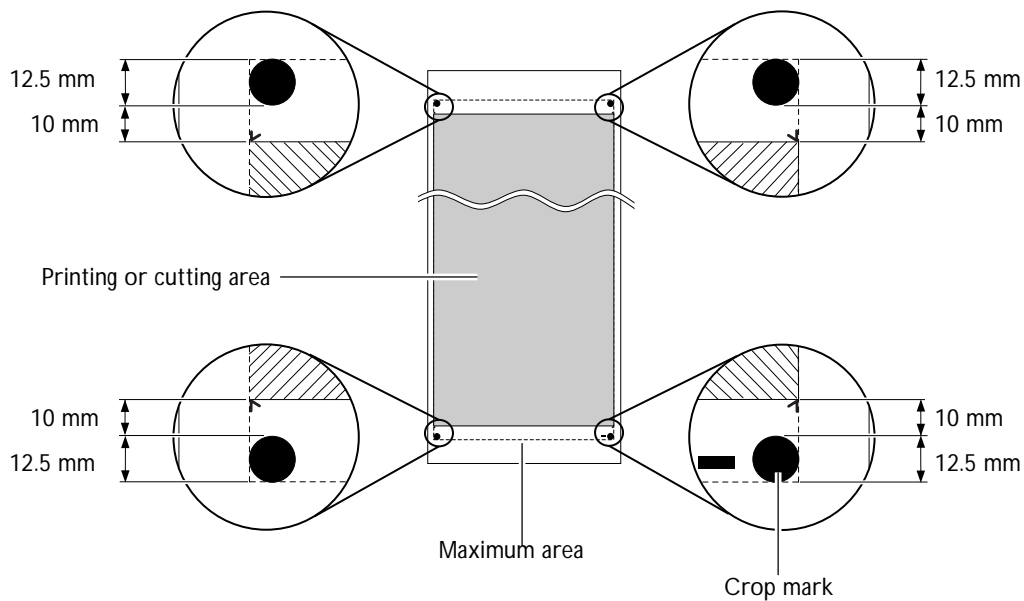

The Media-cutoff Location During Continuous Printing

When a media-cutoff command is sent from the computer, the cutoff location on the media is as shown in the figure below.

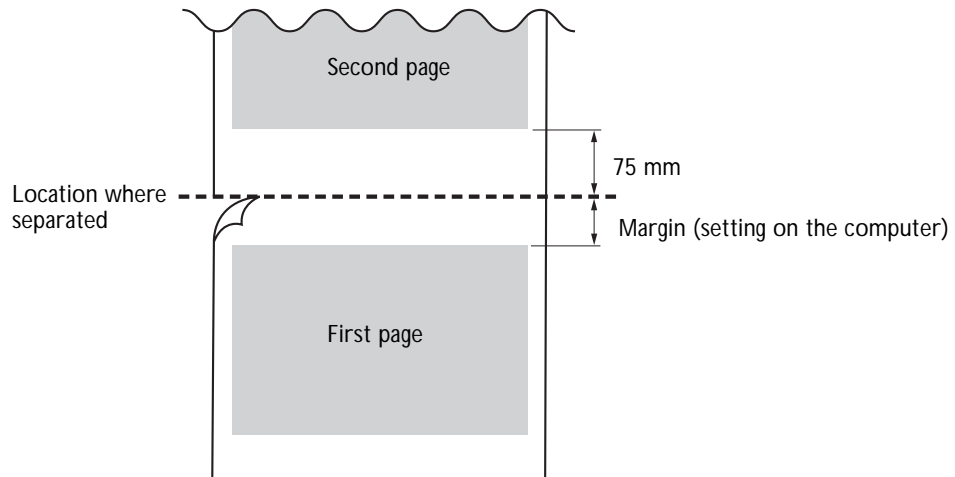

6-3 About the Blade

The cutting conditions and the service life of the blade change according to the media and the operating environment, even when you're using identical blades. The service life also differs according to the type of blade. A rough guide is shown below.

Blade	Media	Blade force	Amount of blade offset	Blade life* (general guide)
ZEC-U1005	General signage vinyl	50 to 150 gf	0.25 mm	8,000 m
ZEC-U5025	General signage vinyl	30 to 100 gf	0.25 mm	4,000 m
	Fluorescent vinyl	120 to 200 gf	0.25 mm	4,000 m
	Reflective vinyl	100 to 200 gf	0.25 mm	4,000 m

When uncut areas remain even when the blade force is increased to a value that is higher by 50 to 60 gf than the values shown in this chart, then replace the blade.

*The values for "Blade life" are estimates for when an identical type of media is used.

6-4 Locations of the Power Rating and Serial Number Labels

Serial Number

This is required when you seek maintenance, servicing, or support. Never peel off the label or let it get dirty.

Power Rating

Use an electrical outlet that meets the requirements for voltage, frequency, and amperage given here.

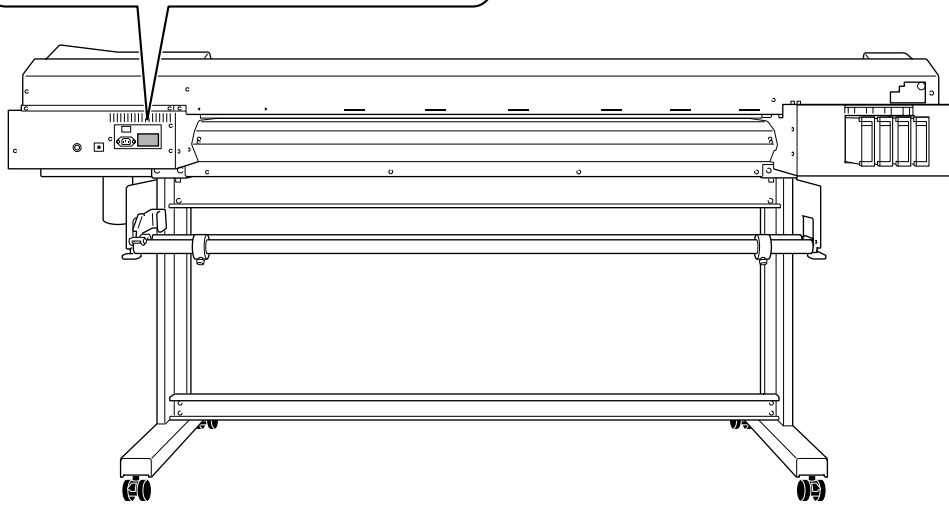

6-5 Specifications

		VP-540	VP-300
Printing technology		Piezoelectric inkjet	
Media	Width	210 to 1,371 mm (8.3 to 54 in.)	182 to 762 mm (7.2 to 30 in.)
	Thickness	Maximum 1.0 mm (39 mil) with liner, for printing Maximum 0.4 mm (16 mil) with liner and 0.22 mm (9 mil) without liner, for cutting	
	Roll outer diameter	Maximum 180 mm (7 in.)	
	Roll weight	Maximum 30 kg (66 lb.)	Maximum 20 kg (44 lb.)
	Core diameter	50.8 mm (2 in.) or 76.2 mm (3 in.)	
Printing/cutting width (*1)		Maximum 1,346 mm (53 in.)	Maximum 736 mm (29 in.)
Ink cartridges	Types	220-cc cartridge / 440-cc cartridge	
	Colors	Four colors (cyan, magenta, yellow, and black)	
Printing resolution (dots per inch)		Maximum 1,440 dpi	
Cutting speed		10 to 300 mm/s	
Blade force		30 to 300 gf	
Cutting blade	Type	Roland CAMM-1 series compatible	
	Blade offset	0 to 1.5 mm (0 to 0.059 in)	
Software resolution (when cutting)		0.025 mm/step	
Distance accuracy (when printing) (*2) (*3)		Error of less than $\pm 0.3\%$ of distance traveled, or ± 0.3 mm, whichever is greater	
Distance accuracy (when cutting) (*3)		Error of less than $\pm 0.4\%$ of distance traveled, or ± 0.3 mm, whichever is greater When distance correction has been performed (when the setting for [CUTTING MENU] - [CALIBRATION] has been made): Error of less than $\pm 0.2\%$ of distance traveled, or ± 0.1 mm, whichever is greater	
Repeatability (when cutting) (*3) (*4)		± 0.1 mm or less	
Alignment accuracy for printing and cutting (*3) (*5)		± 0.5 mm or less	
Alignment accuracy for printing and cutting when reloading media (*3) (*6)		Error of less than $\pm 0.5\%$ of distance traveled, or ± 3 mm, whichever is greater	
Media heating system (*7)		Print heater, setting range for the preset temperature: 30 to 45°C (86 to 112°F) Dryer, setting range for the preset temperature: 30 to 50°C (86 to 122°F)	
Connectivity		Ethernet (10BASE-T/100BASE-TX, automatic switching)	
Power-saving function		Automatic sleep feature	
Power requirements		AC 100 to 120 V $\pm 10\%$, 8.3 A, 50/60 Hz or AC 220 to 240 V $\pm 10\%$, 4.3 A, 50/60 Hz	AC 100 to 120 V $\pm 10\%$, 5.8 A, 50/60 Hz or AC 220 to 240 V $\pm 10\%$, 3.0 A, 50/60 Hz
Power	During operation	Approx. 1,110 W	Approx. 780 W
	Sleep mode	Approx. 34 W	Approx. 33W
Acoustic noise level	During operation	64 dB (A) or less (according to ISO 7779)	64 dB (A) or less (according to ISO 7779)
	During standby	40 dB (A) or less (according to ISO 7779)	40 dB (A) or less (according to ISO 7779)
Dimensions (with stand) (*8)		2,310 (W) x 740 (D) x 1,125 (H) mm (90.9 (W) x 29.1 (D) x 44.3 (H) in.)	1,700 (W) x 740 (D) x 1,125 (H) mm (66.9 (W) x 29.1 (D) x 44.3 (H) in.)
Weight (with stand)		112 kg (247 lb.)	89 kg (196 lb.)
Environmental	Power on (*9)	Temperature: 15 to 32°C (59 to 90°F) (20°C [68°F] or more recommended), humidity: 35 to 80%RH (non-condensing)	
	Power off	Temperature: 5 to 40°C (41 to 104°F), humidity: 20 to 80%RH (non-condensing)	
Accessories		Exclusive stands, power cord, blade, blade holder, media clamps, media flanges, replacement blade for separating knife, cleaning kit, software RIP, User's Manual, etc.	

6-5 Specifications

*1

The length of printing or cutting is subject to the limitations of the program.

*2

- With Roland PET film, print travel: 1 m
- Temperature: 25°C (77°F), humidity: 50%

*3

Not assured when the print heater or dryer is used.

*4

The following conditions must be met:

- Media type: Media specified by Roland DG Corp.
- Roll media must be loaded on the shaft.
- [PREFEED] menu item must be set to "ENABLE."
- Side margins: 25 mm or more for both the left and right margins
- Front margin: 35 mm or more
- Excluding expansion/contraction of the media

Range for assured repetition accuracy

➤ 54-inch model

For media with a width exceeding 610 mm: Length 4,000 mm

For media with a width of 610 mm or less: Length 8,000 mm

➤ 30-inch model

Length 3,000 mm

*5

- Provided that media length is under 3,000 mm
- Temperature: 25°C (77°F)
- Excluding possible shift caused by expansion/contraction of the media and/or by reloading the media.

*6

- Media type : Roland PET film
- Data size: 1,000 mm in the media-feed direction, 1,346 mm (54-inch model) or 736 mm (30-inch model) in the carriage-movement direction
- No lamination
- Automatic detection of crop marks at 4 points when media is reloaded.
- During cutting, [PREFEED] menu item must be set to "ENABLE."
- Temperature: 25°C (77°F)
- Excludes the effects of slanted movement and of expansion and contraction of the media.

*7

- Warm-up is required after powerup. This may require 5 to 20 minutes, depending on the operating environment.
- Depending on the ambient temperature and media width, the preset temperature may fail to be reached.

*8

- Depth when the included ink-cartridge tray is installed is 1,000 mm.

*9

Operating environment

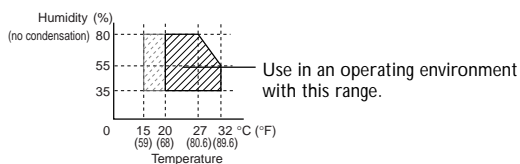



1000003203

R4-080509