

Inkjet printer JV5 series

Request for daily care

Inkjet plotter is the precision machine that has highly delicate mechanism. Especially, little dust and paper powder may have effect on a head nozzle, and may not perform normal printing. To use the inkjet plotter in good condition, we recommend the following daily care.

1. To avoid the following problems (Problems of the print)

If not cleaning the machine for a long time, problems may occur on the print as follows. Please understand the purpose of the maintenance well, and clean the machine properly.

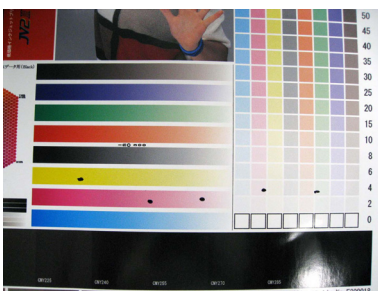

1. Unwanted ink droplets on the print

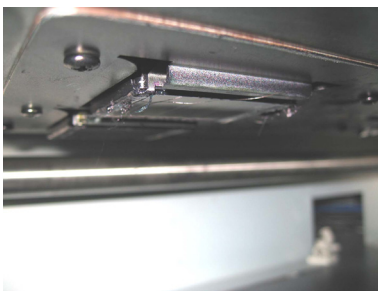

[Cause]
Dust on the media may drop ink on the print.

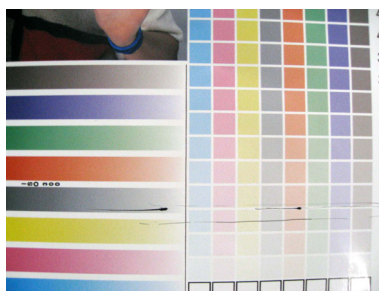

2. Unwanted lines on the print

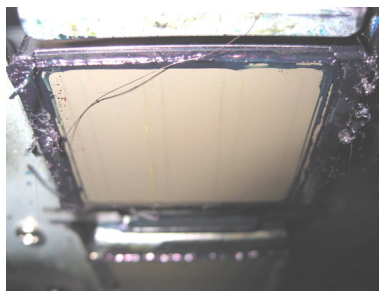
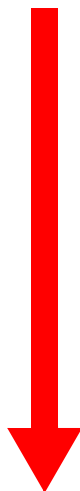

[Cause]
The ink with tiny lint or the like attached may rub on the printing surface during printing, then make the print dirty.

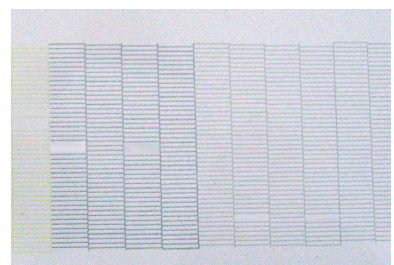

3. Dot missing does not improve even after cleaning.



[Cause]
The piled ink on the head end that is unable to be wiped. The ink attached to the wiper during cleaning closes the nozzle hole, then may cause defective discharge.

To avoid those problems and to print comfortable, clean the machine frequently as indicated on this manual. (Refer to Daily care on this manual.)

2. Daily care



- When possible, use the cleaning stick (SPC-0527) for cleaning around the head/ capping station/ wiper.
Using the other cotton bud may attach lint, then it may damage the machine.

(1) Around heads (Operation manual Chapter 4 “Cleaning the heads and their surrounding parts”)

Dust accumulates most around heads mostly, and it effects the operation and printing results for this plotter, and also as this plotter has very delicate mechanism, need enough attention to the care for it. Gelled ink and dust adhere to the bottom of a slider and around heads, scour off it using a cotton bud. Do not touch the head nozzle.

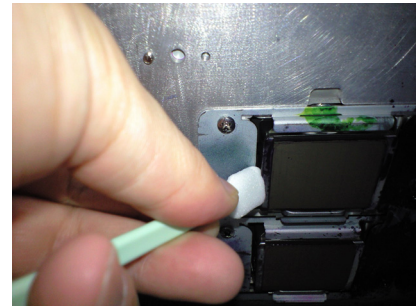

Clean with a cotton bud

(2) Capping station (Operation manual Chapter 4 “Cleaning the wiper and ink caps”)

Around the cap is also the place dust accumulates. Use the following cleaning solution, and clean to prevent dust adhering to the heads.

- For solvent ink users: Cleaning solution MS2/ES3/HS kit (SPC-0369)
- For aqueous ink users: Ink-cleaning kit (SPC-0137)

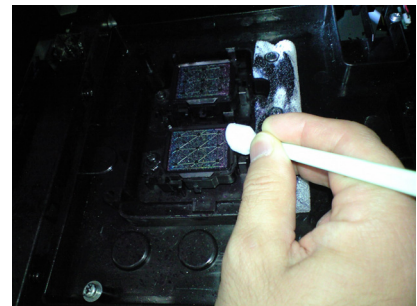

Ink cap

(3) Wiper (Operation manual Chapter 4 “Cleaning the wiper and ink caps”)

Ink and paper powder accumulate on the wiper. Confirm the condition, and clean it if it's dirty. In case it deformed, replace to the new one. (Operation manual Chapter 4 “Replacing the wiper [WIPER EXCHANGE]”)

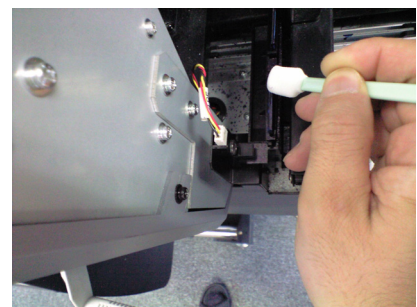

Dirty wiper

(4) Metal paper guide

If cut media waste and dust adhered between metal paper guide and platen, can not perform media feeding and printing normally. Clean this place often.

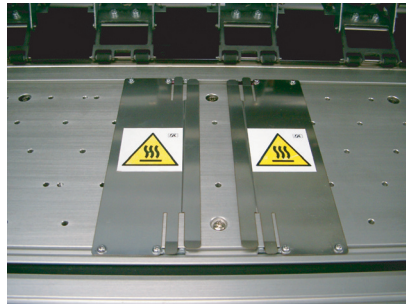

Metal paper guide



Metal paper guide with dust

(5) Media sensor (Operation manual Chapter 4 “Cleaning the head media sensor”)

In case dust and ink adhered to the media sensor, it causes detecting on error. Wipe out dust and ink with a soft cloth.

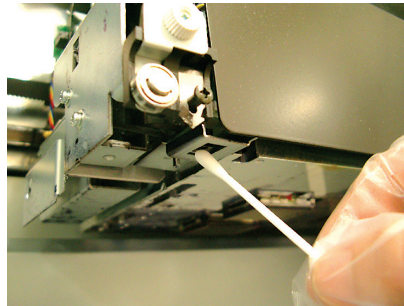

Media sensor at the heads

(6) Platen (Operation manual Chapter 4 “Cleaning the platen”)

Dust and paper powder easily adhered to the platen. Clean it frequently.

Wipe a platen and its cover with a soft brush or a dried cloth. When cleaning a platen, clean well the groove for a media paper guide and the one for media cut (cutter line) etc where easily accumulate the dust.

(7) Outer case (Operation manual Chapter 4 “Cleaning exterior surfaces”)

According to the working environment, the dust and cloud of dust may be adhered. Wring a soft cloth firmly after wetting it with water and wipe out the dust to prevent the head moving part from dust.

(8) Waste ink tank (Operation manual Chapter 4 “When the waste ink tank is full”)

Check the waste ink tank level to prevent overflow.

3.Storage of media

Media should be stored in the little dust area, and not in direct sunlight. Avoid storing the media in the area with high temperature and high humidity.

4.Storage of ink cartridge

Store the ink cartridge in no direct sunlight, and no high humidity.

As it's a delicate product, do not drop it.

The board on an ink cartridge should not be contaminated and discharged static electricity.

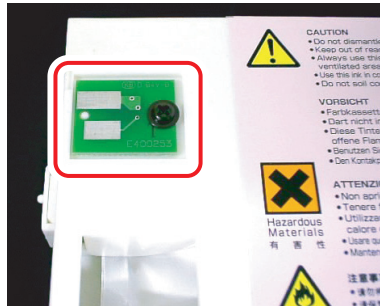

The board on an ink cartridge

5.The examples of defective printing

These following examples indicate improper head (nozzle) firing by dust, which effect printing. Confirm the nozzle condition periodically before or during outputting not to use in such as this condition.

The nozzle condition can be confirmed with [test printing] in this plotter. (Operation manual Chapter 3 “Checking for nozzle clogging, and unclogging nozzles”)

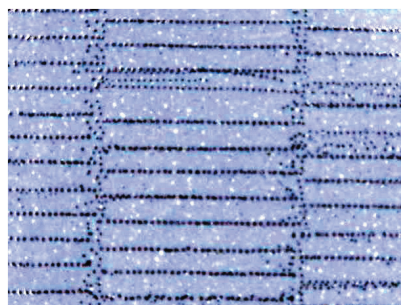

Deflection

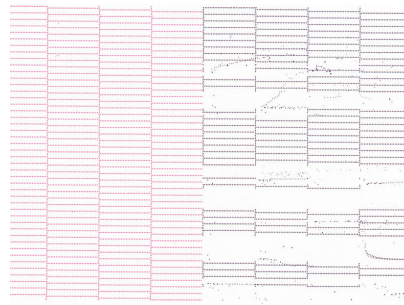

Nozzle out



Ink drooping



Satellite

6. Cleaning of Flushing Box



- When the ink adheres to your skin or enters in your eyes, immediately rinse off completely with water.
- Make sure to wear attached gloves (When solvent ink is used) and goggles to perform the works.



- Be sure to insert the washing liquid cartridge into the rear slot of this machine, and fill the washing liquid.
If the washing liquid is unfilled or not enough, the flushing BOX cannot be automatically washed. It may shorten the life of flushing BOX.

Ink used	Washing/Cleaning liquid cartridge used
ES3 INK	MILD SOVENT WASHING LIQUID (SPC-0294)
HS INK	
Eco-HS1 INK	
Water-based pigment ink	Water-based Cleaning Liquid Cartridge (SPC-0259)
Eco-water-based pigment ink	
Water-based pigment ink	

(1) About Warning messages

When the following warning message appears, quickly clean the lid of the suction fan box.

```
L .1 > [JV5-01]
! Flush. BOX CLEANING
```

- When keeping using it without exchanging after the time above, following message appears and you cannot print.
Replace flushing BOX. Please call our Sales or Service Agent for servicing.

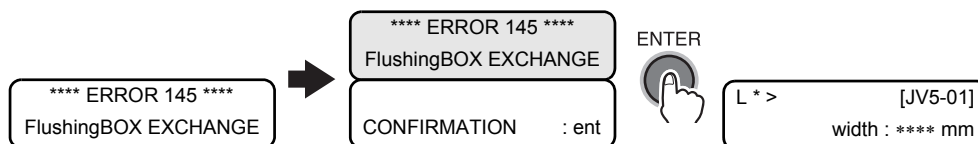

When the warning message above appears 3 times (5 times when water-based ink is used), flushing BOX needs to replace. The message for replacing flushing BOX appears at 3 levels.

- When replacement time is coming, following message appears.
Replace flushing BOX. Please call our Sales or Service Agent for servicing.

```
L .1 > [JV5-01]
! NearExcg. Flush.BOX
```

- When replacement time comes, following message appears, it becomes local mode every time of printing a data and stops the operation.

L .1 > [JV5-01]
! Flush. BOX EXCHANGE

- When keeping using it without exchanging after the time above, following message appears and you cannot print.
Replace flushing BOX. Please call our Sales or Service Agent for servicing.

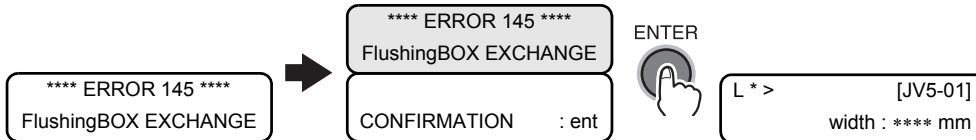

- When the printer is in local mode, if you press the [ENTER] key, you will be able to check if the cleaning or replacing of the flushing box is required soon.

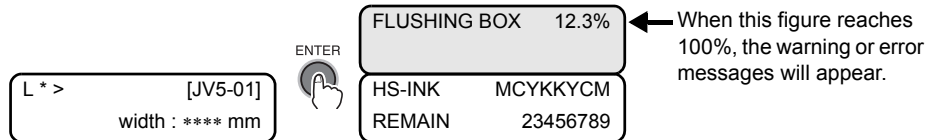

(2) STEPS

Important!

- Be sure to turn off the main power switch since there is the control board and heater supply harness etc. in the pump cover T.

- 1** Press the power switch on the front and make sure that the power is off.

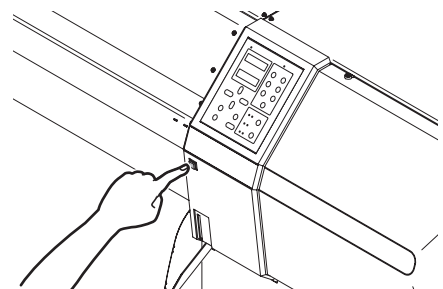

- 2** Turn off the main power switch on the rear side of the unit.

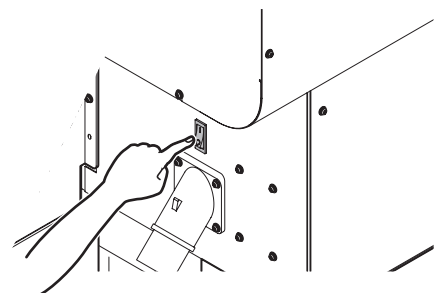

3 Open the pump cover T.

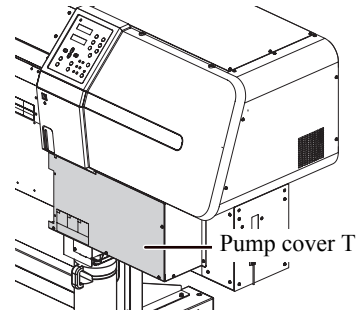

4 Pull out the lid of the suction fan box.

Remove the grip fixing the suction fan box and then pull out the lid of the box.

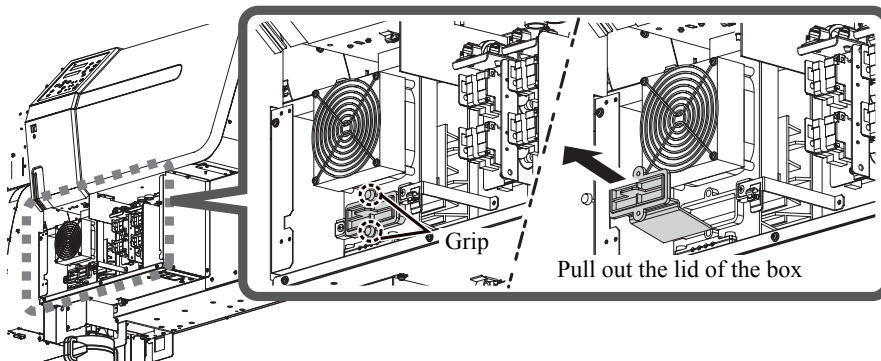
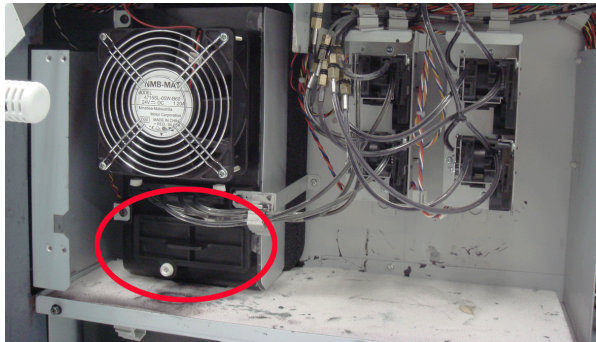

5 Remove the stains stuck on the lid of the box and fix it as originally.

6 Close the pump cover T and turn the power on.

7 Make sure that the printer is in LOCAL mode, and then select [MAINTENANCE] using the [FUNCTION] key and press the [ENTER] key.

If it is in REMOTE mode, press the [REMOTE] key.



8 Select [FLUSHING BOX] by pressing the [▼] key three times and press the [ENTER] key.



9 Select [Cleaning COMP.] and press the [ENTER] key.

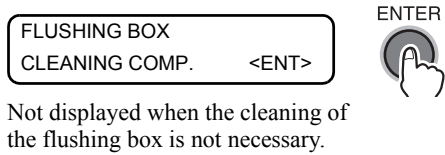

10 Press the [ENTER] key.

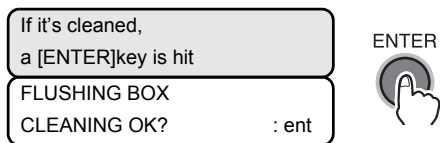

11 Press the [END] key several times.

The printer returns to LOCAL mode.

7. How to recover improper nozzle flashing

When not using this plotter for a long time or according to environmental temperature, nozzle flashing may become unstable. In this case, follow the procedure below to recover nozzle.

1. Daily care

Execute daily care all parts noted on this manual.

2. Normal cleaning (Operation manual Chapter 3 “Checking for nozzle clogging, and unclogging nozzles”)

Execute normal cleaning along the operation manual after executed daily care.

Repeat cleaning and test printing, then confirm the nozzle clogging resolved.

3. Hard cleaning (Operation manual Chapter 3 “Checking for nozzle clogging, and unclogging nozzles”)

If nozzle clogging cannot be solved even executed normal cleaning several times, change the cleaning mode to hard cleaning, and execute the same procedures.

4. Nozzle cleaning (Operation manual Chapter 4 “Cleaning the nozzle [NOZZLE WASH]”)

In case nozzle clogging or other problems can not be cleared away after all these procedures, execute nozzle cleaning.

The execute cleaning and test printing for one minute.

5. Nozzle cleaning (Operation manual Chapter 4 “Cleaning the nozzle [NOZZLE WASH]”)

In case nozzle clogging is not solved with nozzle cleaning above-mentioned, set the TIME to leave 5 minutes, and execute nozzle cleaning and test printing again.

In case nozzle clogging is not resolved with all these procedures, contact with our customer service or make service call to the agency you purchased.

8. Periodical maintenance

Users are advised to perform the maintenance works described below once a week so that the printer will keep its high performance and accuracy over an extended period of its life.

- DISWAY WASH
- PUMP tube cleaning
- Wiper cleaning

9. When the operation of the printer is to be suspended for a long time

When the operation of the printer is to be suspended for a week or more, use the [CUSTODY WASH] function to clean the nozzles in the heads and the ink discharge passage.

After the cleaning, store the printer properly.

10. Supplies

- Clean stick (SPC-0527)
- Solvent wiper kit (SPA-0125)
- When using a solvent ink: Cleaning solution MS2/ES3/HS kit (SPC-0369)
- When using a aqueous ink: Ink-cleaning kit (SPC-0137)

11. Safety Precautions

CAUTION



JV5 is the plotter using the organic solvent ink. Wear supplied goggles and gloves during daily care.

In case water or alcohol mixed into the organic solvent ink, flocculation occurs. Be sure to **not adhere water or alcohol on the nozzle, near the head, the cap, and wiper.**

When not using this plotter for a long time, it is necessary to flash little ink periodically, depending on the installed ink type, to obtain the ink flashing stability.

When not using for a long time, perform the [CUSTODY WASH] function (Operation manual Chapter 4) and turn off the front power switch. The main power switch at rear should be on (The “on” mark described as a vertical line “|” on the switch) and also keep the socket inserted.

Do not disassemble this plotter. It causes an electric shock, fire, and damages.

Be sure to not water into the inside of this plotter. If the inside gets wet, it causes an electric shock, fire, and damages.

Before start the daily care, turn off the power supply, and disconnect an electric cable. It causes unexpected accident.

Do not use benzine, thinner, and the chemicals contained abrasives. The surface of the cover may be deteriorated or deformed.

Do not apply lube oil on the inside of this plotter. The plotter mechanism may be damaged.

12. Installation environment

- Use this plotter in clean (less dust) environment. The use of fan and ventilator might be a cause of dust brow up.
- To use the organic solvent ink, install this plotter in a well-ventilated area.
- This plotter should be used at 20 to 35 °C and 35 to 65% Rh. Avoid using at lower or higher than this temperature and humidity.

memo

Mimaki