

ThermTec



Cyclops

THERMAL MONOCULAR
USER MANUAL

www.thermeyetec.com

support@thermeyetec.com

Table of contents

1. Introduction
 - 1.1 Product Introduction & Features
 - 1.2 Detection Range
 - 1.3 Application Scenarios
 - 1.4 Cautions
2. Packing Instruction
3. Operating Camera
 - 3.1 Charging the Camera
 - 3.2 Power on/off
 - 3.3 Buttons and Controls
 - 3.3.1 Buttons features and introduction
 - 3.3.2. Lens Adjustment
 - 3.3.3 Rocker Operating
 - 3.3.3.1 Zoom
 - 3.3.3.2 Pseudo Color Switch
 - 3.3.3.3 AI distance measurement
 - 3.3.4 Photo/Record
 - 3.4 Settings
 - 3.4.1 Image Setting
 - 3.4.2 System Setting
 - 3.4.3 Network Connections
 - 3.4.3.1 Download App
 - 3.4.3.2 Connect with Wi-Fi
 - 3.4.3.3 Connect with Hotspot
 - 3.4.4 File Management
 - 3.5 External video& Read data
 - 3.6 System Software Upgrades
4. Technical Data
 - 4.1 Datasheet
 - 4.2 Product size & drawing

1. Introduction

1.1 Product Introduction & Features

The Cyclops Series telescope, a new-generation intelligent thermal monocular developed by our company, has a 12 μ m uncooled infrared detector and can be equipped with 15mm/25mm/35mm lens and 1024x768 OLED high-definition display. With the intelligent AI image recognition algorithm, it enables users to see things at a glance even in complete darkness, providing reliable and high-quality visual images for night activities. In particular, the function of connecting with mobile phones brings infinite fun to users' outdoor activities.

Product Features

1. Mechanical rocker design: excellent control performance.
2. 12 μ m VOx detector: provide image with better quality.
3. OLED display: The product adopts a 1024x768 high-resolution OLED display which has a high contrast and is comfortable for human eyes to watch. Moreover, it is adaptable to the environment and can work properly in the harsh environment of minus 20°C.
4. AI intelligent ranging: Based on the deep learning algorithm, the monocular can automatically measure the object distance.
5. Two-way Wi-Fi design: Not only enable user to control or view on app. by connecting monocular with smart devices like mobile phone, meanwhile, also maintain smart devices' existed internet connection via 4G/5G, which allow the user to share the video or image with friends in real time.
6. Photo and video playback.
7. 12-hour endurance.
8. GPS: Enable user to know his own coordinates in real time, which makes field activities safer.
9. Smooth zooming: The product can realize continuous 1.0-6.0 HD zooming. Through the fingertip rocker operation, the eyepiece observation picture can be smoothly zoomed in or out, and the target can be flexibly searched and rapidly locked.
10. IP67 protection design.

1.2 Detection Range

The illustration below shows the comparative range performance of the camera with different lens configurations. The data is based on detecting a man 1.8 meters tall*0.5 meters wide.

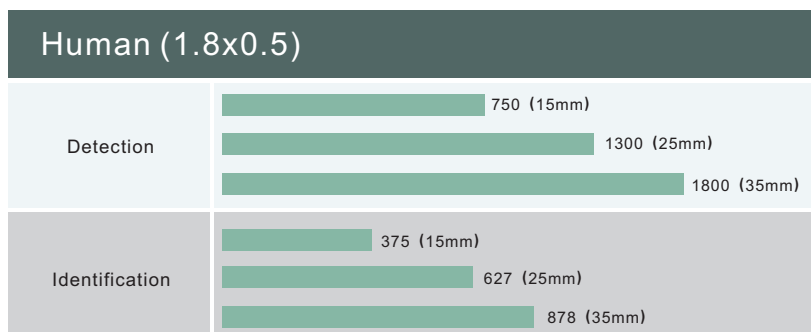

1.3 Application Scenarios

- Animal Observation
- Outdoor Adventure
- Security Law Enforcement
- Emergency Search and Rescue

1.4 Cautions

1. Prevent hard objects from colliding the lens and eyepiece of the thermal imager to avoid damage to the optical lens.

2. Do not aim the lens at high-temperature light sources, such as the sun, to avoid damage to the lens or thermal imaging detector.

3. Do not use the product in extremely cold or hot environment. Refer to the product parameter table for specific temperature requirements.

4. If the thermal imager is not used for a long time, it should be charged once every 3 months during the storage period.

5. To use the product in water environment, first make sure that the USB cover at the bottom of the thermal imager is tightly closed.

6. Do not irradiate the laser indicator of the thermal imager to human eyes.

7. If the thermal imager doesn't work properly, please contact the store or the nearest service center where the thermal imager is purchased. Do not disassemble or modify the thermal imager by yourself in any way.

2. Packing Instruction

Package Content

1*monocular 1*user manual 1*USB cable 1*lanyard 1*carry bag 1* Video output cable

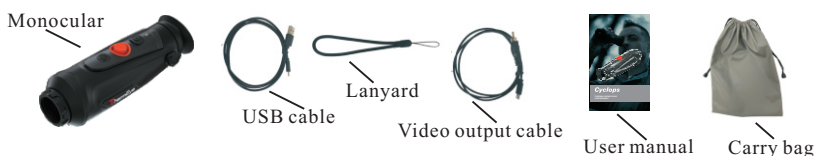

3. Operating Camera

3.1 Charging the Camera

The camera's battery should be fully charged prior to use.

Note: The battery is not user replaceable.

To charge the camera's battery:

1. Lift the cover from the USB port.
2. Plug the cable provided into the camera's USB port.
3. Plug the opposite end of the cable into a USB power source.

source.

Note: When the power sign on the interface is red, it means you need to charge it immediately.

The indicator is red when it is charging and turns green when it finishes charging. After it turns green, stop charging.

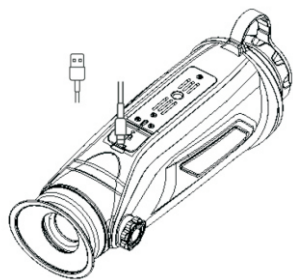

3.2 Power on/off

Power On

Hold the POWER button for four seconds and startup picture will be shown.

Refer to the figure below for the main view of the monocular.

Power Off

When the monocular is turned on, hold the POWER button for four seconds to power off the device.







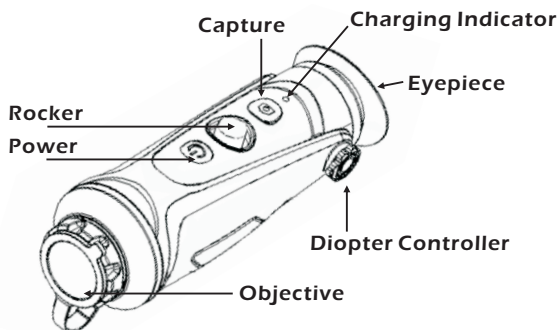

3.3 Buttons and Controls

3.3.1 Buttons features and introduction



Buttons features

	Press and Hold	Press	Double-click
	Power on/off the device.	Turn on/off the laser indicator.	
	Start/Stop record video.	Take a photo.	
	 zoom in  zoom out	 Peseudo color switch  AI distance measurement	Enter the main menu.

3.3.2. Lens Adjustment

Dioptr adjustment

Looking through the eyepiece, adjust the position of dioptr level to optimize the image sharpness on the OLED display.

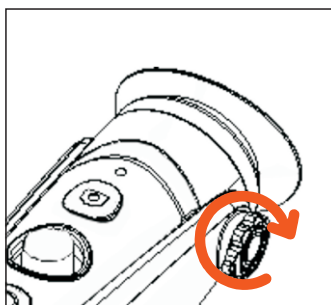

Objective lens focusing

Manually adjust the objective lens focus when necessary.

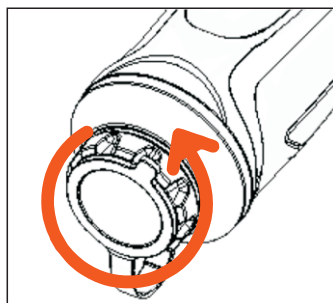

3.3.3 Rocker operating

3.3.3.1 Zoom

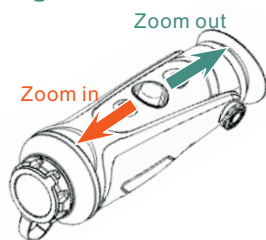

3.3.3.2 Pseudo color switch

Use the rocker key towards the right to switch pseudo color.

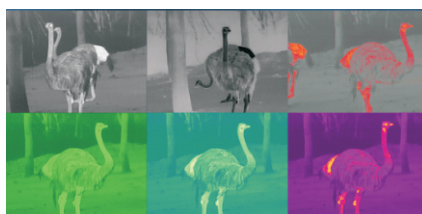
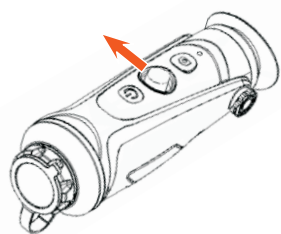

3.3.3.3 AI distance measurement

Use the rocker key towards the left to enable or disable AI distance measurement function (before enable this function, you should make sure if monocular was in AI distance measuring mode, otherwise, refer to 3.4 for setting).

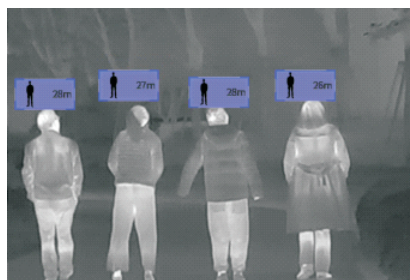
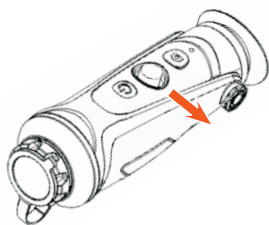

3.3.4 Photo/Record

Press  to take a photo. Then the photo icon in the upper left corner will flash once.

Press  and hold to record. Then the recording icon in the upper left corner starts flashing, and the recording starts timing. Press and hold again to stop recording.

3.4 Settings

Double-click the rocker button to enter Setting menu. Note: select by moving rocker button, confirm the selection by short-press the rocker button.

3.4.1 Image Setting



Mode/Sharpness/Denoise/Brightness/

Contrast/Image settings

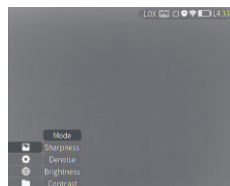

3.4.1

Image settings		
Mode	City mode	Especially enhance target's detail. It's recommended in bad weather.
	Jungle mode	Gain both background and target's detail with wide dynamic algorithm.
Sharpness	0-10	Adjust the image sharpness to make the image edge sharper. Recommend value: 5
Denoise	0-10	Adjust the image noise to make the image cleaner. Recommend value: 5
Brightness	1-10	Adjust the image brightness to make the image brighter. Recommend value: 5
Contrast	1-10	Adjust the image contrast to make the target more prominent in the image. Recommend value: 5

3.4.1

3.4.2 System Setting



Note: select by moving rocker button, confirm the selection by short-press the rocker button.

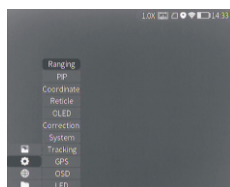

3.4.2

System settings		
Ranging	AI	AI distance measurement
	MIL	MIL distance measurement
PIP	Picture in picture	In the picture, the image is 2x enlarged from the center of the cross.
Coordinate		The position of the crosshair in the picture can be adjusted and separately saved.
Reticle	0-7	Choose the style of the crosshair. 0 represents none, and 1-7 represents seven styles.
OLED	Hue	OLED hue has blue, purple and gray for option.
	Brightness	
Correction	Manual/Auto	The mask works to calibrate the uniformity of the image.
System	Reset	All configuration parameters are restored to the factory default values after reset.
	Update	You can update and upgrade the device system.
	Language	Current system language
	Time zone	Select the local time zone and calibrate the time information.
	Blind pixel	The blind pixel in the picture can be replaced.
Heat tracking		Turn on heat tracking to mark the target with the highest temperature in real time in the screen.
GPS		Turn on GPS to obtain real-time satellite positioning, longitude and latitude coordinates and time information.
OSD		Turn off OSD. The character information superimposed on the screen is turned off and the menu is frozen. Turn on OSD. Menu adjustment is recovered.
LED		Turn off LED. The work indicator is turned off and the hidden work mode is started.

3.4.2

3.4.3 Network Connections

3.4.3.1 Download App

Search "Smart Thermal" on app. Store or scan the QR code to download it.



3.4.3.2 Connect with Wi-Fi

① Open smart device's personal hotspot.

② Enter  by short-press on rocker button, select Wi-Fi to configure.

③ Access the Wi-Fi submenu on monocular and select the Wi-Fi released by smart devices, then enter the password through the rocker button to connect the Wi-Fi.

④ After the monocular connected the Wi-Fi, open the mobile APP to connect monocular.



3.4.3.2 ①

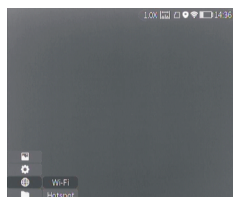

3.4.3.2 ②

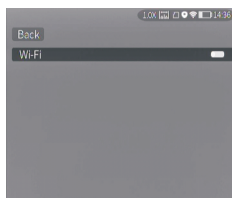

3.4.3.2 ③

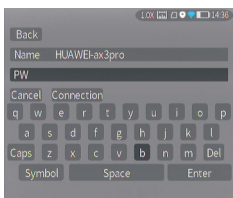

3.4.3.2 ④

3.4.3.3 Connect with Hotspot

① Enter  by short-press on rocker button, select Wi-Fi to configure.

② Access the hotspot submenu, monocular will release a hotspot network. Set the hotspot name and password and confirm them through the rocker button.

③ Enable mobile device to connect with monocular Hotspot by setting the WLAN on mobile device.

④ After mobile device connected with monocular Hotspot, open the mobile APP to connect monocular.

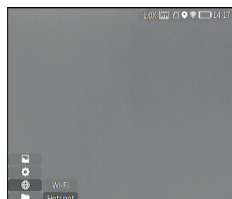

3.4.3.3 ①

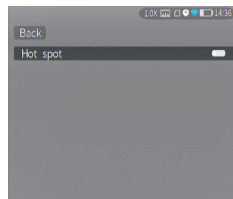

3.4.3.3 ②

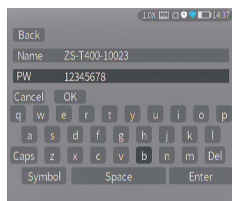

3.4.3.3 ③



3.4.3.3 ④

3.4.4 File Management

Enter  by short-press on rocker button, select the image and video submenus to view the images and videos and play the videos.

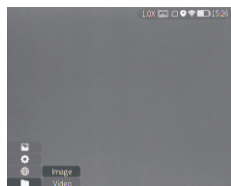

3.4.4

File settings	
Image	Access the image submenu, and select photo files through the rocker button for management.
Video	Access the video submenu, and select video files through the rocker button for management.

3.4.4

3.5 External video& Read data

Power on the device before using a type-C to AV video cable to output analog video. When external display is connected, the OLED of the device automatically turns off the display.

Power on the device, use a type-C to USB cable to connect with the computer to read the video and image data in the memory.

Note: video and image taken in analog format (usually taken by external display with analog output) will be saved in folder named “720”, video and image directly taken by monocular will be saved in folder named “1024”.

3.6 System Software Upgrade

- ① Connect the device to your computer and drag the upgrade file to the folder.
- ② Access the Setup menu and select Upgrade.
- ③ The system will prompt that upgrading is in progress. When the upgrade succeeds, the device will restart automatically.

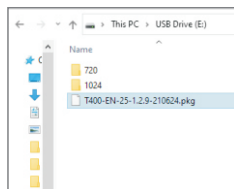

3.6 ①

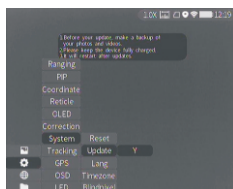

3.6 ②

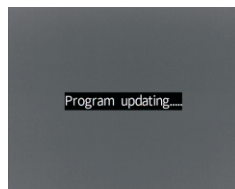

3.6 ③

4. Technical Data

4.1 Datasheet

Sensor Parameters			
Detector Type	Vox Microbolometer		
Resolution / Pixel Spacing	384x288/12um		
NETD	≤40mk@300k		
Frame Rate	50Hz		
Spectral Range	8~14μm		
Lens	15mm (F#0.9, manual focus)	25mm (F#1.0, manual focus)	35mm(F#1.0, manual focus)
FOV	17.5°x 13.1°	10.5°x 7.9°	7.5°x 5.6°
Identification Distance (1.8m man)	375m	627m	878m
Image Processing			
Digital Zoom	1~6x continuous		
Color Palette	5+		
Noise Reduction	3D noise reduction		
Image Enhancement	IDE、HDR		
Display			
OLED	0.39 inch 1024*768 resolution		
Diopter Control	-5~+5		
Eye Distance	40mm		
Function			
OLED	3 modes		
Language	English		
Reticle	6+, adjustable coordinates		
Memory Card	16G		
AI Distance Measurement	Yes		
Photo, Record, Playback	Yes		
Heat Track	Yes		
Laser Indicator	Yes		
GPS	Yes		
Power			
Battery Type	Internal Cell(18650 Li battery x 2)		
Battery Life	Continuous working time ≥ 12h		
Interface			
Type-C	Power charge, read data, output analog video		
Wi-Fi	Two-way Wi-Fi connection, APP remote control		
Environmental Parameters			
Working Temperature	-20°C~+55°C		
Protection Level	IP67, 1 meter drop resistance		
Physical Parameters			
Weight	470g (with battery)		
Size	67mm×63mm×190mm		
Accessories			
External Cable	Analog video cable, USB data cable		
Other Accessory	Wrist strap, plush bag, user manual		

4.2 Dimensions

