

6W, Ultra wide input, isolated & regulated dual/single output, YMD package, DC-DC converter

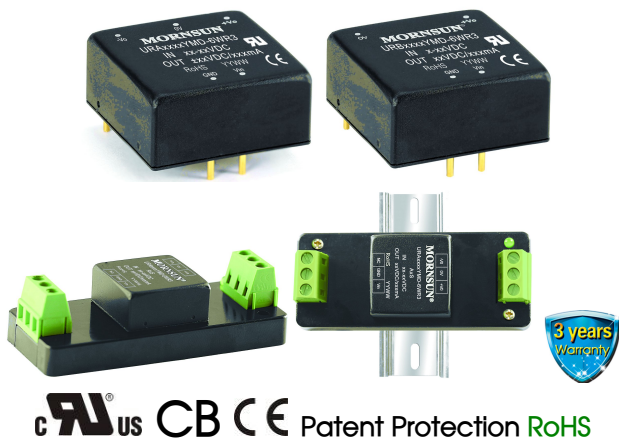

FEATURES

- Wide range of input voltage (4:1)
- Efficiency up to 88%
- No-load power consumption as low as 0.12W
- Isolation voltage :1500VDC
- Input under-voltage protection, output over-voltage, over-current, short circuit protection
- Operating temperature range: -40°C to +85°C
- Meet CISPR22/EN55022 CLASS A
- A2S (wiring mounting) and A4S (35mm rail mounting) products featuring anti-reverse connection for input
- Meet UL60950 , EN60950 and IEC60950
- International standard pin-out

UL US CB CE Patent Protection RoHS

URA_YMD-6WR3 & URB_YMD-6WR3 series are isolated 6W DC-DC products with 4:1 input voltage. They feature efficiency up to 88%, 1500VDC isolation, operating temperature of -40°C ~+85°C, input under-voltage protection, output over-voltage, over-current, short circuit protection and EMI meets CISPR22/EN55022 CLASS A, which make them widely applied in medical care, industrial control, electric power, instruments and communication fields. And extension package A2S and A4S also enable them with reverse voltage protection.

Selection Guide

Certification	Part No. ①	Input Voltage (VDC)		Output		Efficiency ③ (%Min./Typ.) @ Full Load	Max. Capacitive Load ④ (µF)
		Nominal (Range)	Max. ②	Output Voltage (VDC)	Output Current (mA) (Max./Min.)		
UL/CE/CB	URA2405YMD-6WR3	24 (9-36)	40	±5	±600/0	81/83	470
	URA2412YMD-6WR3			±12	±250/0	85/87	100
	URA2415YMD-6WR3			±15	±200/0	86/88	100
	URA2424YMD-6WR3			±24	±125/0	86/88	100
	URB2403YMD-6WR3			3.3	1500/0	77/79	1800
	URB2405YMD-6WR3			5	1200/0	81/83	1000
	URB2409YMD-6WR3			9	667/0	83/85	680
	URB2412YMD-6WR3			12	500/0	85/87	470
	URB2415YMD-6WR3			15	400/0	86/88	220
	URB2424YMD-6WR3			24	250/0	86/88	100
	URA4805YMD-6WR3	48 (18-75)	80	±5	±600/0	81/83	470
	URA4812YMD-6WR3			±12	±250/0	85/87	100
	URA4815YMD-6WR3			±15	±200/0	86/88	100
	URB4803YMD-6WR3			3.3	1500/0	77/79	1800
	URB4805YMD-6WR3			5	1200/0	81/83	1000
	URB4812YMD-6WR3			12	500/0	85/87	470
	URB4815YMD-6WR3			15	400/0	86/88	220
	URB4824YMD-6WR3			24	250/0	86/88	100

Notes:

- ① Part No. with suffix of "A2S" means chassis mounting and suffix of "A4S" means DIN-Rail mounting (e.g. URB2405YMD-6WR3A2S means chassis mounting; URB2405YMD-6WR3A4S means DIN-Rail mounting);
- ② Absolute maximum rating without damage on the converter, but it isn't recommended;
- ③ Efficiency is measured in nominal input voltage and rated output load; A2S (wiring) and A4S (rail) Model due to input reverse polarity protection, minimum efficiency greater than Min.-2 is qualified.
- ④ The capacitive loads of positive and negative outputs are identical.

Input Specifications

Item	Operating Conditions	Min.	Typ.	Max.	Unit
Input Current (full load / no-load)	24VDC input	--	301/5	309/12	mA
	48VDC input	--	150/4	154/8	
Reflected Ripple Current		--	20	--	mA

Input impulse Voltage (1sec. max.)	24VDC input	-0.7	--	50	VDC
	48VDC input	-0.7	--	100	
Starting Voltage	24VDC input	--	--	9	
	48VDC input	--	--	18	
Under-voltage turn-off	24VDC input	5.5	6.5	--	
	48VDC input	14	15.5	--	
Input Filter		Pi filter			
Hot Plug		Unavailable			

Output Specifications

Item	Operating Conditions	Min.	Typ.	Max.	Unit	
Output Voltage Accuracy ^①	0%-100% load	--	±1	±3	%	
Balance of Output Voltage	Dual output, balanced load	--	±0.5	±1.5		
Line Voltage Regulation	Full load, the input voltage is from low voltage to high voltage	Positive output	--	±0.2		±0.5
		Negative output	--	±0.5		±1
Load Regulation ^②	5%-100% load	Positive output	--	±0.5		±1
		Negative output	--	±0.5		±1.5
Cross Regulation	Dual output, main circuit with 50% load, auxiliary circuit with 10%-100% load	--	--	±5		
Transient Recovery Time		--	300	500	μs	
Transient Response Deviation	25% load step change	3.3V, 5V, ±5V output	--	±5	±8	%
		Others	--	±3	±5	
Temperature Drift Coefficient	Full load	--	--	±0.03	%/°C	
Ripple & Noise ^③	20MHz bandwidth, 5%-100% load	--	60	85	mV p-p	
Over-voltage Protection		110	--	160	%Vo	
Over-current Protection	Input voltage range	110	140	190	%Io	
Short circuit Protection		Continuous, self-recovery				

Note: ①At 0%~5% load, the Max. output voltage accuracy of ±5VDC/±9VDC output converter is ±5%.

②When testing from 0% to 100% load working conditions, load regulation index of ±5%;

③0%-5% load ripple & Noise is no more than 5%Vo. Ripple and noise are measured by "parallel cable" method, please see DC-DC Converter Application Notes for specific operation.

General Specification

Item	Operating Conditions	Min.	Typ.	Max.	Unit
Insulation Voltage	Input-output, with the test time of 1 minute and the leak current lower than 1mA	1500	--	--	VDC
Insulation Resistance	Input-output, insulation voltage 500VDC	1000	--	--	MΩ
Isolation Capacitance	Input-output, 100KHz/0.1V	--	1000	--	pF
Operating Temperature	Derating if the temperature is ≥71°C (see Fig. 1)	-40	--	+85	°C
Storage Humidity	Without condensation	5	--	95	%
Storage Temperature		-55	--	+125	°C
Lead Temperature	Welding spot is 1.5mm away from the casing, 10 seconds	--	--	+300	
Vibration		10-55Hz, 10G, 30 Min. along X, Y and Z			
Switching Frequency *	PWM mode	--	300	--	KHz
MTBF	MIL-HDBK-217F@25°C	1000	--	--	K hours

Note:* This series of products using reduced frequency technology, the switching frequency is test value of full load. When the load is reduced to below 50%, the switching frequency decreases with decreasing load.

Physical Specifications

Casing Material	Aluminum alloy	
Dimension	Horizontal package	25.40*25.40*11.70 mm
	A2S chassis mounting	76.00*31.50*21.20 mm
	A4S DIN-rail mounting	76.00*31.50*25.80 mm
Weight	Horizontal package/A2S wiring package/A4S rail package 14g /36g /56g(Typ.)	
Cooling method	Free convection	

EMC Specifications

EMI	CE	CISPR22/EN55022	CLASS A (Bare component)/ CLASS B (see Fig.3-② for recommended circuit)
	RE	CISPR22/EN55022	CLASS A (Bare component)/ CLASS B (see Fig.3-② for recommended circuit)
EMS	ESD	IEC/EN61000-4-2	Contact ±4KV perf. Criteria B
	RS	IEC/EN61000-4-3	10V/m perf. Criteria A
	EFT	IEC/EN61000-4-4	±2KV (see Fig.3-① for recommended circuit) perf. Criteria B
	Surge	IEC/EN61000-4-5	±2KV (see Fig.3-① for recommended circuit) perf. Criteria B
	CS	IEC/EN61000-4-6	3 Vr.m.s perf. Criteria A
	Voltage dips, short interruptions and voltage variations immunity	IEC/EN61000-4-29	0-70% perf. Criteria B

Product Characteristic Curve

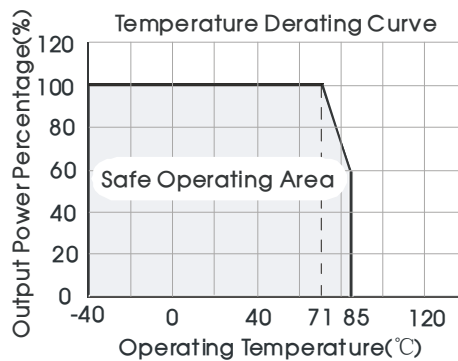
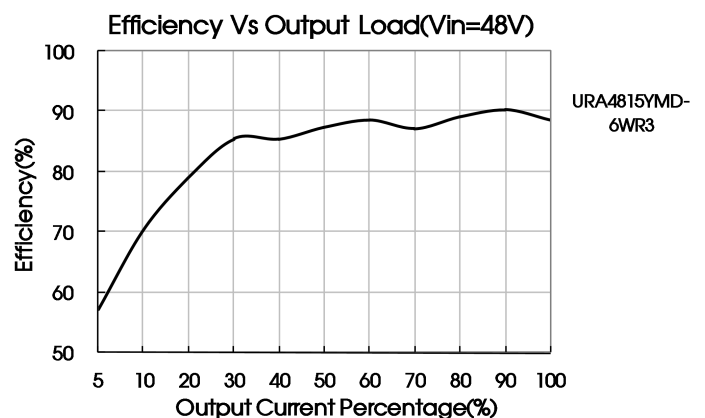
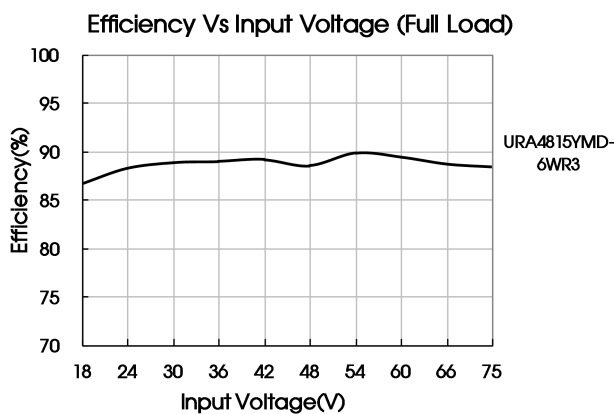
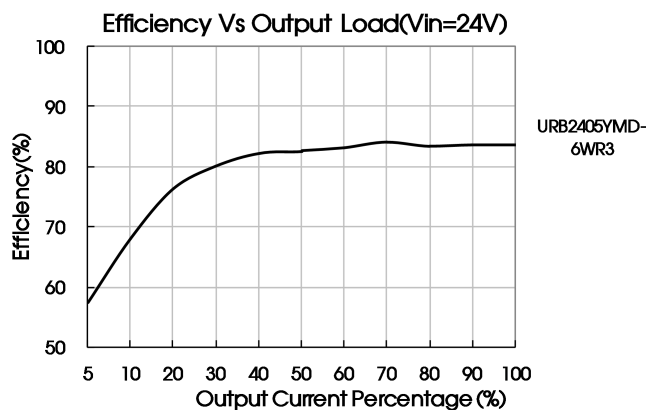
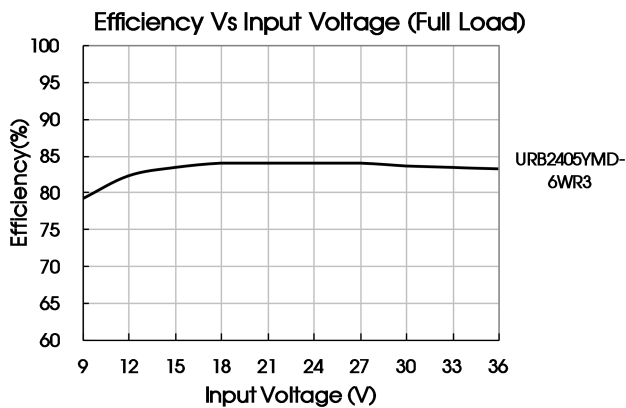

Fig. 1





Design Reference

1. Typical application

All the DC/DC converters of this series are tested according to the recommended circuit (see Fig. 2) before delivery. If it is required to further reduce input and output ripple, properly increase the input & output of additional capacitors C_{in} and C_{out} or select capacitors of low equivalent impedance provided that the capacitance is no larger than the max. capacitive load of the product.

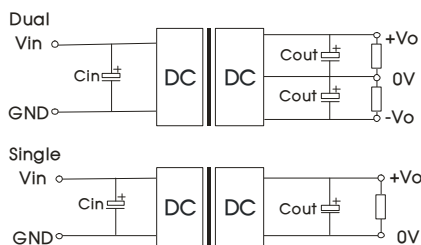

Fig. 2

Vin(VDC)	Cin(uF)	Cout(uF)
24	100	10
48	10~47	10

2. EMC solution-recommended circuit

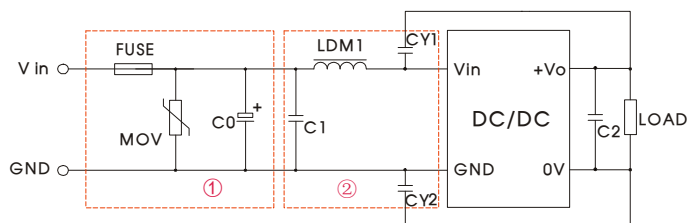

Fig. 3

Notes: Part ① in the Fig. 3 is used for EMS test and part ② for EMI filtering; selected based on needs.

Parameter description

Model	Vin:24V	Vin:48V
FUSE	Choose according to actual input current	
MOV	S14K35	S14K60
C0	330μF/50V	330μF/100V
C1	1μF/50V	1μF/100V
C2	Refer to the Cout in Fig.2	
LDM1	4.7μH	
CY1/CY2	1nF/2KV	

EMC solution-recommended circuit PCB layout

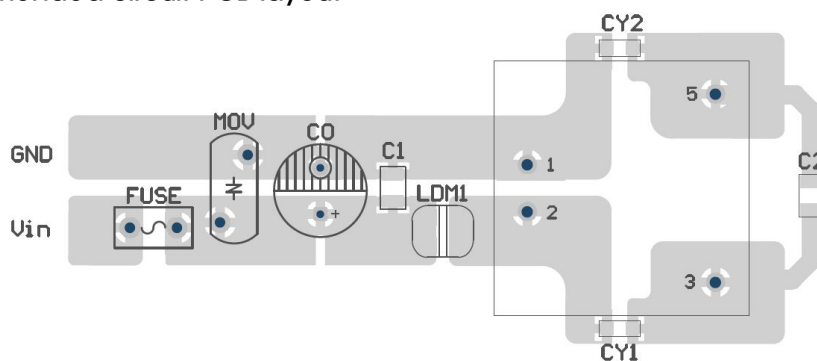
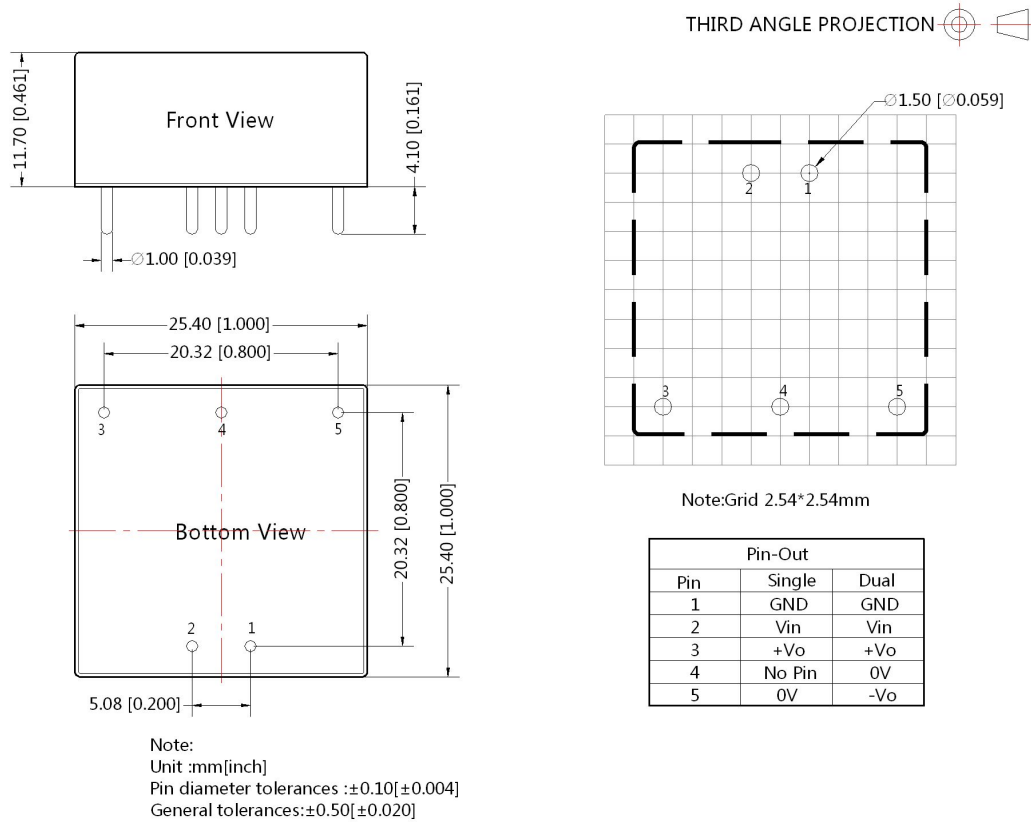

Fig. 4

Note: the min. distance of the bonding pads between input & output isolation capacitors (CY1/CY2) shall be $\geq 2\text{mm}$.

- It is not allowed to connect modules output in parallel to enlarge the power
- For more information please find DC-DC converter application notes on www.mornsun-power.com

Dimensions and Recommended Layout



URA_YMD-6WR3A2S & URB_YMD-6WR3A2S Dimensions

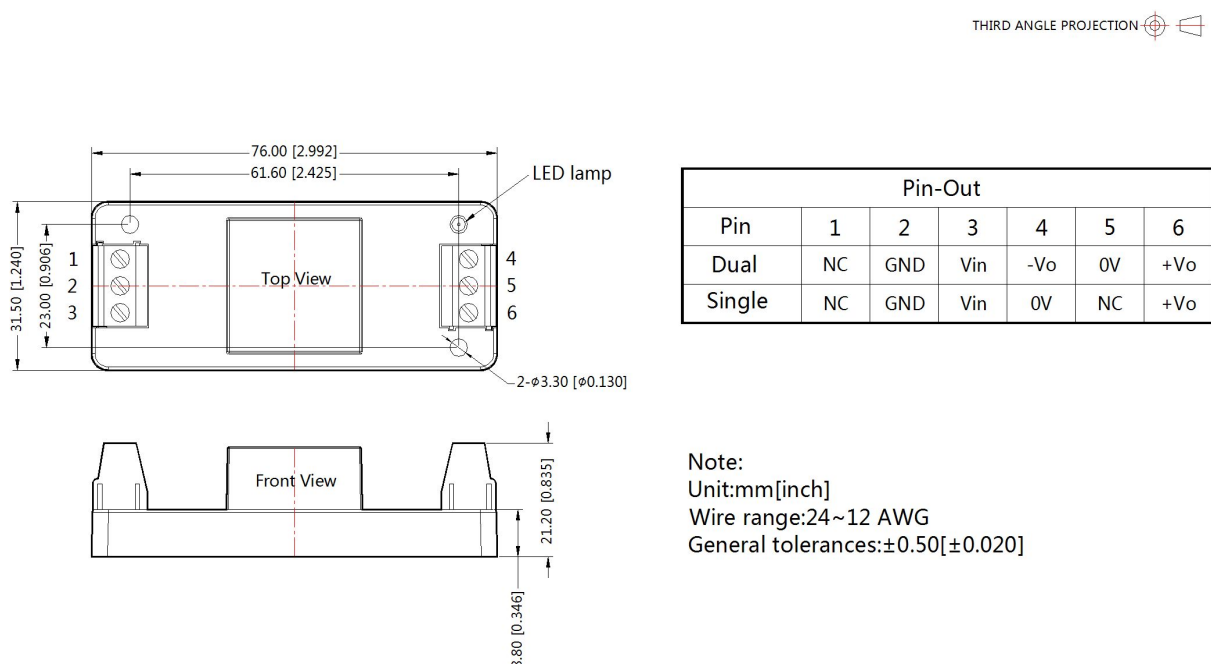

URA_YMD-6WR3A4S & URB_YMD-6WR3A4S Dimensions

THIRD ANGLE PROJECTION 

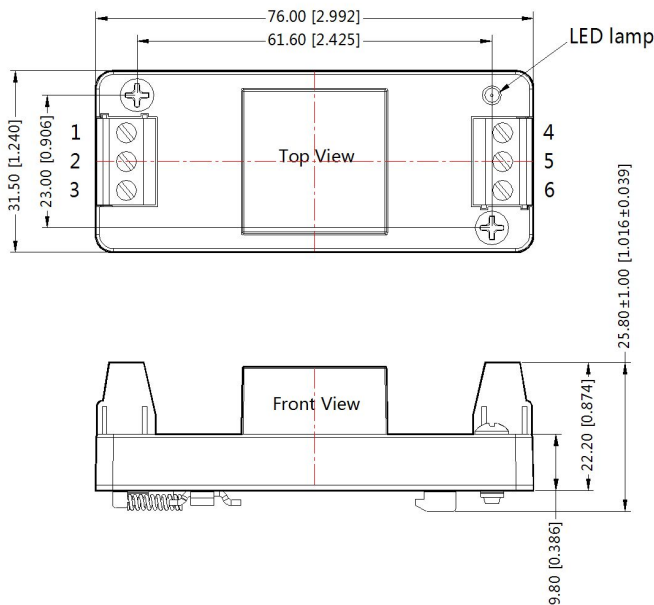

Pin-Out						
Pin	1	2	3	4	5	6
Dual	NC	GND	Vin	-Vo	0V	+Vo
Single	NC	GND	Vin	0V	NC	+Vo

Note:
 Unit:mm[inch]
 Wire range:24~12 AWG
 General tolerances:±0.50[±0.020]

- Note:
1. Packing information please refer to Product Packing Information which can be downloaded from www.mornsun-power.com.Packing bag number : 58210003(DIP),58220022(A2S/A4S package);
 2. The recommended unbalance degree of the dual output module load is $\leq \pm 5\%$; if the degree exceeds $\pm 5\%$, than the product performance cannot be guaranteed to comply with all parameters in the datasheet. Please contact our technicians directly for specific information;
 3. The maximum capacitive load offered were tested at nominal input voltage and full load;
 4. Unless otherwise specified, parameters in this datasheet were measured under the conditions of $T_a=25^\circ\text{C}$, humidity<75% with nominal input voltage and rated output load;
 5. All index testing methods in this datasheet are based on our Company's corporate standards;
 6. The performance parameters of the product models listed in this manual are as above, but some parameters of non-standard model products may exceed the requirements mentioned above. Please contact our technicians directly for specific information;
 7. We can provide product customization service;
 8. Specifications are subject to change without prior notice.

Mornsun Guangzhou Science & Technology Co., Ltd.

Address: No. 5, Kehui St. 1, Kehui Development Center, Science Ave., Guangzhou Science City, Luogang District, Guangzhou, P. R. China
 Tel: 86-20-38601850-8801 Fax: 86-20-38601272 E-mail: info@mornsun.cn