

MORNSUN®

IF_S-1W & IF_D-1W Series 1W, FIXED INPUT, ISOLATED & REGULATED SINGLE OUTPUT DC-DC CONVERTER

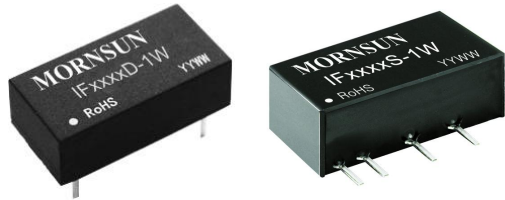

Patent Protection RoHS

MODEL SELECTION

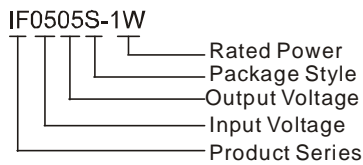

FEATURES

- | Small Footprint
- | SIP/DIP Package
- | 3KVDC Isolation
- | Temperature Range: -40°C to +85°C
- | No Heat sink Required
- | Internal SMD Construction
- | No External Component Required
- | Industry Standard Pinout
- | RoHS Compliance

APPLICATIONS

The IF_S-1W & IF_D-1W Series are specially designed for applications where a group of polar power supplies are isolated from the input power supply in a distributed power supply system on a circuit board.

These products apply to:

- 1) Where the voltage of the input power supply is fixed (voltage variation $\leq \pm 5\%$);
- 2) Where isolation is necessary between input and output (isolation voltage $\leq 3000\text{VDC}$);
- 3) Where the regulation of the output voltage and the output ripple noise are demanded.

PRODUCT PROGRAM

Model	Input Voltage (VDC)		Output Voltage (VDC)	Output Current (mA)		Input Current (mA)(Typ.)		Efficiency(%) @Max. Load	
	Nominal	Range		Max.	Min.	@Max. Load	@No Load	Min.	Typ.
IF0505S-1W	5	4.75-5.25	5	200	20	303	30	62	66
IF0509S-1W			9	111	12	286		66	70
IF0512S-1W			12	83	9	278		68	72
IF0515S-1W			15	67	7	274		69	73
IF0505D-1W			5	200	20	303		62	66
IF0512D-1W			12	83	9	278		68	72
IF1205S-1W	12	11.4-12.6	5	200	20	124	15	63	67
IF1212S-1W			12	83	9	114		69	73
IF1215S-1W			15	67	7	113		70	74
IF1205D-1W			5	200	20	124		63	67
IF2405S-1W	24	22.8-25.2	5	200	20	62	8	63	67
IF2412S-1W			12	83	9	57		69	73
IF2415S-1W			15	67	7	56		70	74
IF2405D-1W			5	200	20	62		63	67

Note: The IF_S(D)-W25 Series also available in our company.

OUTPUT SPECIFICATIONS

Item	Test condition	Min.	Typ.	Max.	Unit
Line regulation	For V_{in} change of $\pm 5\%$	--	--	± 0.25	%
Load regulation	10% to 100% load	--	± 1	± 2	
Output voltage accuracy	100% load	--	--	± 3	
Temperature drift	100% load	--	--	0.03	%/°C
Output ripple*	20MHz Bandwidth	--	10	20	mVp-p
Output Noise*	20MHz Bandwidth	--	50	100	

*Test ripple and noise by "parallel cable" method. See detailed operation instructions at DC-DC Application Notes.

COMMON SPECIFICATION

Item	Test Conditions	Min.	Typ.	Max.	Unit
Storage humidity range	Non condensing	--	--	95	%

Operating temperature		-40	--	85	°C
Storage temperature		-55	--	125	
Lead temperature	Ta=25°C	--	15	25	
Temp. rise at full load	1.5mm from case for 10 seconds	--	--	300	
Cooling		Free air convection			
Case material		Plastic(UL94-V0)			
Short circuit protection	*IFXX05S/D-1W	--	--	1	S
	Others	Continuous			
Switching Frequency	100% load, Input voltage range	--	120	300	KHz
MTBF		3500	--	--	K hours
Weight	IF_S-1W / IF_S-W75	--	2.1	--	g
	IF_D-1W / IF_D-W75	--	2.4	--	g

*Supply voltage must be discontinued at the end of short circuit duration.

ISOLATION SPECIFICATIONS

Item	Test condition	Min.	Typ.	Max.	Unit
Isolation voltage	Input-Output, tested for 1 minute and leakage current less than 1 mA	3000	--	--	VDC
Isolation resistance	Input-Output, test at 500VDC	1000	--	--	MΩ
Isolation Capacitance	Input-Output, 100KHz/0.1V	--	60	--	pF

TYPICAL CHARACTERISTICS

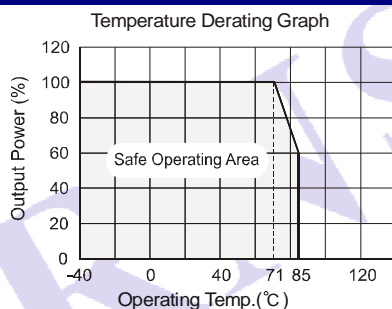

OUTLINE DIMENSIONS & PIN CONNECTIONS

IF_S-1W / IF_S-W75

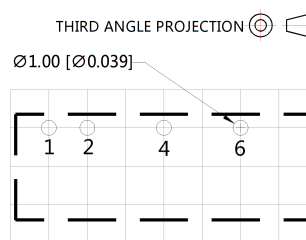
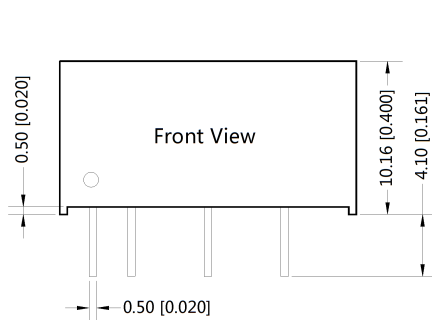

Note : Grid 2.54*2.54mm

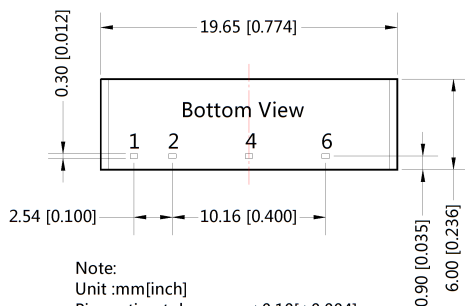

Note:
Unit :mm[inch]
Pin section tolerances :±0.10[±0.004]
General tolerances:±0.25[±0.010]

Pin-Out	
Pin	Function
1	Vin
2	GND
4	0V
6	+Vo

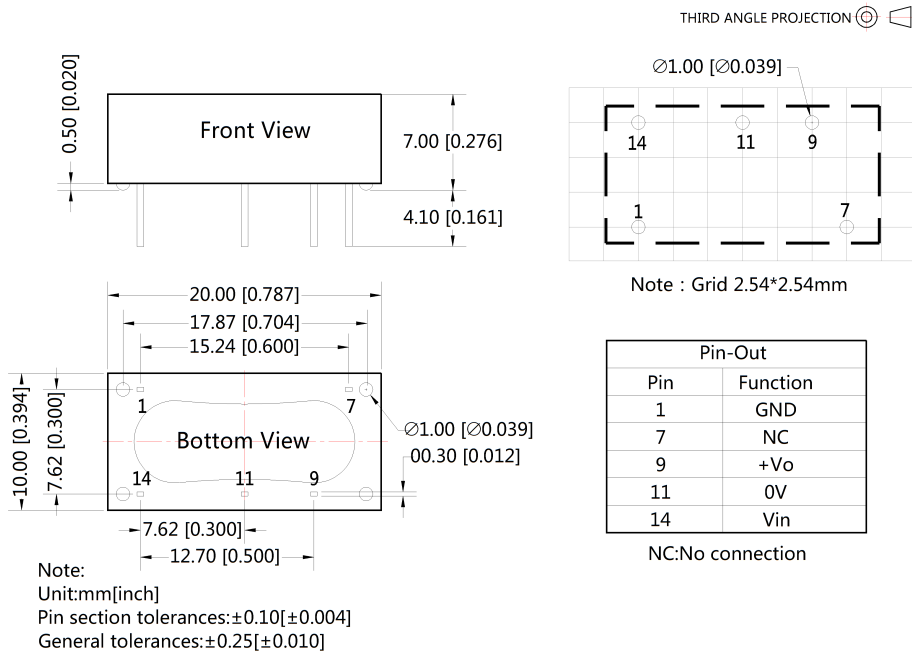

APPLICATION NOTE

1) Requirement on output load

To ensure this module can operate efficiently and reliably, During operation, the minimum output load could not be less than 10% of the full load. If the actual output power is very small, please connect a resistor with proper resistance at the output end in parallel to increase the load.

2) Recommended circuit

If you want to further decrease the input/output ripple, an "LC" filtering network may be connected to the input and output ends of the DC/DC converter, see (Figure 1).

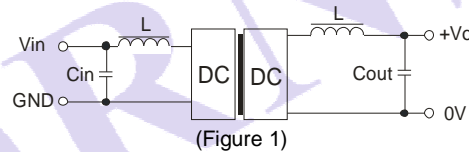

It should also be noted that the inductance and the frequency of the "LC" filtering network should be staggered with the DC/DC frequency to avoid mutual interference. However, the capacitance of the output filter capacitor must be proper. If the capacitance is too big, a startup problem might arise. For every channel of output, provided the safe and reliable operation is ensured, the greatest capacitance of its filter capacitor sees (Table 1).

EXTERNAL CAPACITOR TABLE (TABLE 1)

Vin (VDC)	Cin (μF)	Vout (VDC)	Cout (μF)
5	4.7	5	10
12	2.2	9	4.7
24	1	12	2.2
-	-	15	1

It's not recommend to connect any external capacitor in the application field with less than 0.5 watt output.

3) Overload Protection

Under normal operating conditions, the output circuit of these products has no protection against over-current and short-circuits. The simplest method is to connect a self-recovery fuse in series at the input end or add a circuit breaker to the circuit.

4) Input Over-voltage Protection Circuit

The simplest device for input over-voltage protection is a linear voltage regulator with overheat protection that is connected to the input end in series (Figure 2).

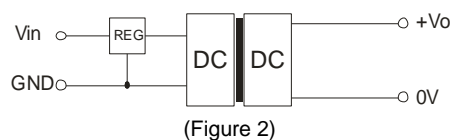

5) When the environment temperature is higher than 71°C, the product output power should be less than 60% of the rated power.

6) It is not recommended to increase the output power capability by connecting two or more converters in parallel. The product is not hot-swappable.

Note:

1. Operation under minimum load will not damage the converter; However, they may not meet all specifications.
2. Max. Capacitive Load is tested at nominal input voltage and full load.
3. Unless otherwise noted, All specifications are measured at $T_a=25^{\circ}\text{C}$, humidity<75%, nominal input voltage and rated output load.
4. In this datasheet, all test methods are based on our corporate standards.
5. All characteristics are for listed models, and non-standard models may perform differently. Please contact our technical support for more detail.
6. Please contact our technical support for any specific requirement.
7. Specifications of this product are subject to changes without prior notice.

MORNSUN Science & Technology Co.,Ltd.

Address: No. 5, Kehui St. 1, Kehui development center, Science Ave., Guangzhou Science City, Luogang district, Guangzhou,P.R.China.

Tel: 86-20-38601850

Fax:86-20-38601272

E-mail: info@mornsun.cn

[Http://www.mornsun-power.com](http://www.mornsun-power.com)

MORNSUN