

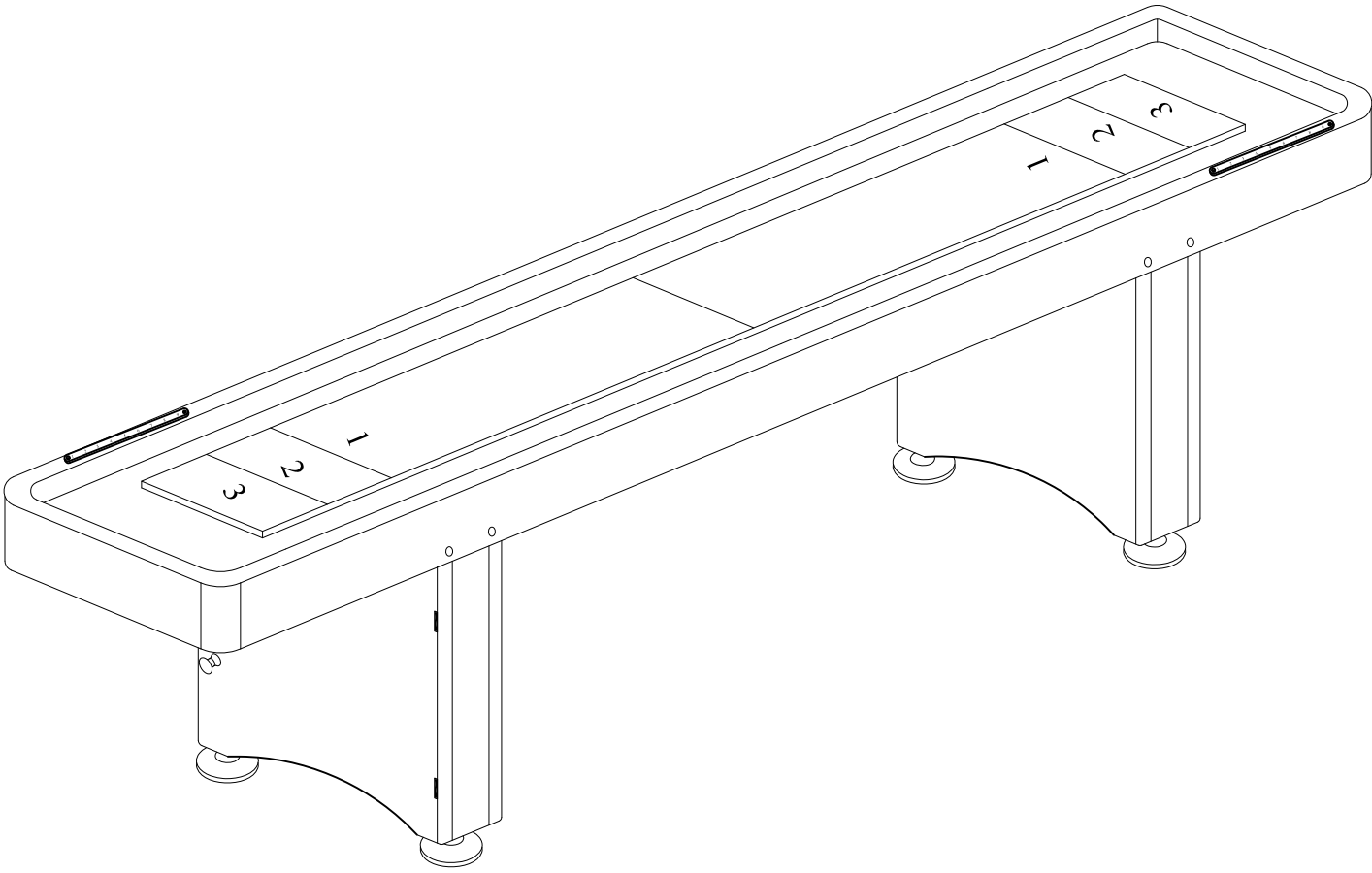

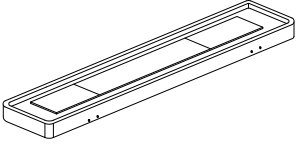

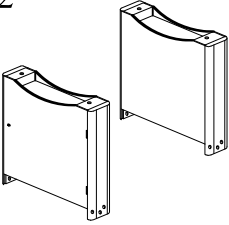
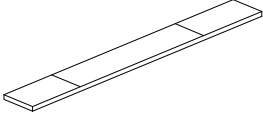

INSTRUCTION MANUAL

FOR SHUFFLEBOARD

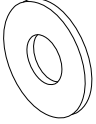
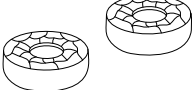
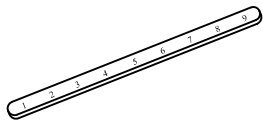

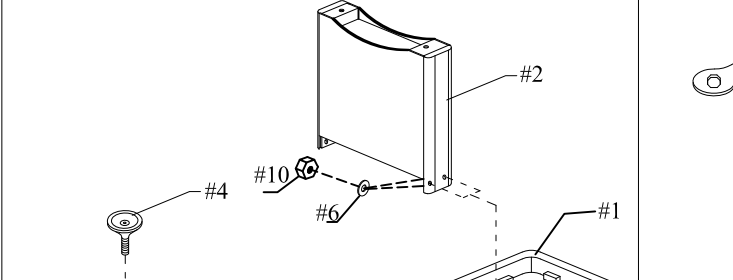
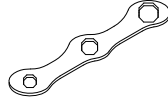
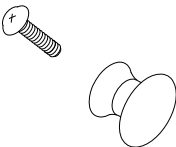
ASSEMBLY INSTRUCTION

<p>#1</p>  <p>Cabinet 1 pc</p>	<p>#2</p>  <p>Leg 2 pcs</p>	<p>#3</p>  <p>Board 1 pc</p>	<p>#4</p>  <p>Leg Leveler 4 pcs</p>	<p>#5</p>  <p>3/8"*3" Bolt 8 pcs</p>
<p>#6</p>  <p>3/8"*23mm Washer 8 pcs</p>	<p>#7</p>  <p>Red and blue puck each 4 pcs</p>	<p>#8</p>  <p>counters 2 pcs</p>	<p>#9</p>  <p>T3*12 4 PCS</p>	<p>#10</p>  <p>Nut 8 pcs</p>
 <p>Figure 1 shows the cabinet (#1) with legs (#2) being attached. A bolt (#5) and washer (#6) are used to secure the leg to the cabinet. A leg leveler (#4) is also shown being installed on the leg.</p>		<p>#11</p>  <p>Wrench 1 pc</p>	<p>#12</p>  <p>Handle 1 set</p>	<p>#13</p>  <p>Shuffleboard speed wax 1 pc</p>

Step 1: Assembly of Legs

* Use blot(#5) and washer(#6) nuts(#10)to secure leg(#2) to cabinet(#1) as shown in the figure 1.

* Install leg levelers(#4) as shown in the figure 1.

FIGURE 1

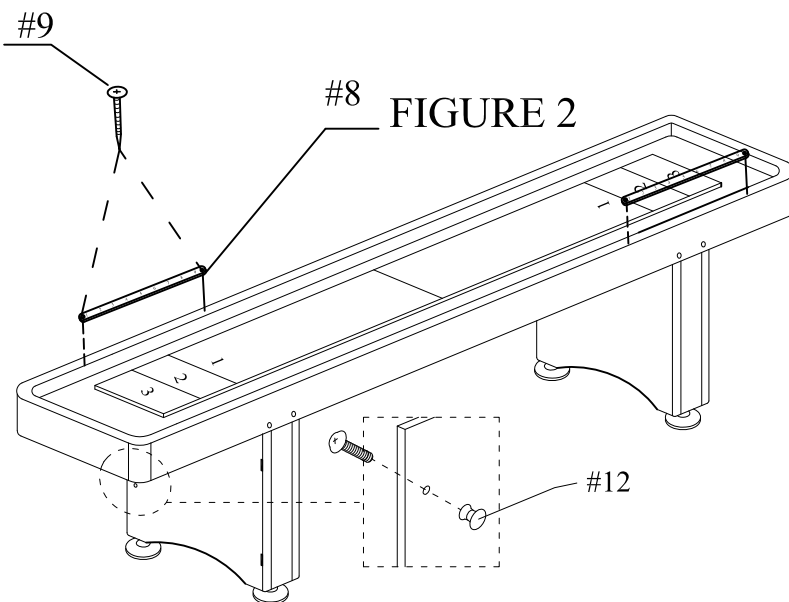

Step 2: Assembly of slide scorer and handle

NOTE: Do not allow the weight of the table to rest on the side of the legs. Use two person or more persons to turn the table right side up.

* Use blot to handle(#12) to secure leg(#2) as shown in the figure 2.

* Use screw(#9) to attach the counters(#8) to the cabinet as shown.