

INSTRUCTION MANUAL FOR SHUFFLEBOARD

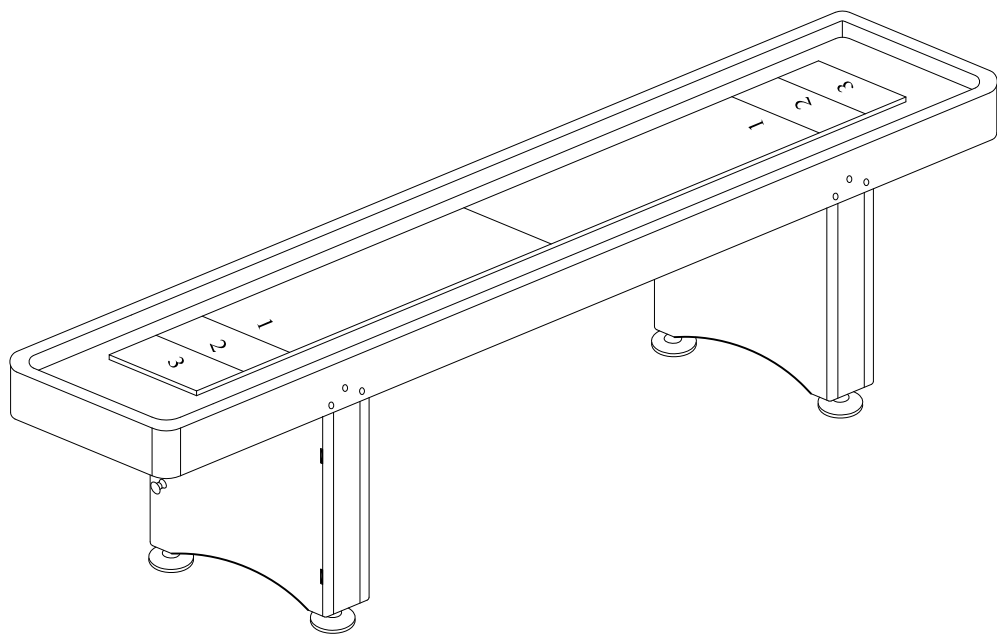

ASSEMBLY INSTRUCTION







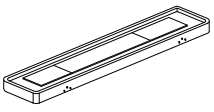
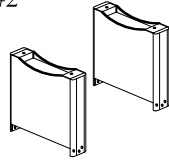
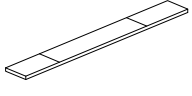

#1  Cabinet 1 pc	#2  Leg 2 pcs	#3  Board 1 pc	#4  Leg Leveler 4 pcs	#5  5/16"*2-1/4" Bolt 12 pcs	
#6  5/16"*23mm Washer 12 pcs	#7  Red and blue puck each 4 pcs	#8  Slide scoring unit 2 set	#9  Screw F4*1-1/2" 4 pcs	#10  Wood cap 4 pcs	
		#11  Wrench 1 pc	#12  Handle 1 set	#13  Shuffleboard speed wax 1 pc	#14  Wrench 1 pc

FIGURE 1

Step 1: Assembly of Legs

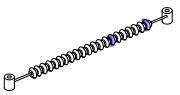
* Use blot(#5) and washer(#6) to secure leg(#2) to cabinet(#1) as shown in the figure 1.

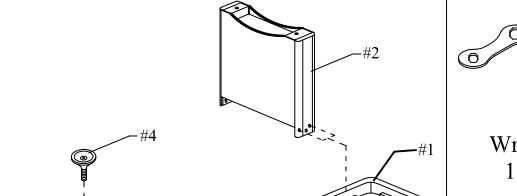
* Install leg levelers(#4) as shown in the figure 1.

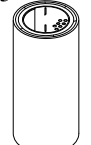
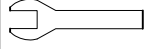
FIGURE 2

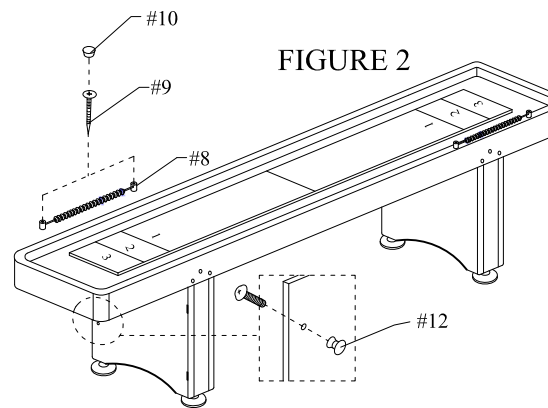

Step 2: Assembly of slide scorer and handle

NOTE: Do not allow the weight of the table to rest on the side of the legs. Use two person or more persons to turn the table right side up.

* Use blot to handle(#12) to secure leg(#2) as shown in the figure 2.

* Use screw(#9) to attach the wood scorer(#8) to the cabinet as shown.

* Put the wood cap(#10) into screw holes.