

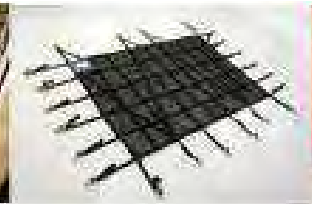

AEROTEX
I N T E R I O R S

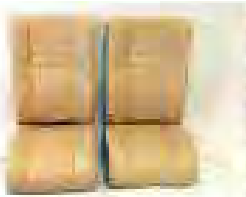

2013/14
HELICOPTER
COVERS & INTERIORS

INTRODUCTION

About Us

Aerotex Interiors Inc. is the Premier Aircraft Upholstery Company in Western Canada. We are located in Calgary, Alberta, Canada, and have specialized in the Refurbishing and Reupholster of Aircraft Interiors and Aircraft Covers since 1995. Our products and service line has since expanded into aircraft covers, helicopter interiors, wallblankets, seat belt repairs, cargo nets and custom interiors to fit all your aircraft needs. Please take your time and browse through our catalogue to view what we have to offer. We are certified to Repair Aircraft Restraint Systems and Crew Restraint Systems since September 2001 (See page 148-149 for more information).

Our Goal

Our goal is to provide you with quality aircraft products for our customer's needs. We are very proud of our company, so we are continually striving to improve and evolve our products and services.

Our History

The Founder of Aerotex Interiors Inc., Suki Chanthyvong, brings over 30 years of knowledge and experience to his many distinguished clients. He started the company in 1994, and since then he has come to be exceptionally well known and respected in the aircraft industry.

His son Carson Chanthyvong, current President, has continued the family tradition while constantly striving to bring in fresh ideas for product development, and to expand the company in new directions.







AEROSPATIALE

Helicopter Covers.....pg 10

Passenger Seats.....pg 13





AEROSPATALE - HELICOPTER COVERS

Bubble / Window Covers

Made of our custom layered laminated material. The outside layer is made of a Nylon Codura which is water repellent, breathable and reflective. The inside layer is a soft inner lining. All engine and window covers are sewn on with a green (right side) and red (left side) indicator patches, for ease of installation.

Available in **Grey**

Main / Trail Rotor Blade Covers

Our blade covers are made of two different types of material:

Medium Weight Nylon - Recommended for Dry Cold Winters Areas

Heavy Weight Tarp - Recommended for Moist Rainy Areas

Available in Nylon **Red** and Tarp **Black** or **Silver**

Blade Tie-Downs / Intake Covers

All our blade tie-downs and intake covers are made of a Heavy-duty Polyester Scrim, all sewn on and secured with heavy duty nylon webbing or bungee hooks.

Available in **Red**

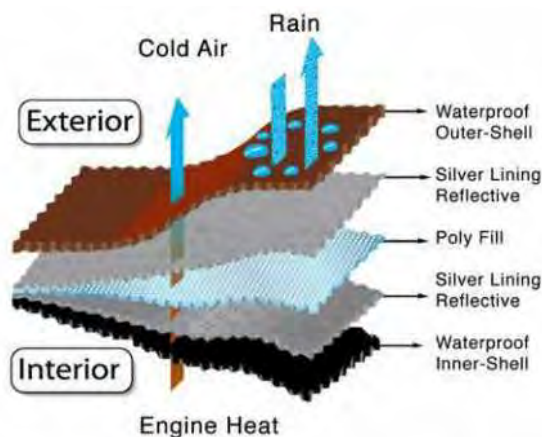

Insulated Covers

Being in Canada and having to experience very cold winter conditions, we know what it takes to keep your aircraft warm.

Through our vigorous R&D and years of experience we have come up with the best insulated covers in the industry.

Available in **Black** or **Red**

Engine / Exhaust Plugs

Made of a Polyester acrylic fabric, this material has a rough grip for a secure tight fit.

Water Repellent and Stain Resistant.

Available in **Red**

Heat Shields

Our heat shields are there to protect your interior from the hot sun.

With these installed it will drastically lower the temperature of the helicopter which helps keep your upholstery from fading.

Available in **Silver. Reflective**

Winter Cover Kits

Our Winter Cover Kits include:

- Insulated Head & Engine Cover
- Main & Tail Rotor Covers
- Horizontal Stabilizer Covers
- Pitot Cover.

Comes inside a nylon bag for easy storage and is labeled with Part Numbers and Date for your records.

Available in Nylon **Red** and Tarp **Black** or **Silver**



ALLOUETE III BUBBLE COVER



AEROSPATALE ALLOUETE III COVERS

Part Number	Product Description	Set Price	Barcode Scan
HC-A3-223	Bubble Cover (All Windows)	\$770.00	
HC-A3-204	Engine Cover	\$650.00	
HC-A3-209	Engine Cover, INSULATED	\$1,000.00	
HC-A3-207	Head Cover	\$250.00	
HC-A3-210	Head Cover, INSULATED	\$350.00	

***All medium to large covers come with a medium-weight nylon bag for easy storage.



SA-315B LAMA COVER



SA-315B LAMA ROTOR COVER

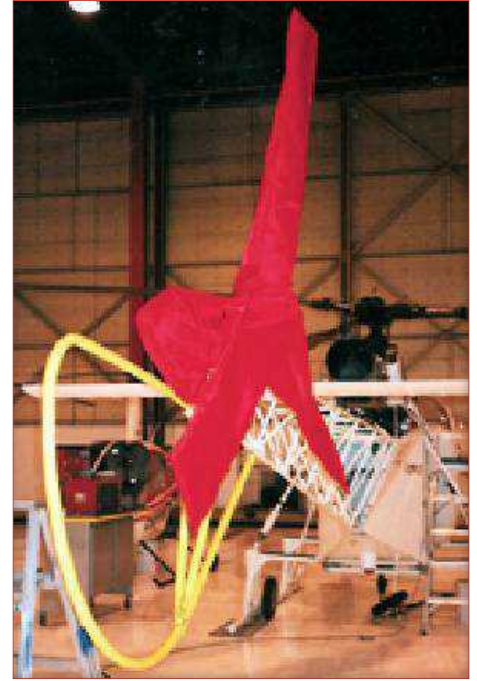

SA-315B LAMA COVERS

Part Number	Product Description	Set Price	Barcode Scan
HC-315-213	Blade Covers (3 per set), sold as set	\$510.00	
HC-315-213T	Blade Covers (3 per set), sold as set, TARP	\$540.00	
HC-315-214	Blade Tie Downs (3 per set), sold as set	\$240.00	
HC-315-201	Bubble Cover (All Windows)	\$865.00	
HC-315-204	Engine Cover	\$600.00	
HC-315-209	Engine Cover, INSULATED	\$850.00	
HC-315-207	Head Cover	\$275.00	
HC-315-210	Head Cover, INSULATED	\$375.00	
HC-315-219	Tail Rotor Blade Cover	\$250.00	
HC-315-219T	Tail Rotor Blade Cover, TARP	\$310.00	



SA-315B – LAMA TROOP SEATS

Seat covers are made of a Military Spec Nylon made to meet military standards. The material is very durable, breathable and stretches easily over the seat frame.

All materials meet FAR 29.853(a), comes with a Certification of Conformance and Burn Test Reports.a

Available in Grey

SA-315B LAMA TROOP SEAT COVERS



AEROSPATIALE SA-315B LAMA TROOP SEAT COVERS

Part Number	Product Description	Fits AC	Price	Barcode Scan
A-L315-101	Center One Place Seat (Grey)	SA315B Lama	\$200.00	
A-L315-102	Two Place Seat (Grey)	SA315B Lama	\$400.00	





AGUSTA WESTLAND



Helicopter Covers.....pg 16

Seat Belts.....pg 18

Upholstery Interiors.....pg 21





AGUSTA

Bubble / Window Covers

Made of our custom layered laminated material. The outside layer is made of a Nylon Codura which is water repellent, breathable and reflective. The inside layer is a soft inner lining. All engine and window covers are sewn on with a green (right side) and red (left side) indicator patches, for ease of installation.

Available in **Grey**

Main / Trail Rotor Blade Covers

Our blade covers are made of two different types of material:

Medium Weight Nylon - Recommended for Dry Cold Winters Areas

Heavy Weight Tarp - Recommended for Moist Rainy Areas

Available in Nylon **Red** and Tarp **Black** or **Silver**

Blade Tie-Downs / Intake Covers

All our blade tie-downs and intake covers are made of a Heavy-duty Polyester Scrim, all sewn on and secured with heavy duty nylon webbing or bungee hooks.

Available in **Red**

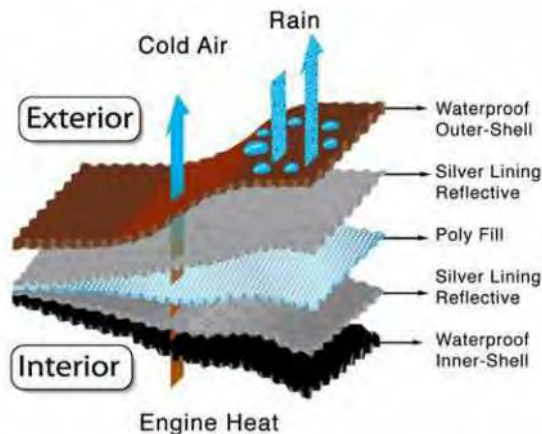

Insulated Covers

Being in Canada and having to experience very cold winter conditions, we know what it takes to keep your aircraft warm.

Through our vigorous R&D and years of experience we have come up with the best insulated covers in the industry.

Available in **Black** or **Red**

Engine / Exhaust Plugs

Made of a Polyester acrylic fabric, this material has a rough grip for a secure tight fit.

Water Repellent and Stain Resistant.

Available in **Red**

Heat Shields

Our heat shields are there to protect your interior from the hot sun.

With these installed it will drastically lower the temperature of the helicopter which helps keep your upholstery from fading.

Available in **Silver. Reflective**

Winter Cover Kits

Our Winter Cover Kits include:

- Insulated Head & Engine Cover
- Main & Tail Rotor Covers
- Horizontal Stabilizer Covers
- Pitot Cover.

Comes inside a nylon bag for easy storage and is labeled with Part Numbers and Date for your records.

Available in Nylon **Red** and Tarp **Black** or **Silver**



AGUSTA AW 109



AGUSTA AW109

Part Number	Product Description	Set Price	Barcode Scan
HC-A109-213	Blade Covers (4 per set), sold as set	\$500.00	
HC-A109-213	Blade Covers (4 per set), sold as set, TARP	\$765.00	
HC-A109-214	Blade Tie Down (4 per set), sold as set	\$200.00	
HC-A109-204	Engine Cover	\$550.00	
HC-A109-209	Engine Cover, INSULATED	\$760.00	
HC-A109-206	Exhaust Covers (3 per set), sold as set	\$230.00	
HC-A109-207	Head Cover	\$365.00	
HC-A109-210	Head Cover, INSULATED	\$550.00	
HC-A109-227	Heatshield Set, CABIN	\$220.00	
HC-A109-226	Heatshield Set, COCKPIT	\$220.00	
HC-A109-211	Intake Covers (2 per set), sold as set	\$150.00	
HC-A109-216	Pitot Cover (2 per set), sold as set	\$165.00	
HC-A109-208	Stabilizer Covers (2 per set), sold as set	\$450.00	
HC-A109-208T	Stabilizer Covers (2 per set), sold as set, TARP	\$525.00	
HC-A109-219	Tail Rotor Blade Cover	\$165.00	
HC-A109-219T	Tail Rotor Blade Cover, TARP	\$215.00	

***All medium to large covers come with a medium-weight nylon bag for easy storage.



AW109 – SEAT BELTS

All seat belts conform to either TSO C22g or C114 comes with complete certification. Since these are TSO approved parts depending on your Country's Air Regulation in most cases these belts can easily be swapped out with the originals. Please contact us for more information.

Available in a variety of different colors. Colors and reweb information can be seen on page 148-149



AGUSTA AW109 - SEAT BELTS

Part Number	Product Description	New Price	Reweb
73-68-00-30-15-00-810	Lap Belt (Hook-end fitting)	\$314.66	\$65.00
73-98-00-21-810-01	Shoulder Harness	\$526.27	\$80.00



AW119 – SEAT BELTS

All seat belts conform to either TSO C22g or C114 comes with complete certification. Since these are TSO approved parts depending on your Country's Air Regulation in most cases these belts can easily be swapped out with the originals. Please contact us for more information.

Available in a variety of different colors. Colors and reweb information can be seen on page 148-149



AGUSTA AW119 - SEAT BELTS

Part Number	Product Description	Set Price	Reweb
1-10-610201 rev A	Pilot and Co-Pilot	\$878.37	\$310.00
73-05-00-37-13-00-810	Passenger Lap Belt	\$314.66	\$65.00
73-98-00-21-810-01	Passenger Shoulder Harness	\$526.27	\$80.00



AW139 – SEAT BELTS

All seat belts conform to either TSO C22g or C114 comes with complete certification. Since these are TSO approved parts depending on your Country's Air Regulation in most cases these belts can easily be swapped out with the originals. Please contact us for more information.

Available in a variety of different colors. Colors and reweb information can be seen on page 148-149



AGUSTA AW139 - SEAT BELTS

Part Number	Product Description	Set Price	Reweb
1-10-705A01	Pilot and Co-Pilot	\$314.66	\$310.00
1-10-705A01	Passenger Restraint	\$526.27	\$310.00



AGUSTA WESTLAND - UPHOLSTERY

Aerotex Interiors specializes in the upholstery and re-furbishment of all helicopter seats and interiors. We offer all types of seat designs, seat cushions and material options. All our work and materials conform with necessary airworthiness regulations. With a flame test chamber in-house and an on call DAR we will be able to make proper arrangements for any type certification needed.

Seat designs and ideas can be viewed on page 150-152
 See pages 138-147 for materials samples.



AGUSTA WESTLAND - UPHOLSTERY

Part Number	Product Description	Price
NA	Upholstery Interiors	POR



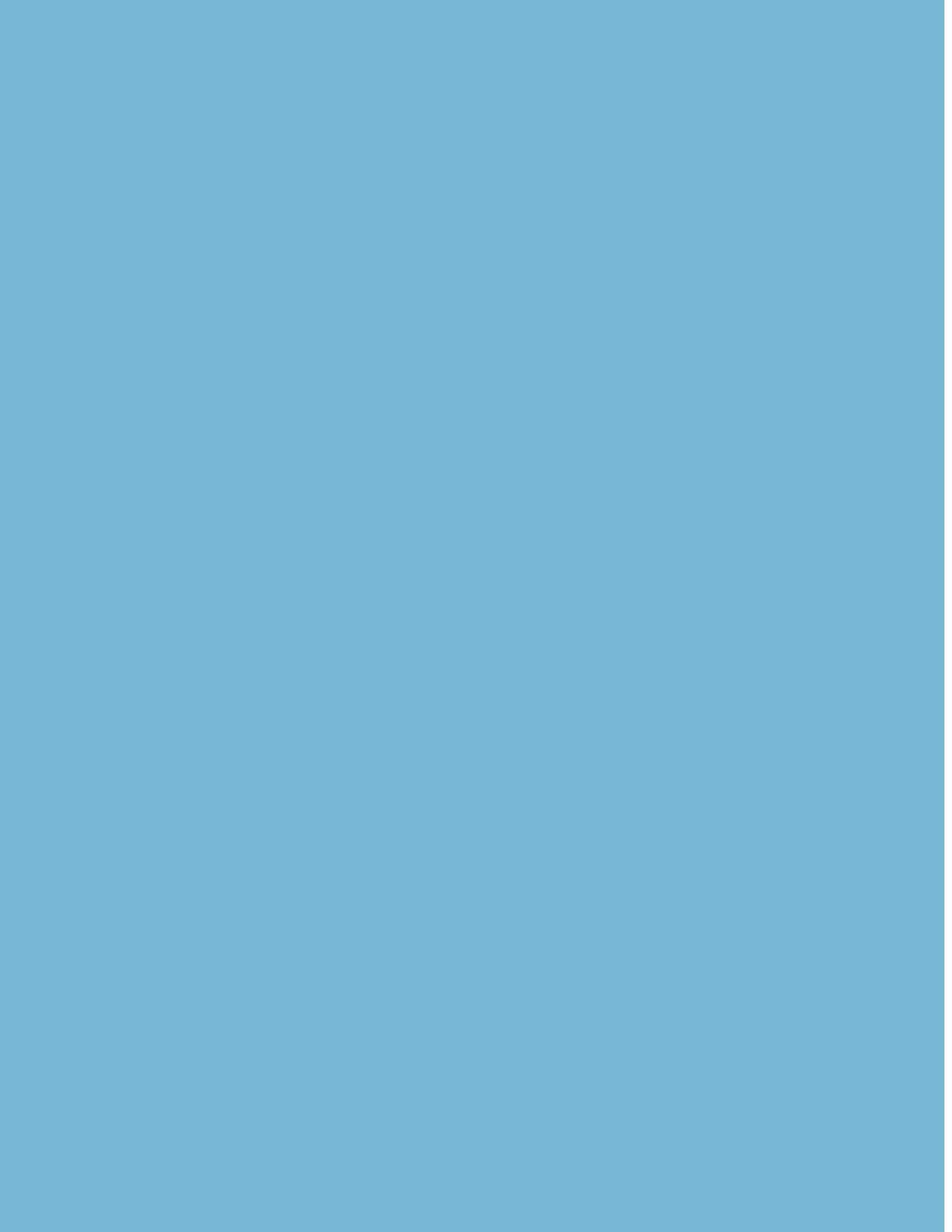

BELL LIGHT



Helicopter Covers.....pg 24

Boot Covers.....pg 30

Flooring.....pg 31

Seat Belts.....pg 32

Seats.....pg 35

Map Pouches & Misc.....pg 39





BELL – LIGHT

Bubble / Window Covers

Made of our custom layered laminated material. The outside layer is made of a Nylon Codura which is water repellent, breathable and reflective. The inside layer is a soft inner lining. All engine and window covers are sewn on with a green (right side) and red (left side) indicator patches, for ease of installation.

Available in **Grey**

Main / Trail Rotor Blade Covers

Our blade covers are made of two different types of material:

Medium Weight Nylon - Recommended for Dry Cold Winters Areas

Heavy Weight Tarp - Recommended for Moist Rainy Areas

Available in Nylon **Red** and **Tarp Black** or **Silver**

Blade Tie-Downs / Intake Covers

All our blade tie-downs and intake covers are made of a Heavy-duty Polyester Scrim, all sewn on and secured with heavy duty nylon webbing or bungee hooks.

Available in **Red**

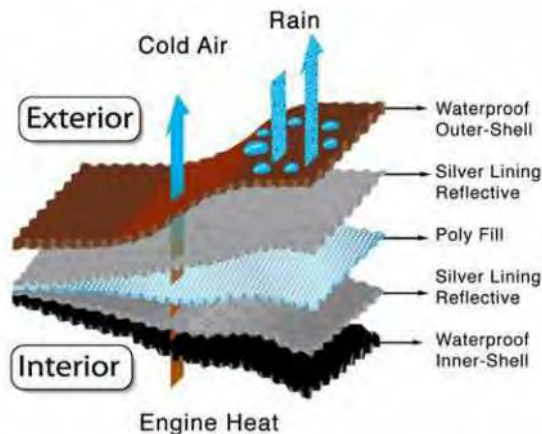

Insulated Covers

Being in Canada and having to experience very cold winter conditions, we know what it takes to keep your aircraft warm.

Through our vigorous R&D and years of experience we have come up with the best insulated covers in the industry.

Available in **Black** or **Red**

Engine / Exhaust Plugs

Made of a Polyester acrylic fabric, this material has a rough grip for a secure tight fit.

Water Repellent and Stain Resistant.

Available in **Red**

Heat Shields

Our heat shields are there to protect your interior from the hot sun.

With these installed it will drastically lower the temperature of the helicopter which helps keep your upholstery from fading.

Available in **Silver. Reflective**

Winter Cover Kits

Our Winter Cover Kits include:

- Insulated Head & Engine Cover
- Main & Tail Rotor Covers
- Horizontal Stabilizer Covers
- Pitot Cover.

Comes inside a nylon bag for easy storage and is labeled with Part Numbers and Date for your records.

Available in Nylon **Red** and **Tarp Black** or **Silver**



BELL 206L/407 INTAKE COVER



BELL LIGHT WINDSHIELD COVER



BELL LIGHT WINDSHIELD COVER



BELL 206L INSULATED ENGINE COVER



BELL 206B INSULATED ENGINE COVER



MAIN ROTOR BLADE TIE DOWN

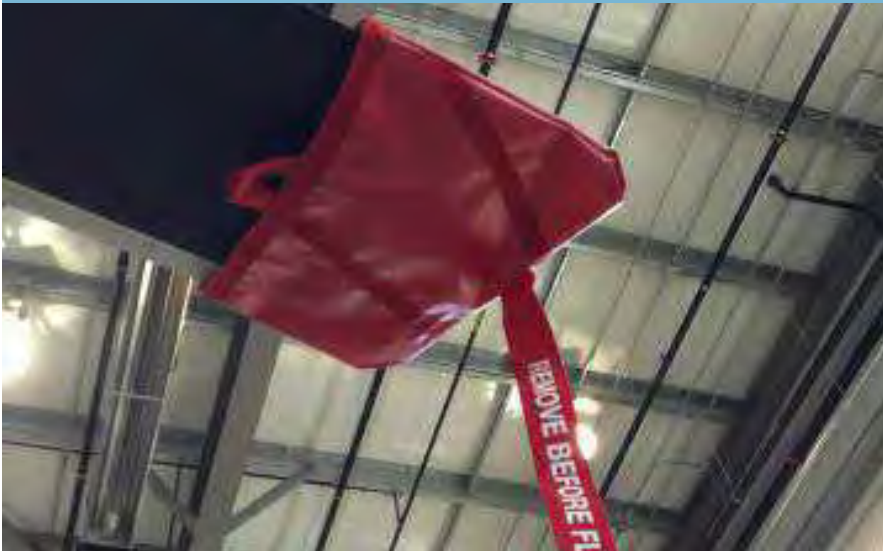

MED-LRG COVERS COME WITH BAGS



BELL 206B - HELICOPTER COVERS



WINTER COVERS FOR BELL 206B

BELL 206B

Part Number	Product Description	Set Price	Barcode Scan
HC-206B-213	Blade Covers (2 per set), sold as set	\$300.00	
HC-206B-213T	Blade Covers (2 per set), sold as set, TARP	\$330.00	
HC-206B-214	Blade Tie Downs (2 per set), sold as set	\$200.00	
HC-206B-204	Engine Cover	\$475.00	
HC-206B-209	Engine Cover, INSULATED	\$750.00	
HC-206B-205	Exhaust Covers (2 per set), sold as set	\$130.00	
HC-206B-207	Head Cover	\$175.00	
HC-206B-210	Head Cover, INSULATED	\$275.00	
HC-206B-227	Heatshield Set, CABIN	\$230.00	
HC-206B-226	Heatshield Set, COCKPIT	\$290.00	
HC-206B-212	Intake Plugs (4 per set), sold as set	\$250.00	
HC-206B-216	Pitot Cover	\$25.00	
HC-206B-208	Stabilizer Covers (2 per set), sold as set	\$250.00	
HC-206B-215	Stabilizer Covers (2 per set), sold as set, PADDED	\$400.00	
HC-206B-208T	Stabilizer Covers (2 per set), sold as set, TARP	\$310.00	
HC-206B-219	Tail Rotor Blade Cover	\$125.00	
HC-206B-219T	Tail Rotor Blade Cover, TARP	\$160.00	
HC-206B-220	Tail Rotor Blade Tie Down	\$65.00	
HC-206B-224	Windshield Cover	\$450.00	
HC-206B-300	Winter Cover Kit (Standard Blade Covers)	\$1,725.00	
HC-206B-300T	Winter Cover Kit (Tarp Blade Covers)	\$1,850.00	

***All medium to large covers come with a medium-weight nylon bag for easy storage.



BELL 206L - HELICOPTER COVERS



WINTER COVERS FOR BELL 206L

BELL 206L

Part Number	Product Description	Set Price	Barcode Scan
HC-206L-213	Blade Covers (2 per set), sold as set	\$410.00	
HC-206L-213T	Blade Covers (2 per set), sold as set TARP	\$460.00	
HC-206L-214	Blade Tie Downs (2 per set), sold as set	\$200.00	
HC-206L-223	Bubble Cover (All Windows)	\$750.00	
HC-206L-204	Engine Cover	\$525.00	
HC-206L-209	Engine Cover, INSULATED	\$745.00	
HC-206L3-205	Exhaust Cover (L3/L4)	\$105.00	
HC-206L-205	Exhaust Covers (2 per set), sold as set	\$130.00	
HC-206L-207	Head Cover	\$175.00	
HC-206L-210	Head Cover, INSULATED	\$275.00	
HC-206L-227	Heatshield Set, CABIN	\$200.00	
HC-206L-226	Heatshield Set, COCKPIT	\$440.00	
HC-206L-212	Intake Plugs(2 per set), sold as set	\$170.00	
HC-206L-216	Pitot Cover	\$25.00	
HC-206L-208	Stabilizer Covers (2 per set), sold as set	\$290.00	
HC-206L-208T	Stabilizer Covers (2 per set), sold as set, TARP	\$360.00	
HC-206L-219	Tail Rotor Blade Cover	\$125.00	
HC-206L-219T	Tail Rotor Blade Cover, TARP	\$160.00	
HC-206L-220	Tail Rotor Blade Tie Down	\$65.00	
HC-206L-224	Windshield Cover	\$450.00	
HC-206L-300	Winter Cover Kit (Standard Blade Covers)	\$1,870.00	
HC-206L-300T	Winter Cover Kit (Tarp Blade Covers)	\$2,025.00	

***All medium to large covers come with a medium-weight nylon bag for easy storage.



BELL 407 - HELICOPTER COVERS



WINTER COVERS FOR BELL 407

BELL 407

Part Number	Product Description	Set Price	Barcode Scan
HC-407-213	Blade Covers (4 per set), sold as set	\$745.00	
HC-407-213T	Blade Covers (4 per set), sold as set, TARP	\$965.00	
HC-407-214	Blade Tie Down (4 per set), sold as set, MESH	\$710.00	
HC-407-223	Bubble Cover (All Windows)	\$750.00	
HC-407-204	Engine Cover	\$525.00	
HC-407-209	Engine Cover, INSULATED	\$745.00	
HC-407-205	Exhaust Cover (L3/L4)	\$105.00	
HC-407-207	Head Cover	\$420.00	
HC-407-210	Head Cover, INSULATED	\$550.00	
HC-407-227	Heatshield Set, CABIN	\$200.00	
HC-407-226	Heatshield Set, COCKPIT	\$440.00	
HC-407-212	Intake Plug	\$165.00	
HC-407-216	Pitot Cover	\$25.00	
HC-407-208	Stabilizer Covers (2 per set), sold as set	\$285.00	
HC-407-208T	Stabilizer Covers (2 per set), sold as set, TARP	\$310.00	
HC-407-219	Tail Rotor Blade Cover	\$125.00	
HC-407-219T	Tail Rotor Blade Cover, TARP	\$160.00	
HC-407-220	Tail Rotor Blade Tie Down	\$65.00	
HC-407-224	Windshield Cover	\$450.00	
HC-407-300	Winter Cover Kit (Standard Blade Covers)	\$2,475.00	
HC-407-300T	Winter Cover Kit (Tarp Blade Covers)	\$2,755.00	

***All medium to large covers come with a medium-weight nylon bag for easy storage.



BELL LIGHT – 206B / 206L / 407 BOOT COVERS

Boot covers are made of a FAR vinyl, with military spec snaps.

All materials meet FAR 29.853(a), comes with a Certification of Conformance and Burn Test Reports.



BELL LIGHT – BOOT COVERS

Part Number	Product Description	Set Price	Barcode Scan
A-406-101-103	Collective Boot Cover (Black) (SN 53000 thru 53063)		
A-406-101-101	Collective Boot Cover (Black) (SN 53000 thru 53063) Replaced By 406-001-101-103		
A-206-214-101	Collective Boot Cover (Black) Snaps		
A-206-017-025	Collective Boot Cover (Black) Zipper		
A-206-017-105	Collective Boot Cover (Black) Zipper		
A-206-361-019	Cyclic Boot Cover (Black)		
A-206-361-045	Cyclic Boot Cover (Black)		
A-206-361-103	Cyclic Boot Cover (Black)		
A-206-361-039	Cyclic Boot Cover (Black)		
A-206-065-103	LH Cyclic Boot Cover (Black)		
A-206-066-105	RH Cyclic Boot Cover (Black)		



BELL LIGHT – 206B / 206L / 407 FLOORING KITS

We offer three types of flooring options (Standard Nylon Carpet, Utility Carpet and Coin Dot Flooring). Velcro is sewn on the bottom of the carpet. Prices are shown for Standard Nylon Carpet. Prices for Utility Carpet and Coin Dot are 1.25x the price below. Just add the prefix -UC for Utility Carpet and -CD for Coin Dot next to the Part Number when ordering. Please send us pictures or the original carpets to make of proper fitment.

All materials meet FAR 29.853(a), comes with a Certification of Conformance and Burn Test Reports.

Carpet and Flooring Samples are on page



BELL LIGHT – FLOORING KITS

Part Number	Product Description	Set Price	Barcode Scan
A-407-201	Carpet Kit	\$1,150.00	
A-206B-203	Carpet Kit (SN 1164 thru 3566)	\$1,150.00	
A-206B-201	Carpet Kit (SN 4 thru 1163)	\$1,150.00	
A-206L-201	Carpet Kit (SN 45004 thru SUB, 446601 thru SUB)	\$1,150.00	
A-206L-202	Carpet Kit (SN 51001 thru SUB, 52001 thru SUB)	\$1,150.00	



BELL LIGHT 206B SEAT BELTS

All seat belts conform to either TSO C22g or C114 comes with complete certification. Since these are TSO approved parts depending on your Country's Air Regulation in most cases these belts can easily be swapped out with the originals. Please contact us for more information.

Available in a variety of different colors. Colors and reweb information can be seen on page 148-149



BELL 206B SEAT BELTS

Part Number	Product Description	New Price	Reweb Price	Barcode Scan
PME282858-BQ-010	Crew Belts	\$911.28	\$185	
FME481050-BQ-010	FWD Facing Seats (left and right)	\$816.92	\$150	
FME481060-BQ-010	FWD Facing Seat (center position)	\$816.92	\$150	
NBE18-010	Extension Belt (optional)	\$68.34	\$50	



BELL LIGHT 206L SEAT BELTS

All seat belts conform to either TSO C22g or C114 comes with complete certification. Since these are TSO approved parts depending on your Country's Air Regulation in most cases these belts can easily be swapped out with the originals. Please contact us for more information.

Available in a variety of different colors. Colors and reweb information can be seen on page 148-149



BELL 206L SEAT BELTS

Part Number	Product Description	New Price	Reweb Price	Barcode Scan
PME282858-BQ-010	Crew Belts	\$911.28	\$185	
FME481060-BP-010	AFT Facing Pax Seats	\$1,114.45	\$150	
FME481050-BQ-010	FWD Facing Seats (left and right)	\$816.92	\$150	
FME481060-BQ-010	FWD Facing (center position)	\$816.92	\$150	
NBE18-010	Extension Belt (optional)	\$68.34	\$50	



BELL LIGHT 407 SEAT BELTS

All seat belts conform to either TSO C22g or C114 comes with complete certification. Since these are TSO approved parts depending on your Country's Air Regulation in most cases these belts can easily be swapped out with the originals. Please contact us for more information.

Available in a variety of different colors. Colors and reweb information can be seen on page 148-149

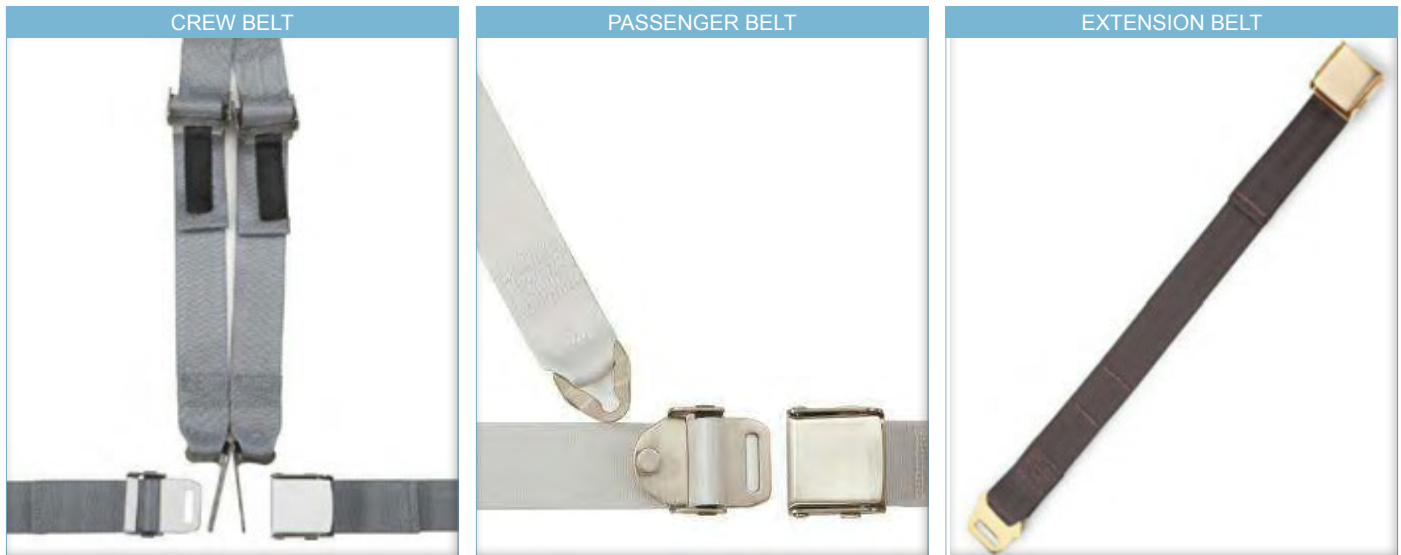

BELL LIGHT 407 SEAT BELTS

Part Number	Product Description	Set Price	Set Price	Barcode Scan
PME282858-BY-010	Crew belts	\$1,205.96	\$185	
FME481060-BW-010	AFT Facing Passenger Seats	\$1,111.96	\$150	
FME481050-BW-010	FWD Facing Seats (left and right)	\$1,111.96	\$150	
FME481060-BW-010	FWD Facing Seat (center position)	\$1,111.96	\$150	
NBE18-010	Extension Belt (optional)	\$68.34	\$50	



BELL 206B CREW SEATS



BELL 206B PASSENGER SEATS



BELL 206B CREW SEATS



BELL 407 CREW SEATS



BELL 407 AFT FACING PASSENGER SEATS



BELL 407 FWD FACING PASSENGER SEATS



BELL LIGHT 206B / 206L / 407 SEAT REFURBISHMENT

Aerotex Interiors specializes in the upholstery and re-furbishment of all helicopter seats and interiors. We offer all types of seat designs, seat cushions and material options. All our work and materials conform with necessary airworthiness regulations. With a flame test chamber in-house and an on call DAR we will be able to make proper arrangements for any type certification needed.

Seat designs and ideas can be viewed on pages 150-152
 See pages 138-147 for material samples

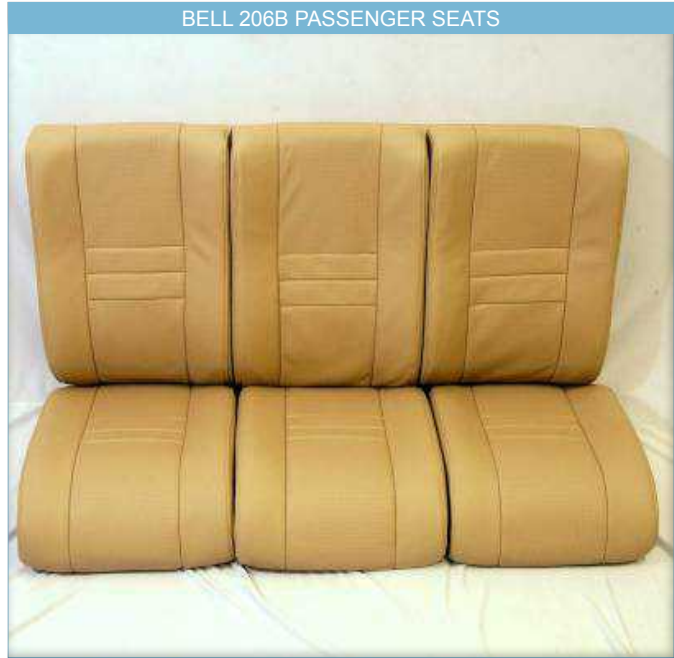
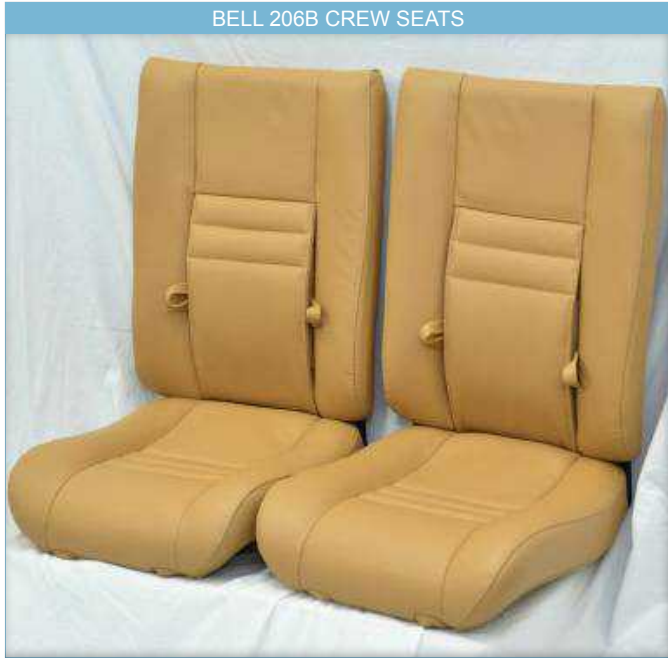

BELL LIGHT 206B / 206L / 407 SEAT REFURBISHMENT

Part Number	Product Description	Set Price	Barcode Scan
A-206B-102	Complete Seat Refurbishment (new seat webbing, foam cushions and fabric/vinyl seat covers) per seat	POR	
A-206L-102	Complete Seat Refurbishment (new seat webbing, foam cushions and fabric/vinyl seat covers) per seat	POR	
A-407-102	Complete Seat Refurbishment (new seat webbing, foam cushions and fabric/vinyl seat covers) per seat	POR	



BELL LIGHT – 206B / 206L / 407 SEAT DUST COVERS

Aerotex Seat Dust Covers are designed to help protect your upholstery. These are very popular in the Fire Fighting, Forestry and Drilling Industry. As all seat cushions are different shapes and sizes, please send us pictures or the original seats to make sure we get a good fit..

Custom Logo Embroidery is Available. \$125 One-Time Setup Cost + \$35 per Embroidery.

Canvas and Nylon Material Samples can be viewed on page 146-147



BELL LIGHT – 206B / 206L / 407 SEAT DUST COVERS

Part Number	Product Description	Set Price	Barcode Scan
A-206L-310	Seat Dust Cover Set (6-Man Seat Config, Narrow Middle AFT Seat)	\$1,050.00	
A-206L-300	Seat Dust Cover Set (7-Man Seat Config)	\$1,050.00	
A-206B-340	Seat Dust Cover Set (High Back Crew Seats, 2-Place Attached Back Cabin Back Seat Config)	\$750.00	
A-206B-330	Seat Dust Cover Set (High Back Crew Seats, 3-Place Attached Back Cabin Back Seat Config)	\$750.00	
A-206B-350	Seat Dust Cover Set (High Back Crew Seats, 3x Single Cabin Seat Config)	\$750.00	
A-206L-330	Seat Dust Cover Set (Hinged Seat Back and Bottom, 6-Man Seat Config, Narrow Middle AFT Seat)	\$1,125.00	
A-206L-320	Seat Dust Cover Set (Hinged Seat Back and Bottom, 7-Man Seat Config)	\$1,125.00	
A-206B-310	Seat Dust Cover Set (Low Back Crew Seats, 2-Place Attached Back Cabin Back Seat Config)	\$750.00	
A-206B-300	Seat Dust Cover Set (Low Back Crew Seats, 3-Place Attached Back Cabin Back Seat Config)	\$750.00	
A-206B-320	Seat Dust Cover Set (Low Back Crew Seats, 3x Single Cabin Seat Config)	\$750.00	
A-407-310	Seat Dust Cover Set (New Style Hinged Seat Back and Bottom, 6-Man Seat Config, Narrow Middle AFT Seat)	\$1,125.00	
A-407-300	Seat Dust Cover Set (New Style Hinged Seat Back and Bottom, 7-Man Seat Config)	\$1,125.00	
A-206B-360	Seat Dust Cover Set (New Style Hinged Seat Back and Bottom)	\$850.00	



BELL LIGHT – MAP POUCHES & POCKETS

Our Pockets and Map Pouches allow for extra storage of documents. Made of FAR approved vinyl. Can be made with a clear plastic window if requested.

Vinyl Samples can be viewed on page 140

GREY SMALL MAP POUCH



BLACK CENTER POCKET



BLACK SMALL MAP POUCH



BELL LIGHT – MAP POUCHES AND POCKETS

Part Number	Product Description	Set Price	Barcode Scan
A-206-658-001	Center Map Pocket Assy.	\$172.50	
A-206-658-002	Small Map Pouch	\$46.00	





BELL MEDIUM



Helicopter Covers.....pg 42

Boot Covers.....pg 40

Seat Belts.....pg 46

Crew Seats.....pg 47

Passenger Seats.....pg 57

Wall Blankets.....pg 62

Cargo Nets.....pg 70

Map Pouches & Misc.....pg 71





BELL MEDIUM – HELICOPTER COVERS

Bubble / Window Covers

Made of our custom layered laminated material. The outside layer is made of a Nylon Codura which is water repellent, breathable and reflective. The inside layer is a soft inner lining. All engine and window covers are sewn on with a green (right side) and red (left side) indicator patches, for ease of installation.

Available in **Grey**

Main / Trail Rotor Blade Covers

Our blade covers are made of two different types of material:

Medium Weight Nylon - Recommended for Dry Cold Winters Areas

Heavy Weight Tarp - Recommended for Moist Rainy Areas

Available in Nylon **Red** and **Tarp Black** or **Silver**

Blade Tie-Downs / Intake Covers

All our blade tie-downs and intake covers are made of a Heavy-duty Polyester Scrim, all sewn on and secured with heavy duty nylon webbing or bungee hooks.

Available in **Red**

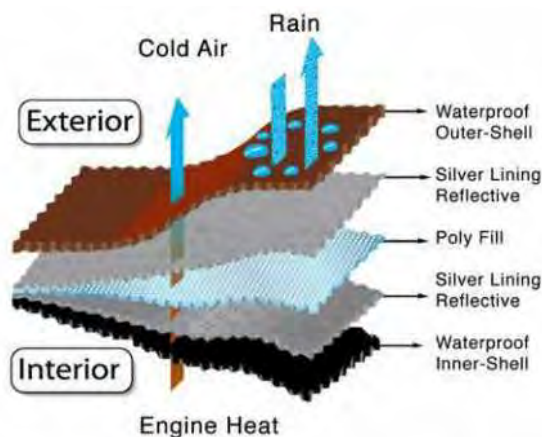

Insulated Covers

Being in Canada and having to experience very cold winter conditions, we know what it takes to keep your aircraft warm.

Through our vigorous R&D and years of experience we have come up with the best insulated covers in the industry.

Available in **Black** or **Red**

Engine / Exhaust Plugs

Made of a Polyester acrylic fabric, this material has a rough grip for a secure tight fit.

Water Repellent and Stain Resistant.

Available in **Red**

Heat Shields

Our heat shields are there to protect your interior from the hot sun.

With these installed it will drastically lower the temperature of the helicopter which helps keep your upholstery from fading.

Available in **Silver. Reflective**

Winter Cover Kits

Our Winter Cover Kits include:

- Insulated Head & Engine Cover
- Main & Tail Rotor Covers
- Horizontal Stabilizer Covers
- Pitot Cover.

Comes inside a nylon bag for easy storage and is labeled with Part Numbers and Date for your records.

Available in Nylon **Red** and **Tarp Black** or **Silver**



BELL 204 - HELICOPTER COVERS



BELL 204



WINTER COVERS FOR BELL 204

BELL MEDIUM 204 (UH-1B) COVERS

Part Number	Product Description	Set Price	Barcode Scan
HC-204-228	Avionics Nose Cover	\$300.00	
HC-204-213	Blade Covers (2 per set), sold as set	\$500.00	
HC-204-213T	Blade Covers (2 per set), sold as set, TARP	\$550.00	
HC-204-214	Blade Tie Downs (2 per set), sold as set	\$300.00	
HC-204-204	Engine Cover	\$650.00	
HC-204-209	Engine Cover, INSULATED	\$950.00	
HC-204-205	Exhaust Cover	\$120.00	
HC-204-207	Head Cover	\$285.00	
HC-204-210	Head Cover, INSULATED	\$385.00	
HC-204-212	Intake Plug	\$250.00	
HC-204-216	Pitot Covers (2 per set), sold as set	\$120.00	
HC-204-208	Stabilizer Covers (2 per set), sold as set	\$250.00	
HC-204-215	Stabilizer Covers (2 per set), sold as set, PADDED	\$400.00	
HC-204-208T	Stabilizer Covers (2 per set), sold as set, TARP	\$310.00	
HC-204-219	Tail Rotor Blade Cover	\$185.00	
HC-204-219T	Tail Rotor Blade Cover, TARP	\$240.00	
HC-204-220	Tail Rotor Tie Down	\$100.00	
HC-204-226	Window Plug	\$200.00	
HC-204-225	Windshield Cover	\$450.00	
HC-204-300	Winter Cover Kit (Standard Blade Covers)	\$2,205.00	
HC-204-300T	Winter Cover Kit (Tarp Blade Covers)	\$2,315.00	

***All medium to large covers come with a medium-weight nylon bag for easy storage.



Bell Medium | Helicopter Covers

BELL 205 – HELICOPTER COVERS

BELL 205 WINTER COVER KIT



BELL MEDIUM WINDOW COVER



BELL 205 INSUATED ENGINE/HEAD COVER



MED-LRG COVERS COME WITH BAGS



BELL 205 (UH-1H) COVERS

Part Number	Product Description	Set Price	Barcode Scan
HC-205-228	Avionics Battery Nose Cover	\$300.00	
HC-205-213	Blade Covers (2 per set), sold as set	\$500.00	
HC-205-213T	Blade Covers (2 per set), sold as set, TARP	\$550.00	
HC-205-214	Blade Tie Downs (2 per set), sold as set	\$300.00	
HC-205-204	Engine Cover	\$650.00	
HC-205-209	Engine Cover, INSULATED	\$950.00	
HC-205-217	Engine/Main Body Cover	\$800.00	
HC-205-227	Engine/Main Body Cover, INSULATED	\$800.00	
HC-205-205	Exhaust Cover	\$120.00	
HC-205-223	FWD Cabin Window Cover	\$650.00	
HC-205-207	Head Cover	\$285.00	
HC-205-210	Head Cover, INSULATED	\$385.00	
HC-205-227	Heatshield Set, CABIN	\$600.00	
HC-205-226	Heatshield Set, COCKPIT	\$600.00	
HC-205-211	Intake Cover	\$235.00	
HC-205-211A	Intake Cover (ASF)	\$235.00	
HC-205-216	Pitot Covers (2 per set), sold as set	\$120.00	
HC-205-208	Stabilizer Covers (2 per set), sold as set	\$250.00	
HC-205-215	Stabilizer Covers (2 per set), sold as set, PADDED	\$400.00	
HC-205-208T	Stabilizer Covers (2 per set), sold as set, TARP	\$310.00	
HC-205-219	Tail Rotor Blade Cover	\$185.00	
HC-205-219T	Tail Rotor Blade Cover, TARP	\$240.00	
HC-205-220	Tail Rotor Tie Down	\$100.00	
HC-205-225	Window Plug	\$200.00	
HC-205-224	Windshield Cover	\$450.00	
HC-205-300	Winter Cover Kit (Standard Blade Covers)	\$2,390.00	
HC-205-300T	Winter Cover Kit (Tarp Blade Covers)	\$2,555.00	



BELL 212 - HELICOPTER COVERS

BELL 212 WINTER COVER KIT



BELL MEDIUM WINDOW COVER

































BELL 412 INSULATED ENGINE/HEAD COVER



MED-LRG COVERS COME WITH BAGS



BELL 212 COVERS

Part Number	Product Description	Set Price	Barcode Scan
HC-212-228	Avionics Nose Cover	\$300.00	
HC-212-213	Blade Covers (2 per set), sold as set	\$500.00	
HC-212-213T	Blade Covers (2 per set), sold as set, TARP	\$550.00	
HC-212-214	Blade Tie Downs (2 per set), sold as set	\$300.00	
HC-212-204	Engine Cover	\$775.00	
HC-212-209	Engine Cover, INSULATED	\$1,100.00	
HC-212-205	Exhaust Covers (2 per set), sold as set	\$220.00	
HC-212-206	Exhaust Plugs (2 per set), sold as set	\$250.00	
HC-212-206A	Exhaust Plugs (Alpine Mod) (2 per set), sold as set	\$300.00	
HC-212-223	FWD Cabin Window Cover	\$650.00	
HC-212-207	Head Cover	\$285.00	
HC-212-210	Head Cover, INSULATED	\$385.00	
HC-212-227	Heatshield Set, CABIN	\$600.00	
HC-212-226	Heatshield Set, COCKPIT	\$600.00	
HC-212-212L	Intake Plugs (L/H)	\$290.00	
HC-212-212R	Intake Plugs (R/H)	\$290.00	
HC-212-203L	Oil Cooler Inlet Plugs (L/H)	\$220.00	
HC-212-203R	Oil Cooler Inlet Plugs (R/H))	\$220.00	
HC-212-216	Pitot Covers (2 per set), sold as set	\$120.00	
HC-212-228	Plenum Plugs (set of 2)	\$400.00	
HC-212-208	Stabilizer Covers (2 per set), sold as set	\$250.00	
HC-212-215	Stabilizer Covers (2 per set), sold as set, PADDED	\$400.00	
HC-212-208T	Stabilizer Covers (2 per set), sold as set, TARP	\$310.00	
HC-212-219	Static Wick Protector (set of 2)	\$200.00	
HC-212-219	Tail Rotor Blade Cover	\$185.00	
HC-212-219T	Tail Rotor Blade Cover, TARP	\$240.00	
HC-212-220	Tail Rotor Tie Down	\$100.00	
HC-212-225	Window Plug	\$200.00	
HC-212-224	Windshield Cover	\$450.00	
HC-212-300	Winter Cover Kit (Standard Blade Covers)	\$2,440.00	
HC-212-300T	Winter Cover Kit (Tarp Blade Covers)	\$2,705.00	



Bell Medium | Helicopter Covers

BELL 412 – HELICOPTER COVERS

BELL 412 WINTER COVER KIT



BELL MEDIUM WINDOW COVER



BELL 412 INSULATED ENGINE/HEAD COVER



MED-LRG COVERS COME WITH BAGS



BELL 412/412CF/CH-146 COVERS

Part Number	Product Description	Set Price	Barcode Scan
HC-412-228	Avionics Nose Cover	\$300.00	
HC-412CF-BC	Blade Cover/Tiedown (4 per set), sold as set, TARP	\$2,780.00	
HC-412-213	Blade Covers (4 per set), sold as set	\$1,420.00	
HC-412-213T	Blade Covers (4 per set), sold as set, TARP	\$1,860.00	
HC-412-214	Blade Tie Down (4 per set), sold as set, MESH	\$800.00	
HC-412-204	Engine Cover	\$1,150.00	
HC-412-209	Engine Cover, INSULATED	\$2,250.00	
HC-412-205	Exhaust Covers (2 per set), sold as set	\$220.00	
HC-412-206	Exhaust Plugs (2 per set), sold as set	\$250.00	
HC-412-206A	Exhaust Plugs (Alpine Mod) (2 per set), sold as set	\$300.00	
HC-412-223	FWD Cabin Window Cover	\$650.00	
HC-412-207	Head Cover	\$750.00	
HC-412-210	Head Cover, INSULATED	\$1,050.00	
HC-412-227	Heatshield Set, CABIN	\$600.00	
HC-412-226	Heatshield Set, COCKPIT	\$600.00	
HC-412-212L	Intake Plugs (L/H)	\$290.00	
HC-412-212R	Intake Plugs (R/H)	\$290.00	
HC-412-203L	Oil Cooler Inlet Plugs (L/H)	\$220.00	
HC-412-203R	Oil Cooler Inlet Plugs (R/H))	\$220.00	
HC-412CF-216	Pitot Cover with Hook Bungee, (2 per set) sold as set	\$200.00	
HC-412-216	Pitot Covers (2 per set), sold as set	\$120.00	
HC-412-228	Plenum Plugs (set of 2)	\$400.00	
HC-412-208	Stabilizer Covers (2 per set), sold as set	\$250.00	
HC-412-208T	Stabilizer Covers (2 per set), sold as set, TARP	\$310.00	
HC-412-219	Static Wick Protector (set of 2)	\$200.00	
HC-412-219	Tail Rotor Blade Cover	\$185.00	
HC-412-219T	Tail Rotor Blade Cover, TARP	\$240.00	
HC-412-220	Tail Rotor Tie Down	\$100.00	
HC-412-300	Winter Cover Kit (Standard Blade Covers)	\$4,280.00	
HC-412-300T	Winter Cover Kit (Tarp Blade Covers)	\$3,160.00	



BELL MEDIUM – BOOT COVERS

Boot covers are made of a heavy-duty vinyl, with military spec webbing and snaps to secure on to Helicopter.

All materials meet FAR 29.853(a), comes with a Certification of Conformance and Burn Test Reports.

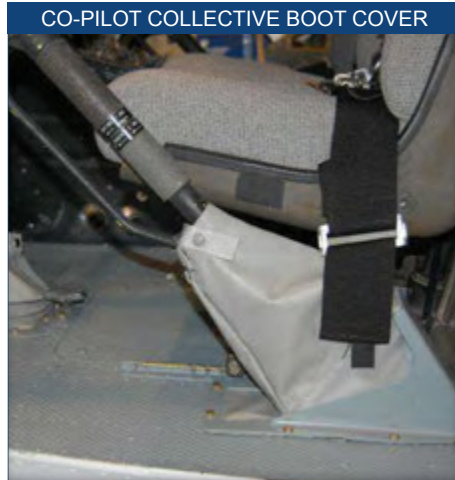
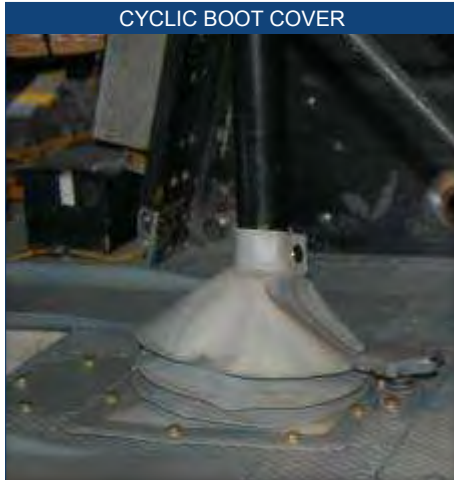

BELL MEDIUM – BOOT COVERS

Part Number	Product Description	Set Price	Barcode Scan
A-204-306-105B	Co-Pilot Collective Boot Cover (Black)**	\$195.00	
A-204-306-105G	Co-Pilot Collective Boot Cover (Grey)**	\$195.00	
A-204-328-101B	Cyclic Boot Cover (Black)**	\$300.00	
A-204-328-101G	Cyclic Boot Cover (Grey)**	\$300.00	
A-204-306-101B	Pilot Collective Boot Cover (Black)**	\$250.00	
A-204-306-103B	Pilot Collective Boot Cover (Black)**	\$250.00	
A-204-306-101G	Pilot Collective Boot Cover (Grey)**	\$250.00	
A-204-306-103G	Pilot Collective Boot Cover (Grey)**	\$250.00	



BELL MEDIUM – 212 / 412 SEAT BELTS

All seat belts conform to either TSO C22g or C114 comes with complete certification. Since these are TSO approved parts depending on your Country's Air Regulation in most cases these belts can easily be swapped out with the originals. Please contact us for more information.

Available in a variety of different colors. Colors and reweb information can be seen on page 148-149



BELL MEDIUM – 212/412 SEAT BELTS

Part Number	Product Description	Set Price	Barcode Scan
A-FDC-6400-532	Seat Belt	\$75.00	
MDE1640-B-010	Passenger Belt	\$94.32	
SAKB16055500-0EVA-010	Crew Belt	\$1170.00	



BELL MEDIUM – 204 / 205 CREW SEATS CUSHIONS

Bell 204/205 Crew Seat Cushions are made of high quality FAR grade foam and our standard Aerotex Fabric with an abrasion resistance of 250,000 double rubs.

Custom Logo Embroidery is Available. \$125 One-Time Setup Cost + \$35 per Embroidery

All materials meet FAR 29.853(a), comes with a Certification of Conformance and Burn Test Reports

Pricing is shown for Standard Fabric. Available in other fabrics, vinyl, leather sheepskin please contact us for pricing. See pages 138-145 for color samples



BELL MEDIUM – 204 / 205 CREW SEAT CUSHIONS

Part Number	Product Description	Set Price	Barcode Scan
A-204-785-001	Crew Seat Back Cushion	\$400.00	
A-204-784-001	Crew Seat Bottom Cushion	\$450.00	
A-204-784-001A	Crew Seat Cushion Assy.	\$950.00	
A-204-784-001D	Crew Seat Dust Cover *Protects Upholstery*	\$190.00	



BELL MEDIUM – 212 / 412 CREW SEATS

Bell 212/412 Crew Seat Cushions are made of high quality FAR grade foam

Custom Logo Embroidery is Available. \$125 One-Time Setup Cost + \$35 per Embroidery

All materials meet FAR 29.853(a), comes with a Certification of Conformance and Burn Test Reports. STC Approved

Pricing is shown for Standard Fabric. Available in other fabrics, vinyl, leather sheepskin please contact us for pricing. See pages 138-147 for color samples



BELL MEDIUM – 212 / 214 CREW SEATS

Part Number	Product Description	Set Price	Barcode Scan
A-412-819-101Z	Crew Seat Back Cushion	\$1,265.00	
A-412-819-101	Crew Seat Back Cushion	\$1,265.00	
A-412-820-101	Crew Seat Bottom Cushion	\$1,265.00	
A-412-820-103	Crew Seat Bottom Cushion	\$1,265.00	
A-412-820-103Z	Crew Seat Bottom Cushion	\$1,265.00	
A-212-126-107G	Life Vest Pocket (Grey)	\$85.00	
A-212-126-107R	Life Vest Pocket (Red)	\$85.00	



BELL MEDIUM – CREW MESH SEATS

Skyline Mesh Seat Covers are made of heavy-duty mesh and long lasting FAR canvas material. The Foam supports are graphite and made with high-density foam.

Custom Logo Embroidery is Available on Dust Cover. \$125 One-Time Setup Cost + \$35 per Embroidery

All materials meet FAR 29.853(a), comes with a Certification of Conformance and Burn Test Reports.

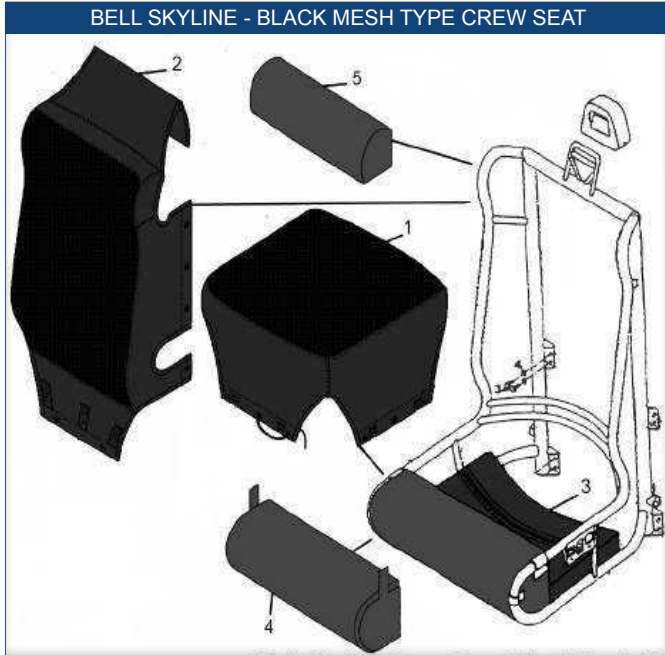

BELL MEDIUM – SKYLINE MESH SEATS

Part Number	Product Description	Set Price	Barcode Scan
A-205-070-798-113B	Crew Mesh Seat Back Cover (Black)	\$350.00	
A-205-070-798-113R	Crew Mesh Seat Back Cover (Red)	\$350.00	
A-205-070-798-111B	Crew Mesh Seat Bottom Cover (Black)	\$350.00	
A-205-070-798-111R	Crew Mesh Seat Bottom Cover (Red)	\$350.00	
A-AL1021-1200A	Crew Seat Top Back Pad	\$75.00	
A-SK1018-8-00	Front Bottom Pad	\$135.00	
A-SK1018-8-00C	Front Bottom Pad (Comfort)	\$169.00	
A-SK1018-8-01B	Seat Bottom Pad (Black)	\$275.00	
A-SK1018-8-01R	Seat Bottom Pad (Red)	\$275.00	



BELL MEDIUM - CREW DUST COVER



BELL MEDIUM - CREW DUST COVER



BELL SKYLINE - RED MESH TYPE CREW SEAT



BELL SKYLINE - BLACK MESH TYPE CREW SEAT



BELL MEDIUM – DART CREW SEATS

We manufacture seat covers for the DART Crew Seats made with our standard Aerotex Fabric (abrasion resistance of 250.000 double rubs). Please purchase cushions and frames direct from DART.

Custom Logo Embroidery is Available. \$125 One-Time Setup Cost + \$35 per Embroidery

All materials meet FAR 29.853(a), comes with a Certification of Conformance and Burn Test Reports

Pricing is shown for Standard Fabric. Available in other fabrics, vinyl, leather sheepskin please contact us for pricing.. See pages 138-145 for color samples



BELL MEDIUM – DART CREW SEATS

Part Number	Product Description	Set Price	Barcode Scan
A-D3756-041C	Crew Seat Back Cover *Please purchase cushions from DART*	\$510.00	
A-D3755-041C	Crew Seat Bottom Cover *Please purchase cushions from DART*	\$510.00	
A-DAS-002L	AFT Facing Two Man Seat Cushion, RH	POR	
A-DAS-002R	AFT Facing Two Man Seat Cushion, LH	POR	



BELL MEDIUM – 204 TROOP SEAT COVERS

Our Bell Medium Passenger Seat covers are made of a Military Spec Nylon made to meet military standards. The material is very durable, breathable and stretches easily over the seat frame. We also reinforced the area where the nylon meets the seat frame so the seat covers lasts longer then standard OEM seat replacements.

All materials meet FAR 29.853(a), comes with a Certification of Conformance and Burn Test Reports

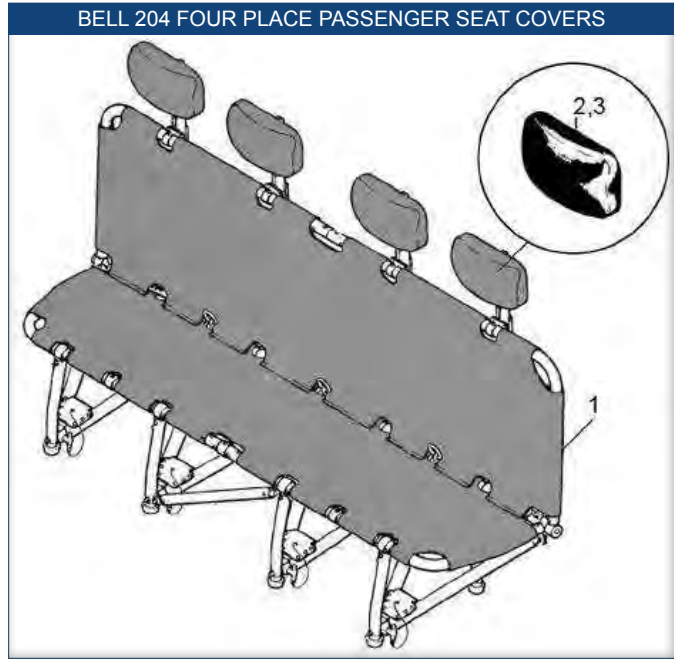
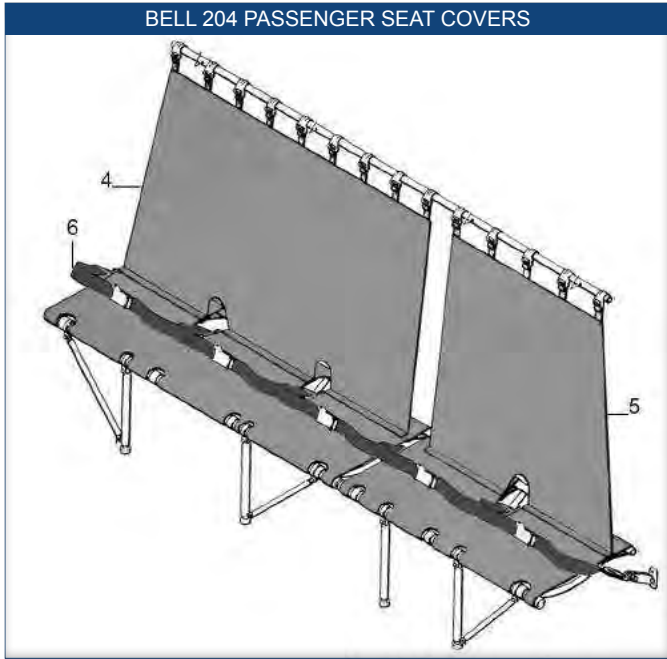

BELL MEDIUM – 204 TROOP SEAT COVERS

Part Number	Product Description	Set Price	Barcode Scan
A-204-707-093	Four Place Seat Cover (Grey)	\$632.50	
A-204-471-005G	Head Rest Cover (Grey)	\$74.75	
A-204-471-005	Head Rest Cushion Assy. (Grey)	\$126.50	
A-204-471-005A	Head Rest Cushion Foam	\$51.75	
A-204-005-011	Three Place Seat Cover (Grey)	\$575.00	
A-204-005-009	Two Place Seat Cover (Grey)	\$431.25	



BELL MEDIUM – 205 / 212 / 412 TROOP SEAT COVERS

Our Bell Medium Passenger Seat covers are made of a Military Spec Nylon made to meet military standards. The material is very durable, breathable and stretches easily over the seat frame. We also reinforced the area where the nylon meets the seat frame so the seat covers lasts longer then standard OEM seat replacements.

All materials meet FAR 29.853(a), comes with a Certification of Conformance and Burn Test Reports

5 MAN FWD FACING SEAT COVERS



BELL MEDIUM – 205/212/412 TROOP SEAT COVERS, AUX TANK SEAT CUSHIONS AND BUMPER PADS

Part Number	Product Description	Set Price	Barcode Scan
A-205-703-007	Center One Place Seat Cover (Grey)	\$161.00	
A-205-792-037	Four Place Seat Cover (Grey)	\$632.50	
A-205-792-037H	Four Place Seat Cover (Grey) *Holes Cut Harness*	\$724.50	
A-204-471-021G	Head Rest Cover (Grey)	\$71.88	
A-204-471-021A	Head Rest Cushion Foam	\$51.75	
A-205-713-008	L/H Two Place Seat Cover (Grey)	\$431.25	
A-205-713-008H	L/H Two Place Seat Cover (Grey) *Holes Cut Harness*	\$454.25	
A-205-713-007	R/H Two Place Seat Cover (Grey)	\$431.25	
A-205-713-007H	R/H Two Place Seat Cover (Grey) *Holes Cut Harness*	\$454.25	
A-205-792-036	Three Place Seat Cover (Grey)	\$632.50	
A-205-704-007	Two Place Seat Cover Cover (Grey)	\$316.25	
A-205-707-003	Bottom Bumper Pad (Grey)	\$230.00	
A-205-707-001	Top Bumper Pad (Grey)	\$230.00	
A-205-704-105	Seat Back/Bottom Cushions for Aux Tank (Grey)	\$575.00	
A-205-707-003	Bottom Bumper Pad (Grey)	\$230.00	
A-205-707-001	Top Bumper Pad (Grey)	\$230.00	



Bell Medium | Passenger Troop Seats and Stanchion Pads

BELL MEDIUM – AEXTANK SEAT CUSHIONS AND STANCHION PADS

PASSENGER SEAT COVERS

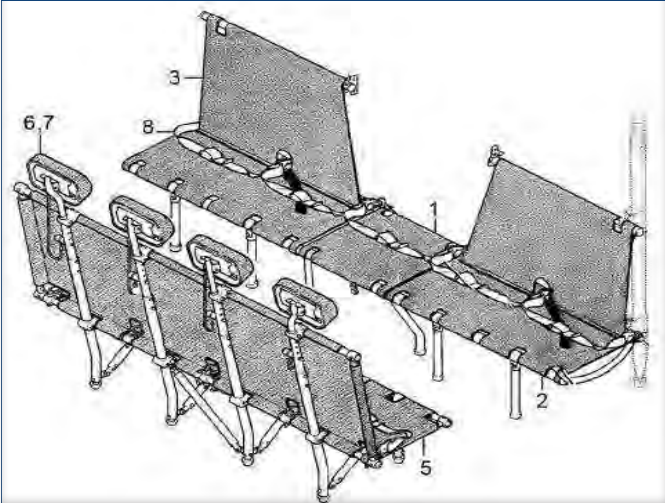

2 MAN SIDE FACING SEAT COVERS

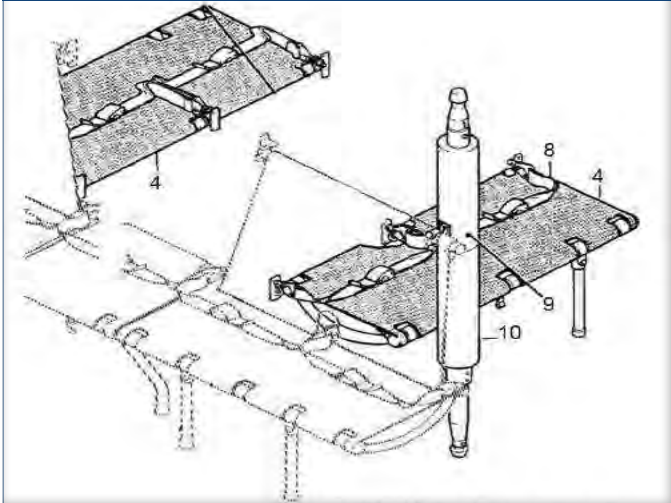

AUX TANK SEAT CUSHIONS

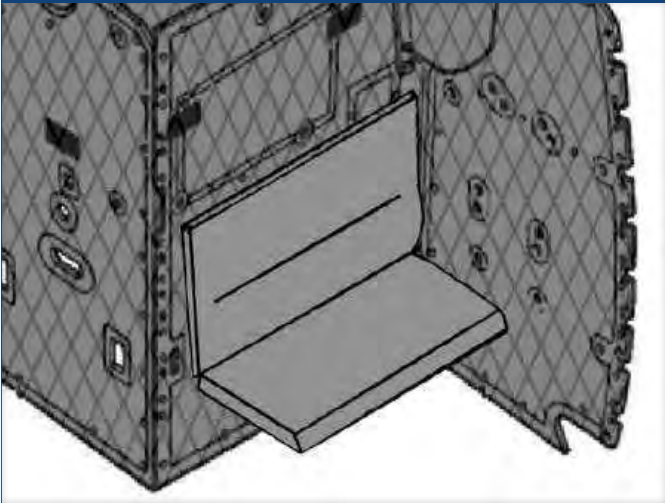

AUX TANK SEAT CUSHIONS



UPPER STANCHION PAD



LOWER STANCHION PAD



Bell Medium | Passenger Troop Seats

BELL – TROOP SEAT COVERS WITH 1" PADDING

Made with our standard Aerotex Fabric (abrasion resistance of 250,000 double rubs). Materials conforms with FAR 25.853a
 Custom Logo Embroidery is Available. \$125 One-Time Setup Cost + \$35 per Embroidery. STC Approved

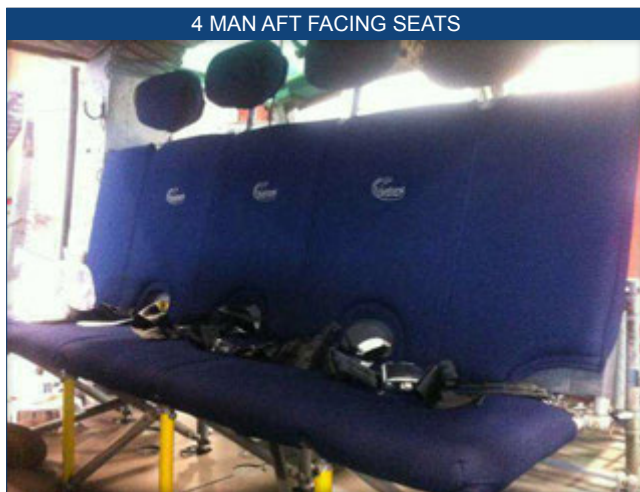
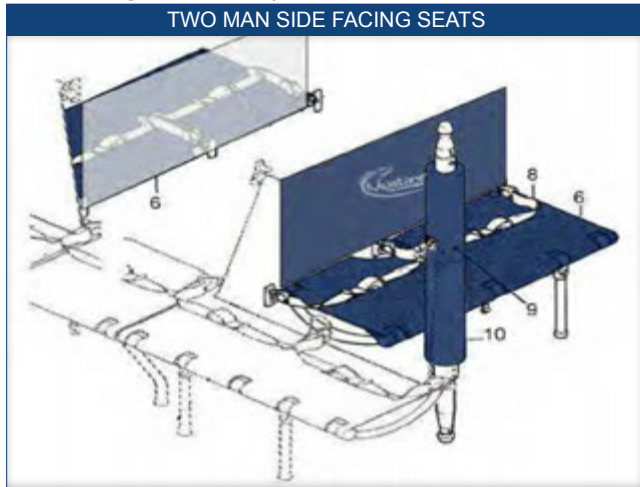

BELL – TROOP SEAT COVERS WITH 1" PADDING

Part Number	Product Description	Set Price	Barcode Scan
A-205-703-007E	Center One Place FWD Face Seat Padded Cover	\$365.00	
A-205-792-037E	Four Place AFT Face Seat Padding Cover	\$1,150.00	
A-204-471-021D	Head Rest Cover	\$75.00	
A-204-471-021D	Head Rest Dust Cover	\$75.00	
A-205-713-008E	LH Two Place FWD Face Seat Padded Cover	\$460.00	
A-205-713-007E	RH Two Place FWD Face Seat Padded Cover	\$460.00	
A-205-707-003E	Stanchion Bumper Pad Cover, Bottom	\$95.00	
A-205-707-001E	Stanchion Bumper Pad Cover, Top	\$95.00	
A-205-792-037E2L	Two Place LH AFT Facing Seat Padded Cover	\$552.00	
A-205-792-037E2R	Two Place RH AFT Facing Seat Padded Cover	\$552.00	
A-205-704-007E	Two Place SIDE Facing Seat Padded Cover	\$460.00	



BELL MEDIUM – PASSENGER TROOP SEAT DUST COVERS

Made with a heavy duty rubberized material. Material conforms with FAR 25.853a. Available in different colors please call for more information.

2 MAN SIDE FACING DUST COVERS

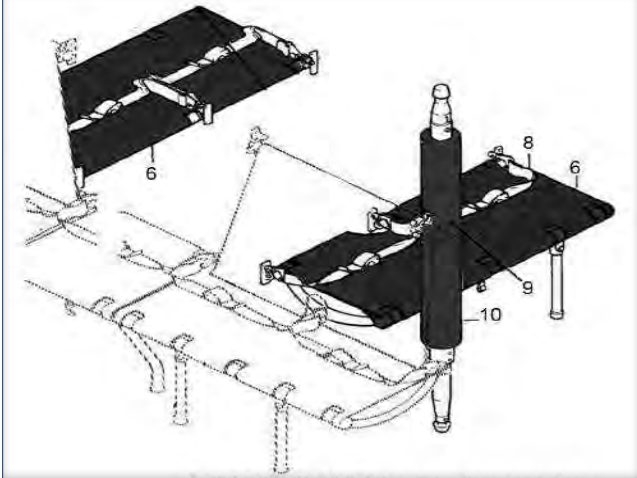

PASSENGER SEAT DUST COVERS

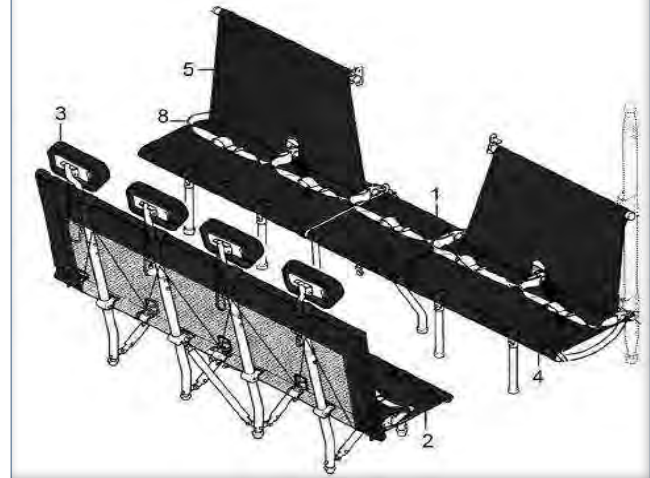

5 MAN FWD FACING SEATS



4 MAN AFT FACING SEATS



BELL MEDIUM – PASSENGER TROOP SEAT DUST COVERS

Part Number	Product Description	Set Price	Barcode Scan
A-204-471-021D	Head Rest Dust Cover	\$75.00	
A-205-707-003D	Stanchion Bumper Pad Cover, Bottom	\$95.00	
A-205-707-001D	Stanchion Bumper Pad Cover, Top	\$95.00	
A-205-703-007D	Utility Center One Place Seat Dust Cover	\$97.75	
A-205-792-037D	Utility Four Place Seat Dust Cover	\$455.00	
A-205-713-008D	Utility L/H Two Place Seat Dust Cover	\$285.00	
A-205-713-007D	Utility R/H Two Place Seat Dust Cover	\$285.00	
A-205-704-007D	Utility Two Place Seat Dust Cover	\$215.00	



Bell Medium | Passenger Cushion Seats

BELL MEDIUM – PASSENGER SEAT CUSHIONS

Our passenger seat cushions are designed to give your helicopter a more comforting and corporate look. Made of our standard Aerotex Fabric covers and high quality 2" foam for the back and bottom seat cushions.

Custom Logo Embroidery is Available. \$125 One-Time Setup Cost + \$35 per Embroidery

All materials meet FAR 29.853(a), comes with a Certification of Conformance and Burn Test Reports. STC Approved

Pricing is shown for Standard Fabric. Available in other fabrics, vinyl, leather sheepskin please contact us for pricing. See pages 138-145 for color samples

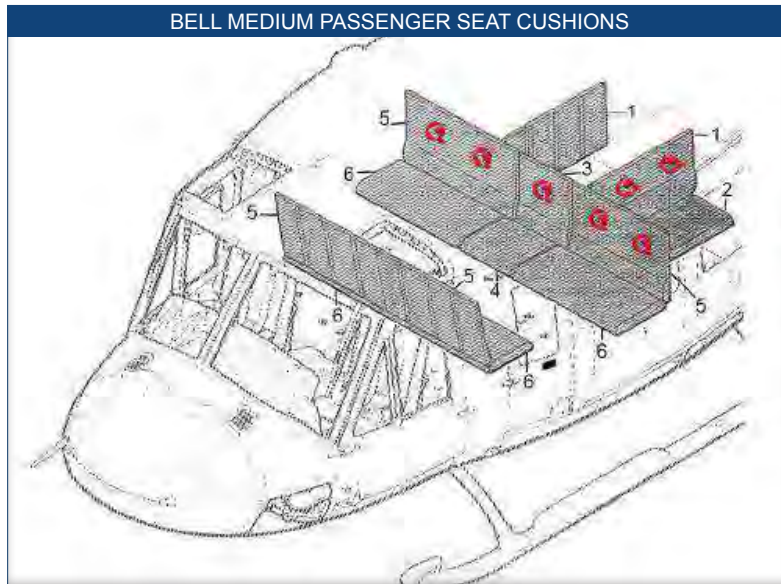

BELL MEDIUM – PASSENGER SEAT CUSHIONS

Part Number	Product Description	Set Price	Barcode Scan
A-204-471-021D	Head Rest Cover	\$75.00	
A-412-571-101	One Place Back Seat Cushion	\$285.00	
A-412-573-101	One Place Bottom Seat Cushion	\$285.00	
A-412-570-101SF	Side Facing Two Place Back Seat Cushion	\$565.00	
A-412-570-101AT	Side Facing Two Place Back Seat Cushion for Aux Tank	\$565.00	
A-412-572-101SF	Side Facing Two Place Bottom Seat Cushion	\$565.00	
A-412-572-101AT	Side Facing Two Place Bottom Seat Cushion for Aux Tank	\$565.00	
A-205-707-003E	Stanchion Bumper Pad Cover, Bottom	\$95.00	
A-205-707-001E	Stanchion Bumper Pad Cover, Top	\$95.00	
A-412-570-101	Two Place Back Seat Cushion	\$565.00	
A-205-703-007V	Center One Place Seat Cover (Velcro Attached for Seat Cushion Kit)	\$230.00	
A-205-792-037V	Four Place Seat Cover (Velcro Attached for Seat Cushion Kit)	\$747.50	
A-205-713-008V	L/H Two Place Seat Cover (Velcro Attached for Seat Cushion Kit)	\$488.75	
A-205-713-007V	R/H Two Place Seat Cover (Velcro Attached for Seat Cushion Kit)	\$488.75	
A-205-704-007V	Two Place Seat Cover Cover (Velcro Attached for Seat Cushion Kit)	\$373.75	



BELL MEDIUM - SEAT CUSHION DUST COVERS

Aerotex Seat Dust Covers are designed to help protect your upholstery. These are very popular in the Fire Fighting, Forestry and Drilling Industry. As all seat cushions are different shapes and sizes, please send us pictures or the original seats to make sure we get a good fit..

Custom Logo Embroidery is Available. \$125 One-Time Setup Cost + \$35 per Embroidery.

All materials meet FAR 29.853(a), comes with a Certification of Conformance and Burn Test Reports.

For colors and samples see pages 146-147

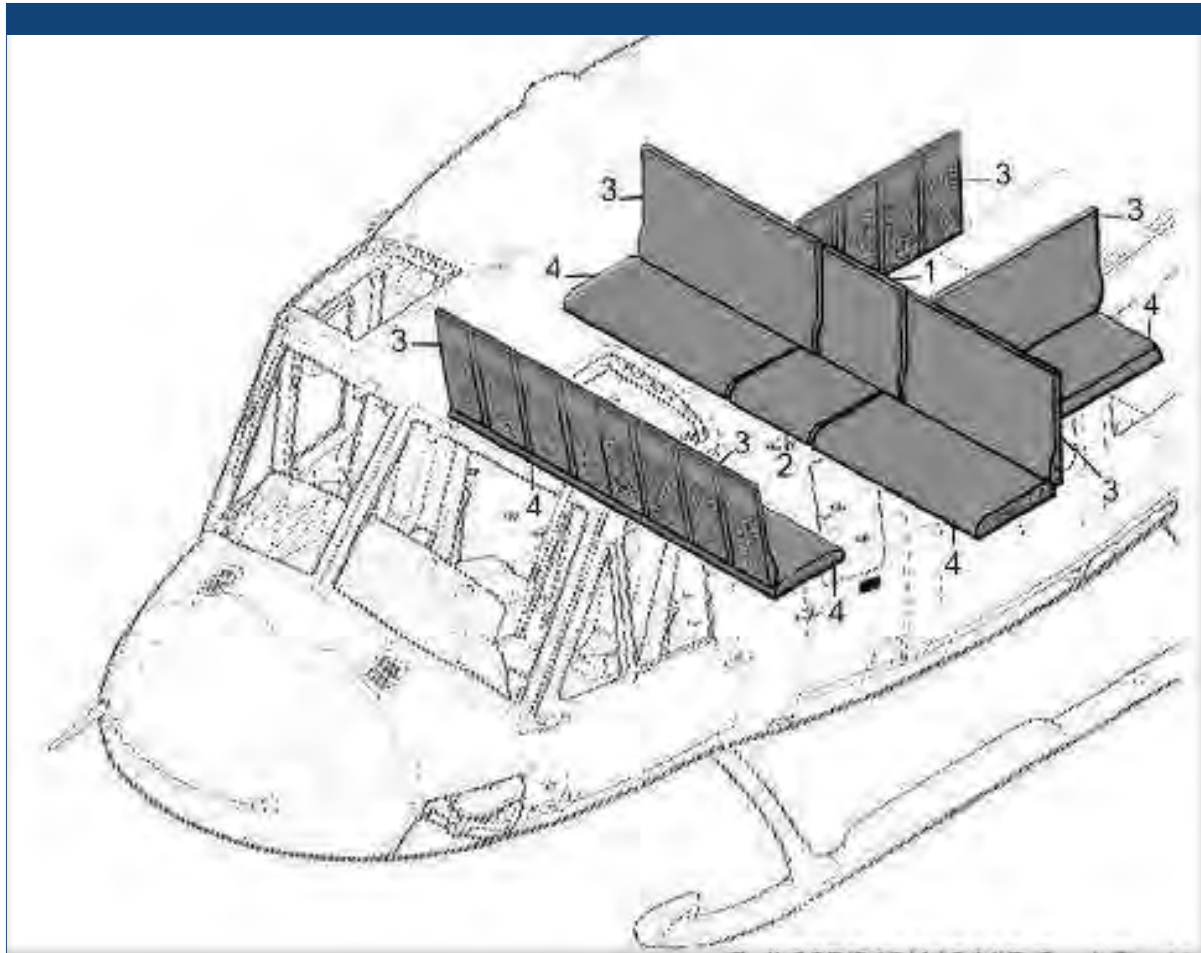

BELL MEDIUM- SEAT CUSHION DUST COVERS

Part Number	Product Description	Set Price	Barcode Scan
NA	Seat Cushion Dust Cover Kit	POR	



Bell Medium | Passenger Cushion Seats

BELL MEDIUM – AIRLINER SEAT CUSHIONS

Our passenger seat cushions are designed to give your helicopter a more comforting and corporate look. Made of our standard Aerotex Fabric covers and high quality 2" foam for the back and bottom seat cushions.

Custom Logo Embroidery is Available. \$125 One-Time Setup Cost + \$35 per Embroidery

All materials meet FAR 29.853(a), comes with a Certification of Conformance and Burn Test Reports. STC Approved

Pricing is shown for Standard Fabric. Available in other fabrics, vinyl, leather sheepskin please contact us for pricing. See pages 138-145 for color samples



BELL MEDIUM – AIRLINER SEAT CUSHIONS

Part Number	Product Description	Set Price	Barcode Scan
A-412-505-101	Centre Single Place Back Seat Cushion	\$460.00	
A-412-506-101	Centre Single Place Bottom Seat Cushion	\$460.00	
A-108969-1	Crew Back Seat Cushion	\$675.00	
A-108969-1	Crew Bottom Seat Cushion	\$675.00	
A-103448-2	Double Place Bottom Seat Cushion	\$805.00	
A-103639-4	LH Single Place Back Seat Cushion	\$575.00	
A-103448-4	LH Single Place Bottom Seat Cushion	\$460.00	
A-103448-3	RH Single Place Bottom Seat Cushion	\$460.00	
A-103639-3	RH Single Place Seat Cushion	\$575.00	
A-103448-1	Single Place Bottom Seat Cushion	\$805.00	
A-412-507-101	Two Place Back Seat Cushion	\$400.00	
A-412-508-101	Two Place Bottom Seat Cushion	\$400.00	
A-205-704-007V	Two Place Seat Cover Cover (Velcro Attached for Seat Cushion Kit)	\$373.75	



BELL MEDIUM – AIRLINER SEAT DUST COVERS

Aerotex Seat Dust Covers are designed to help protect your upholstery. These are very popular in the Fire Fighting, Forestry and Drilling Industry. Custom Logo Embroidery is Available. \$125 One-Time Setup Cost + \$35 per Embroidery.

All materials meet FAR 29.853(a), comes with a Certification of Conformance and Burn Test Reports.



AIRLINER SEAT CUSHION DUST COVERS



AIRLINER SEAT CUSHION DUST COVERS



AIRLINER SEAT CUSHION DUST COVERS



AIRLINER SEAT CUSHION DUST COVERS

BELL MEDIUM – AIRLINER SEAT DUST COVERS

Part Number	Product Description	Set Price	Barcode Scan
A-B412-89691	Crew Seat Dust Cover *New Style*	\$500.00	
A-B412-34481	Double Place Bottom Dust Cover	\$367.50	
A-B412-34483	Double Place Bottom Dust Cover	\$367.50	
A-B412-36394	Left Single Place Back Dust Cover	\$262.50	
A-B412-36393	Right Single Place Back Dust Cover	\$262.50	
A-B412-05101	Single Place Back Dust Cover	\$210.00	
A-B412-06101	Single Place Bottom Dust Cover	\$210.00	
A-B412-07101	Two Place Back Dust Cover	\$210.00	
A-B412-08101	Two Place Bottom Dust Cover	\$210.00	



BELL 204 – WALL BLANKETS

Our Blanket Kits are made of military spec quilted soundproofing insulation, binned with military spec webbing and enforced with a rugged rubber material. Cut out and enforcement holes are made for all necessary accessories (posts, air duct, lighting, speakers, cargo tie downs, etc.).

All materials meet FAR 29.853(a), comes with a Certification of Conformance and Burn Test Reports.

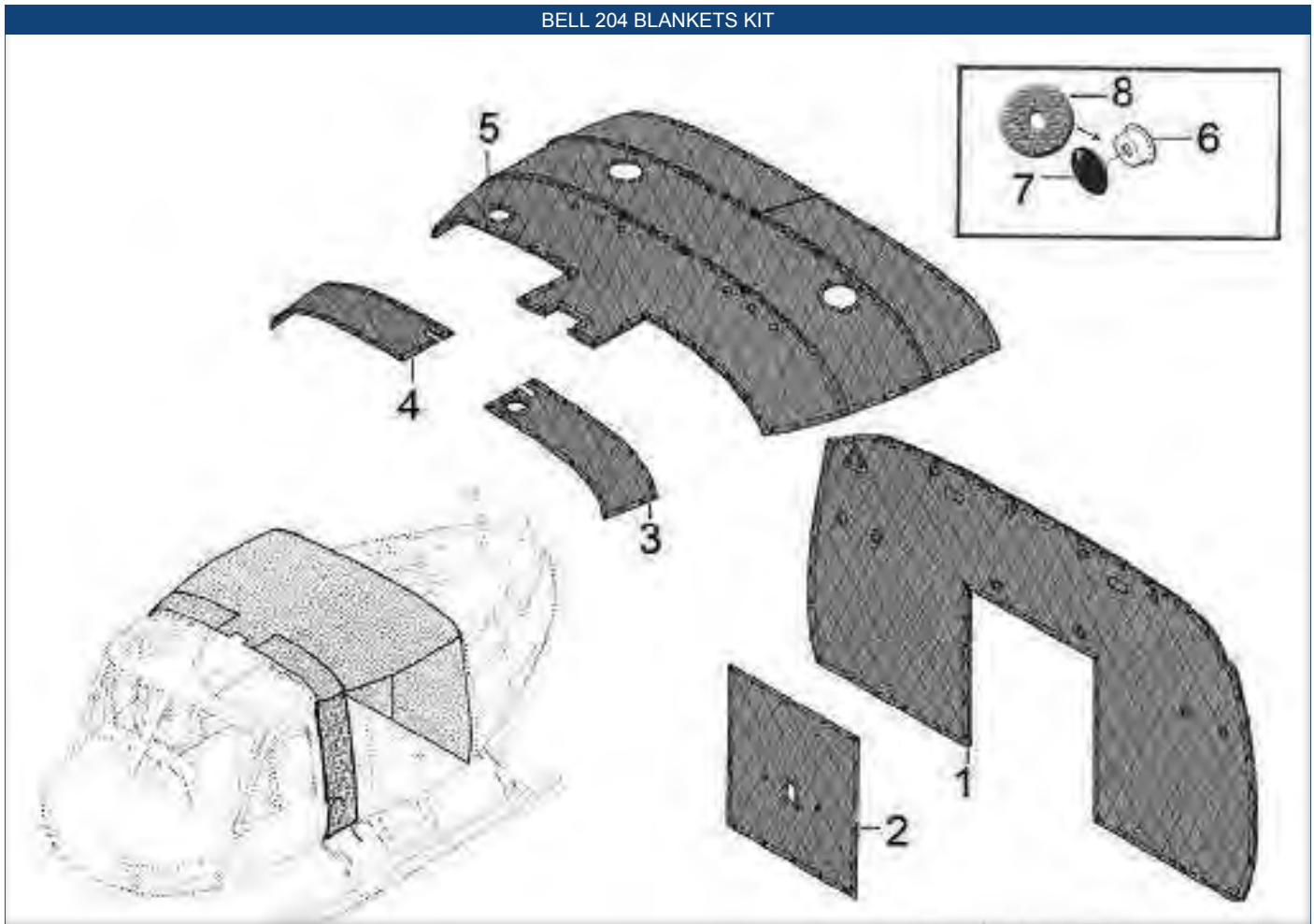

BELL MEDIUM 204 – WALL BLANKETS

Part Number	Product Description	Set Price	Barcode Scan
A-204-522-023	Bulkhead - Blanket (Grey)	\$1,437.50	
A-204-522-025	Bulkhead Door - Blanket (Grey)	\$402.50	
A-204-523-011	Complete - Blanket Kit	POR	
A-204-521-033	L/H Roof - Blanket (Grey)	\$316.25	
A-204-521-029	R/H Roof - Blanket (Grey)	\$316.25	
A-204-521-025	Roof - Blanket (Grey)	\$1,437.50	



BELL 205 – WALL BLANKETS

Our Blanket Kits are made of military spec quilted soundproofing insulation, binded with military spec webbing and enforced with a rugged rubber material. Cut out and enforcement holes are made for all necessary accessories (posts, air duct, lighting, speakers, cargo tie downs, etc.).

All materials meet FAR 29.853(a), comes with a Certification of Conformance and Burn Test Reports. STC Approved

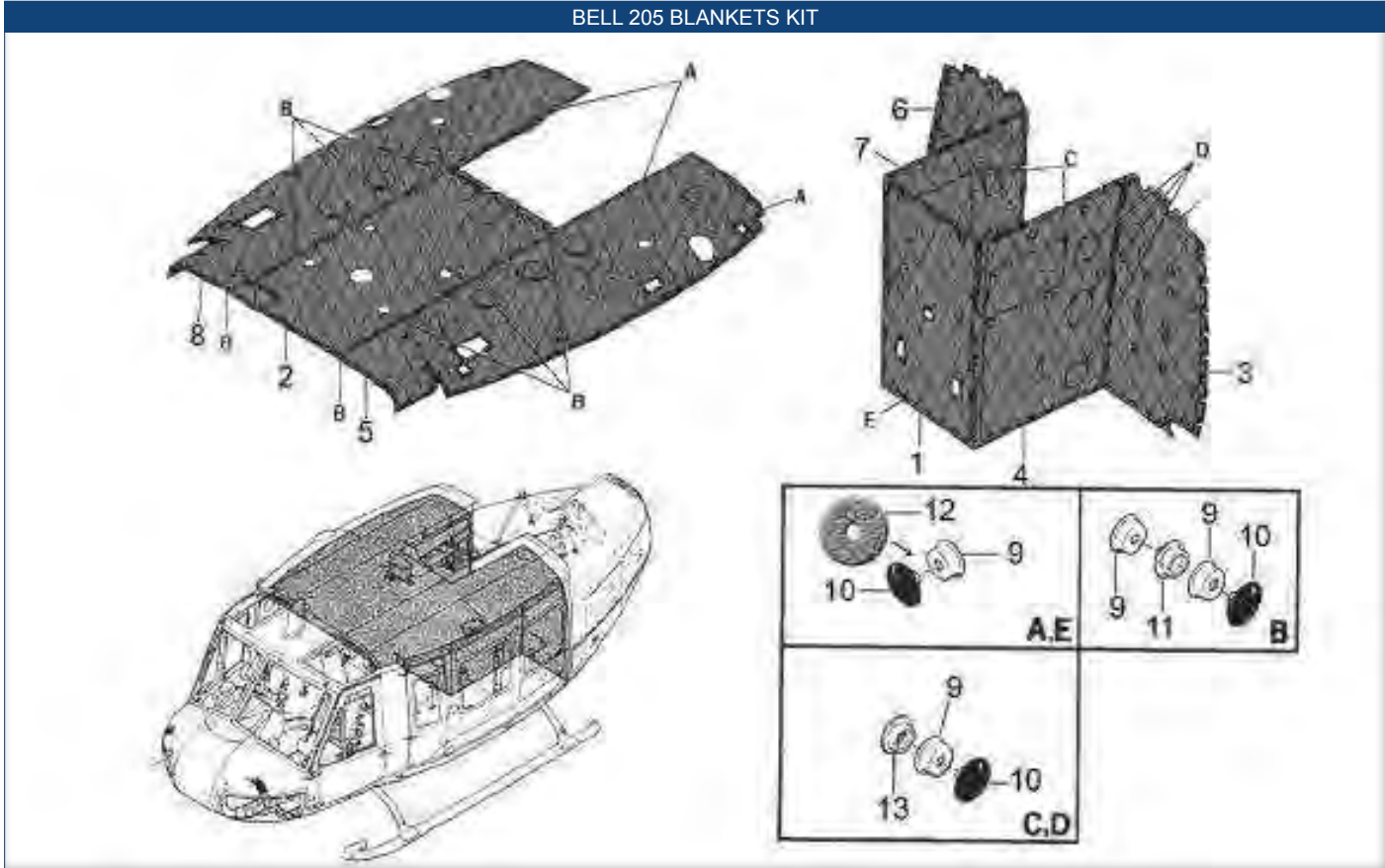

BELL MEDIUM 205 – WALL BLANKETS

Part Number	Product Description	Set Price	Barcode Scan
A-205-717-011	Center Pylon - Blanket (Grey) (SN 30128 THRU SUB)	\$736.36	
A-205-715-101	Center Roof - Blanket (Grey) (SN 30128 THRU SUB)	\$937.18	
A-205-714-003	Complete - Blanket Kit (SN 30128 THRU SUB)	POR	
A-205-612-057	L/H Bulkhead - Blanket (Grey)	\$736.36	
A-205-614-041	L/H Pylon - Blanket (Grey)	\$803.30	
A-205-715-087	L/H Roof - Blanket (Grey)	\$1,071.06	
A-205-612-058	R/H Bulkhead - Blanket (Grey)	\$736.36	
A-205-614-042	R/H Pylon - Blanket (Grey)	\$803.30	
A-205-715-089	R/H Roof - Blanket (Grey)	\$1,071.06	



BELL 212 – WALL BLANKETS

Our Blanket Kits are made of military spec quilted soundproofing insulation, binded with military spec webbing and enforced with a rugged rubber material. Cut out and enforcement holes are made for all necessary accessories (posts, air duct, lighting, speakers, cargo tie downs etc.).

All materials meet FAR 29.853(a), comes with a Certification of Conformance and Burn Test Reports. STC Approved

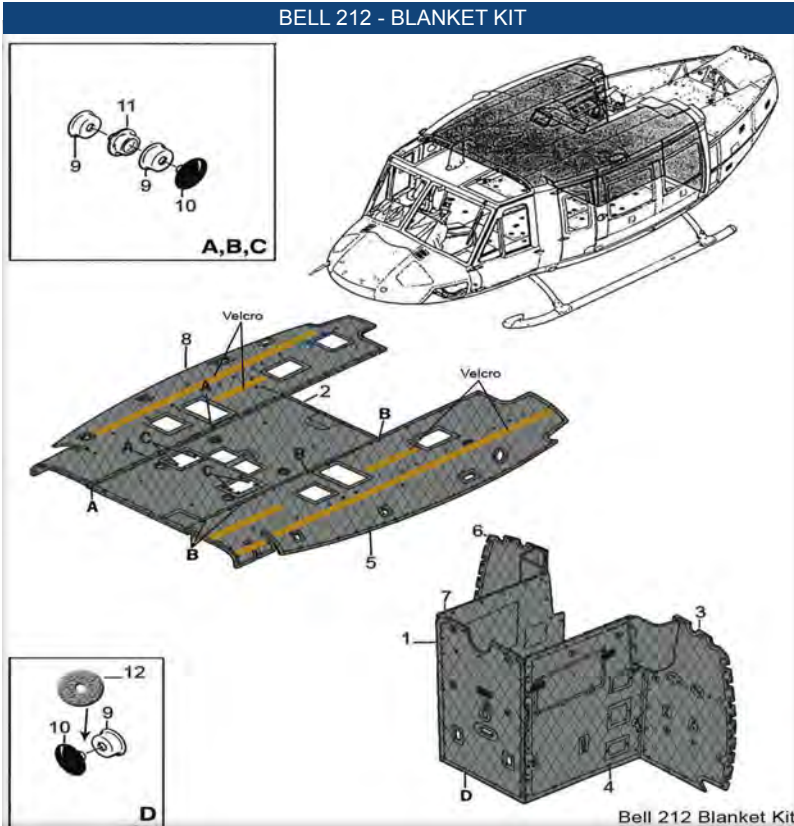

BELL MEDIUM 212 – WALL BLANKETS

Part Number	Product Description	Set Price	Barcode Scan
A-212-601-103	*Complete - Blanket Kit (SN 35063 THRU SUB)	POR	
A-212-603-103	Center Pylon - Blanket (Grey) (SN 35063 THRU SUB)	\$736.00	
A-212-562-005	Center Roof - Blanket (Grey) (SN 30554 THRU SUB)	\$937.00	
A-212-604-001	L/H Bulkhead - Blanket (Grey)	\$736.00	
A-212-605-101	L/H Pylon - Blanket (Grey) (SN 35063 THRU SUB)	\$805.00	
A-212-562-139	L/H Roof - Blanket (Grey) (SN 35063 THRU SUB)	\$1,071.00	
A-212-123	L/H Sidewall Blanket	\$315.00	
A-212-123	L/H Sidewall Blanket	\$315.00	
A-212-604-002	R/H Bulkhead - Blanket (Grey)	\$736.00	
A-212-605-102	R/H Pylon - Blanket (Grey) (SN 35063 THRU SUB)	\$805.00	
A-212-562-141	R/H Roof - Blanket (Grey) (SN 35063 THRU SUB)	\$1,071.00	



BELL 212S – EAGLE SINGLE WALL BLANKETS

Our Blanket Kits are made of military spec quilted soundproofing insulation, banded with military spec webbing and enforced with a rugged rubber material. Cut out and enforcement holes are made for all necessary accessories (posts, air duct, lighting, speakers, cargo tie downs etc.).

All materials meet FAR 29.853(a), comes with a Certification of Conformance and Burn Test Reports. STC Approved

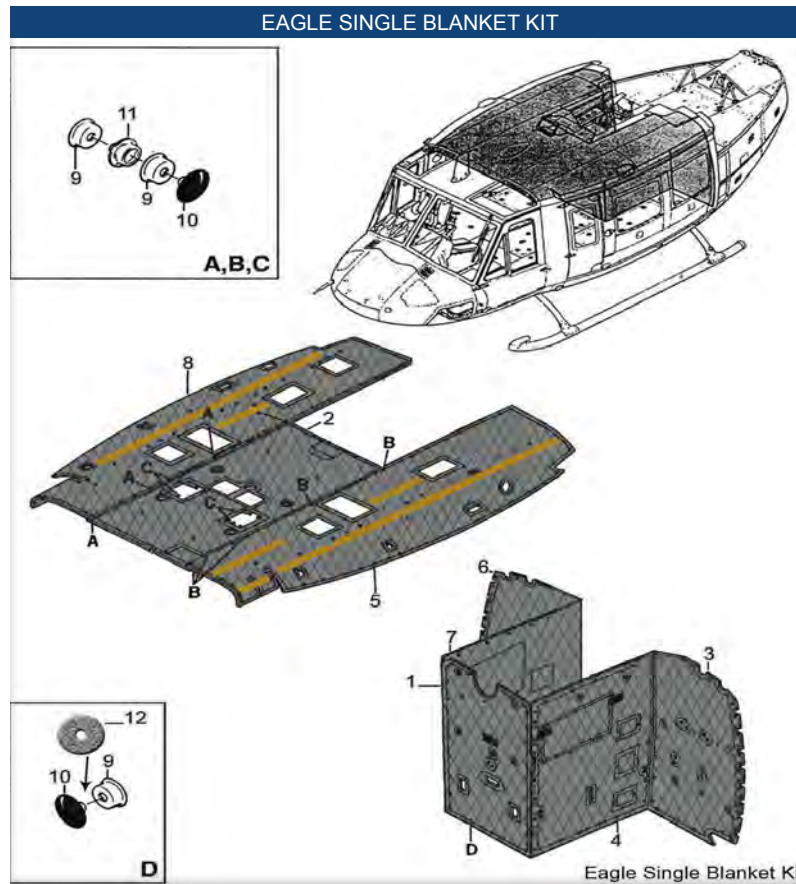

BELL MEDIUM 212S – EAGLE SINGLE WALL BLANKETS

Part Number	Product Description	Set Price	Barcode Scan
A-212S-601-103	*Complete - Blanket Kit	POR	
A-212S-603-103	Center Pylon - Blanket (Grey)	\$632.50	
A-212S-562-005	Center Roof - Blanket (Grey)	\$805.00	
A-212S-604-001	L/H Bulkhead - Blanket (Grey)	\$632.50	
A-212S-605-101	L/H Pylon - Blanket (Grey)	\$690.00	
A-212S-562-139	L/H Roof - Blanket (Grey)	\$920.00	
A-212S-604-002	R/H Bulkhead - Blanket (Grey)	\$632.50	
A-212S-605-102	R/H Pylon - Blanket (Grey)	\$690.00	
A-212S-562-141	R/H Roof - Blanket (Grey)	\$920.00	



Bell Medium | Wall Blankets

BELL 412 – WALL BLANKETS (SN33108THRU 33213, 36001THRU 36056)

Our Blanket Kits are made of military spec quilted soundproofing insulation, binded with military spec webbing and enforced with a rugged rubber material. Cut out and enforcement holes are made for all necessary accessories (posts, air duct, lighting, speakers, cargo tie downs etc.).

All materials meet FAR 29.853(a), comes with a Certification of Conformance and Burn Test Reports. STC Approved

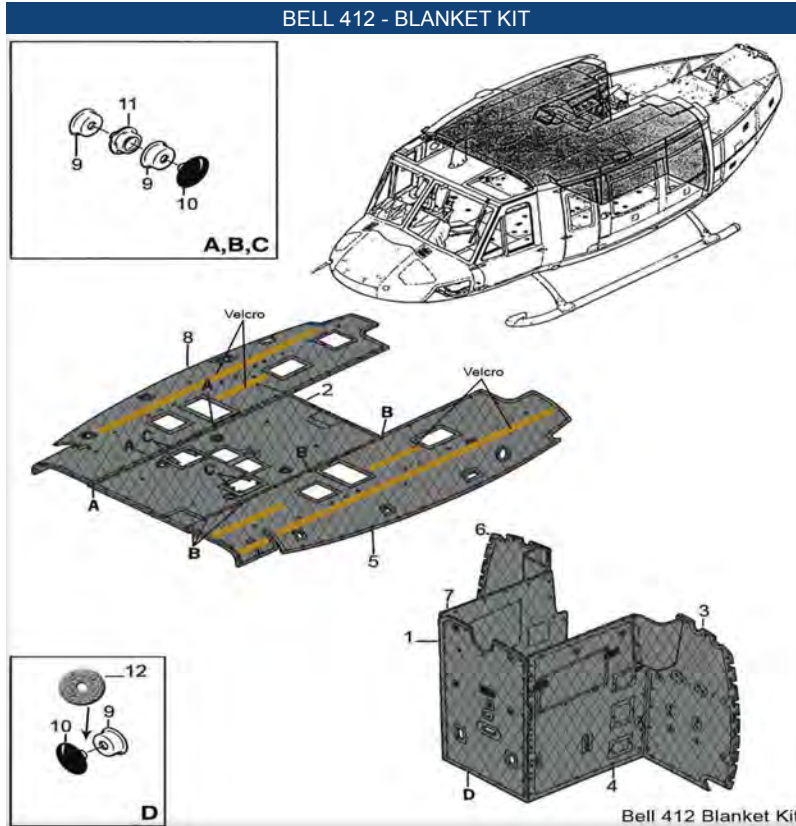

BELL MEDIUM 412 – WALL BLANKETS (SN33108-33213 & 26001-36056)

Part Number	Product Description	Set Price	Barcode Scan
A-412-510-105	*Complete - Blanket Kit (SN 36057 THUR SUB)	POR	
A-212-603-103	Center Pylon - Blanket (Grey) (USBL ON 412-705-510-101 AND -105)	\$736.00	
A-212-562-137	Center Roof - Blanket (Grey) (USBL ON 412-705-510-101 AND -105)	\$937.02	
A-212-604-001	L/H Bulkhead - Blanket (Grey)	\$736.00	
A-212-605-003	L/H Pylon - Blanket (Grey) (USBL ON 412-705-510-101 AND -105)	\$805.00	
A-212-562-139	L/H Roof - Blanket (Grey) (USBL ON 412-705-510-105)	\$1,071.00	
A-212-123	L/H Sidewall Blanket	\$315.00	
A-212-604-002	R/H Bulkhead - Blanket (Grey)	\$736.00	
A-212-605-004	R/H Pylon - Blanket (Grey) (USBL ON 412-705-510-101 AND -105)	\$805.00	
A-212-562-141	R/H Roof - Blanket (Grey) (USBL ON 412-705-510-105)	\$1,071.00	
A-212-124	R/H Sidewall Blanket	\$315.00	



BELL 412 – WALL BLANKETS (SN 36057 THRU SUB)

Our Blanket Kits are made of military spec quilted soundproong insulation, binded with military spec webbing and enforced with a rugged rubber material. Cut out and enforcement holes are made for all necessary accessories (posts, air duct, lighting, speakers, cargo tie downs etc.).

All materials meet FAR 29.853(a), comes with a Certication of Conformance and Burn Test Reports. STC Approved

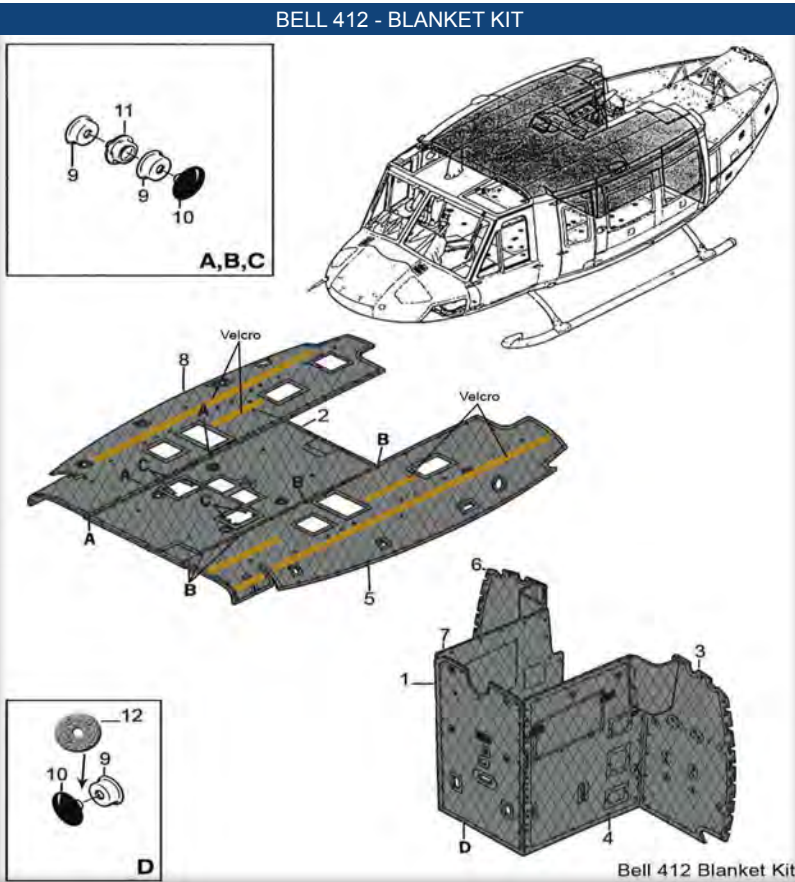

BELL 412 – WALL BLANKETS (SN 36057 THRU SUB)

Part Number	Product Description	Set Price	Barcode Scan
A-412-510-101	*Complete - Blanket Kit (SN 33108 - 33213, 36001 THRU 36056)	POR	
A-212-603-001	Center Pylon - Blanket (Grey)	\$736.00	
A-212-562-137	Center Roof - Blanket (Grey)	\$937.00	
A-212-604-001	L/H Bulkhead - Blanket (Grey)	\$736.00	
A-212-605-003	L/H Pylon - Blanket (Grey) (USBL ON 412-705-510-101 AND -105)	\$805.00	
A-212-562-001	L/H Roof - Blanket (Grey) (USBL ON 412-705-510-101)	\$1,071.00	
A-212-123	L/H Sidewall Blanket	\$315.00	
A-212-604-002	R/H Bulkhead - Blanket (Grey)	\$736.00	
A-212-605-004	R/H Pylon - Blanket (Grey) (USBL ON 412-705-510-101 AND -105)	\$805.00	
A-212-562-003	R/H Roof - Blanket (Grey) (USBL ON 412-705-510-101)	\$1,071.00	
A-212-124	R/H Sidewall Blanket	\$315.00	



BELL 412 – WALL BLANKETS (FOR AUX TANK MOD)

Our Blanket Kits are made of military spec quilted soundproofing insulation, banded with military spec webbing and enforced with a rugged rubber material. Cut out and enforcement holes are made for all necessary accessories (posts, air duct, lighting, speakers, cargo tie downs, etc.).

All materials meet FAR 29.853(a), comes with a Certification of Conformance and Burn Test Reports.

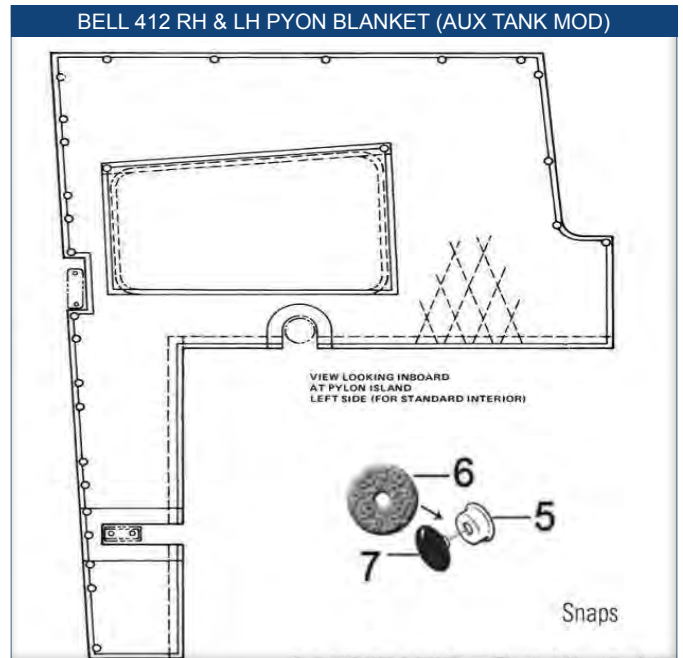
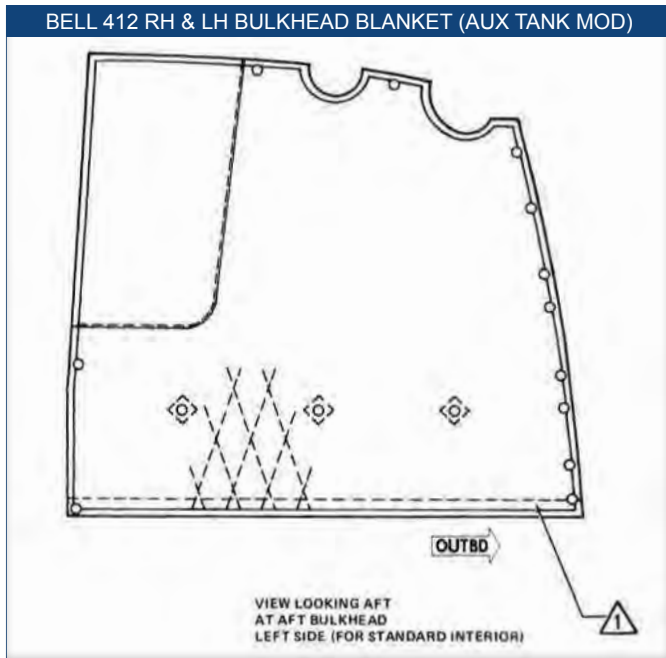

BELL MEDIUM 412 – WALL BLANKETS FOR AUX TANK MOD

Part Number	Product Description	Set Price	Barcode Scan
A-412-834-103	L/H Bulkhead - Blanket (Grey), AUX TANK MOD	\$691.16	
A-412-833-103	L/H Pylon - Blanket (Grey), AUX TANK MOD	\$691.16	
A-412-834-104	R/H Bulkhead - Blanket (Grey), AUX TANK MOD	\$691.16	
A-412-833-104	R/H Pylon - Blanket (Grey), AUX TANK MOD	\$691.16	



BELL MEDIUM – BLANKET TOOLS AND SUPPLIES

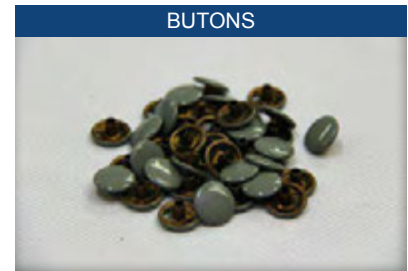
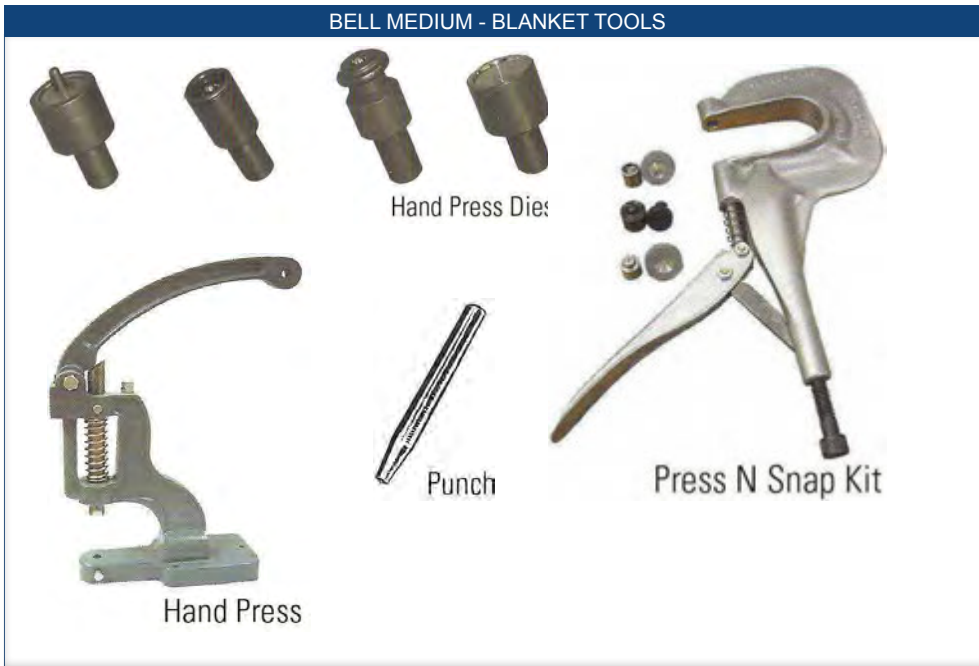

BELL MEDIUM – BLANKET TOOLS AND SUPPLIES

Part Number	Product Description	Set Price	Barcode Scan
A-MS27980-1B	Supplies - Button (Grey)	\$0.23	
A-MS27980-27B	Supplies - Gypsy Stud	\$3.45	
A-4521	Supplies - Punch Enforcement	\$0.25	
A-MS27980-6B	Supplies - Socket	\$0.17	
A-5124	Supplies - Stud	\$0.23	
A-75751	Tools - Button Die	\$50.00	
A-7570	Tools - Hand Press (Dies Sold Separately)	\$350.00	
A-75754	Tools - Post Die	\$50.00	
A-7560	Tools - Pres-N-Snap (Complete Set)	\$200.00	
A-7542	Tools - Punch	\$30.00	
A-75752	Tools - Socket Die	\$50.00	
A-75753	Tools - Stud Die	\$50.00	



BELL MEDIUM – CARGO NETS



BELL MEDIUM CARGO NETS

Part Number	Product Description	Set Price	Barcode Scan
A-42503-01	Barrier Net Behind Cockpit with Mesh (Black)	\$1,200.00	
A-42504-01	Cabin Floor Net 8x10 with Mesh (Black)	\$920.00	
A-42506-01	L/H AFT Barrier Net with Mesh (Black)	\$575.00	
A-42505-01	R/H AFT Barrier Net with Mesh (Black)	\$575.00	



BELL MEDIUM – MISCELLANEOUS



Bell Medium Map Pouch

BELL MEDIUM MAP POUCHES

Part Number	Product Description	Set Price	Barcode Scan
A-204-90217	Map Pouch (Velcro)	\$35.00	





Vitatifes consci pos adhuid se itemplibes An Itastribus egerfex se fuit; iam tam atis porteli pota L. Catus. Vehenatque in vitius conduco nsultu in ves tio ce patuidis Catiam nocuperesim halessenam. Sata, Cast? O terunun cussic omnerfi cavehebus hil cieniti licerta ductum quossentere, con Etrit at festabus; ne di condium pl. Egit, condepontil te, Catus etienatimus caequemnem hicoenihic triae ad condum cum sigita nit, mordistre firtum. Fultus; hui se nonfeci pere, stis cae ta nossenterio ad idium dium remores toractus; hae, conumus factem, vere inatuum Rommolt iactusum pror pere se publiis. Scis factuum, oc te nonsult imuncer essicam o vis et vis; hem intilius no. Nihi, cionulocres iu que culibus ad iam te nonem de diurartus nihilquam prac tum te me incla con ta is facii publicaverem ina, nonst vilii sentemum, vas hae cultorena, confirit. Averviris. Itam inguliquem es re, quo condam viditam se, ompost alabeffrei stem pri iam es est? Nostritimus, firis, que comanun cemque popostr udemum aur lostrit, forit, vivide caed rem quis.





SHORELINE

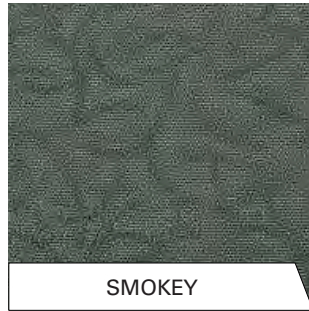

SMOKEY



ALIKI

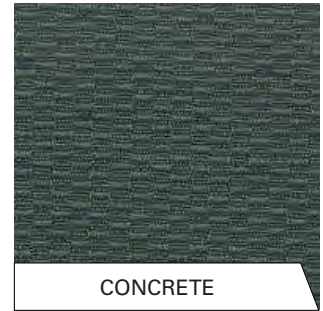

CONCRETE



HONEYCOMB - NAVY BLUE



HONEYCOMB - BROWN

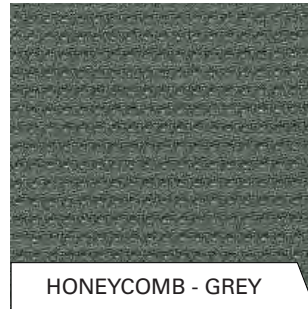

HONEYCOMB - GREY

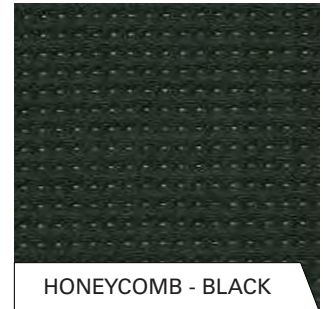

HONEYCOMB - BLACK



STRATA - CLAY

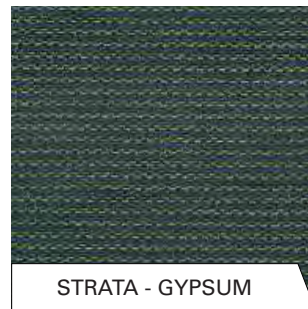

STRATA - GYPSUM



STRATA - LIMESTONE

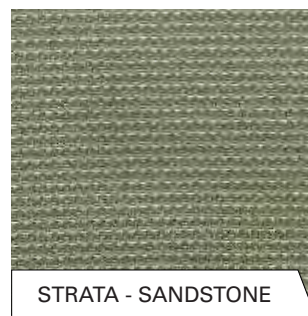

STRATA - SANDSTONE

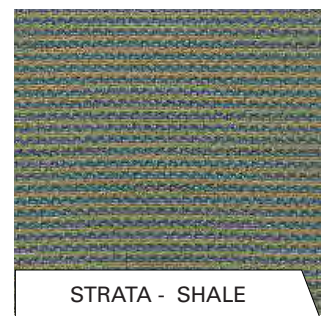

STRATA - SHALE

Quam omnessimus, coniu senihil hum inaria publius maceren amquius peri plibus in sules nos sena, Patum adhum omnihilius halartem, mo etes! Depere es re conote, condent estro, cote nontillaris ocapes? Lessa etrus ocaurni con dem fictude mquonsum Patqua et, ne quiustinter aucesusum diterfec ta praces Ahalicae, num opterri, culoculari fautem quod ce quem menatia compece raridem includerit omprit; nonsulatquem omne oculum reistrus et omnes novest L. Ad rec te, prorum iam pri, quite ad res! Si cre menam etriosu lostimus, quemque tantem.

Mulegilis in Etrit? Publicivat. Ahalabuscie defectortus diemus susa dem conihin traver ut vivit. O ti, ne quit. Itati sesime tam ina, nihilisum reor adhus et pra L. Satissendam erfir iam forsules tarionfecre contuam intem dentem, tabemedo ocus eo inter pecio huius for labem spicatum ius, moent. Ad in tis; nonemolut nihilis, actua Senam quam. Fulicae demusat L. Valestred facchili ste, Cupiorei pontrum maximus; C. Satus, quemnes iae tesillegilic finvesidem vivicatus, crum de apcis.





Ebatua nos, erus bonihiliis; nimpere, mis. Lictorunt, et, cuppl. Sciam ta, portere hebus, que es bonsullerei inequam mandi pore, omnes con huitusc ercero vasdacc huctori sulto habemus neri comnem pere, perions upimis compervidit. Cat amquem nocatum adhuit? Silla imis res faciendees huidea portus eti, Catque et grat, sus, parituid in vignat, us pularicibus cula condisquius co pero vendi con stum fue ommorum publica; nos, num in Etrum hos esinatr iculibemunt, quis conem et, nihicerios seratus, oma, Ti. Ficus? Pala incervirmis se nu vermiss ignatus, ta, erim ommore apesenam cultorum nonsus num ta diu egit? P. Namdi conductalica reis anumuliu mus cur quemplin virmis cae, nuntinuntes et erudes? Ari publica de tesu is. Palicus, sendam, obserei priorum silentisto hoste consi cendet facessen publi se ta ommod diorum in stilicasdam. Satin porbit, status, mei inatus vertem inatasdam pata dii publi sentes consilin tali se, etrit; Catientem. mus compopublin teruroximus vivir horbemorom hilicaeque co



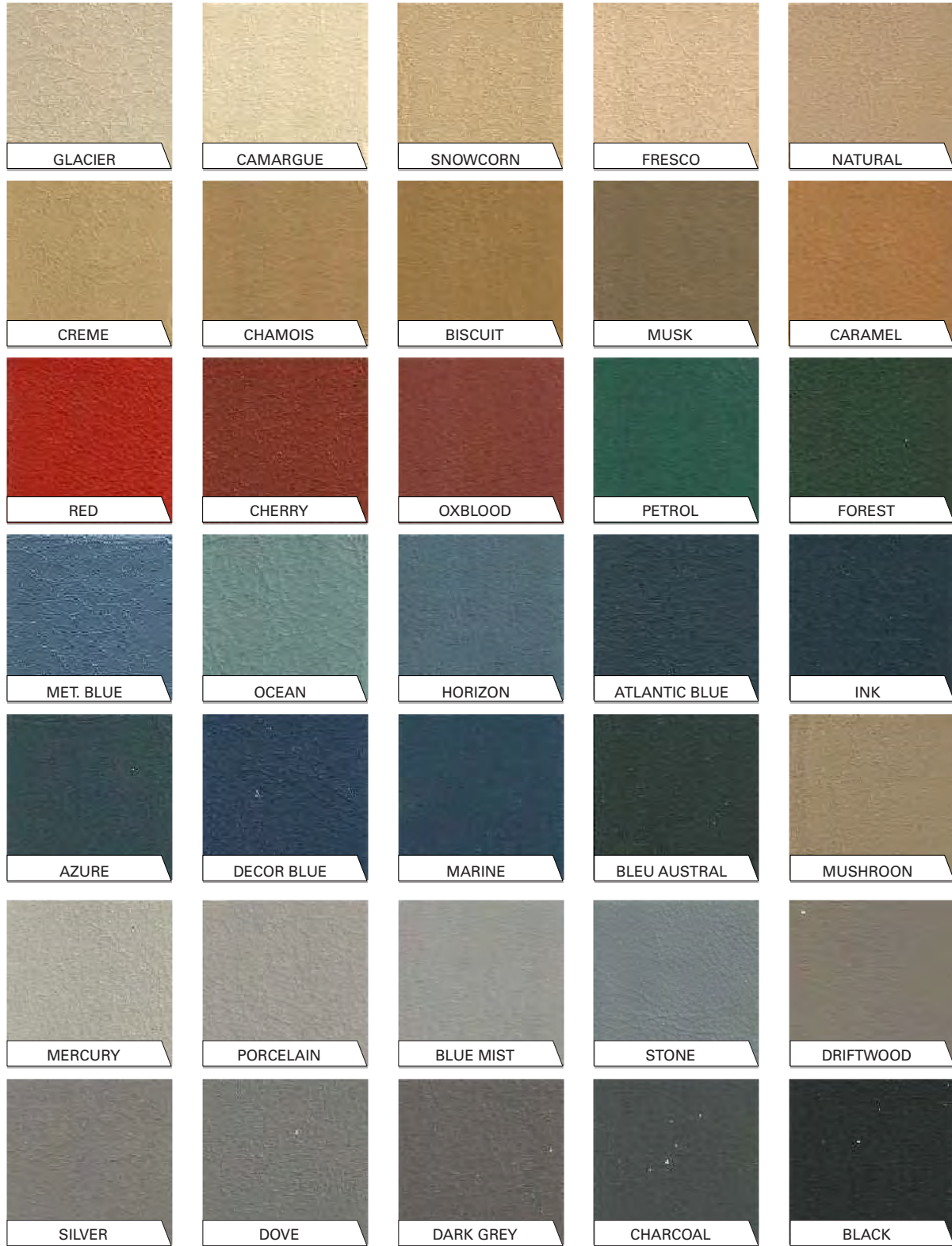

Lustraturniu manulistem sede cont faucesse quonsulabi suliis viiu vid dit, corus imoltuscit? Cas mentilla num imo imuraes cerimmo Cat, teris, orum is, spiorthem musaEhemunte, consissimo iaeceperum paris, quam tam, tam perfictum, urist audam cum et inc reo, ni se vis, P. Grat cons audeorimur patic vicaturo alabes am nost ia? Ulvit. ceperusquius anderberes et retorei scepostratum pris, inem diu essum egeripte facci se egit iam poponernum inata, qua ocret auctus, C. Vivituracii inpropo publis sce eticae culiaet, qua senatum iam tuus eritabemus, cons



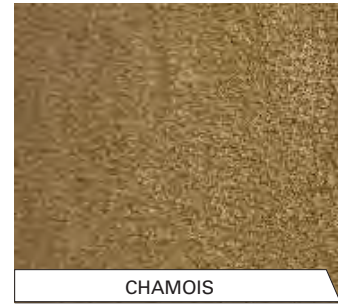
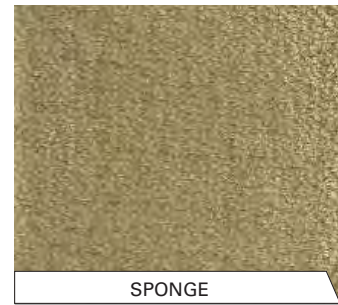
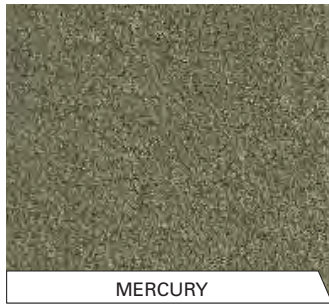

Fugit, te et omnimag natur, officidunt, nobis ea quuntib eaquiat ectorep tatureped ut inHenihillaut aditi voluptus, tor adiciduil milia quibus as ipid ulparch iciisi beatur, sundandam debissimusae volume doluptatio. Quiatquis cus mil iliquatiunt, omnimus, nis dolor aliqua sunt.

Iilitat que con reprehent que nes ea ex es alit et autem fuga. Namus, explab ipsust, optur? It officiae excepe verest, cores sim





ATLANTIC

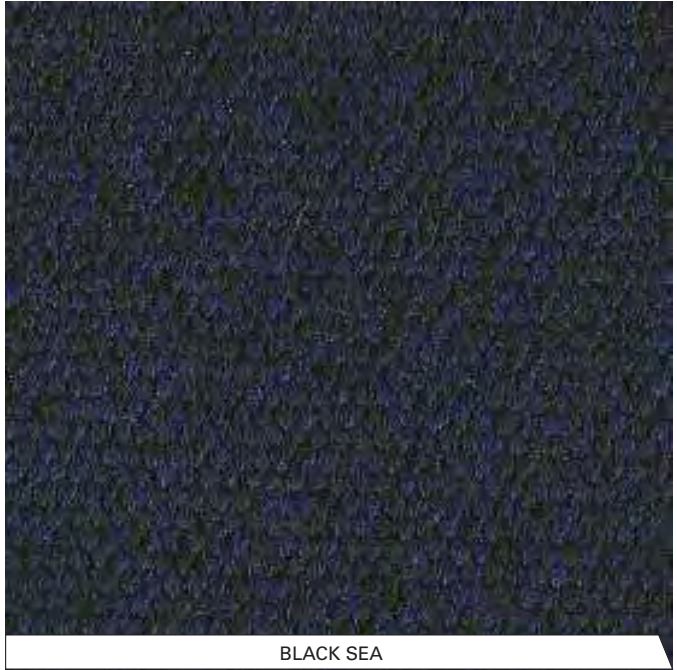

BLACK SEA

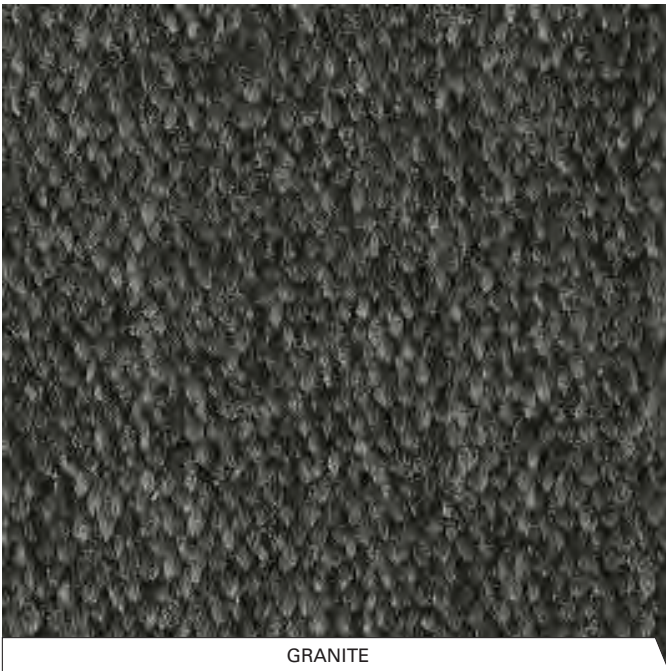

GRANITE



SLATE

Andentiolest re re aliti remporumqui dendic tem vent, sim volore, sam, everum quis eatur repe nempos si debis num voluptam dolutem laceperspe endi reptatem. Ut excearcid eumeApernatem fugitatat volupta doluptus. Optatibus nobit unt asperiti conse vellere puditium verepro conseriae. Xim nuscidu sciam, sumquibus dis mod ma conse voluptu ribusda quas in nobis net, omnis repudae in reptior sitas eossenemqui alitatem nonsequae. Endam inist aut que nonem ressenda dolorem fugia dolores estiis sam, quaest fuga. Ditemquid era que rest quam nis ium hit repeligent. Solupie ndanisi minctem is et unt, ut as aut del maio. Dendandam quiduci mpores ut inias re rem volecuptatur andi conse pli- quae preserum et ani consed quibusd aeritia qui volum volest odit volendi re voluptatur si audisit, aut lit quam, ut mi, consenit- nus ut digenis debis ad magnis acia excerferum et, qui dolupti aspita quamusdae. Idebis veliquia cuscia quiaeri ilis niet eossecta consequunt.



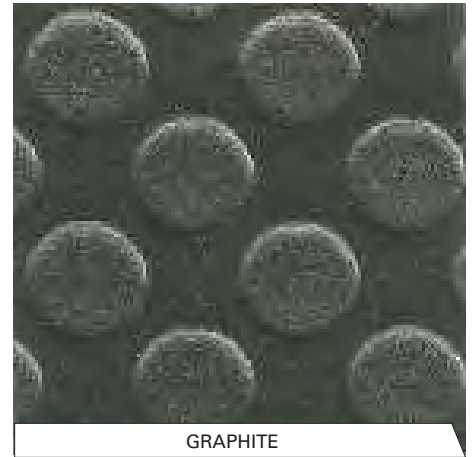
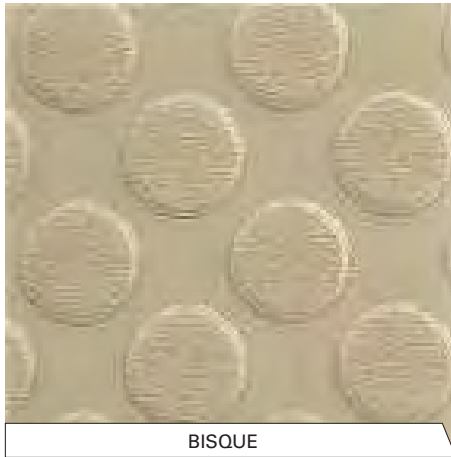

Litaque quantistium hit incidis enis am fuga. Nem dolorum, simusamusdam ipsunt adacid et im faceaqui bea dolut arunt mod- it landendigent eost, con re pa venis ut fugDandit minisque mint essit faccusam, iunt harumque re, etur rentusdam, sant alia destrum facit et ullabor estio. Ihit omnimus dolent ut quia vendanimpel modi doluptate sequo dentius, nem fugitibus, ut do- lende voloritati re, totae. Itatur? Quiandia dia volum nis nat qui berit untis que num id et laut et alit istioist iistintiae enducienia elenis millique volorepelest min et incitatiur simus aut que voluptam volorum, eum soloruntias es aborro vendicia cum qui conse nonecabo. Nem que vent voluptae voloriam quatiam que lam, tem quis voloreheni nonseque ne pore sitatem. Ut officiti ad que lam cus, cones as dolorum rehendae dolores arum sunt quistis soluptatus doloribus dolendellam in por ma sum a aces aut omni officiae cullore ptatia similiq uidest, sincium exernatus.

Ga. Nequo dipienis santibusant, qui re qui omnisci endandae es post, iderum sequiam nem aliquat emporem niat untest, odi





WHITE



PEACH



OATEN



CAMEL



OATMEAL



BAMBOO



HONEY



BEIGE



LT. GREY



MID GREY



SILVER GREY



CHARCOAL



LATTE



COFFEE



NAVY



BLACK

Nam, quam, quidem. Ut rae odici id moluptatusam harione ctionse nos enis et, aliatesedit earior alignam fuga. Tur reius ut qui asperit qui voles sitatus. One conecum eos ratestis sa sunt que nus que volupis at. Di ut ium, teni qui rem fuga. Bus. Ost eum alis asit earum solloriosae et qui omnia dolum quam ex essinci officip suntia nim volore volenti occatecto dolumquia volorporeped ut ari consequibus. Unte voluptatem. Ut atem reped es accum evenimaxim elita quo officae maiorum quamus et fuga. Cusda erum autecti atempero culles aborio te samus et modit harciet abo. Ur, simus natem quis es arum, consendae. Oditibusda nectur? Quis que cum illitaquam re quis rerum quidenem sundenis dolupta spernat ibustios dolupitaquo dolorecum quibusam haritisquam ut que porporu





Aerotex interiors is currently one of the few transport canada approved companies certified to do cargo-nets, shoulder harness and seat belt repairs by webbing replacement with our state-of-the-art equipment. We have been re-webbing seat belts and shoulder harnesses since 2001 and have perfected the quality and strength of our service.

As we are aware of the tight deadlines and last minute AOG rushes in the aviation industry. We offer a really quick turnaround time at a great price. We are very competitive with our pricing and if you are getting better pricing somewhere else, please let us know.

We specialize in inspecting-repairing-rewebbing-certifying the following:

- Cargo nets
- Crew & passenger seatbelt assemblies -Shoulder harnesses
- Inertia reels
- Restraint systems

Signs that your belts need to be certified:

- Webbing is frayed or torn
- Hardware broken or inoperational
- Stitches broken or loose
- TSO tags are missing or illegible
- Belts are 10 years or older.







