



# Pagoda

008.001.006.001



blue rabbit

© 2016

Blue Rabbit 2.0 - Hemelrijken 8 - B-2890 St-Amands - Belgium.  
Copyrighted material - Do not reproduce under penalty of law.

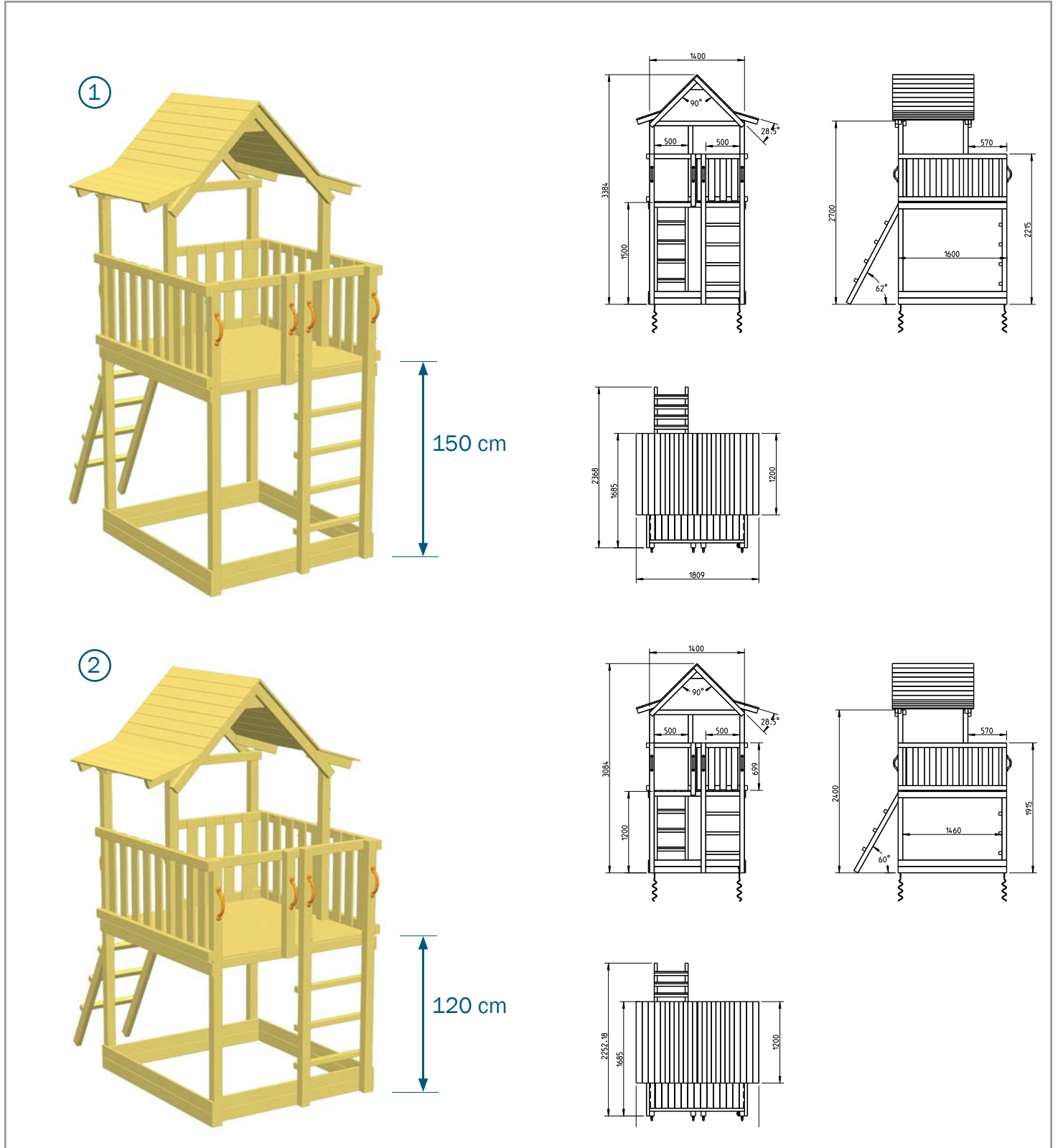

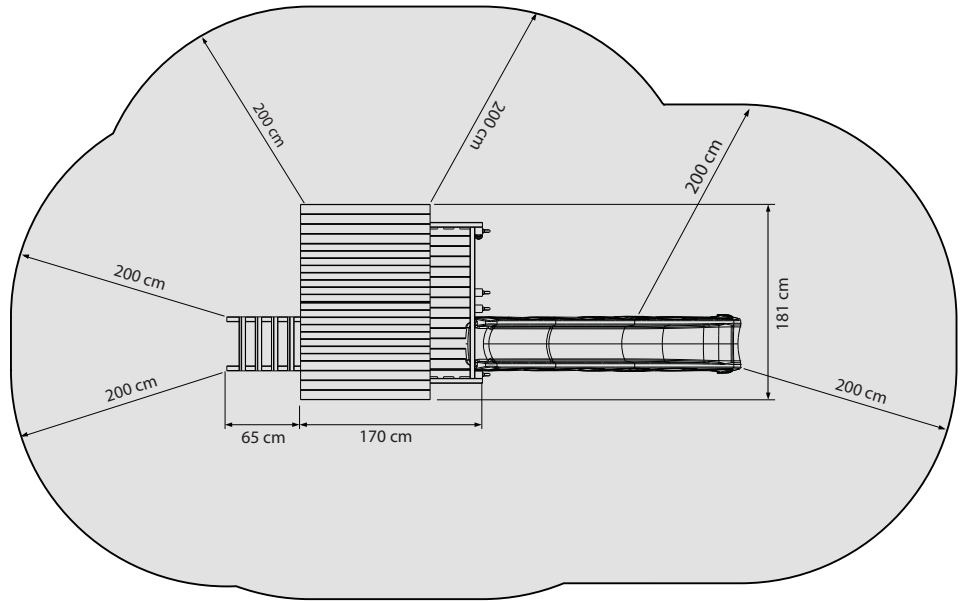
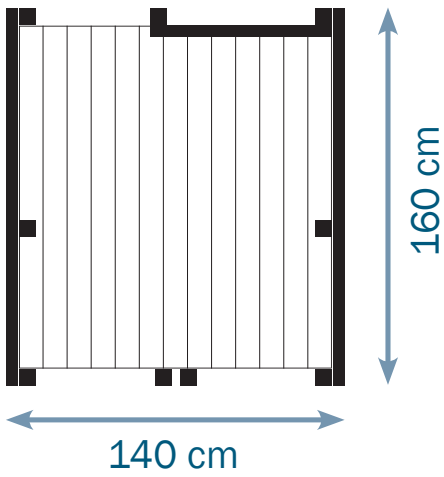







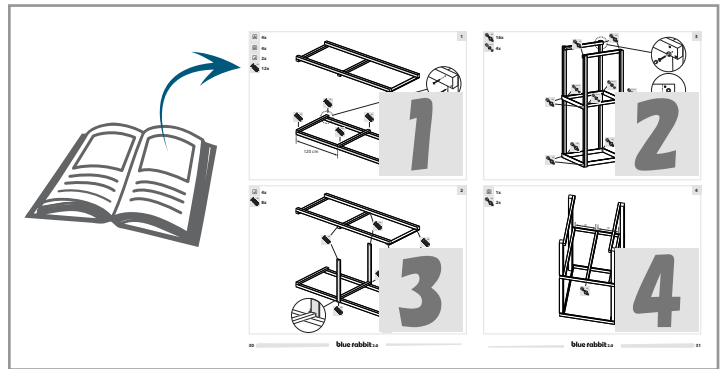
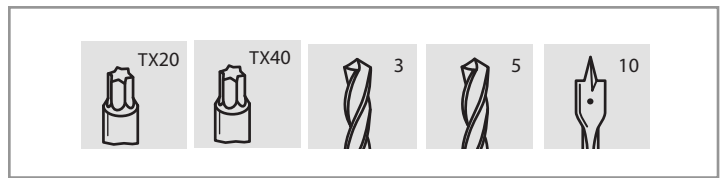
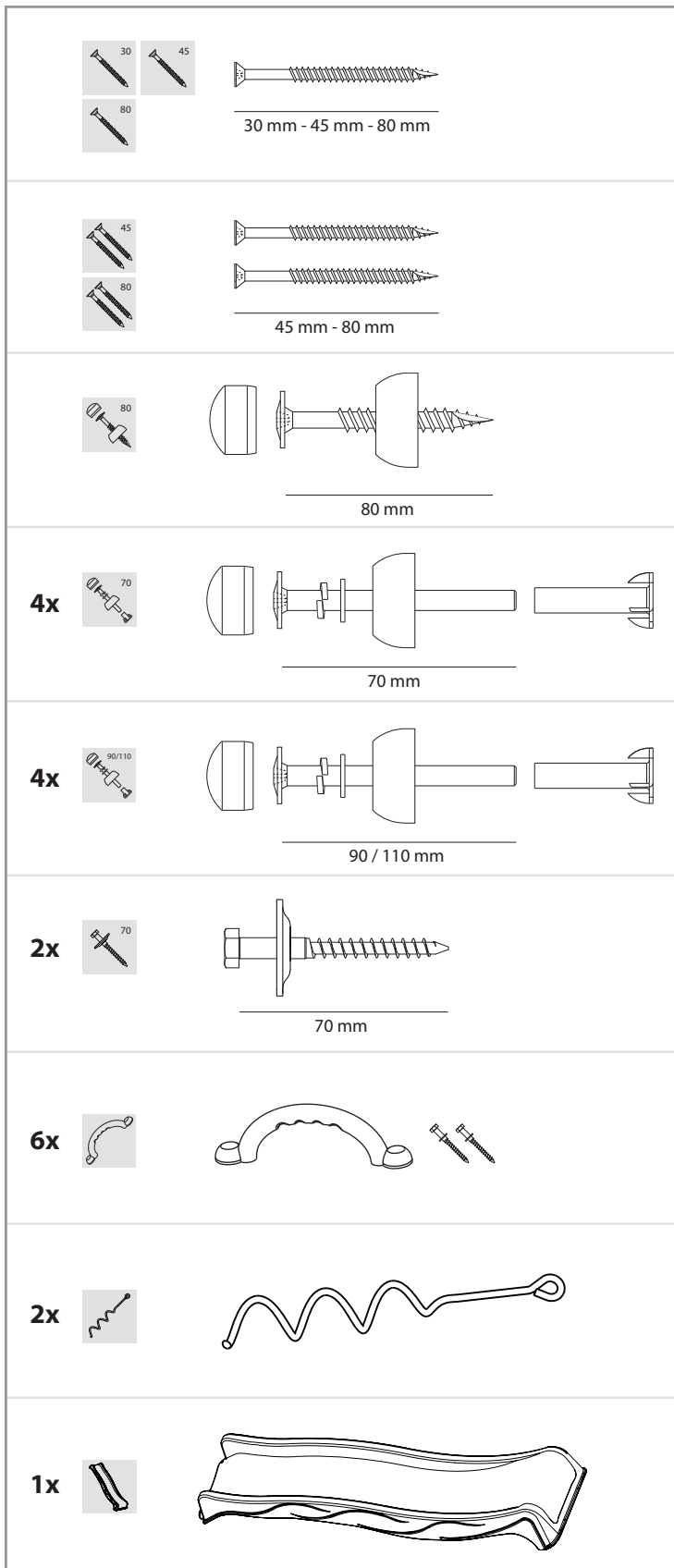



















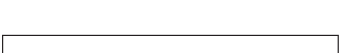











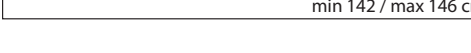

								<b>@ramp</b> 008.003.002.001 	<b>@challenger</b> 008.003.007.001 
		<b>@platform</b> 008.003.006.001 	<b>@net</b> 008.003.003.001 	<b>@bridge</b> 008.003.004.001 	<b>@steps</b> 008.003.008.001 	<b>@wall</b> 008.003.001.001 	<b>@swing</b> 008.003.005.001 		
<b>Pagoda</b> 008.001.006.001 	150 cm X    B    C							I   II   III   IV X	
	120 cm B    C    X							X    I   II   III   IV	

53 x 28 x 11 cm    6,3 kg

78    120 x 80 x 158 cm    516 kg



- 2x** **A** min 68 mm | max 90 mm  
  - min 68 mm
  - max 90 mm
- 3x** **B** min 68 mm | max 90 mm  
  - min 68 mm
  - max 90 mm
- 1x** **C** min 68 mm | max 90 mm  
  - min 68 mm
  - max 90 mm
- 2x** **D** min 68 mm | max 90 mm  
  - min 68 mm
  - max 90 mm
- 1x** **E** min 68 mm | max 90 mm  
  - min 68 mm
  - max 90 mm
- 2x** **F** min 68 mm | max 90 mm  
  - min 32 mm
  - max 50 mm
- 4x** **G** min 68 mm | max 90 mm  
  - min 32 mm
  - max 50 mm
- 5x** **H** min 68 mm | max 90 mm  
  - min 32 mm
  - max 50 mm
- 2x** **I** min 68 mm | max 90 mm  
  - min 32 mm
  - max 50 mm
- 2x** **J** min 68 mm | max 90 mm  
  - min 32 mm
  - max 50 mm
- 2x** **K** min 68 mm | max 90 mm  
  - min 32 mm
  - max 50 mm
- 4x** **L** min 68 mm | max 90 mm  
  - min 32 mm
  - max 50 mm
- 3x 4x** **M** min 44 mm | max 45 mm  
  - min 44 mm
  - max 45 mm
- 3x 4x** **N** min 44 mm | max 45 mm  
  - min 44 mm
  - max 45 mm
- 6x** **O** min 95 mm | max 145 mm  
  - min 15 mm
  - max 22 mm
- 10x\*/15x\*\*** **P** \*\* min 95 mm | \* max 145 mm  
  - min 15 mm
  - max 22 mm
- 4x** **Q** min 95 mm | max 145 mm  
  - min 15 mm
  - max 22 mm
- 16x\*/24x\*\*** **R** \*\* min 95 mm | \* max 145 mm  
  - min 15 mm
  - max 22 mm
- 15x\*/20x\*\*** **S** \*\* min 95 mm | \* max 145 mm  
  - min 15 mm
  - max 22 mm
- 2x** **T** min 95 mm | max 145 mm  
  - min 15 mm
  - max 22 mm

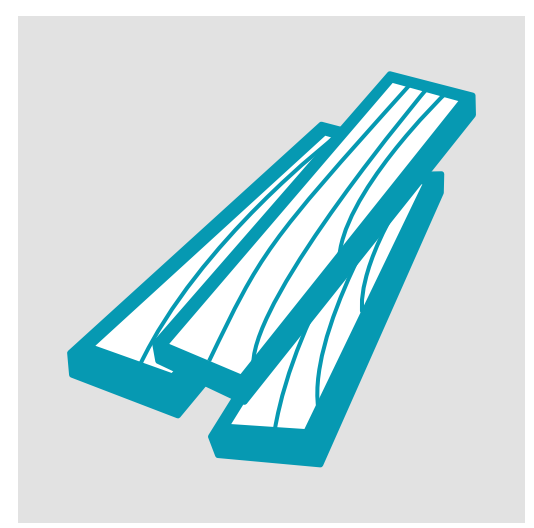
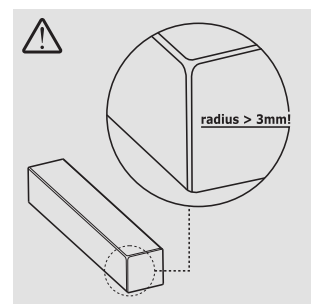
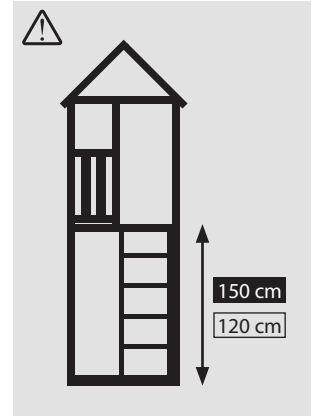



---

Blue Rabbit 2.0®  
Hemelrijken 8  
B-2890 Sint-Amands  
BELGIUM

[info@bluerabbit.be](mailto:info@bluerabbit.be)

[www.bluerabbit.be](http://www.bluerabbit.be)