

A few simple steps to ensure
perfect water, every time.



Use and Care Guide

MODELS: A4BLWTRCLR

Registration

Please visit the website below to register your new water cooler within the first 30 days of purchase. Registration within the first 30 days will activate your one year warranty.

www.avalonh2o.com/register-my-avalon-cooler

Please keep your model number, order number and purchase date for future support. You can reach us at 1-800-256-0695.

Model Number _____

Order Number _____

Purchase Date _____



Conforms to NSF/ANSI 372

Contents

About Your Water Cooler

Meet Your Avalon Product	1
Part Names	2-3
Indicator Lights	4
Tech Specs	5

Getting Started

Unpacking your Avalon Water Cooler	7
Install Water Bottle	8-9
Install/Remove Drip Tray	10
Powering the Dispenser	11
Activate Heating and Cooling	12

User Guide and Maintenance

Dispensing Water	14
Changing the Bottle	15-16

Cleaning

Rinsing, Cleaning, and Draining	18-20
Cleaning	21-22

Troubleshooting

Safety

Meet Your Avalon Product



Child Safety Feature

Ensures safe hot water flows for the entire family



Energy Star Approved

Saves the environment and your wallet



Built-in Nightlight

Makes late night water trips a breeze



UL Listed

We design & manufacture with your safety in mind



Attractive Design

Attractive stainless steel design with 3 water spouts



Custom Temperature

Piping hot, room temperature or crisp cold water



Bottom Loading

No more lifting, flipping or spills



Empty Bottle Indicator

Notifies you when your bottle is empty

Part Names

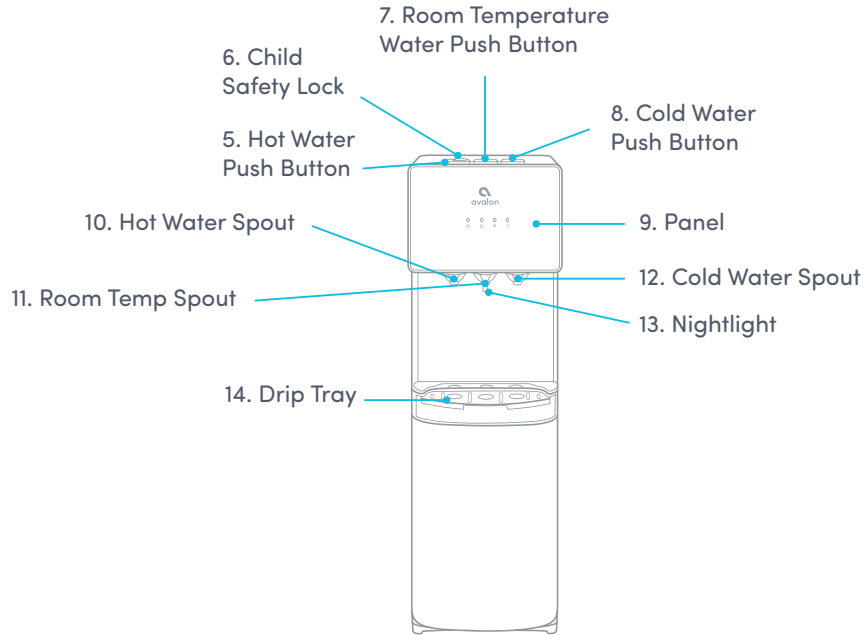
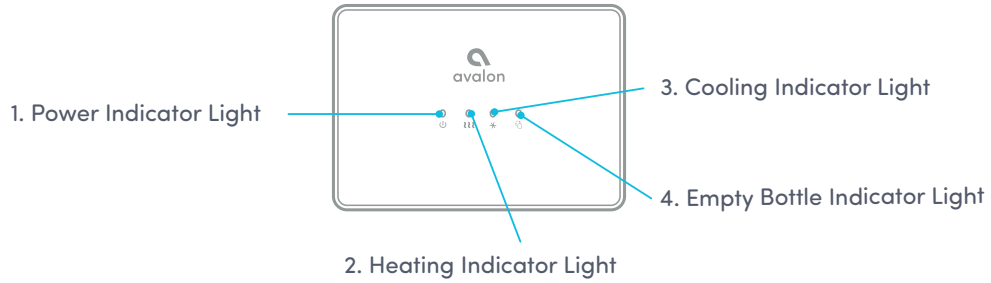

Part Names

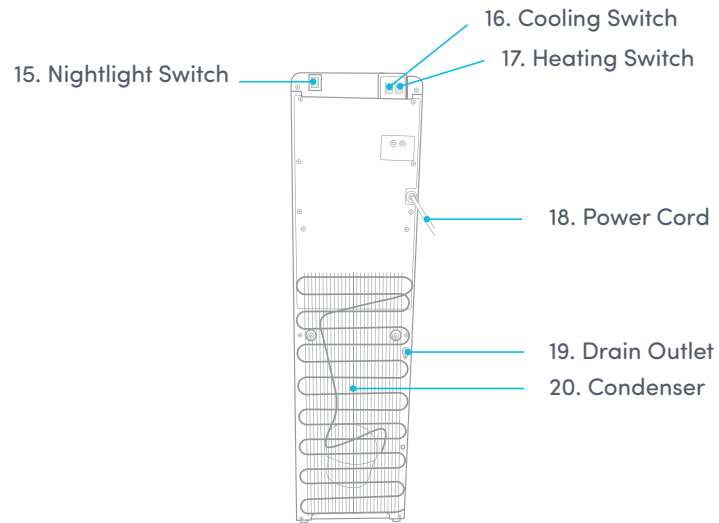

Indicator Lights

Power Indicator Light



This light will remain on as long as the water cooler is plugged in to indicate that the cooler is on.

Heating Indicator Light



This light will indicate when the water is heating. The light will remain on while the water is heating and will turn off when it has reached the correct temperature of 185°F. As the water is dispensed the hot tank will refill and the water will heat. As the water reheats this indicator light will turn on.

Cooling Indicator Light



This light will indicate when the water is cooling. The light will remain on while the water is cooling and will turn off when it has reach the correct temperature of 47°F. As the water is dispensed the cold tank will refill and the water will cool. As the water cools this indicator light will turn on.

Empty Bottle Indicator Light



This light will indicate that the bottle below is empty and will need to be replaced. This red light will begin to blink to alert you of the empty bottle.

Tech Specs

Model	A4BLWTRCLR
Hot/Cold/Room Temp Output	1.2L/min / 1.2L/min / 1.0L/min
Hot Water Capacity	4 L/H (≥ 185°F)
Hot Tank Volume	1.16 Liters
Cold Water Capacity	2.5 L/H (≤ 47°F)
Cold Tank Volume	3.6 Liters
Product Size	13"(L)x12"(W)x41"(H)
Packing Size	16"(L)x15"(W)x45"(H)
Net Weight/Gross Weight	36.15 lb /46.5 lb
Voltage/Frequency	115 V 60Hz
Cooling Method	Compressor
Heating Method	Internal Element
Heating Watts / Cooling Watts	420W / 100 W
Power Consumption	520 W

Getting Started

Unpacking Your Avalon Water Cooler

The unit has been cleaned prior to departing from the factory. To remove any dust and debris that may collect during shipping we recommend cleaning the unit prior to installation. For cleaning instructions, see pages 18-22.

Locating Dispenser

Do NOT plug in the power cord yet.

Place dispenser upright on a hard and level surface in a cool and shaded location near a grounded wall outlet. Position the dispenser so there is about four inches of clearance from the wall on the back and both sides.

Unpack the machine, open the cabinet to remove the drip tray, and install it by inserting it into place at the top of the cabinet door, see page 10.

Installing the Water Bottle

1. Open the cabinet door.

2. Place the probe assembly on the probe hanger



3. Place a fresh bottle outside of the cabinet.

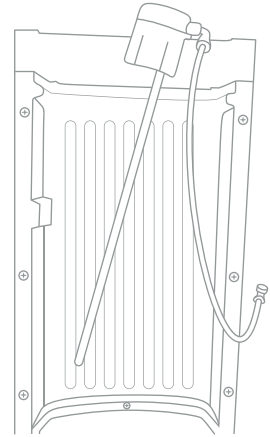

4. Remove the entire plastic cap from the top of bottle.

5. Clean the outside of the new bottle with a cloth.

Installing the Water Bottle

6. Place the probe into the bottle.

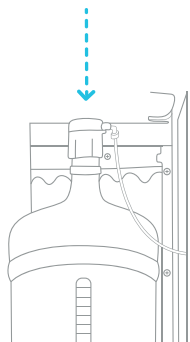

7. Slide the collar down until it clicks into place. If you are using a 3 gallon bottle rather than a 5 gallon bottle you can adjust probe by pressing the two tabs at the head of the probe and sliding the collar down to the neck of the bottle.

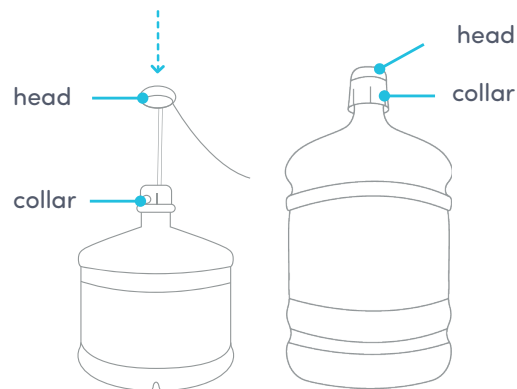

8. Push the head down until the tube hits the bottom of bottle.

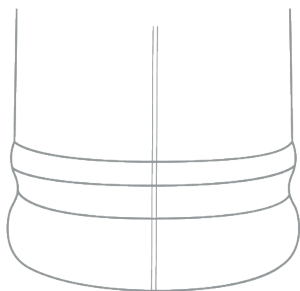

9. Slide the bottle into cabinet and close the door.

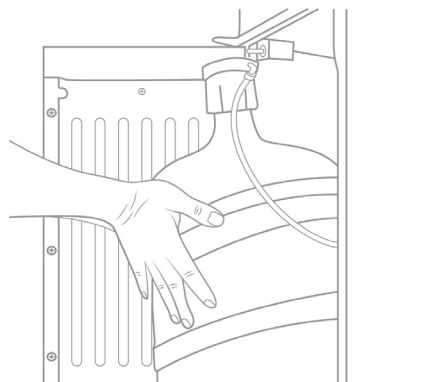

Installing and Removing the Drip Tray

No external drain is needed, the overflow will collect here. The red float will rise to indicate when the drip tray needs to be emptied.

1. To install the drip tray, simply slide it into the area at the top of the door until it snaps into place.

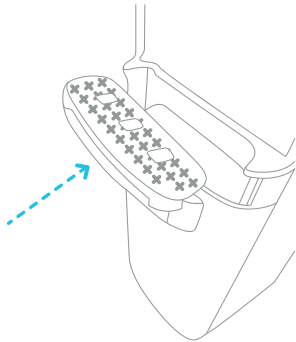

2. To remove the drip tray, place your fingers in the grid of the drip tray with one hand and hold the door of the cooler shut with the other.

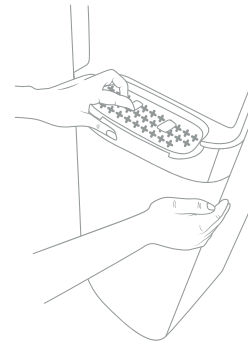

3. Gently pull the drip tray toward you to release it. Once it has been released you can remove the drip tray from the door of the cooler to empty it.

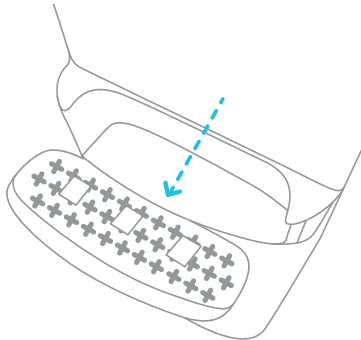

Powering the Dispenser

Plug cord into a properly grounded wall outlet. At this time the pump will begin to move water from the bottle to the hot and cold tanks. It will take up to 12 minutes to fill the tanks for the first time. During this period the pump will run continuously. This is normal.

Activate Heating and Cooling

Before turning on the heating (#17) or cooling (#16) switches, ensure water is already filling inside the inner tanks by dispensing a drop of water from the hot (#10) and cold (#12) spouts.

To activate the cold water, push the cooling switch (#16) into the on (I) position by pushing the top of the switch in. If you do not wish to have cold water you can leave the switch in the off (O) position.

To activate the hot water, push the heating switch (#17) into the on (I) position by pushing the top of the switch in. If you do not wish to have hot water you can leave the switch in the off (O) position.

Please allow 15 minutes for the hot water to be heated. During this time the heating indicator light (#2) will be steady. The light will turn off when the heating process is complete. Please allow 1 hour for the cold water to be cooled. During this time the cooling indicator light (#3) will be steady. The light will be turned off when the cooling process is complete. If any error occurs in the heating or cooling process, the indicator light will blink.

User Guide and Maintenance

Dispensing Water

Cold Water

Once you have turned the cooling switch (#16) into the on (I) position it will take initially 1 hour for the water to cool. During this time the cooling indicator light (#3) above the cold water icon will be steady. During this time the compressor could run continuously. This is normal. The light will be turned off when the cooling process is complete.

1. Position a bottle, glass, pitcher or cooking pot below the cold water spout (#12).
2. Depress the cold water push button (#8) downward to begin the flow of water.
3. Once the desired fill level is achieved release the cold water push button (#8).

Room Temperature Water

1. Position the bottle, glass, pitcher or cooking pot below the room temperature spout (#11).
2. Depress the room temperature water push button (#7) downward to begin the flow of water.
3. Once the desired fill level is achieved release the push button (#7).

Hot Water

Once you have turned the heating switch (#17) into the on (I) position it will take initially 15 – 20 minutes for the water to heat up. During this time the heating indicator light (#2) above the hot water icon will be steady. The light will be turned off when the heating process is complete.

1. Position a bottle, glass, pitcher or cooking pot below the hot water spout (#10).
2. Slide the red child safety lock (#6) to the left and depress the hot water push button (#5) downward to begin the flow of water. You must hold the child safety lock (#6) and push the button at the same time.
3. Once the desired fill level is achieved release the hot water push button (#5).

Changing the Bottle

When the empty bottle indicator light (#4) is flashing red this is an alert that your bottle is empty and will need to be replaced as soon as possible.

Notice: Do not dispense hot, room temperature or cold water if the light is flashing as you could empty the tanks and cause the dispenser to overheat.

1. Open the cabinet door.
2. Slide the empty bottle out of the cabinet.
3. Remove the probe assembly from the empty bottle. Place probe assembly on the probe hanger.
4. Set the empty bottle aside.
5. Place a fresh bottle outside of the cabinet. Remove the entire plastic cap from the top of bottle. Clean the outside of new bottle with cloth.

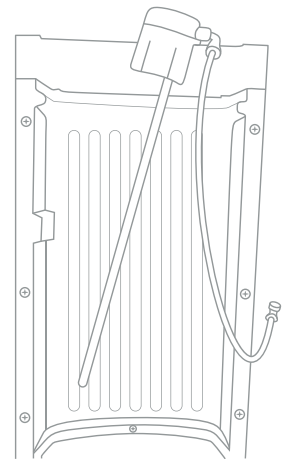

Changing the Bottle

6. Place the probe into bottle. Slide the collar down until it clicks in place. Push the head down until tube hits the bottom of the bottle.

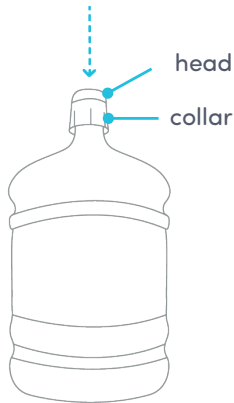

7. If you are using a 3 gallon bottle rather than a 5 gallon bottle you can adjust probe by pressing the two tabs at the head of the probe and sliding the collar down to the neck of the bottle.

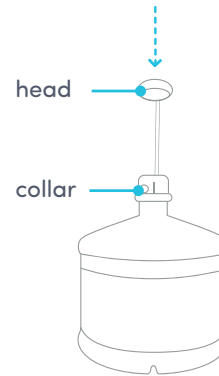

8. Slide the bottle into cabinet and close the door.

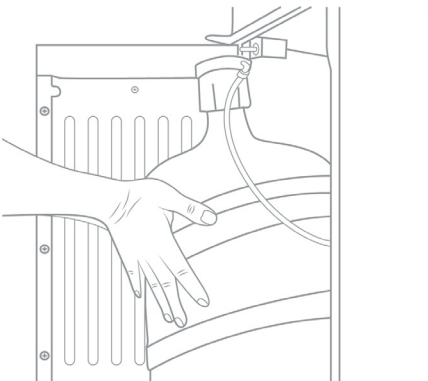

Cleaning

Rinsing, Cleaning, and Draining

To prolong the lifetime of the machine, it is recommended that the unit be cleaned and sanitized manually about every six months.

To clean the outside of the unit

Use a disinfectant of your choice to wipe down the outside of the machine. Disinfectant does not come with this unit. It can be purchased separately from a local store.

To rinse the inside of the unit

The machine has been disinfected prior to departing from the factory. However, it is recommended to rinse and drain the unit prior to installation.

1. Before cleaning, make sure that the cooling switch (#16) and heating switch (#17) are in the off (O) position and unplug the machine.



2. Remove the two screws located on the back (at the top, in line with the switches) of the cooler. Remove the top cover by lifting at an angle and pull off. Remove the white cold water tank cover and the separator.

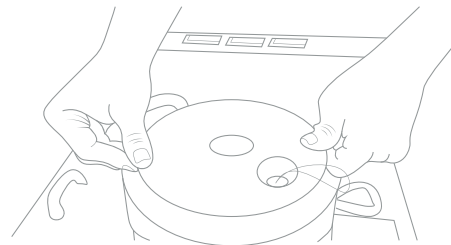
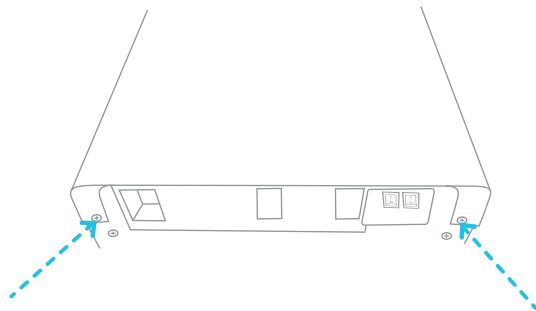

Rinsing, Cleaning, and Draining

3. Pour 0.6 gallons of clean water into the cold tank. (The cold water tank is the open cylinder that the white cover was removed from).

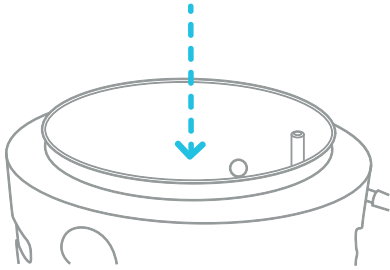

4. Place a large bucket beneath the drain outlet (#19) located on the back of the unit. Remove the drain cover and allow the water to drain from the unit. Water will start flowing as soon as the drain cover is removed.

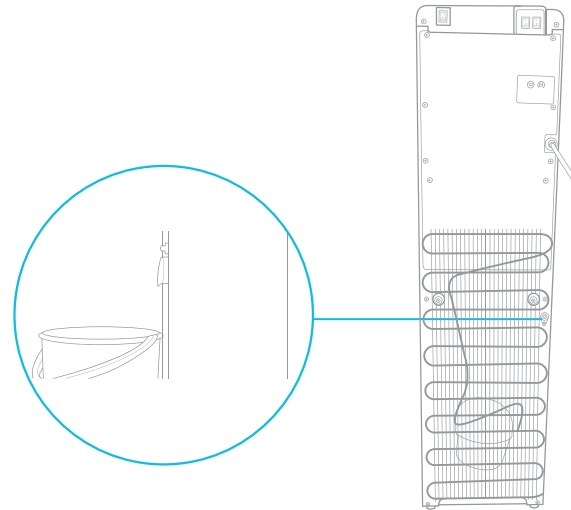

Caution: The dispenser will heat water to a temperature of approximately 185°F. It can cause severe burns if not handled carefully. Please use caution while operating and cleaning. Please allow ample time for any hot water inside the machine to cool down before draining it.

Rinsing, Cleaning, and Draining

5. Once water is completely drained, reposition the drain cover, cold tank cover and the top cover. Ensure that the pipes and wires are connected properly and you may use the dispenser as normal.

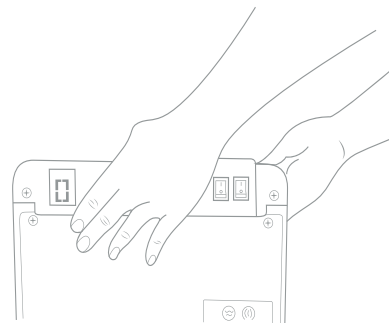
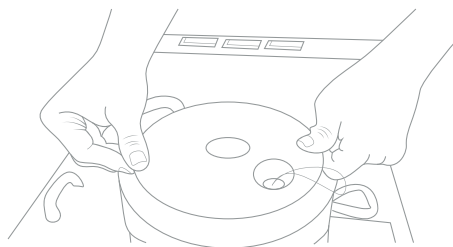
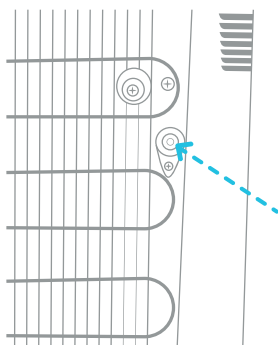

Cleaning

To remove mineral deposits that may have built up inside the the cold tank, mix 4 L of water with 200 g of citric acid crystals (not included) or cleaning solution of your choice.

1. Unscrew the top cover and lift off the cold tank lid.

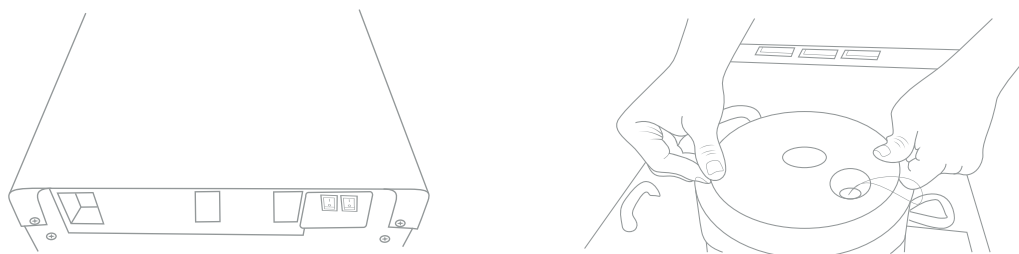

2. Put the mixture into the machine's cold tank and make sure the water can flow out of the hot water spout (#10).

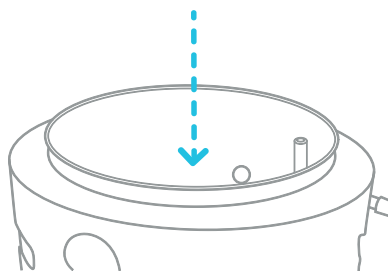

Cleaning

3. Plug in the power cord and turn on (I) the heating switch (#17). Allow the water to heat for 15 minutes.

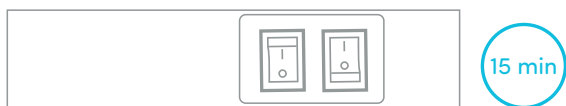

4. Turn off (O) the heating switch (#17) and allow the liquid mixture to cool down for 20 minutes.

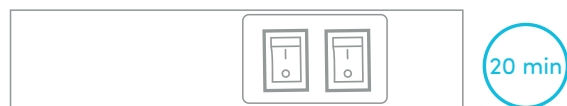

5. Drain the liquid from the drain outlet (#19), then flush with water two or three times by following the rinsing instructions above. Only disassemble parts mentioned to avoid damaging the machine.

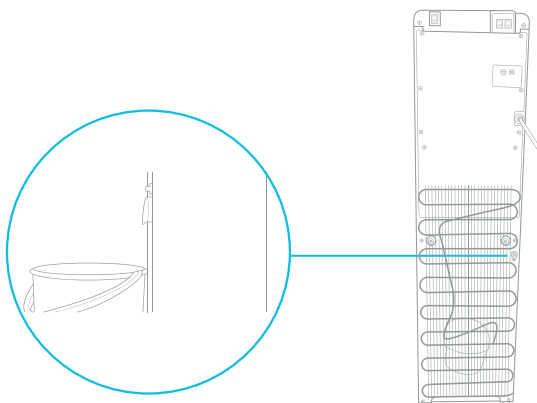

Troubleshooting

Troubleshooting

If you are having trouble with your water cooler please see the following solutions. You can also view our trouble shooting videos at the website below. Please feel free to contact us with any questions.



1-800-256-0695



support@avalonh2o.com



www.avalonh2o.com

Troubleshooting

Water is leaking in the unit

Please check to see that all of the connections are tight and there are no loose tubes or connections.

Water not dispensing at a hot or cold temperature

This could be caused by an over consumption of water in a short period of time causing the tanks to empty. Please allow 5 to 10 minutes for the water cooler tanks to refill. Allow the proper time for the water to heat and cool.

This could be caused by an interruption in the power supply. Please ensure that the power cord is connected to an outlet. Please make sure that the heating (#17) and cooling (#16) switch are in the on position.

No water is dispensing from the spout

- Check to make sure that the bottle is not empty. If it is, please replace it with a new one.
- Make sure to completely depress the push button controls and the child safety lock is being slid away from you and held in place while depressing the button.

Not pumping water after replacing the bottle

- Please make sure that the cabinet door is closed. The door must be closed for the water to pump. Please unplug the water cooler and check all of the connections in the bottle cabinet. It is possible that a connection became loose while moving the bottle. Even a slightly loose connection can cause the cooler not to function properly.

Night light is not working

- Check to make sure the power cord is properly connected to a working outlet.
- Check to make sure the nightlight switch (#15) is in the on (I) position on the back of the dispenser.

Dispenser is very noisy

- Please make sure that the dispenser is positioned on a flat, level surface.

Safety

Safety

To reduce risk of injury and property damage, user must read this entire guide before assembling, installing and operating the dispenser.

Failure to execute the instructions in this manual can cause personal injury or property damage.

This product dispenses water at very high temperatures. Failure to use this properly can cause personal injury.

When operating this dispenser, always exercise basic safety precautions, including the following:

- Prior to use, this dispenser must be properly assembled and installed in accordance with this manual.
- This dispenser is intended for water dispensing only. Do NOT use other liquids. Do NOT use for other purposes. Never use any other liquid in the dispenser other than known microbiologically safe tap water.
- For indoor use only. Keep water dispenser in a dry place away from direct sunlight. Do NOT use outdoors.
- Install and use only on a hard, flat and level surface.
- Do NOT place dispenser in an enclosed space or cabinet.
- Do NOT operate the dispenser in the presence of explosive fumes.
- Position back of dispenser no closer than 20 cm from wall and permit free airflow between wall and dispenser. There must be at least 20 cm clearance on the sides of the dispenser to permit airflow.
- Use only properly grounded outlets.
- Do not use an extension cord with your water dispenser.
- Always grasp plug and pull straight out from outlet. Never unplug by pulling on power cord.
- To protect against electric shock, do NOT immerse cord, plug or any other part of the dispenser in water or other liquid.

Safety

- Ensure dispenser is unplugged prior to cleaning.
- Never allow children to dispense hot water without proper and direct supervision. Unplug unit to prevent unsupervised use by children.
- Service should be performed only by a certified technician.
- Warning: Do not damage the refrigerant circuit.
- This appliance can be used by children aged from 8 years and above if they have been given supervision or instruction concerning use of the appliance in a safe way and if they understand the hazards involved. Cleaning and user maintenance shall not be made by children unless they are older than 8 and supervised. Keep the appliance and its cord out of reach of children less than 8 years.
- Appliances can be used by persons with reduced physical, sensory or mental capabilities or lack of experience and knowledge if they have been given supervision or instruction concerning use of the appliance in a safe way and understand the hazards involved. Children shall not play with the appliance.
- This appliance is intended to be used in a household and similar applications such as: kitchen area in shops, offices and other working environments, bed and breakfast type environments, catering and similar non-retail applications.
- Do not store explosive substances such as aerosol cans with flammable propellant in this appliance.
- If the supply cord is damaged, it must be replaced by a special cord assembly available from the manufacturer or its service agent.
- Never turn the machine upside down or lean it more than 45°.
- Thermostat has been adjusted. There is no need to adjust it by yourself. When the matching is below the freezing point and blocked by ice, the cooling switch should be turned off for 4 hours before turning it on again to continue its operation.
- This machine should not be plugged back in until 3 minutes after it has been unplugged.