



EMCO TECH CO.,LTD.

IonWays Associate

Owner's Manual
for your new

DELPHI



Warning: Incorrect installation and/or operation could void your valuable warranty.
Please protect your investment! READ THIS MANUAL CAREFULLY

 EMCO TECH CO.,LTD.

CONGRATULATIONS ON YOUR NEW PURCHASE!

You have just purchased the finest, most advanced water system in the world! Your new Delphi undersink ionizer is designed to provide you with many years of the cleanest, healthiest and most "functional" water available.

Your new Delphi undersink is the only fully remote faucet that allows you to get both alkaline and acidic water at the sink. There are many specific uses and benefits of this amazing water, so read this manual carefully to learn how to get both optimum performance out of your ionizer and to protect your investment.

Your new Delphi undersink produces filtered alkaline, ionized water. Just exactly what is that? The Delphi undersink employs computer accurate and selectable magnetic energy to perform electrolysis through patented platinum bonded titanium electrodes inside a water cell. Inside this advanced cell, the magnetic energy separates the water into an alkaline (high pH) and acid (low pH) stream without using any chemicals. Ionizing the water in this way re-structures the molecules and reduces their cluster size, binds extra oxygen molecules, and concentrates ionized, absorbable and beneficial minerals like Calcium, Magnesium and Potassium.

Your new Delphi undersink also produces Acidic water. This type of water has a low pH (less than pH6) and has many excellent uses. You will now have the convenience and benefits of water that "functions" in many ways that ordinary tap, filtered or bottled water cannot.

TABLE OF CONTENTS

Description

Congratulations / Introduction	01-02
What is alkaline electrolyzed-reduced water?	03-04
Why the Delphi is the world's most advanced ionizer	05-06

Safety Precautions

Power Related	07
Installation Precautions	08
During Usage	09
pH Reagent Liquid Precautions	10
Some helpful tips	10

Installation, Use and Maintenance

Names and functions of Parts I	11-12
Names and functions of Parts II	13-14
How to Install	15-17
How to Use	18-21
How to Measure pH	22
How to set your individual pH levels	23-24
How to Add Calcium	25
Regularly check and clean your Pre-Filter	26
How to Replace the Filter	27-28
About your revolutionary Biostone Filter	29-30

Customer Service

Trouble shooting guide	31-32
Specifications / Faucet dimensions	33-34

What is alkaline electrolyzed-reduced water?

Alkaline/acidic electrolyzed-reduced water is "functional water". This water is first filtered then transformed through electrolysis to be higher in pH, hydrate more effectively, be highly oxygenated and act as a strong antioxidant.

Some uses for the different levels of Alkaline water



1

For initial consumption period (4-7 days). Let your body adjust slowly to the increase in pH. Many people find that this lower level is actually perfect for them.



2

After the adjustment period you can drink the water at this next level. This level is also great for cooking rice and other grains - fluffier and great tasting!



3

Some people like this for drinking though it can start to taste strong. It is superb for making tea or coffee as it enhances the taste and reduces bitterness!



4

Generally most people find this very strong tasting and with powerful detoxifying effects. Great for boiling vegetables! Alkaline water will eliminate the bitter taste and brings out more of their natural color.

What would I use the Purified water for?



The pH of Purified water is neither raised nor lowered and would be the same as your tap water. This water is simply cleaned of impurities by the advanced filtration system. You can use it both as drinking water and to take medications with.

Some uses for the different levels of Acidic water

The Acid water has both antiseptic and antibacterial properties. It also has an astringent effect and can be used for cosmetic purposes.



1

Use it while brushing your teeth, gargle with it and use it as a natural mouth wash!



2

It is an excellent astringent: use it for washing your face or as a natural after shave.



3

In the kitchen use it to help clean kitchen utensils.



4



This setting has sterilizing properties - use it to sterilize cutting boards, dish towels etc...

Precautions for use of Alkaline water - don't develop a "drinking" problem!

- If you have never consumed alkaline water - do not use a setting higher than 1 to begin with. Let your body adjust slowly and naturally for 4-7 days. After this initial adjustment period, you can gradually increase the alkalinity of the water.
- Do not take medications with alkaline water. Take medications only with purified water.
- Consult with a physician before drinking alkaline water if you have:
 - Chronic disease
 - A dysfunctional liver or intestines
 - Are currently under medical treatment
- Do not drink alkaline water if you have achlorhydria.
- Consult a physician before using acidic water if you have:
 - Sensitive skin
 - Allergies
- Only use potable drinking water in your ionizer.
- Poor water quality may have negative effects on your health and your ionizer! Most municipal water sources will be fine in your ionizer.
- Well water and water from smaller systems should be checked, and may require pre-filtering. Your ionizer is not under warranty for any damage or required cleaning caused by hard water deposits.

Safety Precautions

Please read these pages carefully. They contain very important information to keep YOU and your new Ionizer safe!

 Warning	Property damage, serious injury or death may result if these instructions and precautions are not observed.
 Caution	Physical injuries or material damage may be caused if the instructions are not observed.

Do's and Don't's

-  DO NOT  Do not disassemble it.  Disconnect the power cord from the wall outlet while using.
-  DO  Do not touch it.  Ground product for protection from electric shock.

Why the Delphi undersink is the world's most advanced ionizer

Your new Delphi undersink is the only fully remote faucet that allows you to get both alkaline and acidic water at the sink.



A revolutionary new automatic dynamic flow system employing patented SOL valves.

With the SOL valve system, your ionizer produces top quality alkaline water without the separate cleaning cycle of every other ionizer. The SOL valve system keeps desirable flow levels and pressure which prevents scale build up and protects from overloading the electrolysis cell. This feature also reduces the amount of flow from the Acidic drain line.



5-layered platinum-titanium electrodes

We use the most advanced platinum-titanium electrode plating process that consistently produces water with optimum ORP (Oxidation Reduction Potential) at the selected pH level.



Triple diaphragms

Unique diaphragms made of natural pulp coated with PE and processed with surfactants keep pH, ORP and ion exchanges between acid and alkaline uniform despite changes in pressure, flow amount or velocity. They prevent scale buildup by employing a new material called fremion.



Mountain range-like specialized electrodes

When a cross section of an electrode is examined at 700 times magnification, you can see that the electrodes have very sharp points and form valleys. Your ionizer employs special electrodes that generate reduced water with optimal ORP and stable pH level.



Top quality 9 step single-body nano-silver multi-stage filter

Premium filter materials ensure production of healthier and cleaner water, trapping a wide variety of contaminants while allowing beneficial minerals to pass through.



One-touch ON/OFF water supply

Unlike the ionizers with a manually controlled water supply, where users must constantly check the flow rate, your ionizer has patented SOL valves which automatically control the flow rate. This ensures you ease of use and optimal operation - no guess work involved!

Water selection and mode indicators



Your ionizer has an attractive colored FND display that easily identifies your selections.

Easy to understand symbols and colors identify the type and level of water you have selected on the machine.



Voice Indicator

A voice alerts you to your selection of alkaline, acidic or purified water. You can adjust the volume level or simply switch the sound ON/OFF as you desire.



9 settings for pH

Wide choice range of pH. Enhanced convenience with One-Touch operation



Digital Filter Life Indicator

The easy to read digital indicator gives you an approximate indication of remaining water filter life. Optimum performance is ensured by always changing your filter on time. In addition to the digital counter, a new indicator light will flicker when your current filter life is up, reminding you to change your filter.



Enhanced convenience in filter replacement

You remove the filter cover and the spring-loaded filter housing makes it a snap to replace your filter. **MAKE SURE NOT TO THROW AWAY THE FILTER CUP AT BOTTOM OF FILTER!!!**



MICOM control system

MICOM control system optimizes the pH and ORP of your water and helps keeps your ionizer in top working condition. A new indicator light alerts you if service is needed on your ionizer.



Flux control

Fully automated flux control through an advanced new patented valve system greatly enhances the optimization of pH and ORP in your water.

Safety Precautions

Do not attempt to repair the machine if you encounter a technical problem, first contact the IonWays Associate you purchased the machine from, then IonWays Technical Support if needed.

Electrical power precautions

! If your Ionizer becomes submerged in water, unplug the power cord from the wall BEFORE removing the Ionizer from the water. Failure to do so may cause electric shock!



! NEVER attempt to repair or service the unit yourself. Contact your dealer. Attempting to do so will void your valuable warranty!

! Do not use your Ionizer at voltages other than specified (AC 110V FOR USA). Use a GFI outlet. Do not plug in your Ionizer where it will exceed the rating of outlet or electric wiring. Failure to do so can result in fire, injury and/or damage to yourself, wiring or your Ionizer!



! NEVER touch the power cord or plug with wet hands – this may result in electric shock!



! Ensure the power plug is firmly and properly inserted into the outlet – failure to do so may result in electric shock or fire!



! Do not wash your Ionizer by immersion or by pouring water over the main body; always unplug your Ionizer while cleaning the casing. Clean with damp sponge or cloth.

Installation Precautions

! Protect your Ionizer from freezing temperatures.



! Protect your Ionizer from direct sunlight.



! Do not put anything heavy on top of your Ionizer. Do not install your Ionizer on an unstable or soft surface. Install only on a hard and level surface.



Maintenance Precautions

! Always unplug your Ionizer when changing the fuse or cleaning your Ionizer – failure to do so may result in electric shock.

! Do not attempt to repair or service the unit yourself. Contact your dealer. Attempting to do so will void your valuable warranty!

Common Sense Precautions

! Make sure to use your Ionizer only with potable water which is suitable for human consumption.

! DO NOT use your Ionizer with well water, water with extreme hardness, high sediment or TDS levels without first consulting your dealer.



Safety Precautions

During Use

 Do not run hot water through your ionizer.





 Do not clean by pouring water over or spraying the ionizer.



 Do not close, bend, pinch, press or otherwise obstruct output ports or hoses.





 If the appliance makes strange or unusual noises or burning smells are detected, unplug the power cord immediately and contact your dealer to arrange service.

 Unplug your ionizer if you plan not to use it for an extended period or turn off the main power switch on the back of the unit. Filter replacement may be necessary.

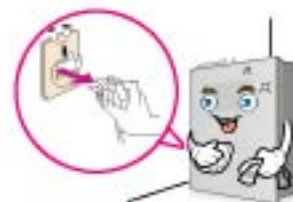

 Unplug your ionizer if you plan not to use it for an extended period or turn off the main power switch on the back of the unit. Filter replacement may be necessary.



 Acidic water is effective for washing and rinsing. In order to clean the product's internal parts and in order to drink clean water, acidic water should be run through the alkaline water tube 2 or 3 times per week and the faucet pipe should be cleaned as well.

pH Reagent Liquid Precautions

 Do not expose the pH measuring reagent to extreme heat, flames or fire. It is combustible.



 Do not drink the pH reagent liquid, put it in the eyes or apply to the body.

- If the liquid is ingested, induce vomiting immediately and call a doctor.
- If the liquid gets in the eyes, flush immediately and thoroughly with cool water; call a doctor.
- If spilled or dropped on your body, wash it off immediately.





Make sure to keep the pH reagent liquid tightly closed and out of the reach of children.

Some helpful tips

 For storing your alkaline water, glass or ceramic is best. Always try and keep your stored water cool and away from direct sunlight. You can use plastic, but only use lexan (number 7) or poly bottles (Nalgae type). It is always best fresh out of the machine and ideal if consumed on a day-to-day basis.



 Do not store alkaline water in stainless steel, bronze or aluminum containers.

 Save the box and Styrofoam your ionizer came packed in. This will help if your ionizer needs to be transported at a later date.

 Do not use an ionizer downstream of a sodium-based ion exchange softening system or Reverse Osmosis system without first consulting your dealer.

Names and functions of Parts I

Front

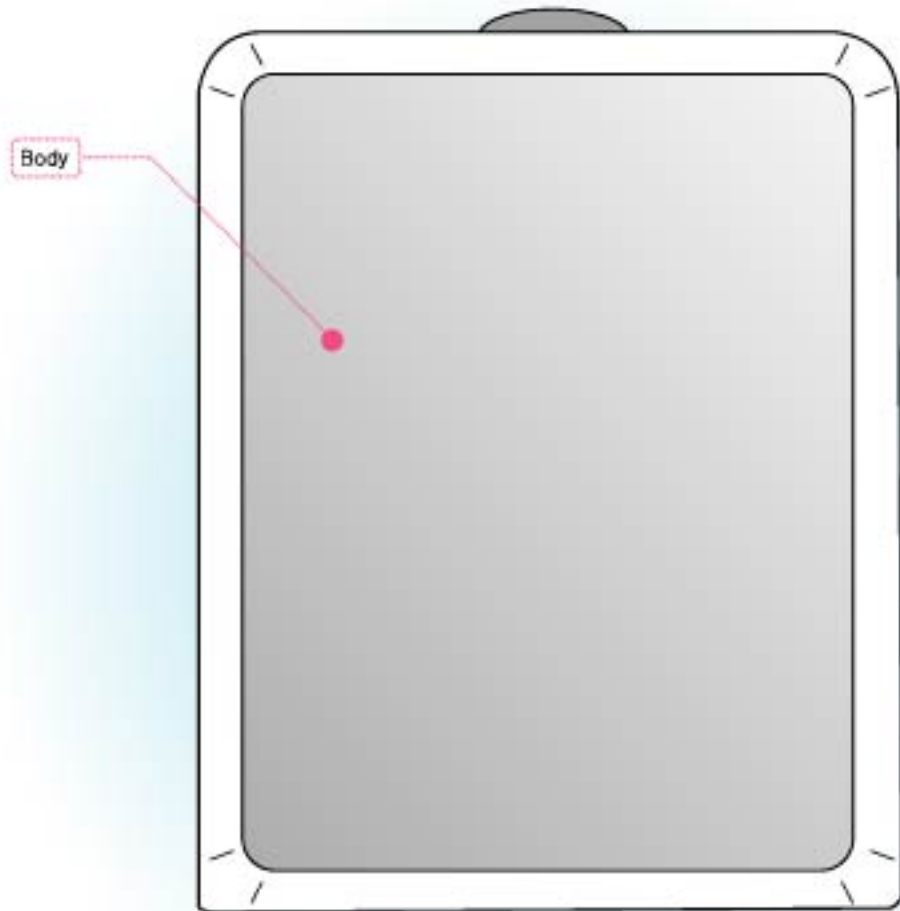

Back

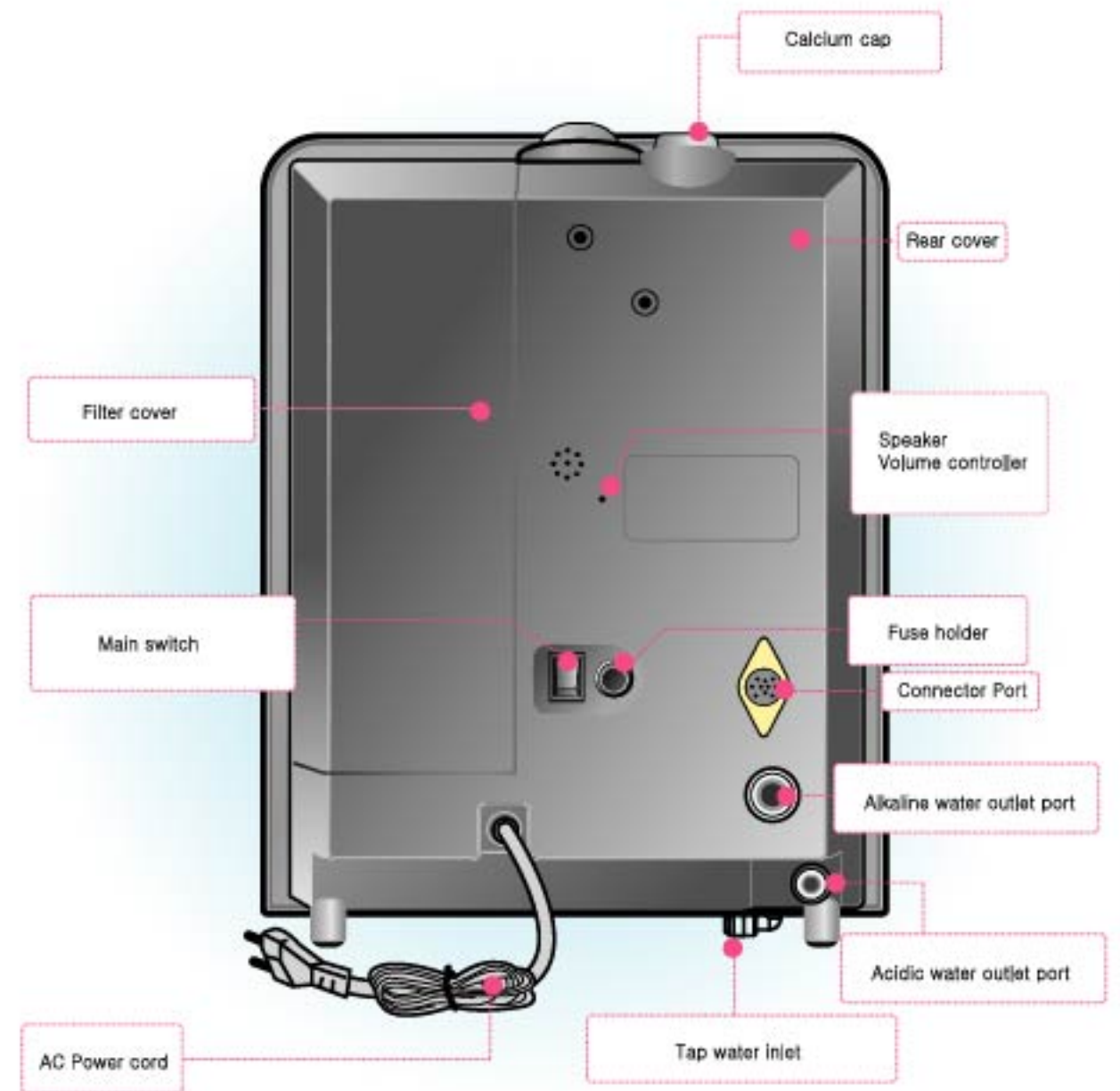

Names and functions of Parts II



Display Panel

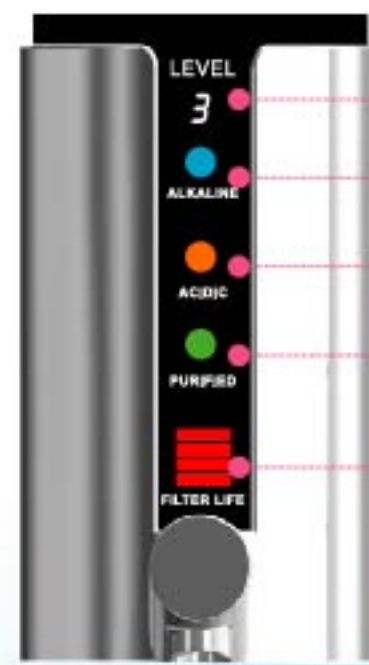

- pH level indicator**
This numeric display will indicate which level (1-4) is selected. If alkaline water is selected the number will be displayed in **BLUE**. If acidic water is selected, the number will be displayed in **ORANGE**.
- Alkaline water display indicator**
If Alkaline water is selected the **BLUE** indicator will be lit.
- Acidic water display indicator**
If Acidic water is selected the **ORANGE** indicator will be lit.
- Purified water display indicator**
If Purified water is selected the **GREEN** indicator will be lit.
- Filter life indicator**
Displays the current filter life used. When the scale reaches the top and flickers, it is time to replace your filter.



- "POWER" button**
Starts and stops water flow into your ionizer.
- "ACIDIC" water button**
Used to select acidic water and the desired level (1-4)
- "PURIFIED" water button**
Used to select purified water.
- "ALKALINE" water button**
Used to select alkaline water and the desired level (1-4)

How to Install

How To Install

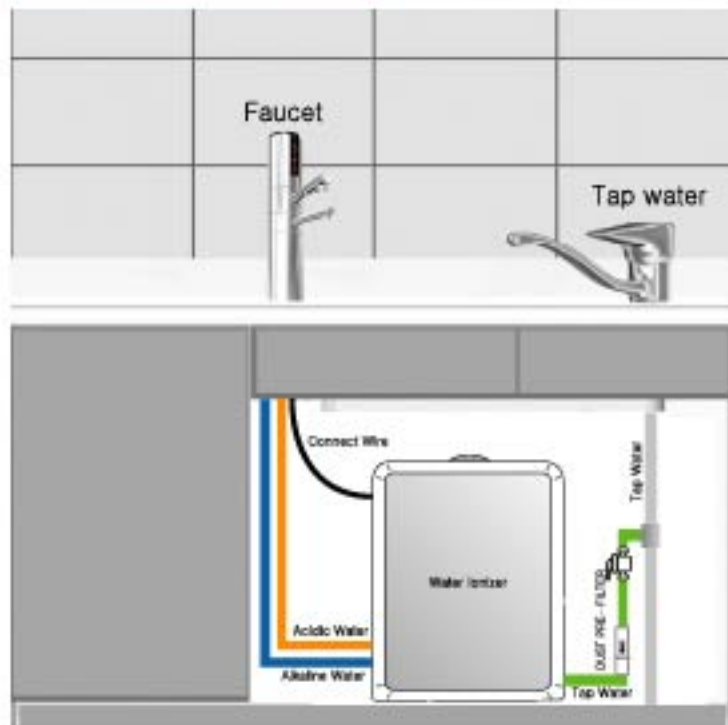

Product Requirement :
 Water pressure should be maintained at a constant rate, when the water pressure is too low, water cannot flow through the unit.

Accessories



How to connect water faucet

Connecting the Delphi faucet

All the fittings are push in style fittings. To attach the hoses to any fitting, firmly insert the end of the hose into the fitting. Pull firmly to check to connection – you should not be able to pull the hose out. To release the hose from the fitting, you must push the spring loaded ring protruding from the end of the fitting while pulling the hose out.

WARNING: incorrect installation could void your valuable warranty – professional installation is recommended.

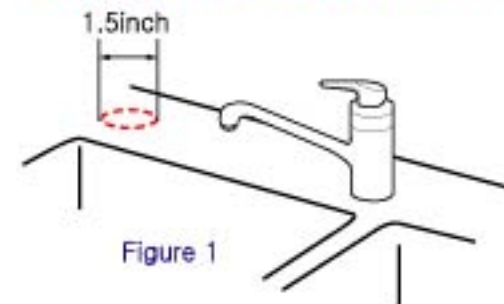

Figure 1

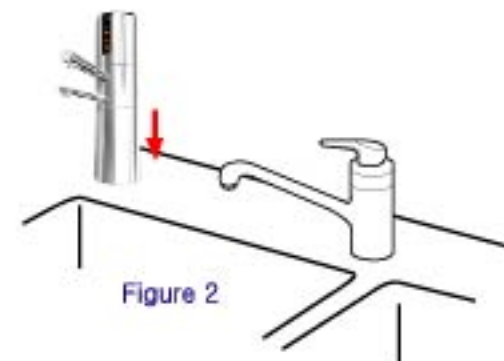

Figure 2

- 1 Use appropriate tools to make 1.5 inch diameter hole in the location where you will set up the faucet. Make sure the faucet location will allow both spouts to reach the sink.
- 2 Place the faucet in the hole properly over the gasket.
- 3 Insert the faucet in the hole and then screw it with a nut to make it be fixed.
- 4 After the faucet is fixed, connect it to fitting with 5/16" hose (for Alkaline) like figure 4. Check the hose whether it is inserted properly or not. Also, connect it with 1/4" hose (for Acidic) like figure 4 and connect the faucet to the body with connector cord.

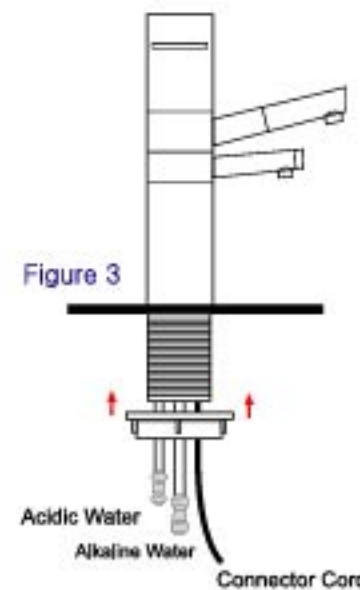

Figure 3

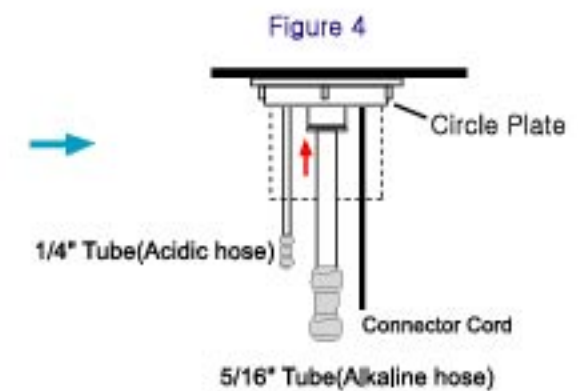
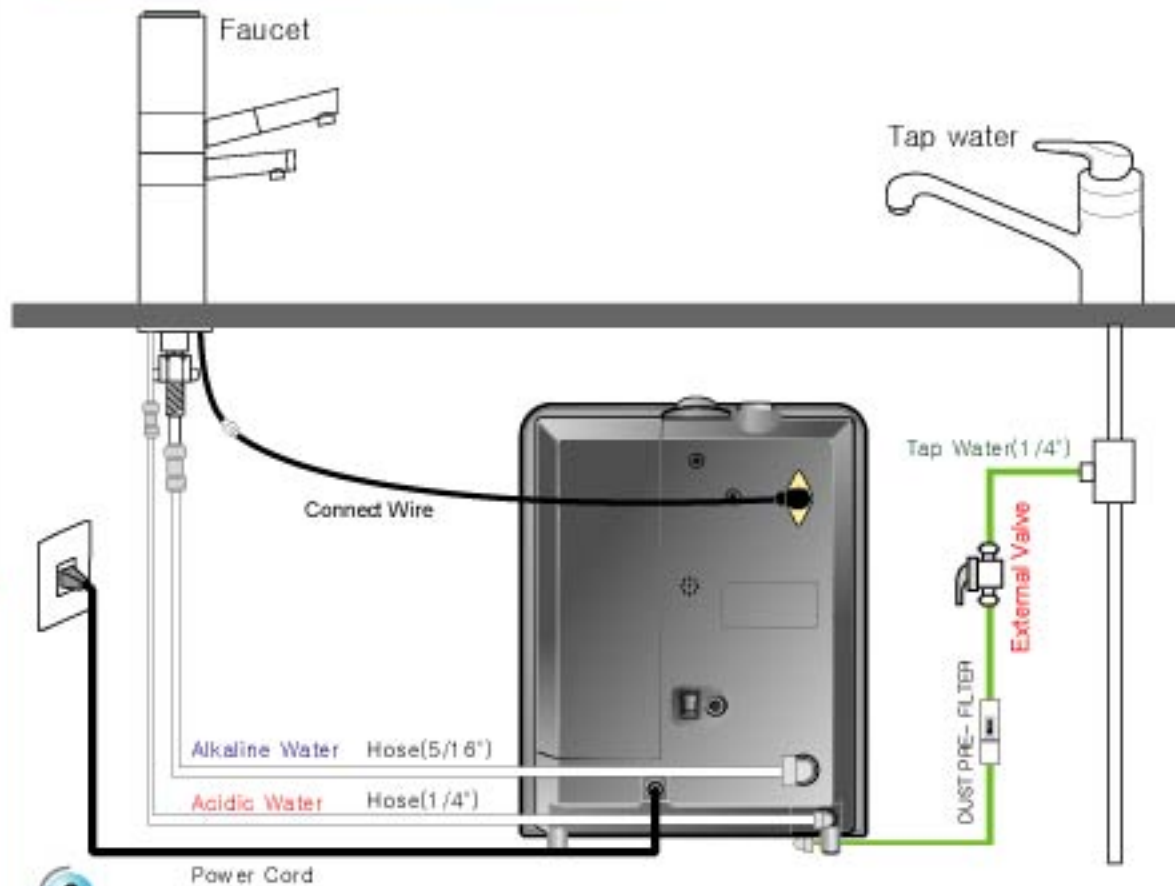

Figure 4

How to Install

Connecting the faucet and cold water hoses to the ionizer



- 6 Place the ionizer in an appropriate place under your sink.
- 7 Connect the 1/4 inch Acidic Water Hose to the small fitting on the Acidic Hose extending from the faucet to Acidic Water Outlet on the Ionizer. Pull firmly to check to connection - you should not be able to pull the hose out.
- 8 Connect 5/16 inch Alkaline Water Hose attached to the threaded stem of the faucet to the Alkaline Water Outlet on the ionizer. Pull firmly to check to connection - you should not be able to pull the hose out.
- 9 Install the dust pre-filter in the middle of a length of 1/4 inch hose with the arrow pointed at the ionizer. Connect the 1/4 inch hose with dust filter to Tap Water Inlet on the bottom of the ionizer. Pull firmly to check to connection - you should not be able to pull the hose out.
- 10 Join the wire from the faucet to the Connect Wire. Plug the Connector Cord into the Connector Port on the back of the ionizer.
- 11 Connect the power cord into an appropriate outlet.
- 12 Make sure the outlet you plug your Delphi into is live, and remember that many outlets under the sink are controlled by an on/off switch.

How to Use

How to install the external valve

- 1 Connect the external valve between the hoses.
- 2 If the water pressure is excessively high, adjust the water flow by turning the external valve.
- 3 To get the proper pH and ORP value of ionized water, set the external valve to allow 1.5 liters of water per minute to flow through the ionizer.



Initial operation

- 1 **POWER UP YOUR IONIZER.**
Turn the power button on.

Turn on
Turn off
- 2 Turn the power button to the "ON" position on the back of the ionizer.
- The power button is ALWAYS left on.
- 3 **TURN ON THE WATER**
Turn on the water by opening the water supply valve.



4 START WATER FLOW THROUGH YOUR IONIZER

- Depress the "POWER" button on the top of your Delphi faucet to start the water flow.
- NOTE: The water may initially come out discolored (light to charcoal gray) due to carbon particulates in the new filter.
- This is not harmful and is typical of all carbon filters. Allow the water to flow for 2-3 minutes in the "Purified" mode and this will flush all the carbon dust.

To select Alkaline water

- 1 With the water running through your Delphi faucet then:
- 2 Depress the "ALKALINE" button to select the desired setting from 1 - 4. The alkaline water will come out from the top spout. The display panel on the front of the faucet will show a blue Alkaline Indicator and blue number corresponding to the level selected.
- 3 Note: Your ionizer will always "remember" the last setting used. If the previous selection was Alkaline Level 2, when you start flow through the ionizer next time you use the ionizer it will automatically process at Alkaline Level 2.

How to Use

To change levels of Alkaline water

- To select a different level, depress the "ALKALINE" button to move to next level until the desired setting level is achieved. The blue number will change accordingly.

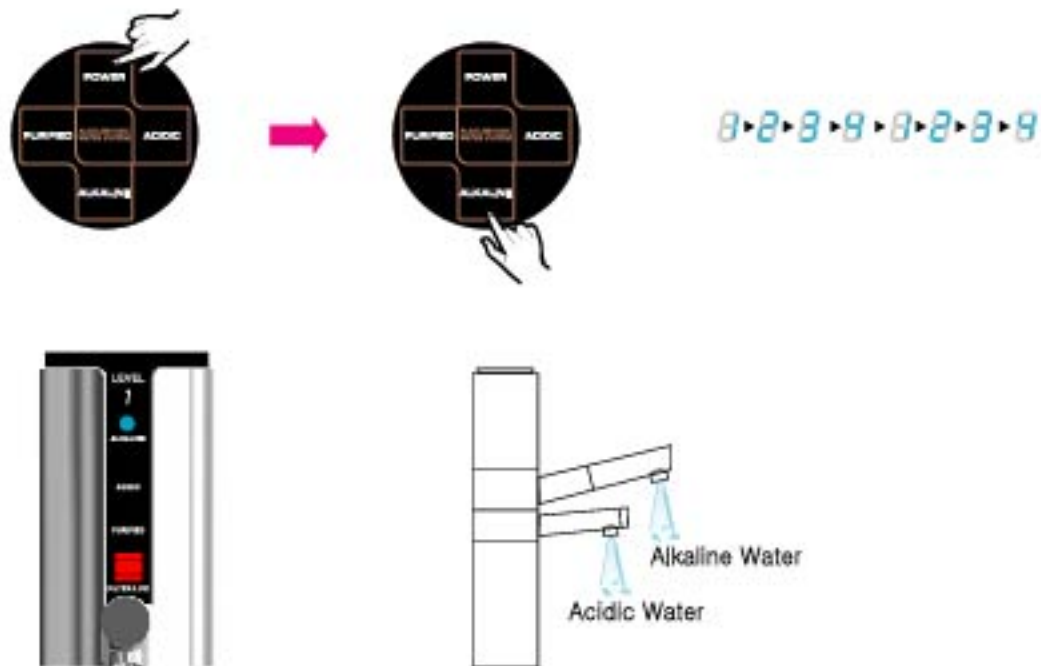

Alkaline water levels Note: pH levels will always vary with different source water.

- | | |
|---|--|
| <p>LEVEL 1
Weak Alkaline water (pH7.5 – pH8.5). This level is used for initial consumption period (4–7 days). Let your body adjust slowly to this increase in pH.</p> | <p>LEVEL 2
Weak to Medium Alkaline water (pH8 – pH9). Move up to this level after the initial adjustment period. Adjust to this level for 3–4 days. Most people will drink at level 2 or 3.</p> |
| <p>LEVEL 3
Medium to Strong Alkaline water (pH8.5 – pH9.5). This is the most common level of alkalinity for drinking purposes. Some people may start to detect a strong change in taste.</p> | <p>LEVEL 4
Strong Alkaline water (pH9.5 – pH10+). Generally, most people find this very strong tasting and with powerful detoxifying effects.</p> |

How to Use

To select Acidic water

Note: Acidic water is for external use only. DO NOT DRINK

- With the water running through your Delphi faucet then:
- Depress the "ACIDIC" button to select the desired setting. The display panel will show an orange symbol and number corresponding to the level selected. The Acidic water will come out from the top spout.
- Note: Your ionizer will always "remember" the last setting used. If the previous selection was Acidic Level 2, when you start flow through the ionizer next time you use the ionizer it will automatically process at Acidic Level 2.
- To select a different level, depress the "ACIDIC" button to move to next level until the desired setting level is achieved. The orange number will change accordingly.

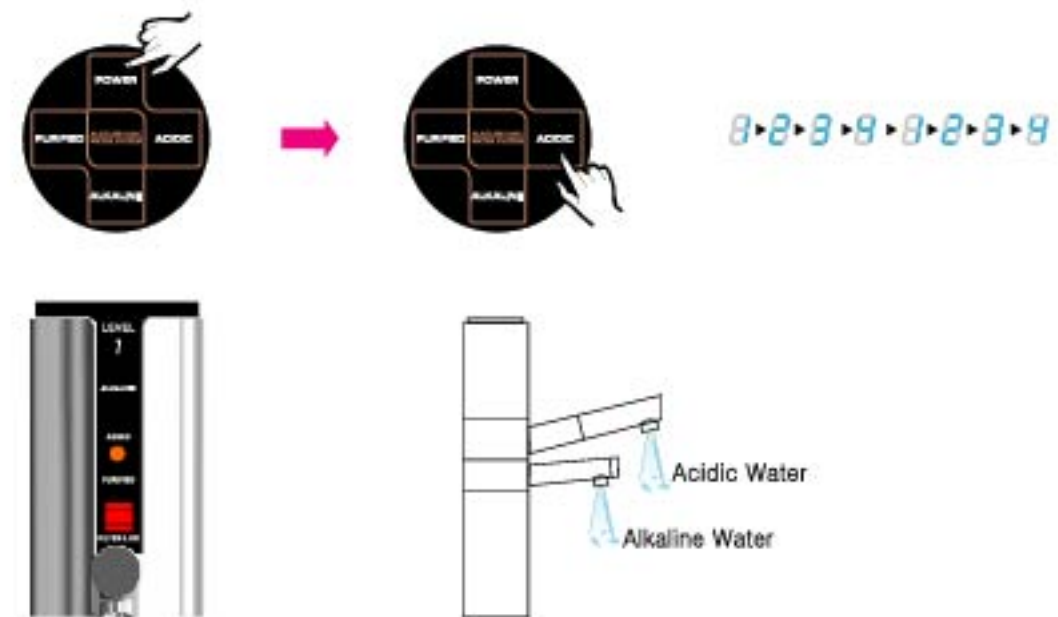

Descriptions of Acidic water levels Note: pH levels will vary with different source water.

- | | |
|---|---|
| <p>LEVEL 1
Weak Acidic water (pH6.5 – pH5.5). Used for oral hygiene, mouth wash etc.</p> | <p>LEVEL 2
Weak to Medium Acidic water (pH6 – pH5.5). For skin care, as an astringent.</p> |
| <p>LEVEL 3
Medium to Strong Acidic water (pH5.5 – pH5). For cleaning in the kitchen.</p> | <p>LEVEL 4
Strong Acidic water (pH5 and lower). For sterilization purposes.</p> |

How to Use

To select "Purified" water

- 1 With the water running through your Delphi faucet, press the 'PURIFIED' button. The display panel will show a green symbol. The purified water will come out of the top spout. Nothing comes out of the bottom outlet.

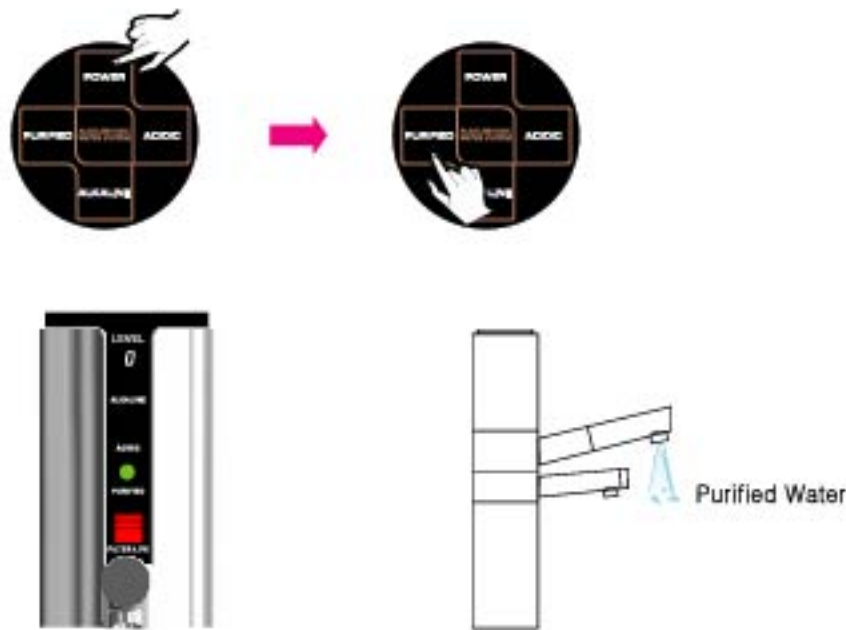

How to Shut off the water flow from your ionizer

With the water running through your Delphi faucet then depress the power button. The water will stop and the display panel will go dark indicating the ionizer is in standby or "asleep".



How to Measure pH

- 1 Fill one of the receptacles provided about 1/4 full with alkaline, acidic or purified water.

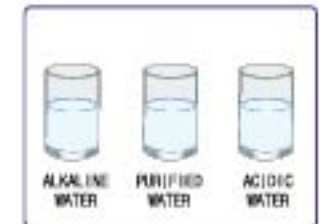

- 2 Drop 2 or 3 drops of the pH reagent into the container and shake it.
If the reagent and water are not mixed well, the correct result may not be displayed.

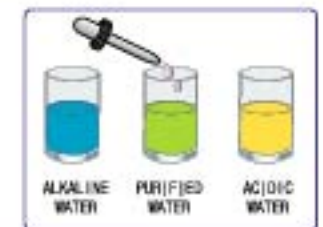

- 3 The pH value is determined by matching the color the pH color chart provided.

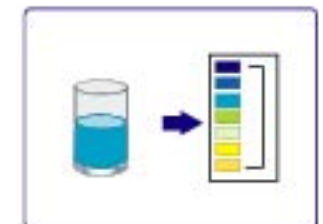

Important Note: Water quality and mineral content vary greatly in different localities and will directly impact performance of your ionizer with respect to pH.



- DO NOT consume water containing reagent
- Keep the pH reagent liquid, color chart, and test tubes away from direct sunlight
- KEEP pH reagent liquid AWAY FROM CHILDREN and OPEN FLAMES!
- For contact with eyes, flush liberally with fresh water, seek medical help
- If ingested, induce vomiting, seek medical help

How to set your individual pH levels

User can regulate the electrical current of the water ionizer based on the water source.

- 1 Depress the "PURIFIED" button for 5 seconds on the faucet.



- 2 With the beep sound, the default setting level 3 appears on the pH level indicator of the display panel. (You can select the desired setting from 0-6)



- 3 Depress the "ALKALINE" button to raise to the desired setting, and depress the "ACIDIC" button to lower to the desired setting.

0 > 1 > 2 > 3 > 4 > 5 > 6

0 < 1 < 2 < 3 < 4 < 5 < 6

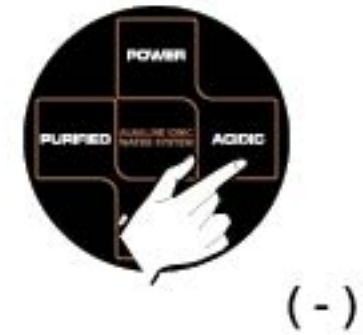
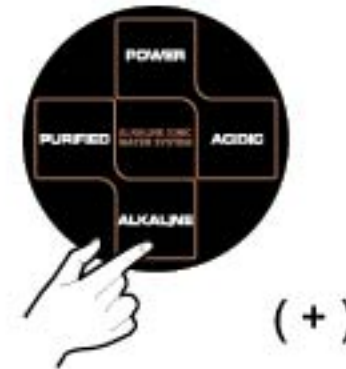

- 4 To fix the setting you selected, depress the "PURIFIED" button on the faucet.



How to Add Calcium

Adding calcium to your machine is NOT needed unless you have unusually soft water, low in minerals. If your machine is making adequate pH, there is no need to add the calcium insert.

- 1 Stop the water flow prior to calcium replacement.
 - Water will overflow if you open the calcium cap while water is coming out.

- 2 Unscrew the cap to the left and remove.
 - The first time you remove it the cap may be tight. Use a butter knife to work it free.

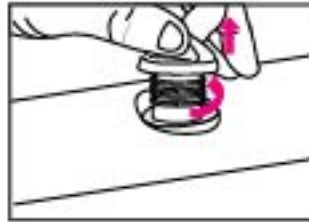
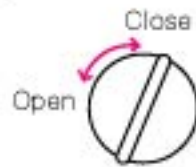

- 3 Take the basket apart from the cap and dispose of the remaining beads. The beads never completely disappear - it's the calcium coating on the beads that slowly releases into the water. Beads will release calcium for about 1-2 months depending on amount of use and pH of water.



- 4 Wash the basket and remove all water.



- 5 Add the new calcium beads and close the cap.



- 6 Insert the basket into the calcium port and twist the cap closed.
 - Water will overflow if you do not close the cap tightly.

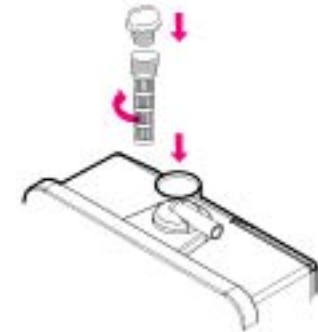

REGULARLY CHECK AND CLEAN YOUR IN-LINE PRE-FILTER

Keeping the in-line pre-filter clean is critical to the proper operation of your ionizer. First ensure your water supply is turned off.

Then remove the in-line pre-filter by pressing the spring loaded ring protruding from the end of the fitting while pulling the hose out. Rinse out the filter thoroughly to remove any built up particulate. Rinse from both sides.

Reinstall it.

Clean the filter in this way any time you notice a decreased flow from your ionizer.

To release the hose from the fitting, you must push the spring loaded ring protruding from the end of the fitting while pulling the hose out.

How to Replace the Filter

How to Replace the Filter

IMPORTANT! Stop water flow prior to filter replacement.

- 1 When the digital filter life indicator reaches full or you see the flickering filter symbol, it is time to replace your filter.



- 2 Open the filter housing cover.

– First, slide the cover upwards (figure 1) Then, slide the cover to the left (figure 2) and remove it.



- 3 Remove the expired filter.

– Taking hold of the filter securely with your right hand, press the filter firmly down against the spring loaded mechanism (figure1) to disengage the top of the filter and then pull it toward you (figure2) and up to remove it.
– The upper part of the filter is separated from housing by pressing firmly down. Once you have engaged the spring loaded mechanism, you can then easily remove the filter from the main body by pulling it toward you.
– There will be a gray filter cup at the bottom of the filter. Remove this piece from the expired filter and reinsert the cup into the base of the housing.

IMPORTANT!! There will be a gray filter cup at the bottom of the filter. Remove this piece from the expired filter and reinsert the cup into the base of the housing.



- 4 Insert the new filter into the compartment.

– Ensure the gray filter cup has been reinserted properly into the base.
– Remove the plastic caps covering both ends of the new filter.
– Seat the large opening on the bottom of the filter cartridge onto the base (with the black o-ring) in the center of the gray filter cup.
– Push the filter down and into the housing compartment ensuring the opening at the top of the filter is seated properly into the fitting at the top of the housing.



- 5 Check for leakage by running water through your ionizer before replacing the housing cover.

- 5 Flush out the GAC carbon dust.
– The water will initially come out discolored (light to charcoal gray) due to carbon particulates in the new filter. This is not harmful and is typical of all GAC filters. Allow the water to flow for 2–3 minutes in the "Purified" mode and this will flush all the carbon dust.

Immediately after filter replacement, the water will come out black and unclear due to the activated carbon particulates in the new filter but will become clear momentarily. (It is not harmful.)



- 6 Press the reset button located at the top of the filter housing compartment, and hold for up to 15 seconds while ionizer is in standby mode (water not running, power to machine on). NOTE: When filter life indicator is reset, and also when machine is new, no bars will be showing.

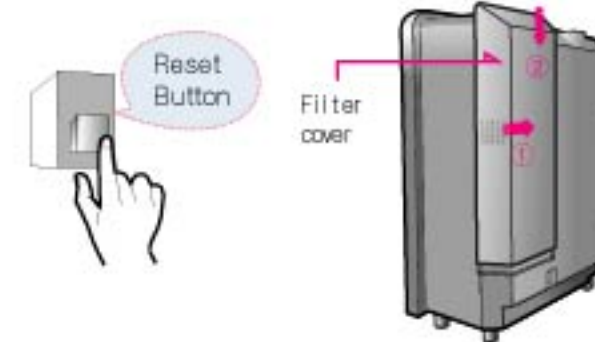

- 7 Replace the filter housing cover.



Please replace filter when any one of the flowing occur:

- When severely polluted water has been run through the ionizer and filter
- Excessive odor in output water and/or severely decreased flow rate
- After prolonged period of inactivity of over 30 days

About your revolutionary Biostone Filter

Composition of filter

Calcium:

It slightly increases the alkaline mineral content in your water. It improves water taste and odors, and it is particularly effective in removing the chloride. You get coral calcium on tap!

Tourmaline:

Tourmaline emits Far Infra Red (FIR) energy naturally. FIR produces well documented health benefits and it also has an amazing effect on water.

The Biostone contains the semi-precious gemstone tourmaline in ceramic form, so you get FIR on tap!

Non-woven fabric filter

Filters out sediment and particulate.

Granular Activated Carbon (GAC) :

The workhorse of the filtration media. GAC is especially effective at removing chlorine, its odor and taste, agricultural chemicals, phenol, trihalomethane and other chemical contaminants. Silver is coated on the surface of the granular activated carbon to inhibit bacterial growth in between use.

Non woven fabric filter :

Filters out sediment and particulate.



Flow Diagram

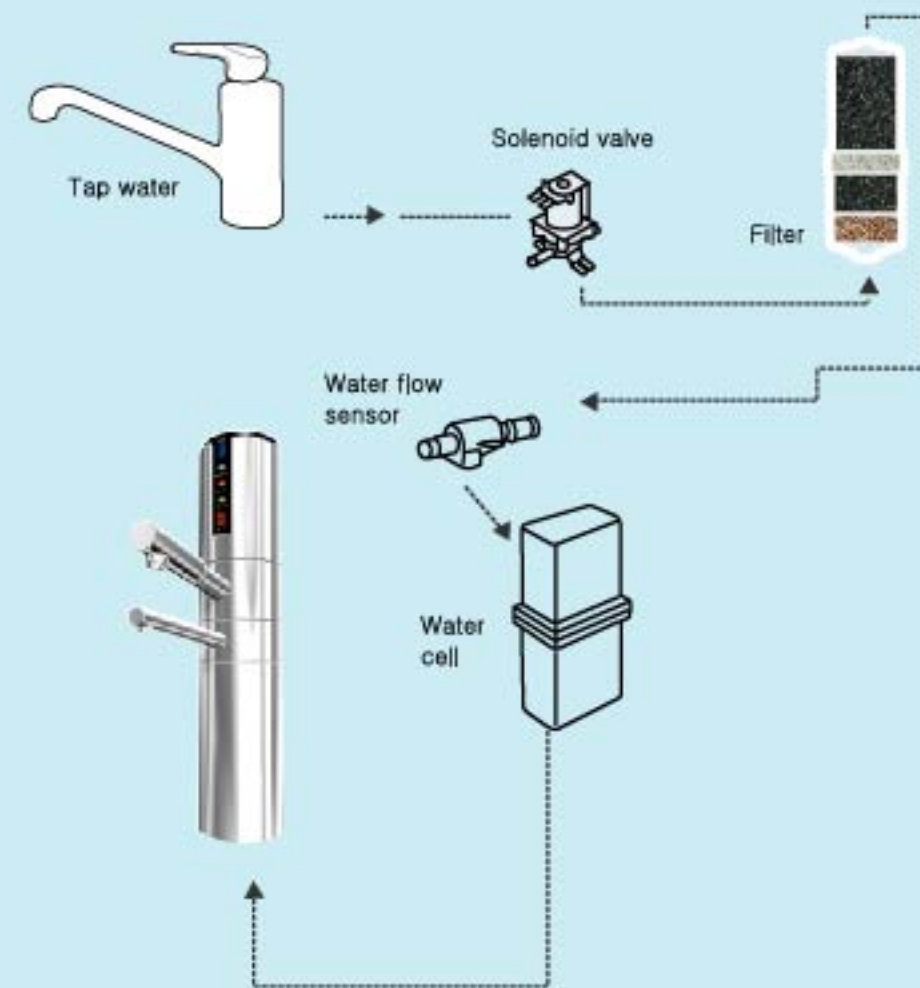

Trouble Shooting Guide

Abnormal condition	Cause(s)	Resolution
The Function Display Panel does not come on.	A power plug is not properly inserted, or it is inserted into a faulty outlet.	Properly insert power plug into a correctly functioning power outlet
	The fuse is blown. The fuse is not inserted properly.	Replace the fuse. A spare fuse is included in your reagent kit (3A / 250V fuse)
The Function Display Panel / display indicators do not come on even after turning the tap on.	Faulty PCB (Printed Circuit Board)	Immediately unplug the unit and contact your dealer to arrange service.
pH test shows alkaline water color as neutral (7) while acidic water color gets yellow (6). This is normal if initial pH is 6.5	Faulty or evaporated reagent: alkaline / acidity are always produced in inverse proportion. Therefore, showing an acidic color means inversely that alkaline water has to be generated from the unit. Lack of alkaline color can result from a chemical reaction where carbonic acid in water evaporates some test reagent elements.	Test pH value on level 3 or 4 water; replace reagent.
Power supply is suddenly cut off while operating the unit.	Elevated level of salt in the water or high TDS: extended operation at high pH: sudden flux in electrical current. In these cases your machine will shut down automatically to protect the electrodes and circuitry.	Wait – the unit will become operational again after about one hour. Your ionizer has a safety mechanism built-in to protect the electrodes and circuitry. This mechanism will shut the ionizer down automatically. This mechanism protects the unit from overuse or excessive electric current.
Low output of alkaline water from the unit.	Filter is clogged. Premature clogging may be caused by sudden drop in water quality and an influx of sediment or other contaminants, which stress the filter.	Replace your filter. Clean Pre-filter
	Low pressure in your household plumbing.	Ensure water supply valves are fully open. The water pressure in house may be too low.
	The input hose is bent, kinked or otherwise restricted.	Straighten the bent hose.
Poor / Irregular pH Production at levels 1,2,3 and 4	Either overly hard or soft water (excess or lack of minerals in water)	Adjust the voltage output, please refer to page 23 in this manual

Abnormal condition	Cause(s)	Resolution
Strange smell from Alkaline water.	Expired filter from ordinary use or premature clogging due to flux in water quality.	Replace your filter.
	Sudden flux in water quality with elevated level of Choline (not Chlorine). Elevated Choline levels are observed in some areas during summer months. These levels fall within safe drinking water standards, yet will cause a reaction with ionized water causing a unique smell.	Select lower pH level (1-2). If still present, filter replacement may be necessary.
Water appears milky: white snow like particles in the bottom of your glass.	You have high hardness (calcium primarily) in your water. The white is extracted CaCO ₃ (Calcium carbonate). After CO ₂ in water is bonded with Ca where elevated levels of CO ₃ exist in your water. In water where elevated levels of CO ₃ exist, what you see after ionization is CO ₂ in the water bonded with Ca.	This is calcium! It is not only harmless, but actually good for you. Remember the ionizer separates and condenses the alkaline minerals and this is what you are seeing. You can lower the setting (1-2) and reduce this effect. Typically this only occurs in hard water areas.
At first no smell, but then smell from the alkaline water about one hour after.	Your water bottle or receptacle is foul and needs cleaning. Contamination mixes with alkaline water when filling your bottle. Expired filter.	Clean your bottle or receptacle. Try selecting lower pH level (1-2). Replace your filter.
Water leakage from the filter cartridge housing.	Filter not installed correctly into filter housing.	Remove your filter and reinstall it properly following the filter replacement instructions. Increase the quantity of source water inflow.
No acid water flow from the acidic output port.	Acidic output hose is bent, kinked or otherwise restricted.	Straighten the bent hose; increase water flow from supply.

Product Specifications		
Product Manufacture Permission Number	No.610 by The Ministry of Health & Welfare	
Feature	Ion water generator	
Model	Delphi	
Input voltage	AC120V / 220V / 240V	
Input Electricity(Power consumption)	0.38A(80W)	
Weight	Approx 6.5kg	
Overall Dimention	245 X 130X 330(mm)	
Applicable Water Inflow Pressure	0.7~5kg/cm ²	
Applicable Water Temperature	5~30 °C	
Unit Operation Type	One Touch - Automatical ionization Start	
Unit Operation Means	Tap - water - open and - close	
Electrolysis Device	Electrolysis Method	Continuous electrolysis
	Electrolysis Strength	4 level
	Ionized Water Output Rate	Max 3 Liters/minute(alkaline+acidic water)
	Cleaning Device	Automatic & manual cleaning
	Electrode Materials	Platium and Titanium
Water Purifying Device	Filter Replacement	Easy replaceable cartridge
	Filter Life	Activated Carbon filter:approx 5~6 months basic 20 Liter/day
	Filter Life Indicator	FND indicator
	Filter Composition	Silver impregnated Carbon
Water Purifying Device	Temperature sensor / Auto Shut off	
Water Supply	Direct connection to a top	

How to assemble the spouts

When you first open the faucet box you will find an allen wrench and the spouts for your faucet. You need to install the spouts to the faucet. There are allen screws in the faucet where the spouts attach. Use the allen wrench to loosen those screws a little to install the spouts. Once you loosen the screws, slide the longer of the two spouts into the top hole and tighten the allen screw. Be Careful not to over tighten screws and make sure that the spout is flush with the faucet. Next do the same with the lower or shorter spout. Once this procedure is done and the faucet is installed check the spouts for leaks.

