

# ***Portable Room Air Conditioner***

Models: WPAC8000  
WPAC10000

**DO NOT RETURN THIS PRODUCT TO THE STORE**  
If you have questions or need assistance, please call customer  
service at 855-944-3571.

# INTRODUCTION

## TABLE OF CONTENTS

### INTRODUCTION

DISCLAIMERS .....2  
ALL RIGHTS RESERVED.....2

### SAFETY

SAFETY DEFINITIONS.....4  
SAFETY INSTRUCTIONS .....4  
OPERATION ENVIRONMENT .....5  
REFRIGERANT.....5

### INSTALLATION

UNIT OVERVIEW.....6  
SELECTION OF INSTALLATION LOCATION.....7  
INCLUDED PARTS .....7  
INSTALL CORD HOOKS .....8  
SELECT LOCATION .....8  
INSTALL EXHAUST DUCT .....8  
INSTALL THE WINDOW VENT KIT .....9  
CONNECT CONTINUOUS DRAIN (OPTIONAL).....11  
INSTALL BATTERIES IN REMOTE .....12  
TEST OPERATION .....12

### OPERATION

CONTROL PANEL .....13  
REMOTE CONTROL .....14  
OPERATE THE UNIT .....15

## INTRODUCTION

### DISCLAIMERS

All information, illustrations, and specifications in this manual were in effect at the time of publishing. The illustrations used in this manual are intended as representative reference views only. We reserve the right to make any specification or design change without notice.

Manufacturer will bear no responsibility when personal injury or property loss is caused by the following:

- Damage due to improper use or misuse of the product.
- Product is altered, maintained, or used in a manner contrary to instructions in this manual
- After verification, the defect is directly caused by corrosive gas.
- After verification, the defects are due to improper operation during transportation of product;
- Operate, repair, or maintain the unit contrary to instruction manual or related regulations.
- After verification, the problem or dispute is caused by the quality specification or performance of parts and components that produced by other manufacturers;
- Damage is caused by natural calamities, bad use environment or force majeure.

### CARE AND MAINTENANCE

CLEAN OUTER CASE AND GRILLE.....16  
CLEANING THE FILTER.....16  
CLEAN EXHAUST DUCT .....16  
EMPTY WATER FROM CHASSIS.....16  
CHECKING BEFORE USE-SEASON.....16  
CHECKING AFTER USE-SEASON .....17  
LONG-TERM STORAGE .....17  
NOTICE FOR RECOVERY .....17

### TROUBLESHOOTING

TROUBLESHOOTING .....18  
ERROR CODES .....19

### WARRANTY CLAIMS

WHAT'S COVERED?.....20  
WARRANTY PERIOD .....20  
WHAT'S NOT COVERED? .....20  
WHO'S COVERED? .....20  
WHAT WILL TOSOT DIRECT DO?.....20  
OPEN BOX ITEMS .....21  
RETURN PRODUCTS YOU ARE UNSATISFIED WITH .....21  
RETURN DEFECTIVE ITEMS .....21  
WHEN WILL A REPLACEMENT BE SENT?.....21  
HOW LONG DOES IT TAKE FOR ME TO GET A REFUND..21

### ALL RIGHTS RESERVED

All rights reserved. No reproduction allowed in any form without written permission from Westinghouse Outdoor Power Equipment.

<b>▲ DANGER</b>	
	Read this manual before using or performing maintenance on this product. Failure to follow the instructions and safety precautions in this manual can result in serious injury or death.

## SAVE THESE INSTRUCTIONS

# INTRODUCTION

## UPDATES

The latest User Manual for your Westinghouse generator can be found under our support tab. <https://westinghouseoutdoorpower.com/pages/manuals>

Or scan the following QR code with your smartphone camera to be directed to the link.



**IMPORTANT:** Keep your purchase receipt for trouble-free warranty coverage.

## NOTICE

Thank you for choosing Westinghouse!

PLEASE READ BEFORE RETURNING THIS PRODUCT FOR ANY REASON.

If you have a question or experience a problem with your Westinghouse purchase, call us at 855-944-3571 to speak with an agent.

SAVE THIS MANUAL FOR FUTURE REFERENCE.

## PRODUCT REGISTRATION

For trouble-free warranty coverage, it is important to register your Westinghouse generator.

You can register by:

- Completing and mailing the product registration card included in the carton.
- Registering your product on-line at: <https://westinghouseoutdoorpower.com/pages/warranty-registration>
- Scan the following QR code with your smartphone camera to be directed to the mobile registration link.



- Sending the following product information to:

Westinghouse Outdoor Power  
Warranty registration  
777 Manor Park Drive  
Columbus, OH 43228

## For Your Records

Date of Purchase: \_\_\_\_\_

Model Number: \_\_\_\_\_

Serial Number: \_\_\_\_\_

Place of Purchase: \_\_\_\_\_

# SAFETY

## SAFETY

### SAFETY DEFINITIONS

The words DANGER, WARNING, CAUTION, and NOTICE are used throughout this manual to highlight important information. Make sure that the meanings of this safety information is known to all who operate, perform maintenance on, or are near the unit.



**This safety alert symbol appears with most safety statements. It means attention, be alert, your safety is involved! Please read and abide by the message that follows the safety alerts symbol.**

#### ▲ DANGER

Indicates a hazardous situation which, if not avoided, will result in death or serious injury.

#### ▲ WARNING

Indicates a hazardous situation which, if not avoided, could result in death or serious injury.

#### ▲ CAUTION

Indicates a hazardous situation which, if not avoided, could result in minor or moderate injury.

#### NOTICE

Indicates a situation which can cause damage to the unit, personal property, and/or the environment, or cause the equipment to operate improperly.

**Note:** Indicates a procedure, practice or condition that should be followed for the unit to function in the manner intended.

## SAFETY INSTRUCTIONS

### ▲ WARNING

To reduce the risk of injury, the user must read and understand the instructions before using this product.

### ▲ WARNING

When using this product, basic precautions should always be followed, including the following:

- Before operation, confirm that power specification complies with that on nameplate.
- Before cleaning or maintaining the air conditioner, turn off air conditioner and pull out the power plug.
- Ensure that the power cord is undamaged. Do not pull or drag the power cord to pull out the power plug or move the air conditioner.
- Do not insert or pull out the power plug with wet hands.
- Use the grounded power. Make sure the grounding is reliable. If the supply cord is damaged, it must be replaced by the manufacturer or its service agent or a similarly qualified person in order to avoid a hazard.
- If abnormal condition occurs (e.g. burned smell), disconnect power at once and contact local dealer. When nobody is taking care of the unit, turn it off and remove the power plug or disconnect power.
- Do not splash or pour water on air conditioner. This may cause a short circuit or other damage to air conditioner.
- If drainage hose is used, ambient temperature can't be lower than 0° C. Otherwise, it will cause water leakage to air conditioner.
- Do not operate heating equipment around the air conditioner.
- Do not operate the unit in the bathroom or laundry room.
- Keep far away from fire source, flammable and explosive objects.
- Keep children from playing or climbing on the air conditioner. Do not put or hang dripping objects above the air conditioner. Do not repair or disassemble the air conditioner by yourself.
- Do not insert any objects into the air conditioner.
- Do not insert anything into the air duct. If anything gets in to the air duct, have the unit professionally serviced.
- Do not use an extension cord.
- Maintenance shall be conducted by an authorized service center. Otherwise, it may cause serious damage or personal injury or death.
- If refrigerant leaks or requires discharge during installation, maintenance, or disassembly, the unit

should be serviced by an authorized service center in compliance with local laws and regulations.

- Children should be supervised to ensure that they do not play with the appliance.

## OPERATION ENVIRONMENT

- During operation, close doors and windows to improve cooling. Place the air conditioner on a smooth, flat surface to minimize noise and vibration.
- This air conditioner is equipped with casters, which will slide easily on a smooth, flat surface.
- Do not operate the air conditioner on an incline or in any position other than upright. If the unit tips over, disconnect power immediately and contact dealer.
- Do not operate in direct sunshine.

## REFRIGERANT

### ▲ WARNING

**This unit uses a non-explosive flammable refrigerant gas, R32, which can be ignited by fire.**

The refrigerant used in this unit is the fluoride R32, which is specially cleaned. The refrigerant is considered mildly flammable and has no odor.

Compared to common refrigerants, R32 is a nonpolluting refrigerant with no harm to the ozoneosphere. The influence upon the greenhouse effect is also lower. R32 has very good thermodynamic features and high energy efficiency. The units therefore need less filling.

### ▲ WARNING

- Appliance filled with flammable gas R32
- Appliance shall be installed, operated and stored in a room with a floor area larger than 40 square feet (4 square meters).
- The appliance shall be stored in a room without continuously operating ignition sources (for example: open flames, an operating gas appliance, or an operating electric heater.)
- The appliance shall be stored in a well-ventilated area where the room size corresponds to the room area as specified for operation.
- The appliance shall be stored so as to prevent mechanical damage from occurring.
- Ducts connected to an appliance shall not contain an ignition source.
- Keep any required ventilation openings clear of obstruction.
- Do not pierce or burn.
- Be aware that refrigerants may not contain an odor.
- Do not use means to accelerate the defrosting process or to clean, other than those recommended by the manufacturer.
- Servicing shall be performed only as recommended by the manufacturer.
- Should repair be necessary, contact your nearest authorized Service Center. Any repairs carried out by unqualified personnel may be dangerous.
- Compliance with national gas regulations shall be observed.
- Read service manual.

# INSTALLATION

## INSTALLATION

### UNIT OVERVIEW

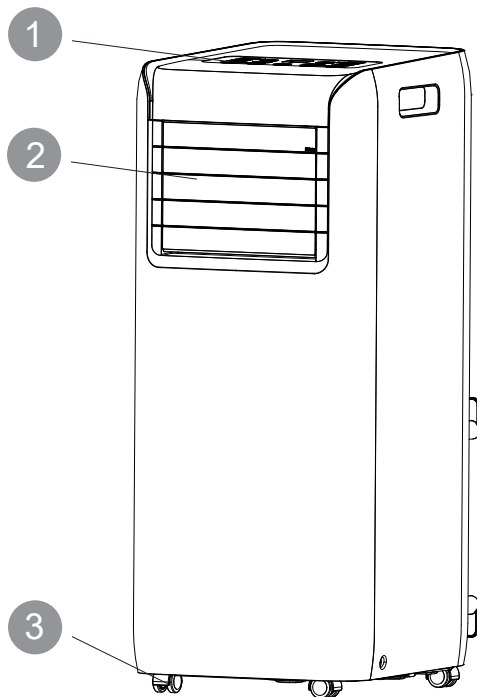

- 1 Control panel
- 2 Louver vent
- 3 Caster
- 4 Filter
- 5 Exhaust connector
- 6 Exhaust duct
- 7 Window clip
- 8 Power cord
- 9 Cord hook

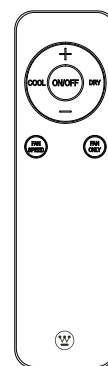
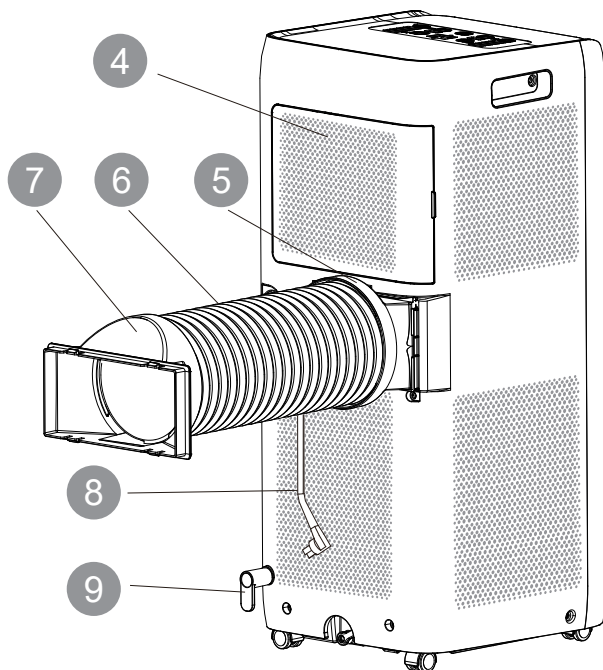

Remote control

# INSTALLATION

## SELECTION OF INSTALLATION LOCATION

### ▲ WARNING

Observe all governing codes and ordinances.  
 Do not use damaged or non-standard power cord.  
 Be cautious during installation and maintenance.  
 Prohibit incorrect operation to prevent electric shock, casualty and other accidents.

### BASIC REQUIREMENTS

Installing the unit in the following locations may cause malfunction. If it is unavoidable, please consult the local dealer:

- Near high heat sources, vapors, flammable or explosive gases, or volatile objects.
- Near high-frequency devices (such as a welding machine or medical equipment).
- On an unstable or moving structure (such as a truck) or in a corrosive environment (such as chemical factory).



### AIR CONDITIONER REQUIREMENTS

- Air inlet and exhaust should be unobstructed for optimum performance.
- Select a location where the noise and exhaust air will not affect the surroundings.
- Locate as far away as possible from fluorescent lighting.
- Do not install in laundry area.

### POWER REQUIREMENTS

- Follow all electrical safety regulations when installing the unit.
- Use a qualified power supply circuit per local regulations.
- If the supply cord is damaged, it must be replaced by the manufacturer, its service agent or similarly qualified persons in order to avoid a hazard.
- Unplug the unit before proceeding with any work related to electricity and safety.
- Do not plug the unit in before finishing installation.
- For safe operation, the air conditioner must be properly grounded. Do not modify the grounding plug; otherwise it may cause electric shock.
- The grounding resistance should comply with national electric safety regulations.

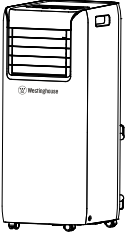
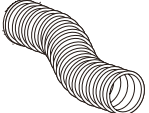
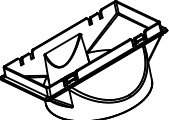
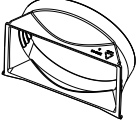
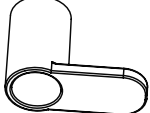
## INCLUDED PARTS

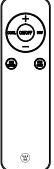
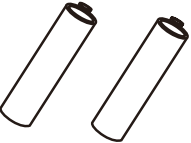
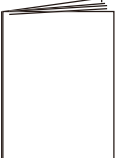
Air Conditioner	
Window Vent Kit Part no: 600005064431	See Page 9 for included parts
Exhaust duct Part no: W05236074	
Window clip Part no: 200246000004	
Exhaust connector Part no: 200109060020	
Cord hook (2) Part No: 7101600508	
Screws Phillips Pan Head Machine Screw ST4.2x16	
Remote control Part No: 305001060146	
Remote batteries, AAA 1.5V (2)	
Manual Part No: 66139902592	

# INSTALLATION

## INSTALL CORD HOOKS

Install the cord hooks at the back of the unit with 2 screws. The top cord hooks should face upward, and the bottom cord hooks should face downward.

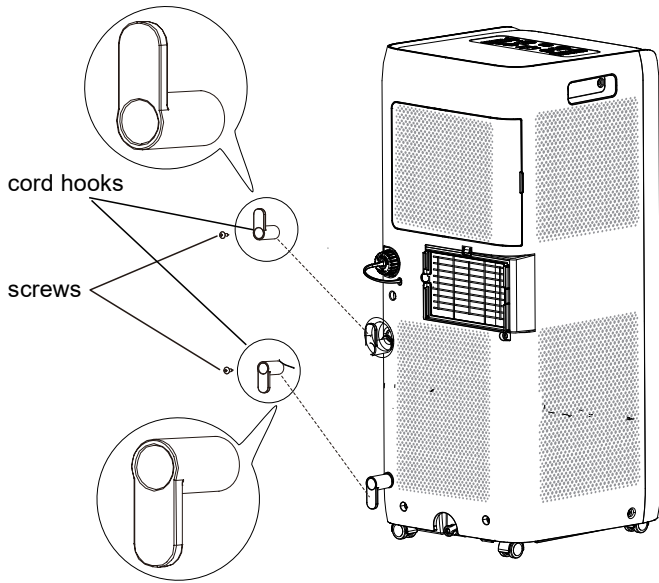

## SELECT LOCATION

Use the following guidelines to select a location for the unit:

- The air conditioner must be operated within the temperature range 61°F(16°C)-95°F(35°C).
- The appliance is for indoor use only.
- The appliance must be positioned so that the plug is accessible.
- This air conditioner is intended for home use only.
- Do not operate the air conditioner in a humid environment.
- Keep air inlet and air outlet clean and free of obstacles.
- Reserved space around the air conditioner: 30cm (12 inches)

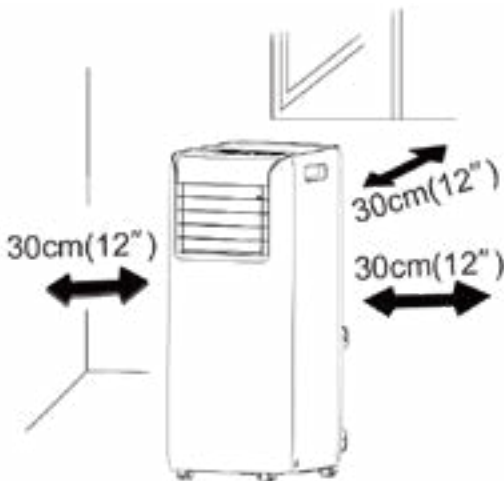

## INSTALL EXHAUST DUCT

When installing, the exhaust duct should be as flat as possible. Do not extend the duct or connect it with another exhaust duct.

The length of the exhaust duct is less than 40 inches. Keep the length as short as possible.

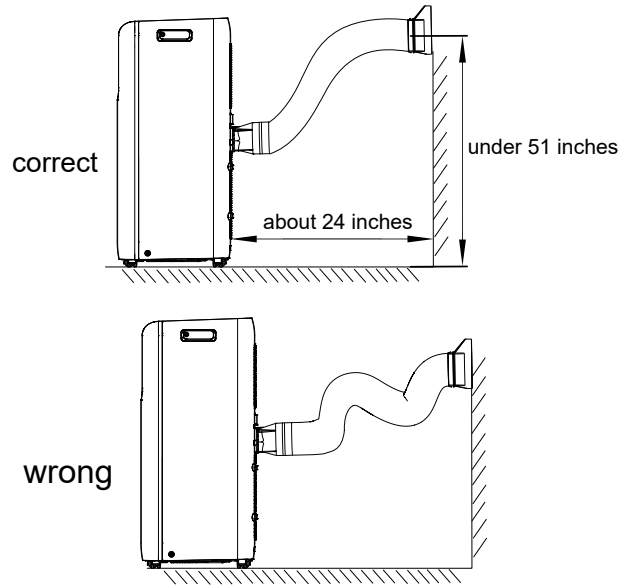

1. Rotate exhaust connector and window clip clockwise into the two ends of exhaust duct.

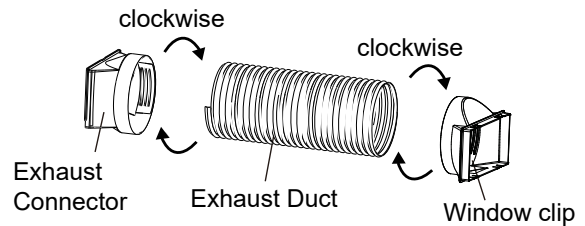

2. Insert exhaust connector into the groove of the exhaust vent on the back of the unit until it clicks into place.

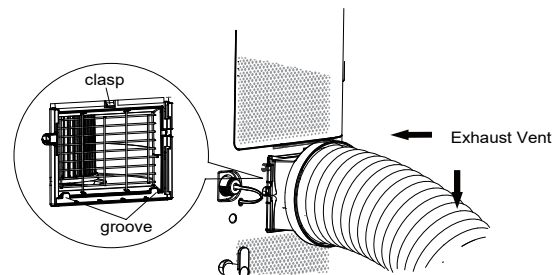



# INSTALLATION

3. Run the exhaust duct outdoors.

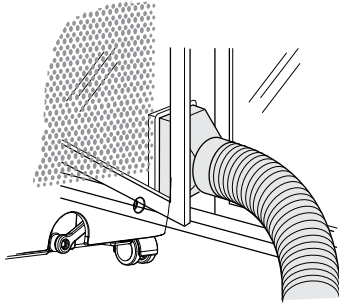

4. If using a window vent, install it following the instructions below.

## INSTALL THE WINDOW VENT KIT

Part no: 600005064431

### INCLUDED PARTS

Adjustment panel	
Window panel	
Exhaust cover	
Extension panel	
Screen	
Rain guard	
Fixed base	
Fixed clip	
Mounting plate	
Bracket (1)	
Screw (1)	
Foam seal A	
Foam seal B (adhesive type)	

### SUGGESTED TOOLS

- Screwdriver (medium size Phillips)
- Tape measure or ruler
- Knife or scissors
- Saw (In the event that the window panel needs to be cut down in size because the window is too narrow for direct installation.)

### INSTALL WINDOW PANEL

1. Open the window and measure the width or height inside the window frame. Cut the foam seal B to the proper length and attach it to your horizontal (or vertical) sliding window.

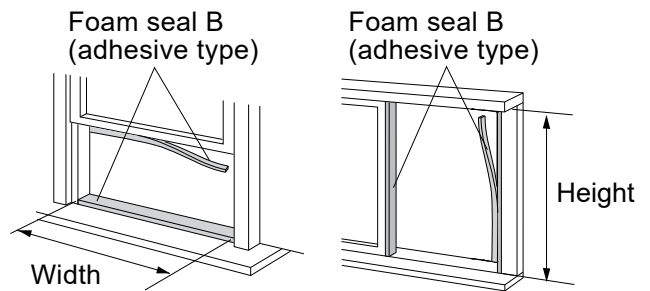

2. Attach the screen to the back side of the window panel. Push the screen securely into the window panel to ensure that it is firmly installed.

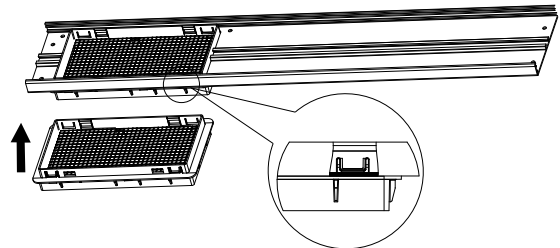

3. Insert the exhaust cover to the window panel.

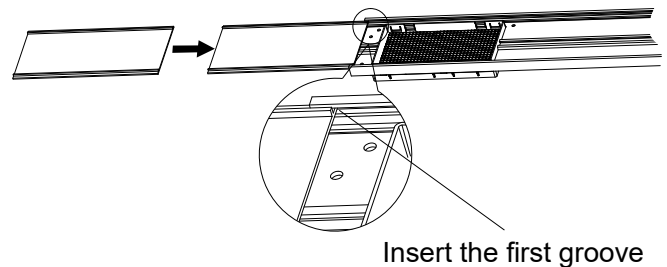

# INSTALLATION

4. Push the fixed base to the end of window panel.

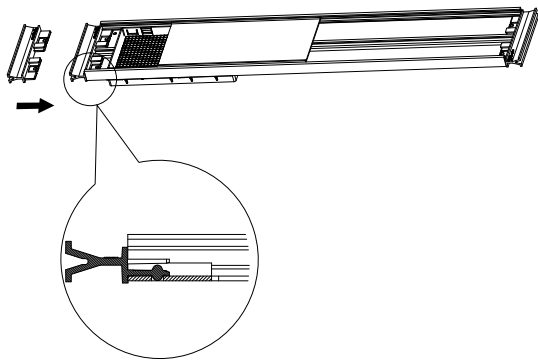

5. Connect the rain guards to the Screen. Insert all three projections on each rain guard into the holes in the Screen. Side "A" will now be at the top, as indicated in the diagram.

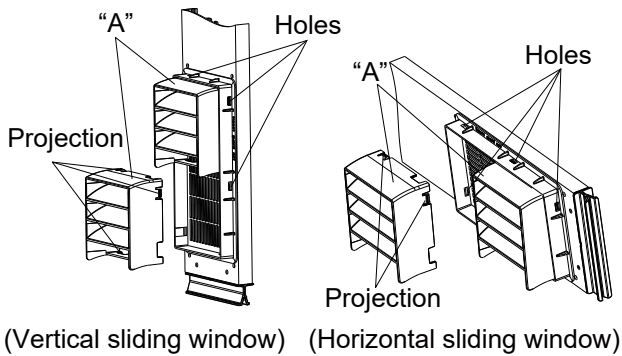

6. The window panel adapts to different window sizes that open horizontally or vertically.

- a. For the window is too narrow for direct installation, the window panel needs to be cut down in size.
- b. If the width of window is larger than the length of window panel, please use the adjustment panel to make sure you can span the entire length of your window. Otherwise, you can add an extension panel to prolong the length of the windows panel assembly.

7. Push fixed base to the end of the window panel assembly.

8. After the length is set, secure the panels with a fixed clip and mounting plate. For certain windows, such as a casement window, you will need to improvise several steps of the installation.

**Note:** Insert the fixed clip into the groove of the adjustment panel and screw down the mounting plates.

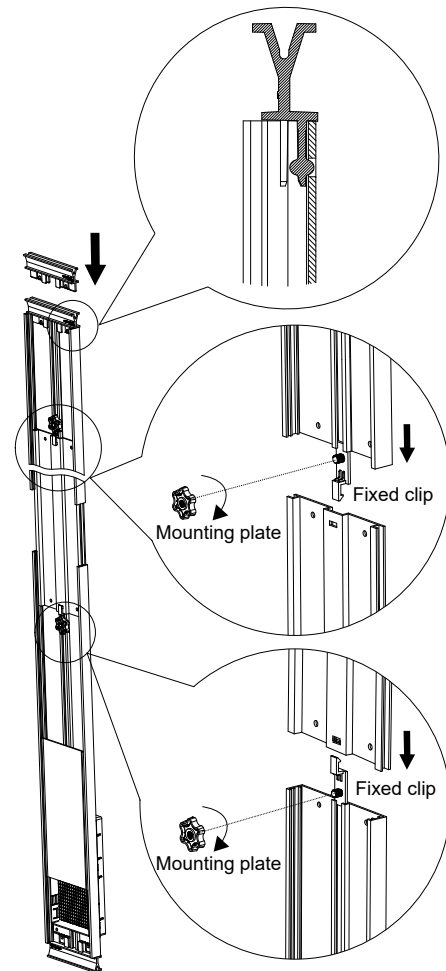

9. Install the window panel into the window frame. Make sure that the exhaust cover is attached to the window panel.

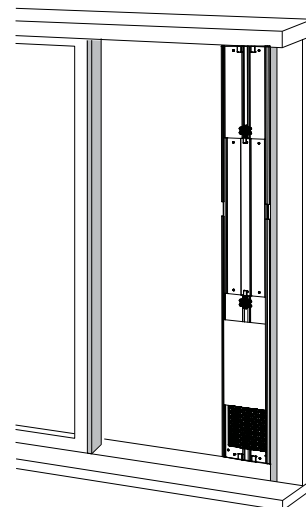

10. Close the window sash securely against the window panel.

# INSTALLATION

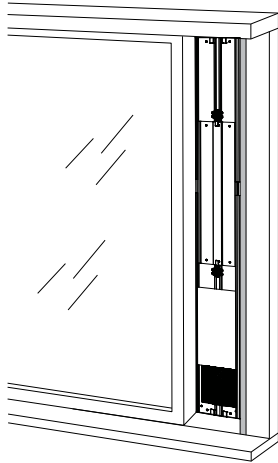

11. Stuff the foam seal A between the glass and the window to prevent air and insects from getting into the room.

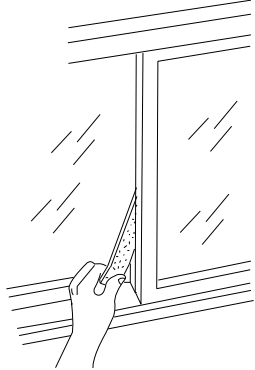

12. Attach the bracket with a screw. (Recommended)

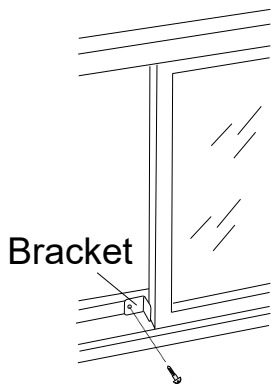

13. Slide and open the exhaust cover on the window panel, and attach the window clip/exhaust duct.

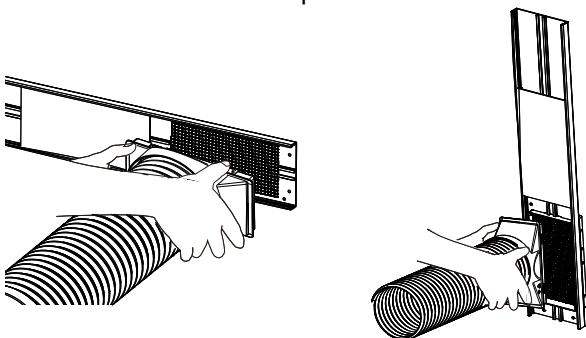

## CONNECT CONTINUOUS DRAIN (OPTIONAL)

**Note:** If not using the continuous drain option, the unit must be emptied periodically. See Care and Maintenance for instructions.

### NOTICE

When using the continuous drainage option, place unit on a level surface and make sure the hose is clear of any obstructions and directed downward. Placing unit on an uneven surface or improper hose installation may result in water filling up the chassis and causing the unit to shut off. Empty water in the chassis if shut off occurs, then check unit location and hose for proper setup.

Water can be automatically emptied into a floor drain by attaching a 13.5mm (0.53") inner diameter hose or garden hose (not included). If using the continuous drain option, use the following steps to install:

1. Remove the continuous drain cap by turning it counterclockwise, then remove the rubber plug from the spout.

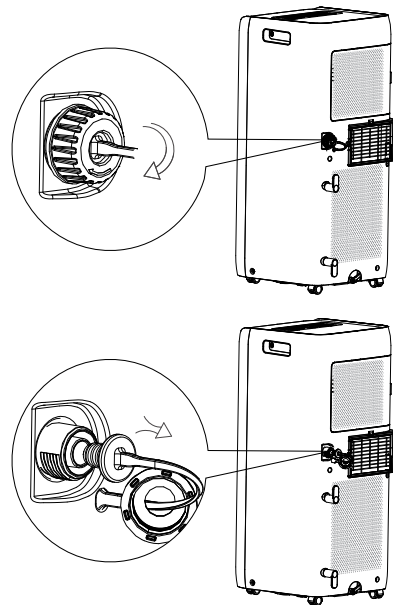

2. Insert the drainage hose into drain connector.

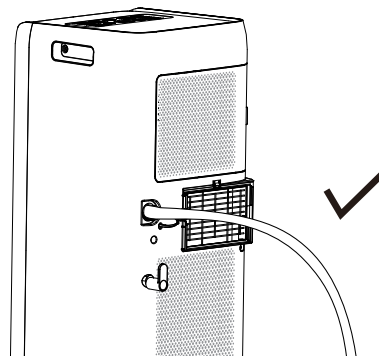

# INSTALLATION

---

3. Route drainage hose to drain.

## INSTALL BATTERIES IN REMOTE

1. Press the back side of remote control and then push out the cover of battery box along the arrow direction.
2. Insert two AAA 1.5V dry batteries.
3. Reinstall the cover of battery box.

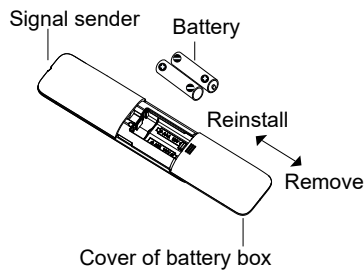

## TEST OPERATION

1. Plug in the power supply.
2. Press ON/OFF button on remote control to start the unit.
3. Press mode button to select auto, cooling, drying, fan or heating function, and then check if the unit operates normally.

**Note:** If ambient temperature is below 61°F(16°C), the unit cannot operate in cooling mode.

## OPERATION

### CONTROL PANEL

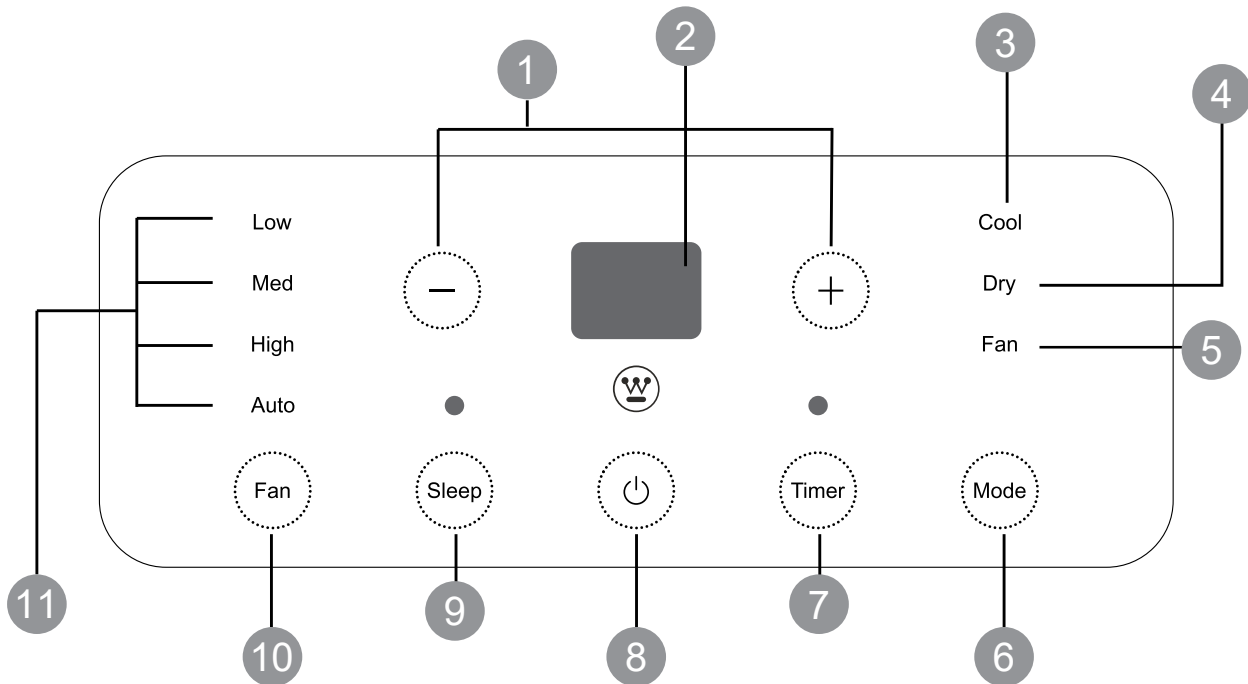

- +/- Buttons:** In cooling mode, press “+” or “-” button to increase or decrease set temperature by 1°F (°C). Set temperature range is 61°F (16°C)~86°F(30°C). In dry or fan mode, this button is invalid.
- Display:** Shows the set temperature in cooling mode.
- Cool Mode Indicator:** When lit, unit is operating in cool mode. The display shows set temperature. Temperature setting range is 61°F (16°C)~86°F(30°C).
- Dry Mode Indicator:** When lit, unit is operating in dry mode. Display will be blank.
- Fan Mode Indicator:** When lit, unit is operating in fan mode. Display will be blank.
- Mode Button:** Press this button to change modes (Cool > Dry > Fan)
- Timer Button:** Press this button and the mode will circulate according to below sequence:
- ON/OFF Button:** Use to turn the air conditioner on or off.
- Sleep Button:** Press sleep button to enter into sleep mode. If the controller operates at cooling mode, after sleep mode is started up, preset temperature will increase by 2°F(1°C) within 1 hour; preset temperature will increase by 4°F (2°C) within 2 hours and then the unit will operate at this temperature all the time; Sleep function is not available for fan mode or drying mode. If sleep function is started up, the upper indicator will keep the display status. Others, it won't be displayed.
- Fan Button:** Press to move through fan modes (Low speed > Medium speed > High speed > Auto)
- Fan Speed Indicator:** Lights to show current fan speed.

Press timer button to enter into timer setting mode. Under this mode, press “+” or “-“ button to adjust the timer setting. Timer setting will increase or decrease 0.5 hour by pressing “+” or “-“ button within 10 hours, while timer setting will increase or decrease 1 hour by pressing “+” or “-“ button beyond 10 hours. After timer setting is finished, the unit will display temperature if there's no operation for 5s. If timer function is started up, the upper indicator will keep the display status. Others, it won't be displayed. In timer mode, press timer button again to cancel timer mode

# OPERATION

---

## REMOTE CONTROL

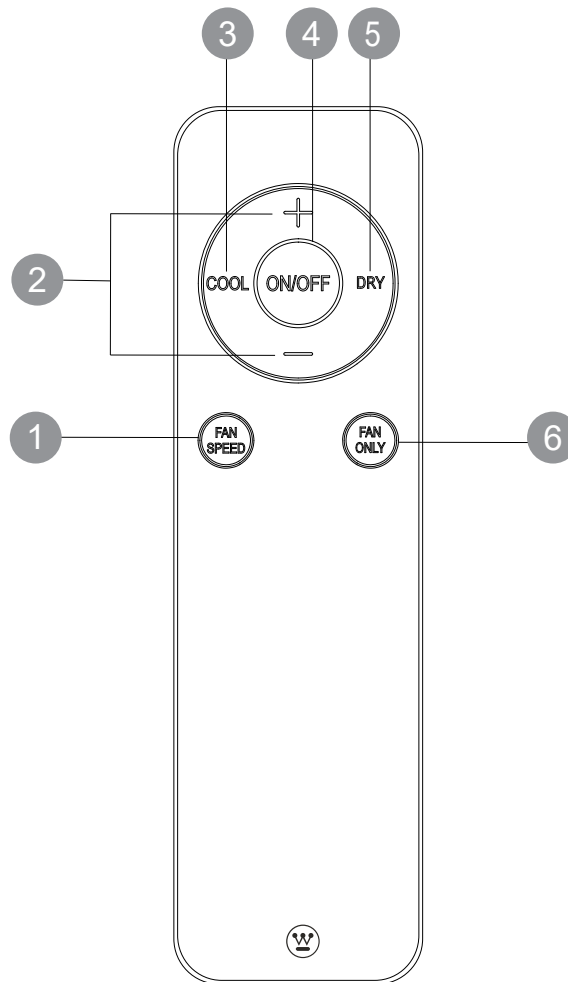

- 1. Fan Speed:** Press this button to set the fan speed at Auto, Low, Med or High..
- 2. +/-Buttons:** In cooling mode, press “+” or “-” button to increase or decrease set temperature by 1°F(°C).
- 3. Cool Mode:** Press to change operation to Cool mode.
- 4. ON/OFF:** Press this button to turn on or turn off the air conditioner.
- 5. Dry Mode:** Press to change operation to dry mode.
- 6. Fan Only:** Press to change operation to fan only mode.

## OPERATE THE UNIT

1. Open the louver by pressing the area marked PUSH on the front of the unit. Adjust this louver to direct air flow.

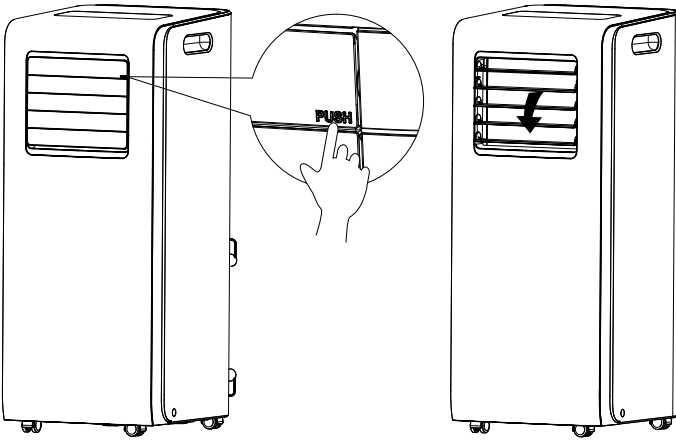

2. Press the ON/OFF button from the remote or from the control panel to start the unit.
3. Select operating mode (Cool, Fan, or Dry)
4. In cooling mode, use the +/- buttons to adjust the temperature.
5. Use the FAN SPEED button to adjust fan speed as required.

# CARE AND MAINTENANCE

## CARE AND MAINTENANCE

### ▲ WARNING

#### ELECTRIC SHOCK HAZARDS

Before cleaning the air conditioner, turn off the unit and disconnect power.

Do not spray or splash water or other liquids onto the unit; this may cause electric shock.

Do not use corrosive detergents to clean the appliance; this may damage the plastic components, and cause electric shock.

Do not use volatile liquids (such as paint thinner or gas) to clean the air conditioner. This may damage the appearance of air conditioner.

## CLEAN OUTER CASE AND GRILLE

If there's dust on the surface of outer case, use a soft towel to wipe it. If the outer case is very dirty or greasy, use a soft cloth dampened with mild detergent and water. Do NOT allow water to drip in to the unit.

Use cleaner or soft brush to clean the grille.

## CLEANING THE FILTER

1. Press the clasp as shown below, and then remove the filter.

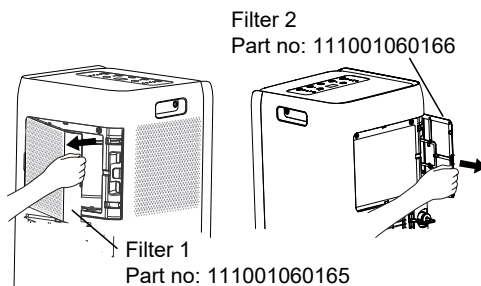

2. Use cleaner or water to clean the filter. If the filter is very dirty (such as grease), use warm water 104°F(40°C) mixed with mild detergent to clean it and then put it in a shady place to dry it.

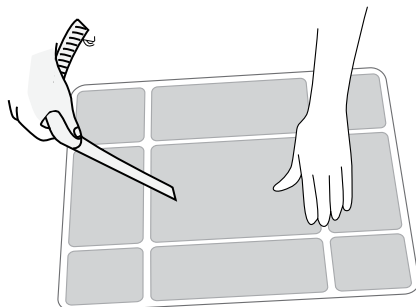

3. After the filter is cleaned and dried, reinstall it.

## CLEAN EXHAUST DUCT

1. Remove the exhaust duct from air conditioner, clean and dry it, and then reinstall it.

## EMPTY WATER FROM CHASSIS

If continuous discharge isn't possible, the unit must be periodically emptied.

During Cool mode or Auto mode, it is not recommended to remove the collected water. Leaving the water will improve performance and save energy.

During Dry mode, it is recommended to use the middle hole to drain outlet.

1. When the chassis is full of water, the unit will buzz 8 times and the display will show "H8."

2. Move the unit to a suitable place for discharging water.

**Note:** Do not tilt the unit--keep it vertical while moving.

3. Remove the rubber plug from the drainage port and allow the water to drain.

4. Replace the rubber plug on the drainage port.

5. After water has been emptied and the compressor has been stopped for 3 minutes, the unit will resume operation.

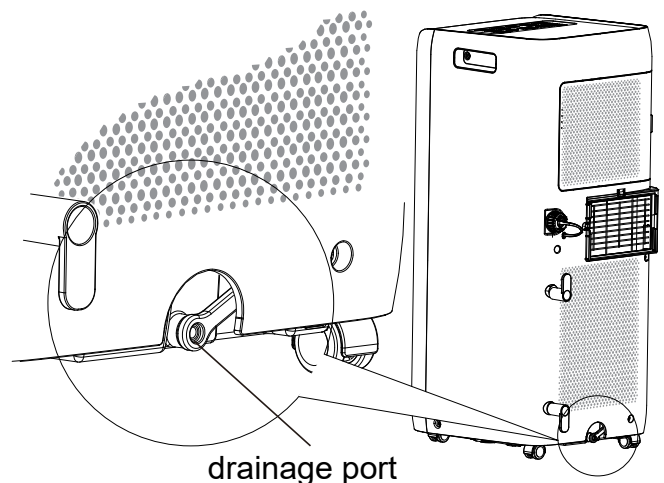

## CHECKING BEFORE USE-SEASON

- Check whether air inlets and air outlets are blocked.
- Check whether plug and socket are in good condition.
- Check whether filter is clean.
- Check whether batteries are installed in remote control.
- Ensure that exhaust connector, window bracket and exhaust duct are installed tightly.
- Check whether exhaust duct is damaged.



# CARE AND MAINTENANCE

---

## CHECKING AFTER USE-SEASON

1. Disconnect power supply.
2. Clean filter and outer case.
3. Eliminate accumulated water in chassis.
4. Check whether window bracket is damaged or not. If yes, please contact dealer.

## LONG-TERM STORAGE

If you don't use the air conditioner for a long time, please maintain it by following steps for good performance:

1. Make sure there's no accumulated water in chassis and the exhaust duct is disassembled.
2. Pull out the plug and wrap the power cord.
3. Clean the air conditioner and pack it well to prevent dust.

## NOTICE FOR RECOVERY

- Many packing materials are recyclable materials. Please deal with them through local recycle bin.
- If you want to throw away the air conditioner, please contact local hazardous waste disposal for the correct disposal method.

# TROUBLESHOOTING

## TROUBLESHOOTING

### TROUBLESHOOTING

Problem	Possible Cause	Solution
Air conditioner not operating	Power failure	Wait after power recovery.
	Loose plug	Reinsert the plug.
	Air switch is tripped or fuse is burnt	Have unit serviced to replace air switch or fuse.
	Is there malfunction for the circuit?	Have unit serviced to replace circuit.
	Unit is restarted too quickly after stopping	Wait for 3 minutes, and then turn on the unit again.
	Evaporator needs to be defrosted (observe it by pulling out the filter)	Normal phenomenon. Air conditioner is defrosting. After defrosting is finished, it will resume operation.
Poor cooling(heating)	Is an extension cord being used? (Can cause low input power.)	Move unit closer to power source, or use a shorter, heavier gauge extension cord.
	Air filter is too dirty	Clean the air filter.
	Set temperature is too low/high	Adjust the temperature.
	A door or window is open.	Close door and window.
Air conditioner can't receive signal from remote control or remote control is not sensible	The unit is interfered with seriously (such as static pressure, unstable voltage)	Unplug the unit wait three (3) minutes, plug in again, and then turn on the unit.
	Remote control is not within receiving range.	The receiving range of remote control is 8 meters. Do not exceed this range.
	The receiver on the air conditioner is blocked.	Remove the obstacles.
	Sensitivity of the remote control is low	Check the batteries of remote control. If the power is low, replace the batteries.
	There is a fluorescent lamp in the room.	Move the remote control close to air conditioner. Turn off the fluorescent lamp and try it again.
The unit is making a crackling sound.	Unit was recently turned off/on.	Heat expansion or shrinkage due to change of temperature.
Abnormal sound during operation	Interference from radio, thunderstorm, or other electrical activity.	Disconnect power, wait 3 minutes, then reconnect and turn on the unit again.
Unpleasant odor in the room	There is some odor source nearby (cigarettes, dirty rug, etc.)	Eliminate the source of the odor. Clean the filter.
No air blowing from air conditioner	Air outlet or air inlet is blocked	Eliminate the obstacles.
Set temperature can't be adjusted.	The required temperature exceeds the temperature setting range.	Temperature setting range: 61°F(16°C) 86°F(30°C).
You can heard water-flowing sound	The unit was just turned on or turned off.	Sound of refrigerant inside the air conditioner, which is normal.

# TROUBLESHOOTING

## ERROR CODES

Code	Solution
F1, F2, F4, F0	Please contact qualified professionals for service.
E8,H3	Check if the unit is under high-temperature and high-humidity environment; if ambient temperature is too high, power off the unit and then energize it for operation after the ambient temperature drops to 95°F(35°C) below.
	Check if the evaporator and condenser are blocked by some objects; if yes, take away the objects, power off the unit and then energize it for operation.
	If the malfunction still occur, please contact our after-sales service center.
H8	Pour out the water inside chassis. If "H8" still exist, please contact professional person to maintain the unit

# WARRANTY

---

## WARRANTY

### WESTINGHOUSE OUTDOOR POWER EQUIPMENT, LLC'S RESPONSIBILITY

Westinghouse Outdoor Power Equipment, LLC warrants to the original purchaser that its Westinghouse Outdoor Power Equipment, LLC line of portable air conditioners will be free from defects in material and workmanship. Under normal use and maintenance from the date of purchase, Westinghouse Outdoor Power Equipment, LLC agrees to repair or replace at Westinghouse Outdoor Power Equipment, LLC discretion, any defective product free of charge at any authorized Westinghouse Outdoor Power Equipment, LLC Authorized Service Dealer within the below listed applications, time periods, limitations, and exclusions. THIS LIMITED WARRANTY IS EXTENDED TO THE ORIGINAL PURCHASER ONLY AND IS NOT TRANSFERABLE TO SUBSEQUENT OWNERS. For a list of Westinghouse Outdoor Power Equipment, LLC Authorized Service Dealers refer to [www.wpowereq.com](http://www.wpowereq.com) or call 1-855-944-3571.

### OWNER'S RESPONSIBILITY

To ensure trouble free warranty coverage it is important that you register your Westinghouse Outdoor Power Equipment, LLC portable air conditioner. You may register on-line at [www.wpowereq.com](http://www.wpowereq.com), by automated phone at 1-855-944-3571, or by filling out and returning to Westinghouse Outdoor Power Equipment, LLC the warranty registration card supplied with your portable air conditioner. Registering your product confirms your warranty coverage and provides a direct link between you and Westinghouse Outdoor Power Equipment, LLC if we find it necessary to contact you.

Your receipt for purchase including date, model and serial number must be maintained and presented to a Westinghouse Outdoor Power Equipment, LLC Authorized Service Dealer for warranty service. Proof of purchase rests solely with you, the original purchaser.

You must demonstrate reasonable care and use and follow maintenance and storage guidelines prescribed in the operator's manual for your Westinghouse Outdoor Power Equipment, LLC unit. Should a product difficulty occur, you must, at your expense, deliver or ship your Westinghouse Outdoor Power Equipment, LLC unit to an Authorized Service Dealer for warranty repairs (which must occur within the applicable warranty period), and arrange for pick-up or return of your unit after the repairs have been made. For the Westinghouse Outdoor Power Equipment, LLC Authorized Service Dealer nearest to you, call Westinghouse Outdoor Power Equipment, LLC's automated phone at 1-855-944-3571 or may locate a Westinghouse Outdoor Power Equipment, LLC Authorized Service Dealer at [www.wpowereq.com](http://www.wpowereq.com) Should you require assistance or have questions concerning Westinghouse's Outdoor Power Equipment, LLC Warranty Statement, you can contact us through the web at [www.wpowereq.com](http://www.wpowereq.com) or call 1-855-944-3571.

### PRODUCT WARRANTY APPLICATIONS & PRODUCT WARRANTY PERIODS

#### CONSUMER APPLICATION

For the purpose of the limited warranty "Consumer Application" means use by the original purchaser for the purpose of personal residential household or recreational use.

Warranty: 1 year (12 months) for labor/1 year (12 months) for parts (manufacturing defects only)/and a total of 5 years (60 months) for compressor part only.

Westinghouse Outdoor Power Equipment, LLC may, at its discretion, replace the defective product with either a new or remanufactured unit equivalent to your original purchase during the warranty period.

If proof of purchase is not available to establish the purchase date nor is the equipment registered as suggested herein, the date of manufacturing as recorded by Westinghouse Outdoor Power Equipment, LLC will start the product warranty period.

#### EXCLUSIONS

Westinghouse Portable Air Conditioners that use non-Westinghouse replacement parts.

Costs of normal maintenance and adjustments.

Repairs or diagnostics performed by individuals other than Westinghouse Outdoor Power Equipment, LLC Authorized Dealers not authorized in writing by Westinghouse.

Products that have been purchased as refurbished, like new, or second-hand.

Failures caused by any external cause, including but not limited to, collision, theft, vandalism, riot, war, fire, freezing, lightning, earthquake, windstorm, hail, water, flood, tornado, or hurricane.

# WARRANTY

---

Damage related to rodent and/or insect infestation.

Failure as a result of improper installation and usage as described in the User's Manual.

Products that are modified or altered in a manner not authorized in writing by Westinghouse Outdoor Power Equipment, LLC.

Any incidental, consequential or indirect damages caused by defects in materials or workmanship, or any delay in repair or replacement of the defective part(s).

Failure due to misapplication.

Telephone, cellular phone, facsimile, internet access, or other communication expenses.

Expenses related to "customer instruction" or troubleshooting where no manufacturing defect is found.

Overnight freight or special shipping costs for replacement parts(s).

Overtime, holiday or emergency labor.

## **DISCLAIMER OF IMPLIED WARRANTIES**

This limited warranty is in lieu of all other expressed or implied warranties, including any warranty of FITNESS FOR A PARTICULAR PURPOSE OR USE and any implied warranty MERCHANTABILITY otherwise applicable to Westinghouse Outdoor Power Equipment, LLC's line of Westinghouse's line of Portable Air Conditioners and its affiliated companies shall not be liable for any special, incidental or consequential damage, including lost profits. There are no warranties extended other than as provided herein. This limited warranty may be modified only by Westinghouse Outdoor Power Equipment, LLC. Any implied warranties allowed by law shall be limited in duration to the terms of the express warranty provided herein. Some states do not allow the exclusion or limitation of incidental or consequential damages, so the above limitation may not apply to you. This warranty gives you specific legal rights. You also have other rights from state to state. Westinghouse Outdoor Power Equipment, LLC'S ONLY LIABILITY SHALL BE THE REPAIR OR REPLACEMENT AS STATED ABOVE. IN NO EVENT SHALL WESTINGHOUSE BE LIABLE FOR ANY INCIDENTAL OR CONSEQUENTIAL DAMAGES, EVEN IF SUCH DAMAGES ARE A DIRECT RESULT OF Westinghouse Outdoor Power Equipment, LLC'S NEGLIGENCE. Some states do not allow the exclusion or limitation of incidental or consequential damages, so the above limitation may not apply to you. This warranty gives you specific legal rights and you may also have other rights from state to state.

This limited warranty is given by Westinghouse Outdoor Power Equipment LLC (777 Manor Park Drive, Columbus, OH 43228).



**WestinghouseOutdoorPower.com**

**Service Hotline: (855) 944-3571**

**777 Manor Park Drive  
Columbus, OH 43228**

**® and Westinghouse are trademarks of Westinghouse Electric Corporation.  
Used under license by Westinghouse Outdoor Power Equipment. All Rights Reserved**

WPAC8000 & WPAC10000  
66139902592 Rev02 03/22