



iGen2200c

Digital Inverter Generator

1800 Running Watts | 2200 Peak Watts

DO NOT RETURN THIS PRODUCT TO THE STORE

If you have questions or need assistance, please call customer service at 855-944-3571.

INTRODUCTION

INTRODUCTION

TABLE OF CONTENTS

INTRODUCTION

DISCLAIMERS	2
ALL RIGHTS RESERVED.....	2
SPECIFICATIONS.....	3

SAFETY

SAFETY DEFINITIONS.....	4
SAFETY SYMBOLS.....	4
SAFETY INSTRUCTIONS	5
GENERAL SAFETY PRECAUTIONS	6
SAFETY LABELS AND DECALS.....	7
CO SENSOR.....	8
ACTION LABEL.....	8
CONTROL PANEL CO AUTO-SHUTOFF	8

COMPONENTS

GENERATOR COMPONENTS.....	9
CONTROL PANEL COMPONENTS.....	10

ASSEMBLY

CARTON CONTENTS	11
INITIAL OIL FILL	11
FUEL	11
FILLING THE FUEL TANK	12

OPERATION

GENERATOR LOCATION.....	13
HIGH ALTITUDE OPERATION	13
BREAK-IN PERIOD	14
BEFORE STARTING THE GENERATOR.....	14
STARTING THE ENGINE	14
FREQUENCY OF USE	14

ECO MODE.....	15
AC CIRCUIT BREAKER.....	15
OVERLOAD RESET	15
POWER MANAGEMENT.....	16
EXTENSION CORDS	16
PARALLEL OPERATION.....	17
TRANSPORTING.....	17

MAINTENANCE

MAINTENANCE SCHEDULE	18
MAINTENANCE REPLACEMENT PARTS	18
ENGINE SERVICE COVER.....	18
AIR FILTER MAINTENANCE.....	18
ENGINE OIL LEVEL CHECK.....	19
ENGINE OIL CHANGE	19
SPARK PLUG MAINTENANCE	20
SPARK ARRESTOR SERVICE.....	20
STORAGE.....	21
VALVE CLEARANCE	22

TROUBLESHOOTING

TROUBLESHOOTING.....	23
----------------------	----

EXPLODED VIEW AND PARTS LISTS

EXPLODED VIEW A	24
EXPLODED VIEW B.....	26

SCHEMATIC

SCHEMATIC	29
-----------------	----

ESPAÑOL.....	30
--------------	----

FRANÇAIS.....	55
---------------	----

⚠ WARNING: Operating, servicing, and maintaining this equipment can expose you to chemicals including engine exhaust, carbon monoxide, phthalates, and lead, which are known to the State of California to cause cancer and birth defects or other reproductive harm. To minimize exposure, avoid breathing exhaust, and wear gloves or wash your hands frequently when servicing this equipment. For more information go to www.P65warnings.ca.gov.

DISCLAIMERS

All information, illustrations, and specifications in this manual were in effect at the time of publishing. The illustrations used in this manual are intended as representative reference views only. We reserve the right to make any specification or design change without notice.

ALL RIGHTS RESERVED

All rights reserved. No reproduction allowed in any form without written permission from Westinghouse Outdoor Power Equipment, LLC.

⚠ DANGER



Read this manual before using or performing maintenance on this product. Failure to follow the instructions and safety precautions in this manual can result in serious injury or death.

SAVE THESE INSTRUCTIONS

INTRODUCTION

SPECIFICATIONS

Specifications	
Running Watts:	1800
Peak Watts:	2200
Rated Power @1.0 Power Factor:	1.8 kW Gasoline
Peak Power:	2.2 kVA Gasoline
Rated Voltage:	120V
Rated frequency:	60 Hz @ 3600 RPM
Phase:	Single phase
Total Harmonic Distortion:	≤ 3%
Engine Displacement:	79 cc
Starting Type:	Recoil
Fuel Capacity:	1.14 Gallons (4.3 Liters)
Fuel Type:	Unleaded gasoline 87–93 Octane*
Oil Capacity:	.37 qt. (11.8 oz.)
Oil Type:	SAE 10W-30
Spark Plug:	Torch E6RTC
Spark Plug Gap:	0.024 – 0.032 in. (0.60 – 0.80 mm)
Valve Intake Clearance:	0.0031 – 0.0047 in. (0.08 – 0.12 mm)
Valve Exhaust Clearance:	0.0051 – 0.0067 in. (0.13 – 0.17 mm)
AC Grounding System:	Floating neutral
Voltage Regulator:	AVR
Alternator Type:	Permanent magnet
Maximum Ambient Temperature:	104°F (40°C)
Certifications:	<ul style="list-style-type: none">• EPA• CARB• CSA Group

* Ethanol content of 10% or less. DO NOT use E15 or E85.

NOTICE

This product is designed and rated for continuous operation at ambient temperatures up to 104°F (40°C). If needed, this product can be operated at temperatures ranging from 5°F (15°C)–122°F (50°C) for short periods. If the product is exposed to temperatures outside of this range during storage, it should be brought back within this range before operation. This product must always be operated outdoors in a well-ventilated area and far away from doors, windows, and other vents.

Maximum wattage and current are subject to and limited by such factors as fuel BTU content, ambient temperature, altitude, engine conditions, etc. Maximum power decreases about 3.5% for each 1,000 feet above sea level, and will also decrease about 1% for each 10°F (6°C) above 60°F (16°C) ambient temperature.

PRODUCT REGISTRATION

For trouble-free warranty coverage, it is important to register your Westinghouse generator.

You can register by:

- Completing and mailing the product registration card included in the carton.
- Registering your product on-line at: <https://westinghouseoutdoorpower.com/pages/warranty-registration>
- Scan the following QR code with your smartphone camera to be directed to the mobile registration link.



- Sending the following product information to:

Westinghouse Outdoor Power
Warranty registration
777 Manor Park Drive
Columbus, OH 43228

For Your Records

Date of Purchase: _____

Model Number: _____

Serial Number: _____

Place of Purchase: _____

IMPORTANT: Keep your purchase receipt for trouble-free warranty coverage.

SAFETY

SAFETY

SAFETY DEFINITIONS

The words DANGER, WARNING, CAUTION, and NOTICE are used throughout this manual to highlight important information. Make sure that the meanings of this safety information is known to all who operate, perform maintenance on, or are near the generator.



This safety alert symbol appears with most safety statements. It means attention, become alert, your safety is involved! Please read and abide by the message that follows the safety alerts symbol.

⚠ DANGER

Indicates a hazardous situation which, if not avoided, will result in death or serious injury.

⚠ WARNING

Indicates a hazardous situation which, if not avoided, could result in death or serious injury.

⚠ CAUTION

Indicates a hazardous situation which, if not avoided, could result in minor or moderate injury.

NOTICE

Indicates a situation which can cause damage to the generator, personal property, and/or the environment, or cause the equipment to operate improperly.

Note: Indicates a procedure, practice or condition that should be followed for the generator to function in the manner intended.

SAFETY SYMBOLS

Follow all safety information contained in this manual and on the generator.

Symbol	Description
	Safety Alert Symbol
	Electrocution Hazard
	Asphyxiation Hazard
	Burn Hazard. Do not touch hot surfaces.
	Electrical Shock Hazard
	Fire Hazard
	Maintain Safe Distance
	Read Manufacturer's Instructions
	Do Not Operate in Wet Conditions
	Ground. Consult with electrician to determine grounding requirements before operation.

⚠ DANGER

Using a generator indoors CAN KILL YOU IN MINUTES. Generator exhaust contains carbon monoxide. This is a poison you cannot see or smell.



NEVER use inside a home or garage, EVEN IF doors and windows are open.



Only use OUTSIDE and far away from windows, doors, and vents.

SAFETY INSTRUCTIONS

CORRECT USAGE

Example location to reduce risk of carbon monoxide poisoning

- ONLY use outside and downwind, far away from windows, doors and vents.
- Direct exhaust away from occupied spaces

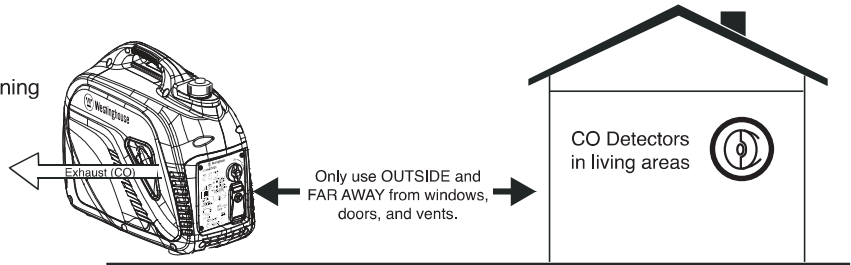

INCORRECT USAGE

Do not operate in any of the following locations:

- Near any door, window, or vent
- Garage
- Basement
- Crawl Space
- Living Area
- Attic
- Entry Way
- Porch
- Mudroom

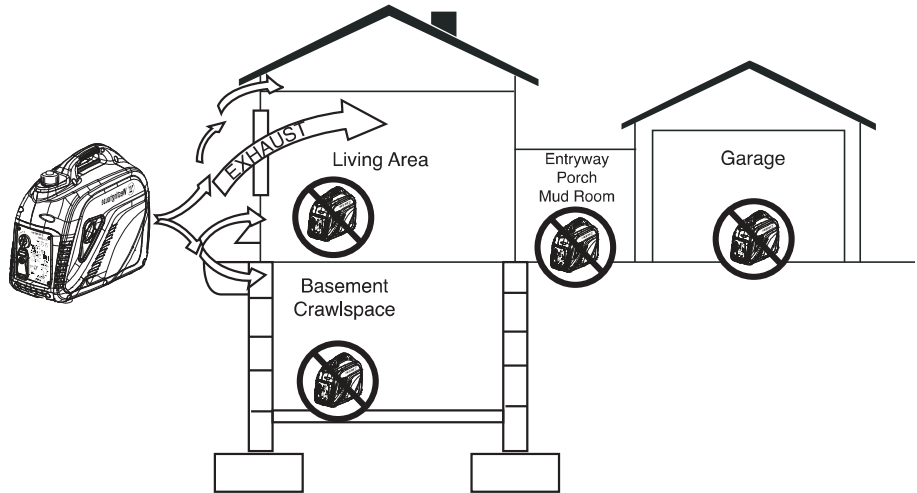

NOTICE

Install battery-powered carbon monoxide detectors or plug-in carbon monoxide detectors with battery back-up in living areas.

⚠ DANGER

Fire and electrocution hazard. Do not connect to a building's electrical system unless the generator and transfer switch have been properly installed and the electrical output has been verified by a qualified electrician. The connection must isolate the generator power from utility power and must comply with all applicable laws and electrical codes.

⚠ DANGER

Electrocution hazard. Never use the generator in a location that is wet or damp. Never expose the generator to rain, snow, water spray, or standing water while in use. Protect the generator from all hazardous weather conditions. Moisture or ice can cause a short circuit or other malfunction in the electrical circuit.

SAFETY

GENERAL SAFETY PRECAUTIONS

- Never use the generator to power medical support equipment.
- Do not operate the generator when you are tired or under the influence of drugs, alcohol, or medication.
- Do not use generator with electrical cords which are worn, frayed, bare, or otherwise damaged.
- All electrical tools and appliances operated from this generator must be properly grounded by use of a third wire or be double-insulated.
- When this generator is used to supply a building wiring system the generator must be installed by a qualified electrician and connected to a transfer switch as a separately derived system in accordance with NFPA 70, National Electrical Code.
- If you begin to feel sick, dizzy, or weak while using the generator, move to fresh air IMMEDIATELY. See a doctor, as you can have carbon monoxide poisoning.
- Only use OUTSIDE and far away from windows, doors, and vents as recommended by the US Department of Health and Human Services Centers for Disease Control and Prevention. Your specific home and/or wind conditions may require additional distance.
- While operating and storing, keep at least five feet of clearance on all sides of the generator, including overhead. Allow the generator to cool a minimum of 30 minutes before storage. Heat created by the muffler and exhaust gases could be hot enough to cause serious burns and/or ignite combustible objects.
- Do not touch the muffler or engine. They are very HOT and will cause severe burns. Do not put body parts or any flammable or combustible materials in the direct path of the exhaust.
- Always remove any tools or other service equipment used during maintenance away from the generator before operating.
- Avoid skin contact with engine oil or gasoline. Wear protective clothing and equipment. Wash all exposed skin with soap and water.
- A transfer switch must be installed by a licensed electrician approved by the authority having jurisdiction. The installation must comply with all applicable laws and electrical codes.

FUEL SAFETY

- Store fuel in a container approved for gasoline.
- Do not smoke when filling the generator with gasoline.
- Do not allow the generator's gas tank to overflow when filling.
- Shut down the engine and allow it to cool for two minutes before adding gasoline or oil to the generator.
- Never remove the fuel cap when the generator is running. Shut off the engine and allow the unit to cool

at least five minutes. Remove the fuel cap slowly to release pressure, keep fuel from escaping around the cap, and to avoid the heat from the muffler igniting fuel vapors. Tighten the fuel cap securely after refueling.

- Wipe spilled fuel from the unit.
- Never attempt to burn off spilled fuel.
- Never overfill the fuel tank. Leave room for fuel to expand. Overfilling the fuel tank can result in a sudden overflow of gasoline and result in spilled gasoline coming in contact with HOT surfaces.
- Spilled fuel can ignite. If fuel is spilled on the generator, wipe up any spills immediately. Dispose of rag properly. Allow area of spilled fuel to dry before operating the generator.
- Wear eye protection while refueling.
- Never use gasoline as a cleaning agent.
- Store any containers containing gasoline in a well-ventilated area, away from any combustibles or source of ignition.

GASOLINE AND GASOLINE VAPOR (GAS)

▲ DANGER

Fire and explosion hazard. Gasoline is highly explosive and flammable and can cause severe burns or death.

- In case of a gas fire, do not attempt to extinguish the flame if the fuel tank valve is in the ON position. Introducing an extinguisher to a generator with an open fuel switch could create an explosion hazard.
- Gas has a distinctive odor, this will help detect potential leaks quickly.
- Gas vapors can cause a fire if ignited.
- Gasoline is a skin irritant and needs to be cleaned up immediately if it comes in contact with the skin.

When starting the generator:

- Make sure that the fuel cap, air filter, spark plug, fuel lines, and exhaust system are properly in place.
- If you spill any gasoline on the tank, allow it to fully evaporate before operating.
- Make sure the generator is on a flat surface before operating.

When transporting or servicing the generator:

- Disconnect the spark boot to prevent accidental starting.

When storing the generator:

- Store away from sparks, open flames, pilot lights, heat, and other sources of ignition.
- Do not store gasoline near furnaces, water heaters, or any other appliances that produce heat or have automatic ignitions.

SAFETY LABELS AND DECALS

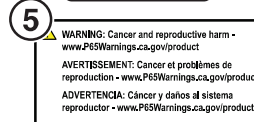
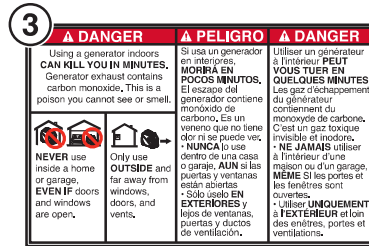
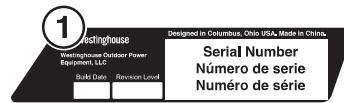
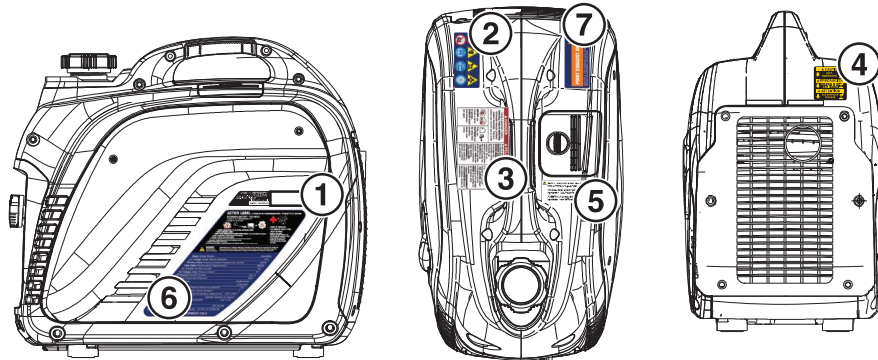

6 ACTION LABEL | ETIQUETA DE FUNCIONAMIENTO | ÉTIQUETTE D'ACTION

AUTOMATIC SHUTOFF - YOU MUST:
ETIQUETA DE FUNCIONAMIENTO:
ÉTIQUETTE D'ACTION:

▲ DANGER ▲ PELIGRO ▲ DANGER

MOVE GENERATOR TO AN OPEN, OUTDOOR AREA.
POINT EXHAUST AWAY.
DO NOT RUN GENERATOR IN ENCLOSED AREAS (e.g., NOT IN HOUSE OR GARAGE).

MOVES EL GENERADOR A UN ESPACIO ABIERTO AL EXTERIOR.
DIRIGIR EL TUBO DE ESCAPE HACIA AFUERA.
NO EJECUTAR EL GENERADOR EN ÁREAS CERRADAS (p.e.j. EN UNA CASA O GARAJE).

REPLACER LA GÉNÉRATRICE DANS UN ESPACE EXTÉRIEUR OUVERT

NE PAS FAIRE FONCTIONNER LA GÉNÉRATRICE DANS DES ENDROITS FERMÉS (comme dans la maison ou le garage).

WARNING
ADVERTENCIA
AVERTISSEMENT

TAMPERING WITH CARBON MONOXIDE SENSOR COULD RESULT IN HAZARDOUS CONDITION
HACER ALTERACIONES CON SENSOR DE MONÍTORO DE CARBONO PODRÍA OCASIONAR CONDICIONES PELIGROSAS
L'INTERVENTION DE CAPTEUR DE MONITEUR DE CARBONE PEUT ENTRAINER DES SITUATIONS DANGEREUSES

Modelo / Modelo / Modèle	iGen2200c
AC Voltage / Voltaje / Tension alternative	120V
Running Watts / Potencia (nominal) / Puissance (en marche)	1800W
Peak Watts / Potencia (pico) / Puissance (pic)	2200W
AC Current / Corriente / Courant	15A
DC Voltage / Voltaje / Tension continue	5V
DC Current / Corriente / Courant	2x2.1A
Frequency / Frecuencia / Fréquence	60Hz
Phase / Fase / Phase	Single / Soltero
RPM / TR / tr/min	up to 3400
Power Factor / Factor de potencia / Facteur de puissance	1.0
Insul Class / Clase de aislamiento / Classe d'isolation	F
Max Amb Temp / Temperatura máxima / Température ambiante max.	40°C (104°F)
Fuel / Combustible / Carburant	Gasoline / Gasolina / De l'essence
Fuel Tank Size / Tamaño del tanque de combustible / Taille du réservoir de carburant	4.3L/1.14G
Oil / Aceite de motor / Huile moteur	SAE10W-30
Oil Capacity / Capacidad de aceite / Capacité d'huile	.37 QT/11.8 OZ/350 ML

FOR ELECTRICAL EQUIPMENT ONLY



SAFETY

CO SENSOR

The CO sensor monitors for the accumulation of poisonous carbon monoxide gas around the generator when the engine is running. If increasing levels of CO gas are detected, the CO Sensor automatically shuts down the engine.

The CO Sensor will also detect the accumulation of carbon monoxide from other fuel burning sources used in the area of operation. For example, if the exhaust of fuel burning tools is pointed at a CO Sensor-equipped generator, a shut-off may be initiated due to rising CO levels. This is not an error. Hazardous carbon monoxide has been detected. Move and redirect any additional fuel burning sources to dissipate carbon monoxide away from personnel and occupied buildings.

Note: Remote start-equipped generators must be restarted with the START/STOP button on the control panel after an automatic shut-down occurs.

Generators are intended to be used outdoors, far from occupied buildings and the exhaust pointed away from personnel and buildings. If misused and operated in a location that results in the accumulation of CO, like in a partially enclosed area, the CO Sensor shuts off the engine, notifies the user with a RED indicator light, and directs the user to read the Action Label for steps to take. The CO Sensor **DOES NOT** replace carbon monoxide alarms. Install battery-powered carbon monoxide alarm(s) in your home.

CONTROL PANEL CO AUTO-SHUTOFF

CARBON MONOXIDE AUTO-SHUTOFF



CO SENSOR INDICATOR LIGHTS

Color	Description
RED	<p>Carbon monoxide accumulated around the generator. After shut-off, the RED indicator light in the CO Sensor area of the control panel will flash to provide notification that the generator was shut-off due to an accumulating CO hazard. The RED light will flash for at least five minutes after a CO shut-off.</p> <p>Move the generator to an open, outdoor area far away from occupied spaces with exhaust pointed away. Once relocated to a safe area, the generator can be restarted. Introduce fresh air and ventilate the area where the generator had shut down.</p>
YELLOW	<p>A CO sensor system fault occurred. When a system fault occurs, the generator is automatically shut down and the YELLOW indicator light in the CO auto-shutoff area of the control panel will flash to provide notification that the a fault has occurred. The YELLOW light will flash for at least five minutes after a fault. The generator can be re-started, but may continue to shutoff. A CO sensor fault can only be diagnosed and repaired by an authorized Westinghouse service center.</p>

⚠ WARNING

Automatic shutoff accompanied with a flashing RED light in the CO Sensor portion of the control panel is an indication that the generator was improperly located. If you start to feel sick, dizzy, weak, or carbon monoxide detectors in your home indicate an alarm, get to fresh air immediately. Call emergency services. You may have carbon monoxide poisoning.

ACTION LABEL

ACTION LABEL
ETIQUETA DE FUNCIONAMIENTO
ÉTIQUETTE D'ACTION

AUTOMATIC SHUTOFF - YOU MUST:
ETIQUETA DE FUNCIONAMIENTO:
ÉTIQUETTE D'ACTION:

- MOVE GENERATOR TO AN OPEN, OUTDOOR AREA.
- POINT EXHAUST AWAY.
- DON'T RUN GENERATOR IN ENCLOSED AREAS (E.G. NOT IN HOUSE OR GARAGE).
- MOVER EL GENERADOR A UN ÁREA ABIERTA, EN EXTERIORES
- ORIENTAR EL TUBO DE ESCAPE HACIA AFUERA
- NO ACTIVAR EL GENERADOR EN ÁREAS CERRADAS (P. E.L: EN UNA CASA O GARAJE)
- DÉPLACER LA GÉNÉRATRICE DANS UN ESPACE EXTÉRIEUR OUVERT
- DIRIGER L'ÉCHAPPEMENT LOIN DE VOUS
- NE PAS FAIRE FONCTIONNER LA GÉNÉRATRICE DANS DES ENDROITS FERMÉS (COMME DANS LA MAISON OU LE GARAGE)

- MOVE TO FRESH AIR.
- GET MEDICAL HELP IF SICK, DIZZY OR WEAK.
- MOVER AL AIRE LIBRE
- OBTENER ATENCIÓN MÉDICA SI SE SIENTE ENFERMO, MAREADO O DÉBIL
- VOUS RETIRER À L'AIR FRAIS
- CONSULTER UN MÉDECIN SI VOUS ÊTES MALADE, ÉTOURDI OU FAIBLE

POINT
ORIENTAR
DIRIGIR

EXHAUST
EL TUBO DE ESCAPE
L'ÉCHAPPEMENT

AWAY
HACIA AFUERA
LOIN DE VOUS

WARNING
ADVERTENCIA
AVERTISSEMENT

TAMPERING WITH CARBON MONOXIDE SENSOR COULD RESULT IN HAZARDOUS CONDITION
HACER ALTERACIONES CON SENSOR DE MONÓXIDO DE CARBONO PODRÍA OCASIONAR CONDICIONES PELIGROSAS
L'ALTÉRATION DE CAPTEUR DE MONOXYDE DE CARBONE PEUT ENTRAÎNER DES CONDITIONS DANGEREUSES

COMPONENTS

COMPONENTS

GENERATOR COMPONENTS

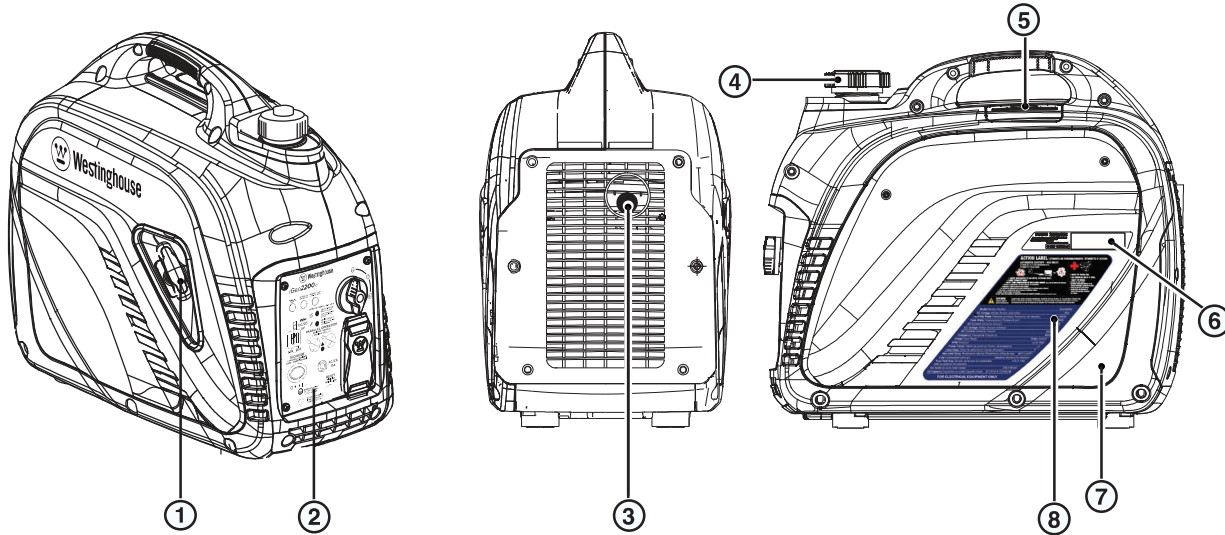

1.	Recoil Handle: Pull the recoil handle to manually start the engine.
2.	Control Panel: The control panel contains the outlets and operational controls.
3.	Muffler and Spark Arrestor: The spark arrestor prevents sparks from exiting the muffler.
4.	Fuel Cap: Add unleaded fuel here.

5.	Spark Plug Access Cover: Cover provides access to the spark plug.
6.	Serial Number: The model serial number required for product registration can be located in one of two locations.
7.	Engine Service Cover: Cover provides access to the engine, air cleaner, and carburetor.
8.	Model Information Label: Provides voltage/amps, and power rating information.

COMPONENTS

CONTROL PANEL COMPONENTS

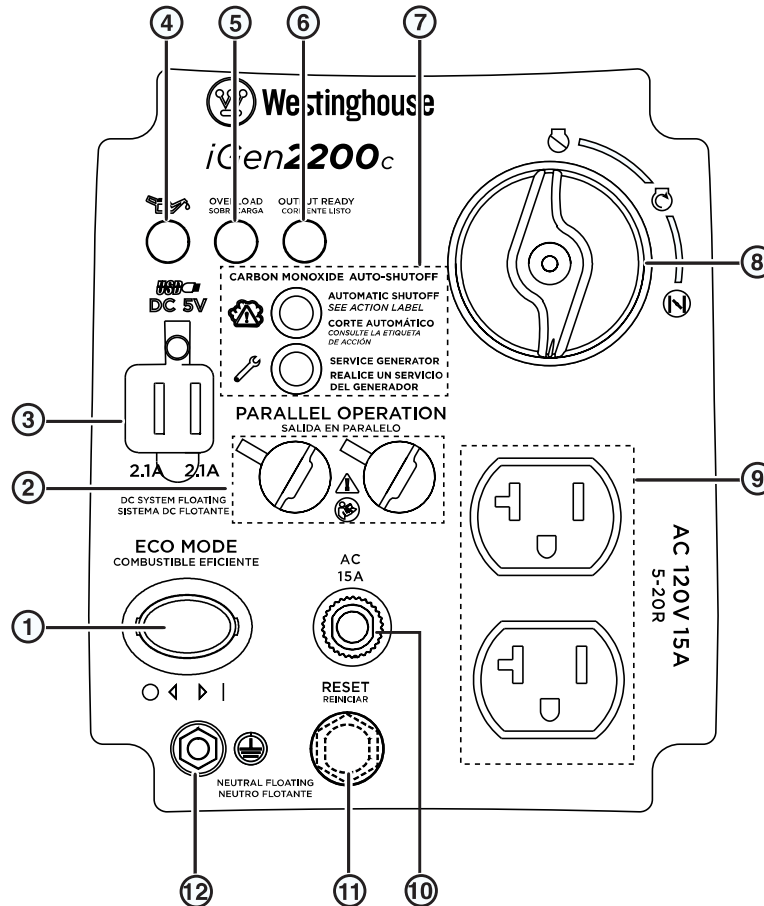

1.	Eco Mode: Eco mode minimizes fuel consumption and noise by adjusting the engine RPM to the minimum required for the current load.
2.	Parallel Operation Outlets: A compatible Westinghouse Inverter Generator can be connected for additional power output.
3.	USB Ports: Two-port 5V/2.1A USB outlet. Accepts Type A USB plugs.
4.	Low Oil LED: Indicates low oil level. When the oil level in the crankcase falls below the safe operating limit, the low oil level indicator will illuminate and the generator will automatically shut off the engine.
5.	Overload LED: Indicates that the generator is overloaded.
6.	Output Ready LED: Illuminates when the generator is operating normally. Indicates the generator is producing electrical power at the receptacles.

7.	CO Sensor indicator lights: The CO Sensor monitors for the accumulation of poisonous carbon monoxide gas. If increasing levels of CO gas are detected, the CO Sensor automatically shuts down the engine.
8.	Fuel Switch: Used to turn fuel knob to the run (ON), choke, or OFF position.
9.	120 Volt AC, 20 Amp Duplex NEMA 5-20R Receptacle: Receptacle can supply a maximum of 20 Amps.
10.	15 Amp AC Circuit Breaker: Circuit breaker limits the current that can be delivered through the NEMA 5-20R receptacle to 15 Amps.
11.	Overload Reset: The generator inverter will automatically switch OFF all AC output to protect the generator if overloaded or if there is a short circuit in a connected appliance.
12.	Ground Terminal: The ground terminal is used to externally ground the generator.

ASSEMBLY

CARTON CONTENTS

1. Carefully open the carton.
2. Remove and save the carton contents.
3. Remove and discard the packing materials.
4. Unfold the top of the plastic bag enclosing the generator.
5. Carefully cut the vertical corners of the carton to access the generator.
6. Recycle or dispose of the packaging materials properly.

CARTON CONTENTS

- User manual
- Quick Start Guide/Maintenance Schedule
- 0.37 US qt (350 ml) bottle of SAE 10W-30 Oil
- Spark plug socket wrench
- Oil Funnel

If any parts are missing, contact our service team at service@wpowerreq.com or call 1-855-944-3571.

INITIAL OIL FILL

NOTICE

THIS GENERATOR HAS BEEN SHIPPED WITHOUT OIL. Do not attempt to crank or start engine before it has been properly serviced with recommended oil. Failure to add engine oil before starting will result in serious engine damage.

NOTICE

Use of 2-stroke/cycle oil or other unapproved oil types can cause severe engine damage that is not covered under warranty.

The included, recommended oil type for typical use is 10W-30 engine oil. If running the generator in extreme temperatures, refer to the following chart.

Recommended Engine Oil Type									
		10W-30							
	5W-30					10W-40			
	5W-30 Synthetic								
°F	-20	0	20	40	60	80	100	120	
°C	-28.9	-17.8	-6.7	4.4	15.6	26.7	37.8	48.9	
Ambient temperature									

1. On a level surface, remove the engine service cover and oil dipstick.

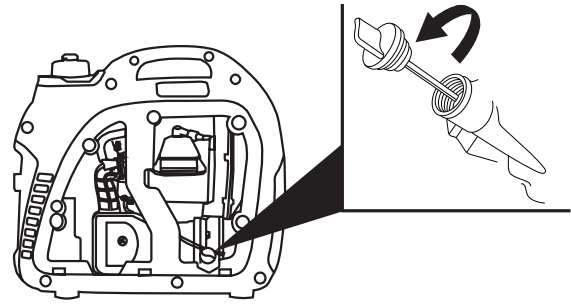

2. Using the supplied funnel and oil, add oil into the engine.

Note: As residual oil from the factory may remain in the engine, add the oil incrementally near the end of the bottle to prevent overfilling the engine. See Engine Oil Level Check in the Maintenance section.

3. Replace the oil dipstick and hand-tighten.
4. Replace the engine service cover.

FUEL

⚠ WARNING

Fire and explosion hazard. Never use a gasoline container, gasoline tank, or any other fuel item that is broken, cut, torn or damaged.

⚠ DANGER

Fire and explosion hazard. Do not overfill fuel tank. Fill only to the red fill ring located in the in-tank fuel screen filter. Overfilling may cause fuel to spill onto engine causing a fire or explosion hazard.

⚠ DANGER

Fire and explosion hazard. Never refuel the generator while the engine is running. Always turn the engine off and allow the generator to cool for two minutes before refueling.

NOTICE



Do not use E15 or E85 fuel in this product. Engine or equipment damage caused by stale fuel or the use of unapproved fuels (such as E15 or E85 ethanol blends) is not covered by warranty. Only use unleaded gasoline containing up to 10% ethanol.

ASSEMBLY

FUEL REQUIREMENTS

- CLEAN, FRESH, unleaded gasoline, 87–93 octane.
- Up to 10% ethanol (gasohol) is acceptable (where available; non-ethanol fuel is recommended).
- DO NOT use E85 or E15.
- DO NOT use a gas oil mix.
- DO NOT modify the engine to run on alternate fuels.
- DO NOT fuel indoors.
- DO NOT create a spark or flame while fueling.

USING FUEL STABILIZER

Adding a fuel stabilizer (not included) extends the usable life of fuel and helps prevent deposits from forming that can clog the fuel system. Follow the manufacturer's instructions for use.

Always mix the correct amount of fuel stabilizer to gasoline in an approved gasoline container before fueling the generator. Run the generator for five minutes to allow the stabilizer to treat the entire fuel system.

FILLING THE FUEL TANK

1. Turn the generator OFF and allow to cool for a minimum of two minutes before fueling.
2. Place the generator on level ground in a well ventilated area.
3. Clean area around fuel cap and remove the cap slowly.

NOTICE

Only fill the tank from an approved gasoline container. Make sure the gasoline container is internally clean and in good condition to prevent fuel system contamination.

4. Slowly add the recommended fuel. Do not overfill. Fill only to the red maximum fill ring on the fuel screen filter visible in the filler neck.

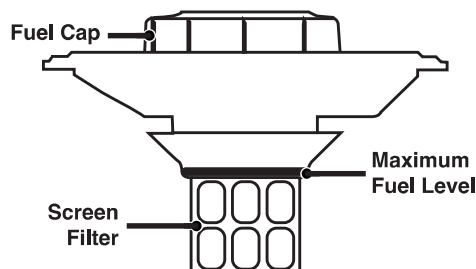

5. Install the fuel cap. Tighten securely.

NOTICE

Fuel can damage paint and plastic. Use caution when filling the fuel tank. Damage caused by spilled fuel is not covered under warranty.

NOTICE



Clean the fuel screen filter of debris before and after each fueling. Remove the fuel screen filter by slightly compressing it while removing it from the fuel tank.

OPERATION

OPERATION

GENERATOR LOCATION

Read and understand all safety information before starting the generator.

⚠ DANGER	
Using a generator indoors CAN KILL YOU IN MINUTES. Generator exhaust contains carbon monoxide. This is a poison you cannot see or smell.	
	
NEVER use inside a home or garage, EVEN IF doors and windows are open.	Only use OUTSIDE and far away from windows, doors, and vents.

NEVER operate the generator inside any building, including garages, basements, crawlspaces, sheds, enclosure, or compartment, including the generator compartment of a recreational vehicle.

⚠ DANGER
Electrocution hazard. Never use the generator in a location that is wet or damp. Never expose the generator to rain, snow, water spray, or standing water while in use. Protect the generator from all hazardous weather conditions. Moisture or ice can cause a short circuit or other malfunction in the electrical circuit. Using a generator or electrical appliance in wet conditions, such as rain or snow, or near a pool or sprinkler system, or when your hands are wet, could result in electrocution

⚠ WARNING
Fire hazard. Only operate the generator on a solid, level surface. Operating the generator on a surface with loose material such as sand or grass clippings can cause debris to be ingested by the generator that could block cooling vents or the air intake system. Allow the generator to cool for 30 minutes before transport or storage.

The generator should be on a flat, level surface at all times (Even while not in operation). The generator must have at least 5 ft. (1.5 m) of clearance from all combustible material.

Do not operate the generator in the back of a SUV, camper, trailer, truck bed (regular, flat, or otherwise), under stairs, next to walls or buildings, or in any other location that will not allow for adequate cooling of the generator and/or the muffler. DO NOT contain generators during operation.

⚠ DANGER
Asphyxiation hazard. Place the generator in a well-ventilated area. DO NOT place the generator near vents or intakes where exhaust fumes could be drawn into occupied or confined spaces. Carefully consider wind and air currents when positioning the generator.

GROUNDING

⚠ WARNING
Shock hazard. Failure to properly ground the generator can result in electric shock.

NOTICE
Only use grounded 3-prong extension cords, tools, and appliances, or double-insulated tools and appliances.

The generator neutral is floating. The generator ground terminal is connected to the frame of the generator, the metal non-current-carrying parts of the generator, and the ground terminals of each receptacle. The generator (stator winding) is isolated from the frame and from the AC receptacle ground pin. Electrical devices that require a grounded receptacle pin connection may not function properly.

If this generator will be used only with cord and plug equipment connected to the receptacles mounted on the generator, National Electric Code does not require that the unit be grounded. However, other methods of using the generator may require grounding to reduce the risk of shock or electrocution.

Before using the ground terminal, consult a qualified electrician, electrical inspector, or local agency having jurisdiction for local codes or ordinances that apply to the intended use of the generator.

HIGH ALTITUDE OPERATION

Engine power is reduced the higher you operate above sea level. Output will be reduced approximately 3.5% for every 1000 feet of increased altitude from sea level.

High altitude adjustment is required for operation at altitudes over 5,000 ft. (1524 m). Operation without this adjustment will cause decreased performance, increased fuel consumption, and increased emissions.

NOTICE
DO NOT operate the generator at altitudes below 2,000 ft. (762 m) with the high altitude kit installed. Engine damage may occur.

High Altitude Carburetor Kit	Part# 202801
-------------------------------------	---------------------

OPERATION

BREAK-IN PERIOD

For proper break-in, do not exceed 50% of the rated running watts (900 watts) during the first five hours of operation.

Vary the load occasionally to allow stator windings to heat and cool and help seat the piston rings.

BEFORE STARTING THE GENERATOR

Verify that:

- The generator is placed in a safe, appropriate location.
- The generator is on a dry, flat, and level surface.
- The engine is filled with oil.
- Gasoline is in the fuel tank.
- All loads are disconnected.
- The ECO switch is in the OFF position.

⚠ DANGER

Fire and explosion hazard. DO NOT move or tip the generator during operation.

STARTING THE ENGINE

1. Turn the fuel cap vent to the ON position.

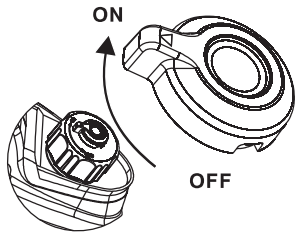

2. Turn the fuel knob to the choke position.

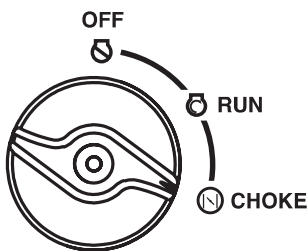

Note: The generator can be started from the Run position if warm from operation.

3. Firmly grasp and pull the recoil handle slowly until you feel increased resistance, then pull rapidly.

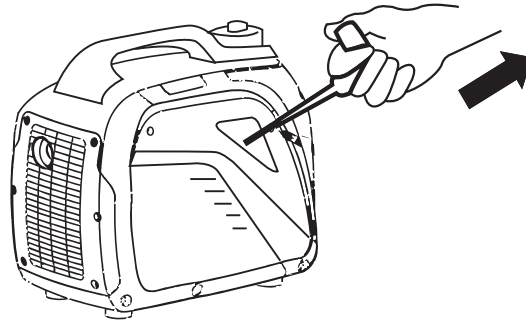

4. After the engine starts, turn the fuel knob to the RUN position.

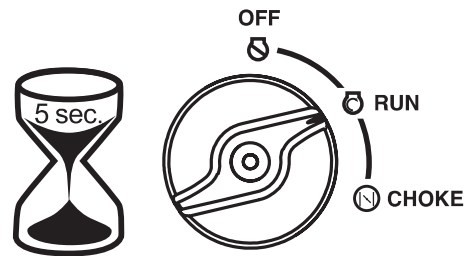

STOPPING THE ENGINE

1. Turn off and unplug all connected electrical loads.

IMPORTANT: Never start or stop the generator with electrical devices connected.

2. Let the generator run with no load for several minutes to stabilize internal temperatures of the engine and generator.

3. Turn the fuel knob to the OFF position.

4. Allow the engine to cool, then turn the fuel cap vent to the OFF position.

Note: If there is an emergency and the inverter must be stopped quickly, immediately move the fuel switch to the OFF position.

FREQUENCY OF USE

If the generator will be used on an infrequent or intermittent basis (more than one month before next use), refer to the Storage sections of this manual for information regarding battery charging and fuel deterioration.

ECO MODE

NOTICE

Always start the generator with ECO MODE OFF. Allow the engine speed to stabilize and the OUTPUT READY LED to illuminate before switching ECO MODE ON.

ECO MODE
COMBUSTIBLE EFICIENTE
COMMUTATEUR D'ÉCONOMIE

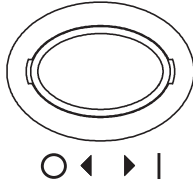

Note: Do not use ECO MODE when in parallel operation with another Westinghouse generator.

ECO MODE minimizes fuel consumption and noise by adjusting the engine RPM to the minimum required for the current load.

Turn ECO MODE ON when powering small appliances with continuous loads such as a computer or electric light.

Turn ECO MODE OFF when powering large surge loads such as an air conditioner or electric pump.

To turn on ECO MODE, verify that the OUTPUT READY LED is illuminated green, then push the switch to the ON position. If no load is present, the generator RPM will drop to idle speed. The generator will detect loads as they are applied and increase engine RPM.

To run the generator at maximum power and RPM, push the ECO MODE switch to the OFF position.

AC CIRCUIT BREAKER

The circuit breaker will automatically switch OFF if there is a short circuit, a significant overload of the generator at the receptacle, or if the combined load exceeds 15 Amps.

If the AC circuit breaker switches OFF automatically, check that the appliance is working correctly and it does not exceed the rated load capacity of the circuit before resetting the circuit breaker.

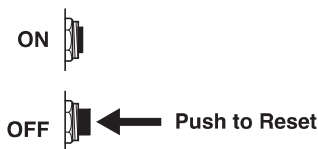

OVERLOAD RESET

The generator will automatically switch OFF all AC output to protect the generator if overloaded or if there is a short circuit in a connected appliance. However, the engine will continue to run. Marginal overloading that temporarily illuminates the OVERLOAD LED may shorten the service life of the generator.

OVERLOAD on the control panel will illuminate red and the green OUTPUT READY will be OFF.

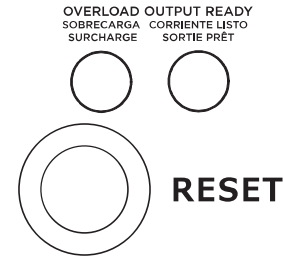

To restore AC output:

1. Turn off and unplug all connected electrical loads.
2. Push the RESET button on the control panel until the OVERLOAD LED goes OFF and the OUTPUT READY LED is illuminated.
3. Reset the circuit breaker if OFF.
4. Verify that the intended running and surge loads do not exceed the generator's capacity.
5. Reconnect electrical loads sequentially, allowing the generator to stabilize after each load is connected.

GENERATOR CAPACITY

NOTICE

Do not overload the generator's capacity. Exceeding the generator's wattage/ampere capacity can damage the generator and/or electrical devices connected to it.

Make sure the generator can supply enough continuous (running) and surge (starting) watts for the items you will power at the same time.

The total power requirements (Volts x Amps = Watts) of all appliances connected must be considered. Appliance and power tool manufacturers usually list rating information near the model or serial number.

To determine power requirements:

1. Select the items you will power at the same time.
2. Total the continuous (running) watts of these items. This is the amount of power the generator must produce to keep the items running. See the wattage reference chart on the next page.
3. Estimate how many surge (starting) watts you will need.

OPERATION

Surge wattage is the short burst of power needed to start electric motor-driven tools or appliances such as a circular saw or refrigerator. Because not all motors start at the same time, total surge watts can be estimated by adding only the item(s) with the highest additional surge watts to the total rated watts from step 2.

Example:

Tool or Appliance	Running Watts*	Starting Watts*
TV (Tube Type)	300	0
RV Refrigerator	180	600
Radio	200	0
Light (75 Watts)	300	0
Coffee Maker	600	0
	1580 Total Running Watts*	600 Highest Starting Watts*
	Total Running Watts	1580
	Highest Starting Watts	+ 600
	Total Starting Watts Needed	2180

*Wattages listed are approximate. Verify actual wattage.

POWER MANAGEMENT

To prolong the life of the generator and attached devices, use care when adding electrical loads to the generator. There should be nothing connected to the generator outlets before starting the engine. The correct and safe way to manage generator power is to sequentially add loads as follows:

1. With nothing connected to the generator, start the engine as described in this manual.
2. Plug in and turn on the first load, preferably the largest load you have.
3. Permit the generator output to stabilize (engine runs smoothly and attached device operates properly).
4. Plug in and turn on the next load.
5. Again, permit the generator to stabilize.
6. Repeat steps 4 and 5 for each additional load.

WATTAGE REFERENCE

Tool or Appliance	Estimated Running Watts*	Estimated Starting Watts*
Incandescent Lights (4 Quantity x 75 Watts)	300	0
TV (Tube Type)	300	0

Tool or Appliance	Estimated Running Watts*	Estimated Starting Watts*
Sump Pump (1/3 hp)	800	1300
Refrigerator or Freezer	700	2200
Well Pump (1/3 hp)	1000	2000
Radio	200	0
Drill (3/8", 4 amps)	440	600
Circular Saw (Heavy Duty, 7-1/4")	1400	2300
Miter Saw (10")	1800	1800
Table Saw (10")	2000	2000

*Wattages listed are approximate. Verify actual wattage.

EXTENSION CORDS

⚠ WARNING

Asphyxiation hazard. Extension cords running directly into the home increase the risk of carbon monoxide poisoning through any openings. If an extension cord running directly into your home is used to power indoor items, there is a risk of carbon monoxide poisoning to people inside the home. Always use battery-powered carbon monoxide detector (s) that meet current UL 2034 safety standards when running the generator. Regularly check the detector (s) battery.

⚠ WARNING

Asphyxiation hazard. When operating the generator with extension cords, make sure the generator is located in an open, outdoor area, at least 20 ft. (6 m.) from occupied spaces with exhaust pointed away.

⚠ WARNING

Fire and electrocution hazard. Never use worn or damaged extension cords. Damaged or overloaded extension cords could overheat, arc, and burn resulting in death or serious injury.

Before connecting an AC appliance or power cord to the generator:

- Use grounded 3-prong extension cords, tools, and appliances, or double-insulated tools and appliances.
- Make sure the tool or appliance is in good working order. Faulty appliances or power cords can create a potential for electric shock.
- Make sure the electrical rating of the tool or appliance does not exceed the rated power of the generator or the receptacle being used.

OPERATION

EXTENSION CORD SIZING

Only use grounded 3-prong extension cords marked for outdoor use that are rated for the electrical load.

Total Amperage	Minimum Gauge, Outdoor Rated	
	Up to 50 FT (15 M)	Up to 100 FT (30 M)
Up to 10A	12	8
Up to 15A	10	8
Up to 20A	10	6
Up to 30A	8	6
Up to 35A	6	6

PARALLEL OPERATION

⚠ WARNING

Fire and electrocution hazard. Never connect or disconnect the parallel cord leads when a generator is running.

⚠ CAUTION

Correct connection of the left and right cables is very important when the generators are used with a transfer switch to supply power to a building. To avoid serious personal injury or damage to electrical devices, including the generators, do not try to power an electrical system in a building without using an approved transfer switch.

NOTICE

Connecting to a generator that is not compatible can cause a low voltage output that can damage tools and appliances powered by the generator.

Parallel operation gives you the ability to link to a compatible Westinghouse Inverter Generator for combined running and peak power output.

A Westinghouse 507PC parallel cord (purchased separately) is required for parallel operation. This cord can be purchased from an authorized Westinghouse Generator dealer.

Note: Compatible Westinghouse generators without parallel ports can be operated in parallel with the receptacle-mounted parallel cable, Part# 260041.

NOTICE

DO NOT use ECO MODE during parallel operation if powering large surge loads such as an air conditioner or electric pump. Engine rpm may not adjust quickly enough to provide the voltage requirements of large surge loads, causing damage to the devices or the generators.

1. On both generators, make sure the engine/fuel knob and the ECO MODE switch are in the OFF position.
2. Connect two parallel cable leads to the parallel outlets on the first generator, then connect the opposite cable leads to the other generator's parallel outlets.

Note: If powering devices directly from the generators (not connected to a building's transfer switch), you do not need to match the left/right cables to the generator's parallel outlets.

3. Start one of the generators and wait until the OUTPUT READY LED illuminates.
4. Start the second generator and wait until the OUTPUT READY LED illuminates before connecting a load.
5. Connect additional loads as described in Power Management section.
6. Unplug all loads before stopping the generators.

TRANSPORTING

- Allow the generator to cool a minimum of 30 minutes before transporting.
- Replace all protective covers on the generator control panel.
- Only use the generator's fixed handle to lift the unit or attach any load restraints such as ropes or tie-down straps. **DO NOT** attempt to lift or secure the generator by holding onto any of its other components.
- Keep the unit level during transport to minimize the possibility of fuel leakage or, if possible, drain the fuel or run the engine until the fuel tank is empty before transport.

⚠ CAUTION

Fire hazard. Do not up-end the generator or place it on its side. Fuel or oil can leak and damage to the generator may occur.

MAINTENANCE

MAINTENANCE

▲ WARNING

Accidental start-up. Disconnect the spark plug boot from the spark plug when performing maintenance on the generator.

MAINTENANCE SCHEDULE

Regular maintenance will improve performance and extend the service life of the generator. Follow the hourly or calendar intervals, whichever occurs first. More frequent service is required when operating in adverse conditions as noted below.

Before Each Use
Check engine oil
After First 25 Hours or First Month
Change engine oil
After 50 Hours or Every 6 Months
Change engine oil ¹ Clean air filter ²
After 100 Hours or Every 6 Months
Inspect/clean spark arrestor Inspect/clean spark plug Inspect/adjust valve clearance ³
After 300 Hours or Every Year
Replace spark plug Replace air filter

¹ Change oil every month when operating under heavy load or in high temperatures.

² Clean more often under dirty or dusty conditions. Replace air filter if it cannot be adequately cleaned.

³ Recommend service to be performed by authorized Westinghouse service dealer.

MAINTENANCE REPLACEMENT PARTS

Description	Part Number
Air filter	202901
Spark arrestor	6789
Spark plug	97101
Muffler	203704

ENGINE SERVICE COVER

Remove the engine service cover to access the air filter, carburetor, oil fill / drain, and dipstick. Remove the two cover screws, then gently remove the cover with both hands to avoid damaging the cover eyelet posts.

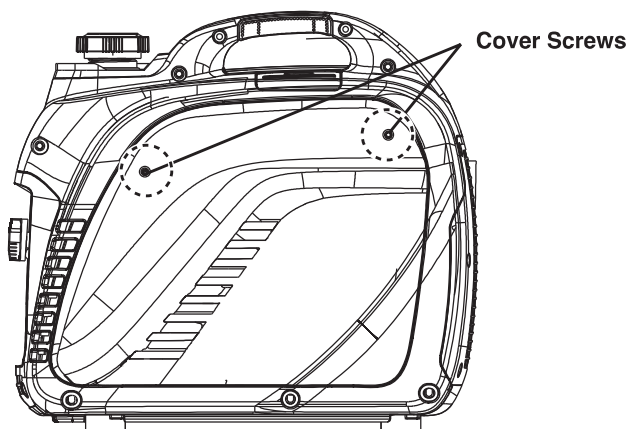

AIR FILTER MAINTENANCE

▲ WARNING

Fire hazard. Never use gasoline or other flammable solvents to clean the air filter. Use only household detergent soap to clean the air filter.

The air filter must be cleaned after every 50 hours of use or six months (frequency should be increased if the generator is operated in a dusty environment).

1. Place the generator on a level surface and allow the engine to cool for several minutes.
2. Remove the engine service cover.
3. Remove the screw securing the air cleaner cover. Tip the cover down to remove.

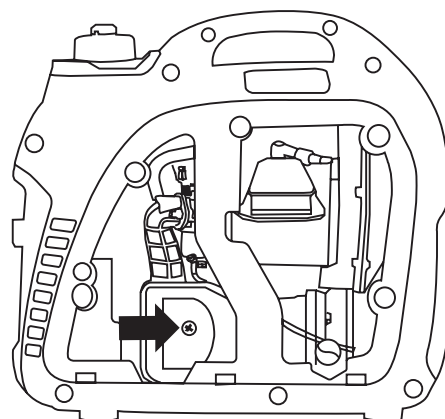

Note: The air filter element is oil soaked. Use an appropriate cleaning container.

NOTICE

Avoid skin contact with engine oil. Wear protective clothing and equipment. Wash all exposed skin with soap and water.

4. Remove the foam air filter from the air cleaner housing and wash it by submerging the element in a solution

MAINTENANCE

of household detergent soap and warm water. Slowly squeeze the foam to thoroughly clean.

NOTICE

DO NOT twist or tear the foam air filter element during cleaning or drying. Only apply slow but firm squeezing action.

5. Rinse the air filter element by submerging it in fresh water and applying a slow squeezing action. Allow the filter to dry thoroughly.

NOTICE

Do not pollute. Follow the guidelines of the EPA or other governmental agencies for proper disposal of hazardous materials. Consult local authorities or reclamation facility.

6. Dip the foam air filter in clean engine oil then squeeze out all excess oil. The engine will smoke when started if too much oil is left in the filter.
7. Install the foam air filter in the housing and reinstall the air cleaner cover.
8. Install the engine service panel.

Air Filter: 202901

ENGINE OIL LEVEL CHECK

⚠ CAUTION

Avoid skin contact with engine oil. Wear protective clothing and equipment. Wash all exposed skin with soap and water.

NOTICE

Always use the specified engine oil. Failure to use the specified engine oil can cause accelerated wear and/or shorten the life of the engine.

When using the generator under extreme, dirty, dusty conditions or in extremely hot weather, change the oil more frequently.

Ambient air temperature will affect engine oil performance. Change the type of engine oil used based on weather conditions.

Recommended Engine Oil Type								
		10W-30						
	5W-30					10W-40		
	5W-30 Synthetic							
°F	-20	0	20	40	60	80	100	120
°C	-28.9	-17.8	-6.7	4.4	15.6	26.7	37.8	48.9
Ambient temperature								

Check the engine oil level before each use or every 8 hours of operation.

1. Place the generator on a level surface and allow the engine to cool for several minutes.
2. Remove the engine service cover.
3. With a damp rag, clean around the oil dipstick.
4. Remove the oil dipstick and wipe the dipstick clean.

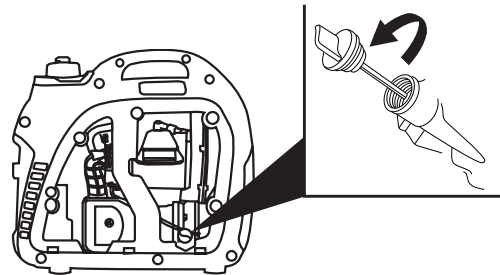

5. Screw the dipstick fully into the filler neck. Remove the dipstick and verify that the oil level is within safe operating range.

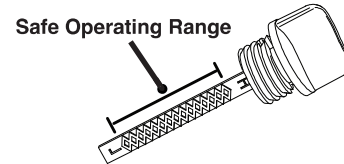

6. If low, add recommended engine oil incrementally and recheck until the level is between the L and H marks on the dipstick. DO NOT overfill. If over the full mark on dipstick, drain the oil to reduce oil level to the full mark on dipstick.
7. Replace the oil dipstick and hand-tighten.
8. Install the engine service cover.

ENGINE OIL CHANGE

When using the generator under extreme, dirty, dusty conditions or in extremely hot weather, change the oil more frequently. Change the oil while the engine is still warm from operation.

1. Place the generator on a level surface and allow the engine to cool for several minutes.

Note: Placing the generator on a raised surface slightly above the oil pan will facilitate draining.

2. Remove the engine service cover and spark plug cover. Disconnect the spark plug wire from the spark plug and place the wire where it cannot contact the spark plug.
3. With a damp rag, clean around the oil dipstick. Remove the dipstick and wipe clean.

MAINTENANCE

- Place an oil pan (or suitable container) under the oil fill/drain hole.
- Tilt the generator to drain the oil.

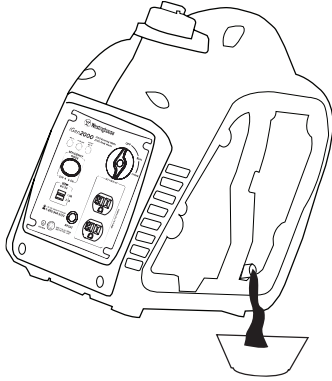

- Slowly pour oil into the oil fill opening until the level is between the L and H marks on the dipstick. Stop frequently to check the oil level. **DO NOT** overfill.

Maximum oil capacity: 0.37 US qt (350 ml)

- Replace the dipstick and hand-tighten.
- Connect the spark plug wire and install the engine service cover.

NOTICE

Do not pollute. Follow the guidelines of the EPA or other governmental agencies for proper disposal of hazardous materials. Consult local authorities or reclamation facility.

SPARK PLUG MAINTENANCE

Inspect and clean the spark plug after every 100 hours of use or six months. Replace the spark plug after 300 hours of use or every year.

NOTICE

ALWAYS use the Westinghouse OEM or compatible non-resistor-type spark plug. Use of resistor-type spark plug can result in rough idling, misfire, or may prevent the engine from starting.

- Place the generator on a level surface and allow the engine to cool.
- Remove the spark plug cover on top of the generator.
- Remove the spark plug boot by firmly pulling the spark plug boot directly away from the engine.
- Clean the area around the spark plug.
- Remove the spark plug with the included spark plug socket wrench.

NOTICE

Never apply any side load or move the spark plug laterally when removing the spark plug.

- Inspect the spark plug. Replace if electrodes are pitted, burned, or the insulator is cracked. Only use a recommended replacement plug.
- Measure the spark plug electrode gap with a wire-type feeler gauge. If necessary, correct the gap by carefully bending the side electrode.

Spark plug gap: 0.024 - 0.032 in. (0.60 - 0.80 mm)

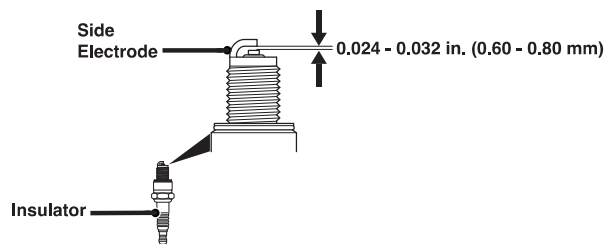

- Carefully install the spark plug finger tight, then tighten as additional 3/8 to 1/2 turn with the spark plug wrench.
- Install the spark plug boot and engine service cover.

SPARK ARRESTOR SERVICE

Check and clean the spark arrester after every 100 hours of use or six months. Failure to clean the spark arrester will result in degraded engine performance.

- Place the generator on a level surface and allow the muffler to cool before servicing the spark arrester.
- Remove the cover screws and the muffler cover. Use a screw driver to remove the spark arrester.

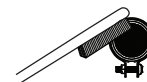
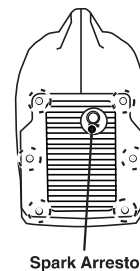

- Carefully remove the carbon deposits from the spark arrester screen with a wire brush. The spark arrester must be free of breaks and tears. Replace the spark arrester if damaged.
- Reinstall the spark arrester and muffler cover.

MAINTENANCE

STORAGE

Proper storage preparation is required for trouble-free operation and generator longevity.

NOTICE

Gasoline stored for as little as 30 days can deteriorate, causing gum, varnish, and corrosive buildup in fuel lines, fuel passages and the engine. This corrosive buildup restricts the flow of fuel, which can prevent the engine from starting after a prolonged storage period. The use of fuel stabilizer significantly increases the storage life of gasoline. Full-time use of fuel stabilizer is recommended. Follow the manufacturer's instructions for use.

STORAGE TIME	RECOMMENDED PROCEDURE
Less than 1 month	No service required.
2 to 6 months	Fill with fresh gasoline and add gasoline stabilizer. Drain the carburetor float bowl.
6 months or longer	Drain the fuel tank and carburetor float bowl.

SHORT TERM STORAGE

- Allow the generator to cool a minimum of 30 minutes before storage.
- Replace all protective covers on the generator control panel.
- Wipe the generator with a moist cloth. Clean any debris from the air inlets on the front of the unit and muffler cooling vents.
- Store the generator in a well-ventilated, dry location away from sparks, open flames, pilot lights, heat, and other sources of ignition such as areas with a spark-producing electric motor or where power tools are operated.
- Do not store the generator or gasoline near furnaces, water heaters, or any other appliances that produce heat or have automatic ignitions.
- With the engine and exhaust system cool and all surfaces dry, cover the generator to keep out dust. Do not use a plastic sheet as a dust cover. Non-porous materials trap moisture and promote rust and corrosion.

LONG TERM STORAGE

Even properly stabilized fuel can leave residue and cause corrosion if left long term. If storing the generator for two to six months, drain the float bowl to prevent gum and varnish buildup in the carburetor.

DRAINING THE FLOAT BOWL

1. Remove the engine service cover.
2. Locate the drain hose extending from the bottom of the carburetor float bowl.

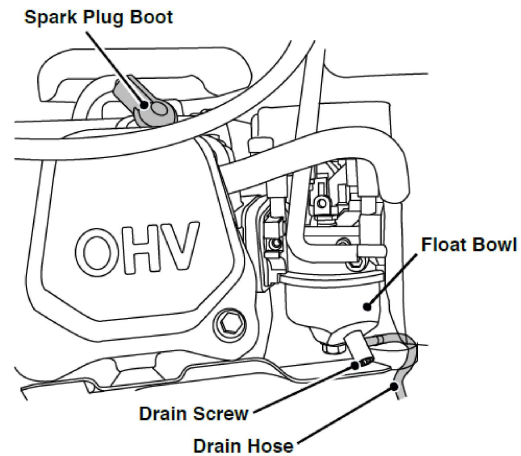

3. Place the loose end of the hose outside the generator into an approved gasoline container to catch the drained fuel.
4. Loosen the float bowl drain screw and allow the fuel to drain. Tighten the float bowl drain screw.
5. Route the drain hose between the air cleaner housing and the engine service cover. Install the engine service cover.

DRAINING THE FUEL TANK

If storing the generator for longer than six months, drain the fuel tank to prevent fuel separation, deterioration, and deposits in the fuel system.

1. Unscrew the fuel tank cap. Remove the fuel screen filter.
2. Using a commercially available gasoline hand pump (not included), siphon the gasoline from the fuel tank into an approved gasoline container. DO NOT use an electric pump.
3. Reinstall the fuel screen filter and the fuel tank cap.
4. Start the generator and allow it to run until the generator engine stops.
5. Remove the spark plug.
6. Put a teaspoon of engine oil into the cylinder and pull the recoil handle until resistance is felt. At this position the piston is coming up on its compression stroke and both valves are closed. Storing the engine in this position will help prevent internal corrosion. Return the recoil handle gently.
7. Reinstall the spark plug. Leave the spark plug boot disconnected to prevent accidental starting.
8. Install the engine service cover.

MAINTENANCE

VALVE CLEARANCE

NOTICE

Checking and adjusting valve clearance must be done when the engine is cold.

1. Remove the rocker arm cover and carefully remove the gasket. If the gasket is torn or damaged, it must be replaced.
2. Remove the spark plug so the engine can be rotated more easily.
3. Rotate the engine to top dead center (TDC) by pulling the recoil handle slowly. Looking through the spark plug hole, the piston should be at the top (both valves are closed).
4. Both the rocker arms should be loose at TDC on the compression stroke. If they are not, rotate the engine 360°.
5. Insert a feeler gauge between the rocker arm and the valve stem to measure valve clearance.

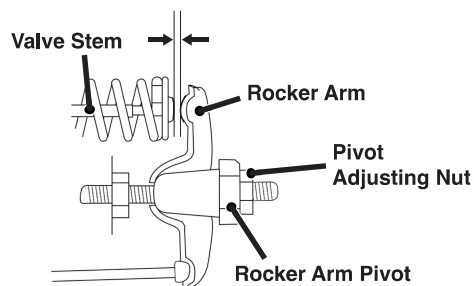

	Intake Valve	Exhaust Valve
Valve Clearance	0.0031 – 0.0047 in (0.08 – 0.12 mm)	0.0051 – 0.0067 in (0.13 – 0.17 mm)
Torque	8-12 N·m	8-12 N·m

6. If an adjustment is necessary, hold the rocker arm pivot and loosen the pivot adjusting nut.
7. Turn the rocker arm pivot to obtain the specified clearance. Hold the rocker arm pivot and re-tighten the pivot adjusting nut to the specified torque.

Torque: 106 inch-pound (12 N·m)

8. Perform this procedure for the other valve.
9. Install the gasket, rocker arm cover, and spark plug.

TROUBLESHOOTING

TROUBLESHOOTING

TROUBLESHOOTING

PROBLEM	POSSIBLE CAUSE	CORRECTION
Engine will not start	Out of fuel.	Refuel.
	Bad fuel, generator stored without treating or draining gasoline, or refueled with bad gasoline.	Drain the fuel tank. Refuel with fresh gasoline.
	Dirty air filter.	Clean the air filter.
	Low engine oil level stopped generator.	If low oil LED illuminated, turn battery switch to the OFF position. Add engine oil.
	Spark plug wet with fuel (flooded engine).	Wait five minutes. Turn battery switch to the OFF position. Pull recoil handle rapidly several times. If the generator does not start, remove spark plug and dry.
	Spark plug faulty, fouled, or improperly gapped.	Gap or replace the spark plug. Reinstall.
	Fuel system malfunction, fuel pump failure, ignition malfunction, valves stuck, etc.	Contact Westinghouse customer service toll-free at 1 (855) 944-3571.
	CO sensor removed or modified.	Return to original configuration.
	CO sensor activated or system fault occurred.	Relocate generator / Contact Westinghouse customer service toll-free at 1 (855) 944-3571.
Engine starts, then shuts down	Out of fuel.	Refuel.
	Incorrect engine oil level.	Check engine oil level.
	Dirty air filter.	Clean the air filter.
	Contaminated fuel.	Drain the fuel tank. Refuel with fresh gasoline.
	Defective low oil level switch.	Contact Westinghouse customer service toll-free at 1 (855) 944-3571.
Engine lacks power	Air filter restricted.	Clean or replace air filter.
	Bad fuel, generator stored without treating or draining gasoline, or refueled with bad gasoline.	Drain the fuel tank. Refuel with fresh gasoline.
	Fuel system malfunction, fuel pump failure, ignition malfunction, valves stuck, etc.	Contact Westinghouse customer service toll-free at 1 (855) 944-3571.
Engine runs rough or bogs when load applied	Dirty air filter.	Clean the air filter.
	Generator overloaded.	Unplug some devices.
	Faulty power tool or appliance.	Replace or repair tool or appliance. Stop and restart the engine.
	Fuel system malfunction, fuel pump failure, ignition malfunction, valves stuck, etc.	Contact Westinghouse customer service toll-free at 1 (855) 944-3571.
No power at AC receptacles	OUTPUT READY LED is OFF and OVERLOAD LED is ON.	Check AC load. Stop and restart engine. Check the air inlet. Stop and restart the engine.
	AC circuit breaker/s tripped.	Check AC loads and reset circuit breaker/s.
	Faulty power tool or appliance.	Replace or repair tool or appliance. Stop and restart the engine.
	Faulty generator.	Contact Westinghouse customer service toll-free at 1 (855) 944-3571.

EXPLODED VIEW

EXPLODED VIEW AND ENGINE PARTS LISTS

EXPLODED VIEW A

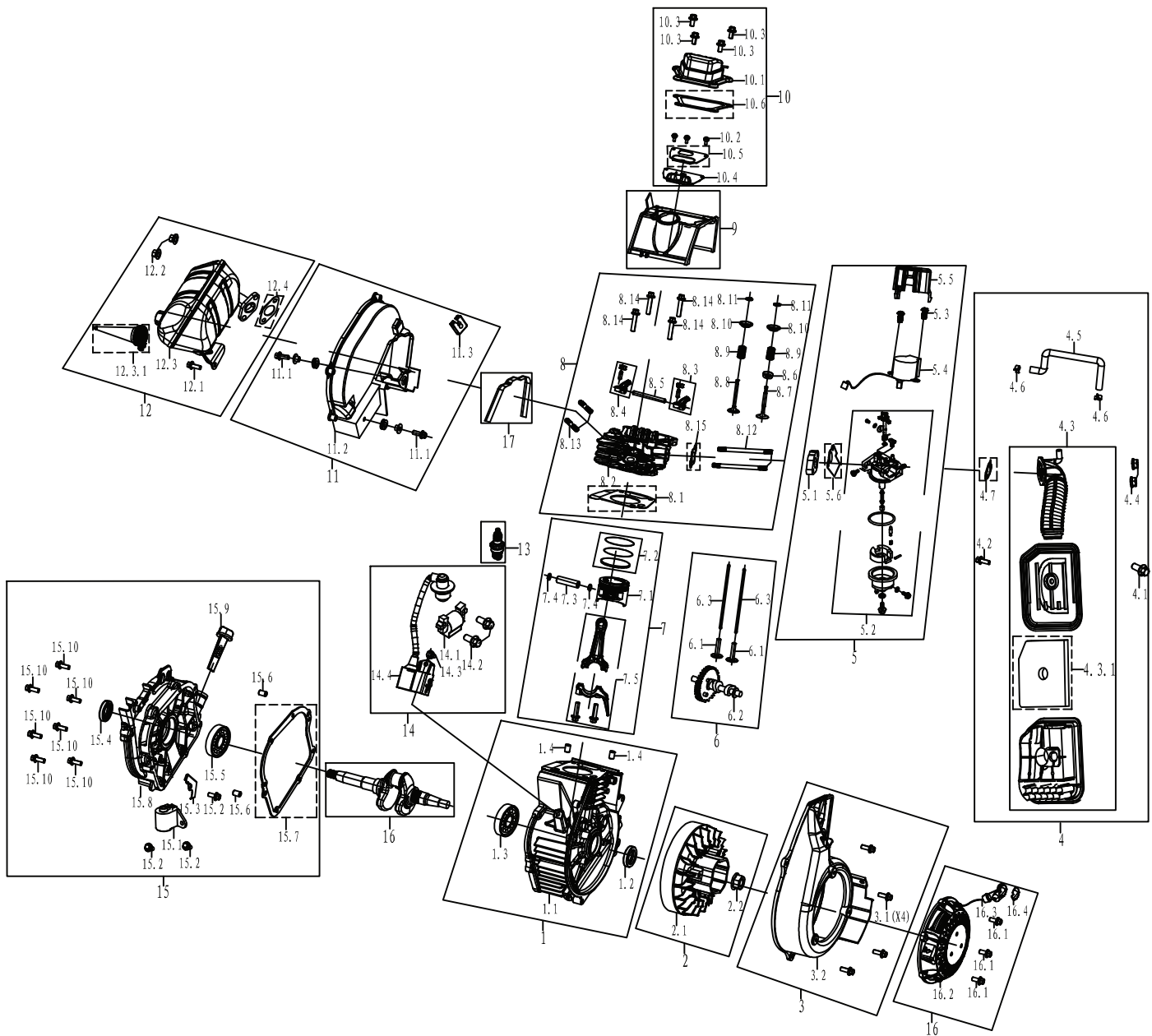

EXPLODED VIEW

EXPLODED VIEW A

NO.	PART #	DESCRIPTION
1		CRANKCASE ASSEMBLY
1.1	200204	CRANKCASE
1.2	93501	CRANKCASE OIL SEAL
1.3	93008	BEARING
1.4	240904	CRANKCASE LOCATING PIN
2		FLYWHEEL ASSEMBLY
2.1	200401	FLYWHEEL ASSEMBLY
2.2	90014	NUT M12
3		BLOWER HOUSING ASSEMBLY
3.1	91329	BOLT M6X16
3.2	2079	BLOWER HOUSING
4		AIR FILTER ASSEMBLY
4.1	91330	BOLT M6X20
4.2	91329	BOLT M6X16
4.3	202901	AIR FILTER ASSEMBLY
4.3.1	5291	AIR FILTER ELEMENT
4.4	90016	NUT M6
4.5	95614	BLAST PIPE
4.6	94407	FUEL HOSE CLIP
4.7	96009	AIR FILTER GASKET
5		CARBURETOR ASSEMBLY
5.1	202301	CARBURETOR CONNECTION BLOCK
5.2	202801	CARBURETOR ASSEMBLY
5.3	92239	BOLT M3X8
5.4	752007	STEPPER MOTOR
5.5	209906	STEPPER MOTOR PROTECTIVE COVER
5.6	96121	CARBURETOR PAPER PAD
6		ALTERNATOR ASSEMBLY
6.1	206101	VALVE LIFTER
6.2	202001	CAMSHAFT ASSEMBLY
6.3	201901	PUSH ROD
7		PISTON & PISTON RING ASSEMBLY
7.1	201201	PISTON
7.2	201601	PISTON RING ASSEMBLY
7.3	205501	PISTON PIN
7.4	201301	PISTON PIN RING
7.5	201503	CONNECTING ROD ASSEMBLY
8		CYLINDER HEAD ASSEMBLY
8.1	96005	CYLINDER HEAD GASKET
8.2	201001	CYLINDER HEAD
8.3	202101	INLET ROCKER ARM ASSEMBLY
8.4	202102	EXHAUST ROCKER ARM ASSEMBLY
8.5	202103	ROCKER ARM SHAFT
8.6	201802	AIR INLET SPRING LOWER SEAT
8.7	201701	INTAKE VALVE
8.8	205901	EXHAUST VALVE
8.9	206001	VALVE SPRING
8.10	201801	INTAKE VALVE SPRING SEAT

NO.	PART #	DESCRIPTION
8.11	200801	VALVE LOCK CLIP
8.12	91023	DOUBLE END BOLT M6X92
8.13	91002	DOUBLE END BOLT M6X32
8.14	91339	BOLT M6X50
8.15	96007	JOINT BLOCK GASKET
9		WIND-LEAD-COVER
10		CYLINDER HEAD COVER ASSEMBLY
10.1	201101	CYLINDER HEAD COVER
10.2	91805	CROSS GROOVED DISC HEAD BOLT M3X8
10.3	91329	BOLT M6X16
10.4	201103	CYLINDER HEAD BREATHING PLATE
10.5	201104	BREATHING BOARD GASKET
10.6	96006	CYLINDER HEAD COVER SEAL WASHER
11		MUFFLER COVER ASSEMBLY
11.1	91330	BOLT M6X20
11.2	202502	MUFFLER OUTER COVER
11.3	209902	COVER TRAINING CARD
12	50240024	MUFFLER ASSEMBLY
12.1	91325	BOLT M6X12
12.2	90016	NUT M6
12.3	203704	MUFFLER
12.3.1	6789	SPARK ARRESTER
12.4	96008	EXHAUST SEAL WASHER
13	97101	SPARK PLUG
14		IGNITER ASSEMBLY
14.1	97502	MAGNETO IGNITER
14.2	91330	BOLT M6X20
14.3	91329	BOLT M6X16
14.4	97501	IGNITER ASSEMBLY
15		CRANKCASE COVER ASSEMBLY
15.1	205101	OIL SENSOR
15.2	91325	BOLT M6X12
15.3	209903	WIRE CLIP
15.4	93501	CRANKCASE OIL SEAL
15.5	93008	BEARING
15.6	240904	CRANKCASE LOCATING PIN
15.7	96004	CRANKCASE SEAL WASHER
15.8	200101	CRANKCASE COVER
15.9	205601-160	DIPSTICK
15.10	91330	BOLT M6X20
16		START PULLER ASSEMBLY
16.1	91325	BOLT M6X12
16.2	5323	START PULLER
16.3	500018	HANDLE
16.4	500017-231	HANDLE COVER
16	200301	CRANKSHAFT
17	209901	SEALED RUBBER

EXPLODED VIEW

EXPLODED VIEW B

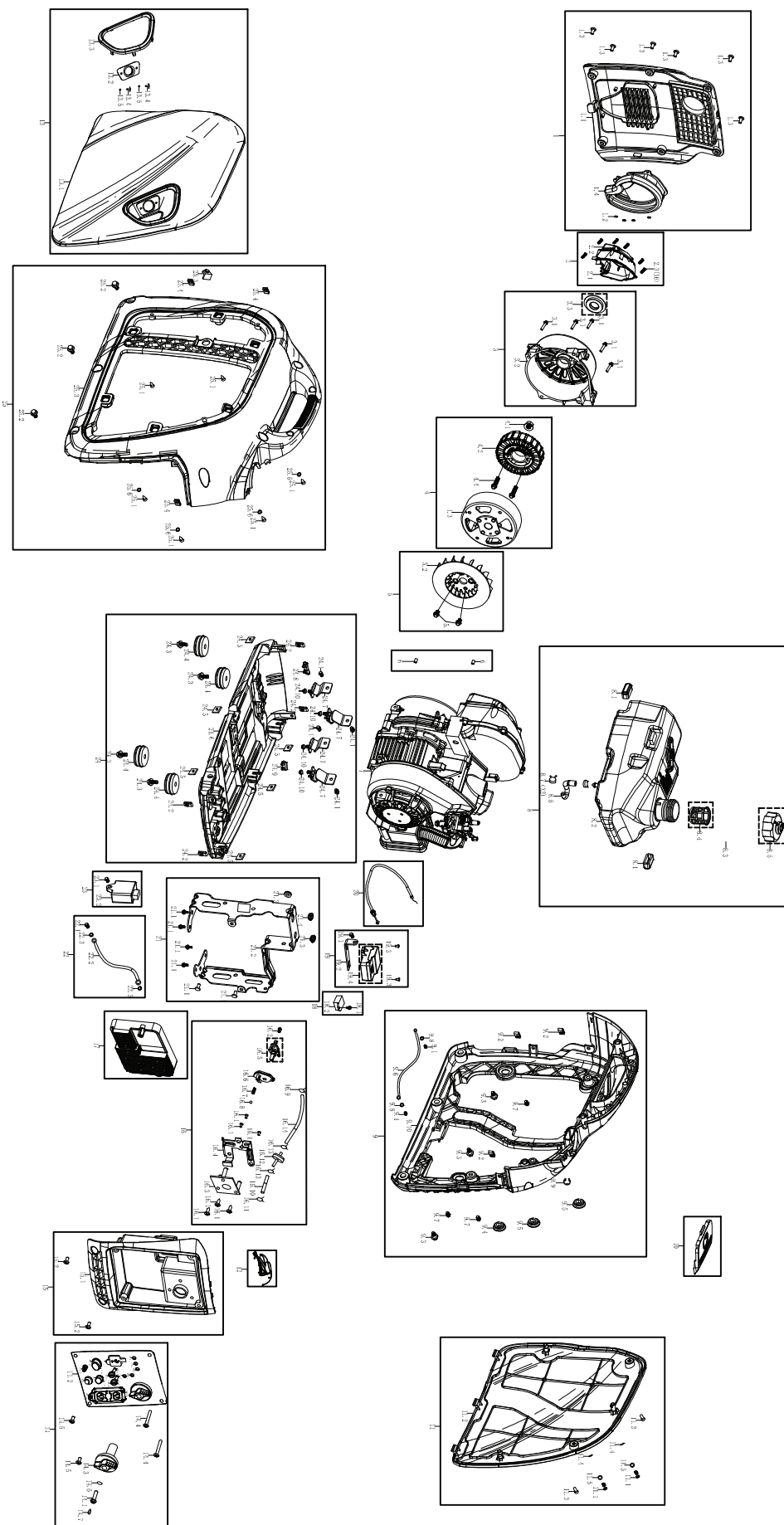

EXPLODED VIEW

EXPLODED VIEW B

NO.	PART #	DESCRIPTION
1		MUFFLER COVER ASSEMBLY
1.1	500384	MUFFLER COVER
1.2	99519	FLAT WASHER
1.3	91825	CROSS RECESSED PAN HEAD SCREW + GASKET COMBINATION M5
1.4	500038	ALTERNATOR AIR INLET HOUSING
2		MUFFLER COVER ASSEMBLY
2.1	202501	MUFFLER OUTER COVER
2.2	202601	MUFFLER OUTER COVER SEALING RUBBER
2.3	92108	SELF-TAPPING SCREW ST4.8
3		ALTERNATOR FIXED COVER ASSEMBLY
3.1	91334	BOLT M6
3.2	500036	ALTERNATOR FIXING COVER
3.3	500039	AIR INLET HOUSING COVER
4		ROTOR & STATOR KIT ASSEMBLY
4.1	90014	NUT M12
4.2	504506	ALTERNATOR STATOR ASSEMBLY
4.3	752008	ALTERNATOR ROTOR ASSEMBLY
4.4	91334	BOLT M6
5		ALTERNATOR FAN ASSEMBLY
5.1	91325	BOLT M6
5.2	500037	ALTERNATOR FAN
6		CRANKCASE LOCATING PIN
7		ENGINE ASSEMBLY DH80
8		FUEL TANK ASSEMBLY
8.1	500009	FUEL TANK ISOLATION RUBBER PAD C
8.2	700210L	FUEL TANK
8.3	500032	FUEL SLOT
8.4	500010	FILTER
8.5	500304	FUEL TANK CAP
8.6	95431L	FUEL PIPE
8.7	94411	FUEL PIPE CLIP
9		RIGHT FRAME ASSEMBLY
9.1	91325	BOLT M6
9.2	500045	LOCK CLIP M5
9.3	92003	SCREW M6
9.4	500008	FUEL TANK ISOLATION RUBBER PAD B
9.5	500007	FUEL TANK ISOLATION RUBBER PAD A
9.6	500044	SHORT CIRCUITING WIRE
9.7	91825	CROSS RECESSED PAN HEAD SCREW + GASKET COMBINATION M5
9.8	94003	TOOTH WASHER
9.9	94006	SPLIT WASHER

NO.	PART #	DESCRIPTION
9.10	500029-221	RIGHT FRAME
10	500031-221	OBSERVATION COVER
11		RIGHT PANE ASSEMBLY
11.1	92012	STOP BOLT M5
11.2	500297-221E	RIGHT COVER
11.3	91825	CROSS RECESSED PAN HEAD SCREW + GASKET COMBINATION M5
11.4	94018	SPLIT WASHER
11.5	94219	FLAT WASHER
12	504507	DEPUTY WIRING HARNESS
13		LEFT PANEL ASSEMBLY
13.1	500296-221E	LEFT PANEL
13.2	500019-052	PULL ROPE GUIDE PLATE
13.3	500298	HANDLE DECORATION BLOCK
13.4	92001	OPEN TYPE OVAL HEAD BLIND RIVETS
13.5	94217	FLAT WASHER
14		CONTROL PANEL ASSEMBLY
14.1	92032	SCREW M4
14.2	504501	CONTROL PANEL
14.2.1	9236	OIL WARMING LIGHT
14.2.2	9236	FAULT WARMING LIGHT
14.2.3	9243	RUNNING LIGHTS
14.2.4	9236	CO WARNING LIGHT
14.2.5	9236	CO WARNING LIGHT
14.2.6	9229	USB
14.2.7	503108	USB DUST COVER
14.2.8	6032	L5-20R RECEPTACLE
14.2.9	9194	DUST COVER
14.2.10	9232	PARALLEL PORTS
14.2.11	9122	DUST COVER
14.2.12	9244-15	THERMAL PROTECTOR
14.2.13	6404	DUST COVER
14.2.14	9230	RESET BUTTON
14.2.15	9237	ECO SWITCH
14.2.16	9080	WATERPROOF CAP
14.2.17	D2000I-31089-A	GROUNDING BOLT
14.3	500016	KNOB
14.4	92013	CROSS RECESSED PAN HEAD SCREW + GASKET COMBINATION M5
14.5	91825	CROSS RECESSED PAN HEAD SCREW + GASKET COMBINATION M5
14.6	94325	FLAT WASHER
14.7	500456	PLUG
15		CONTROL PANEL ASSEMBLY
15.1	504453	PANEL BACK COVER

EXPLODED VIEW

EXPLODED VIEW B

NO.	PART #	DESCRIPTION
15.2	91825	CROSS RECESSED PAN HEAD SCREW + GASKET COMBINATION M5
16		OIL SWITCH ASSEMBLY
16.1	92014	SCREW ST4.2
16.2	91325	BOLT M6
16.3	500011	OIL SWITCH HOLDER
16.4	504380	FUEL SWITCH BRAKE
16.5	503062	FUEL SWITCH
16.6	500015	CABLE TRAY
16.7	500012	SPRING
16.8	500003	STEEL BALL
16.9	94411	FUEL LINE CLAMP
16.10	95430L	FUEL LINE
16.11	94423	FUEL LINE CLAMP
16.12	516401	FILTER
16.13	94408	FUEL LINE CLAMP
16.14	95470L	FUEL PIPE
17	500818	INVERTER MODULE
18		DC VOLTAGE REGULATOR ASSEMBLY
18.1	91325	BOLT M6
18.2	500043	DC VOLTAGE REGULATOR
19	100450002	CO MODULE KIT ASSEMBLY
19.1	91325	BOLT M6
19.2	504503	CO MODULE BRACKET
19.3	92328	BOLT M4
19.4	599070	CO MODULE
20	504476	CABLE
21		INVERTER BRACKET ASSEMBLY
21.1	91325	BOLT M6
21.2	504534	INVERTER BRACKET
21.3	500008	FUEL TANK ISOLATION RUBBER PAD B
21.4	500007	FUEL TANK ISOLATION RUBBER PAD A
22		GROUNDING WIRE ASSEMBLY
22.1	91325	BOLT M6
22.2	500026	GROUNDING WIRE
22.3	94003	TOOTH WASHER
23		CO FLAME OUT ACTUATOR ASSEMBLY
23.1	91325	BOLT M6
23.2	599065	CO FLAME OUT ACTUATOR
24		BASEBOARD ASSEMBLY
24.1	91325	BOLT M6
24.2	500045	LOCK CLIP M5
24.3	91330	BOLT M6
24.4	500034	FRAME ISOLATION RUBBER PAD
24.5	90027	NUT M6

NO.	PART #	DESCRIPTION
24.6	500002	BOTTOM PLATE
24.7	500317	SHOCK ABSORBER
24.8	500040	ALTERNATOR ISOLATION PAD
24.9	500035	ENGINE ISOLATION PAD
24.10	90016	NUT M6
25		LEFT FRAME ASSEMBLY
25.1	92014	SCREW ST4
25.2	92003	SCREW M6
25.3	500028-221	LEFT FRAME
25.4	500045	LOCK CLIP M5
25.5	500027	LIMIT BLOCK
25.6	99519	FLAT WASHER
26	99012	SPARK PLUG WRENCH
27	500942	FUNNEL
28	99628	OIL BOTTLE
29	99506	SCREWDRIVER

SCHEMATICS

SCHEMATIC

SCHEMATIC

