



# MIG200GDsv



**Operator's Manual**




**LINLONG LIMITED**  
[www.weldpro.com](http://www.weldpro.com)

## Introduction

This manual contains the description of the hardware and the operating instructions of the equipment. For your safety and that of others, please read this manual carefully.

## Attention

Pay attention to the words following the signs below.

Sign	Description
 <b>DANGER</b>	The word following this sign means that there is great potential danger, which may cause a major accident, damage or even death, if the instructions are not followed.
 <b>WARNING</b>	The word following this sign means that there is some potential danger, which may cause bodily injury or property damage, if the instructions are not followed.
 <b>ATTENTION</b>	The word following this sign means that there is potential risk, which may cause malfunctions and/or breakdowns, if the instructions are not followed.

## Edition

The contents of this manual are updated regularly in order to include all product updates. The manual is to be used solely as a user's guide, except where indicated otherwise. No warranties of any kind, whether expressed or implied are made in relation to the information, descriptions, suggestions or any other content of the manual.

The images of this manual are for reference only. If there is any inconsistency between the image and the actual product, the actual product will govern.

# CONTENTS









1 SAFETY WARNING.....	4
2 PRODUCT DESCRIPTION.....	8
3 TWO YEAR WARRANTY.....	9
4 TECHNICAL PARAMETERS.....	10
5 INSTRUCTIONS FOR THE INSTALLATION.....	11
6 FRONT PANEL CONTROLS.....	16
7 RECOMMENDED OPERATING PARAMETERS.....	21
8 EXPLODED VIEW AND LIST OF MAJOR COMPONENTS.....	24
9 POTENTIAL OPERATING PROBLEMS.....	27
10 MAINTENANCE.....	27
11 TROUBLESHOOTING.....	28
12 INITIAL PROBLEM DETECTION.....	29

# SAFETY WARNING

The safety notes contained in this manual are to ensure the correct use of the machinery and to prevent injury to the user or other persons.

The welding machine was designed and manufactured with safety in mind. Please refer to the safety warning contained in the manual to avoid accidents.

The incorrect use of the equipment may cause different injuries, as described below. Please read the user manual carefully to avoid these kind of injuries.

Sign	Description
	<ul style="list-style-type: none"> <li>Any contact with the electric parts may cause fatal electric shock or burns.</li> </ul>
	<ul style="list-style-type: none"> <li>The gases and fumes are harmful to health.</li> <li>Operation in confined spaces may cause simple asphyxiation.</li> </ul>
	<ul style="list-style-type: none"> <li>Sparks and hot workpieces after welding may cause fire.</li> <li>Incorrectly connected cables may cause fire.</li> <li>The incomplete connection of the workpiece side circuit may cause fire.</li> <li>Never weld in the presence of tinder, as it may cause explosion.</li> <li>Never weld airtight containers such as valves, pipes etc., as they may break.</li> </ul>
	<ul style="list-style-type: none"> <li>The arc ray may cause eye inflammation and / or skin burns.</li> <li>Sparks and residue may cause eye and skin burns.</li> </ul>
	<ul style="list-style-type: none"> <li>Toppling the gas cylinder may cause physical injuries.</li> <li>The misuse of gas cylinders may lead to high-pressure gas leakage and may cause personal injuries.</li> </ul>
	<ul style="list-style-type: none"> <li>Keep fingers, hair, clothes etc. away from moving parts, such as the fan.</li> </ul>
	<ul style="list-style-type: none"> <li>Wire shooting out of the welding torch may stab your eyes, face or other exposed body parts.</li> </ul>
	<ul style="list-style-type: none"> <li>Never stand in front of or under the suspension hook, as it may fail and cause personal injuries.</li> </ul>



## **This procedure must be carried out by an electrician**

Connect the power supply cable to the switch box taking in account the voltage of the current entering (see the table of the technical parameters). Do not connect the machine if the voltage is inadequate and ensure that the difference of the power supply is within the permitted range.



### **DANGER Please observe the following rules to avoid serious accidents**

- Never use the equipment for purposes other than welding.
- Follow related regulations regarding the characteristics of the power source, choice of place, usage of high-pressure gas, storage, configuration, safe-keeping of the workpiece after welding and disposal of waste, etc.
- Non-essential personnel shall not enter the welding area.
- Persons using pacemaker are not allowed near the welding machine or welding area without doctor's permission. The magnetism created by energizing the welding machine may have a negative effect on the pacemaker.
- The installation, operation, inspection and maintenance of the equipment must be carried out by authorized personnel.
- For your safety, you must understand the contents of the user's manual.



### **DANGER Please observe the following rules to avoid electric shock**

- Keep away from any electrical parts.
- The machine and workpiece shall be grounded by authorized personnel.
- Cut off the power before installation or inspection, and restart it 5 minutes after finishing that activity. The capacitor is a rechargeable device. Please ensure it has no voltage before starting again even if the power source is cut off.
- Never use wire with inadequate wire gauge, damaged insulation sleeve or exposed conductor.
- Do ensure the proper isolation of wire connections.
- Never use the device when the enclosure is removed.
- Never use broken or wet insulation gloves.
- Welding screens must be used when working in overhead position.
- Check and maintain the equipment regularly. Do not use the equipment until the faulty parts are fixed.
- Turn off the power when not in use.
- Follow the related national and local standards and regulations when using the AC welding machine in confined spaces or overhead position.



### **DANGER Please observe the following instructions to avoid fire, explosions, etc.**

- Remove combustible materials from the welding area.
- Keep away from any combustible materials while welding.
- After welding, keep the hot workpiece away from flammable gases.
- Remove all combustible materials when welding in a patio, on the ground or on a wall.
- The work lead of the base metal should be as close to the welding place as possible.
- Never weld installations with gas pipes or airtight valves.
- Keep a fire extinguisher close to the welding area to prevent fire.



**WARNING** The gases and fumes are hazardous to health, please wear personal protective equipment according to regulations

- Wear exhaust equipment and respiratory protective equipment to prevent gas poisoning or choke.
- Use suggested exhaust ventilation system and respiratory protective equipment to prevent injuries or poisoning by gas or dust.
- To prevent oxygen deficiency, air out the gas filled space full of CO<sub>2</sub> and argon on the bottom, when operating in trunks, boilers, cabins, etc.
- Request a supervisor's inspection when operating in confined spaces. Air the room and wear respiratory protective equipment.
- Never operate in degreasing, washing or spraying spaces.
- Use respiratory protective equipment while welding armored steel, as this produces poisonous dust and gases.



**WARNING** The welding arc, sparks, residues and noise are hazardous to health, please wear personal protective equipment

- Eye protection against welding arc is recommended when welding or supervising welding.
- Please wear safety goggles.
- Welder's gloves, welder's goggles, long sleeve clothes, leather apron, and other standard personal protective equipment must be worn during the welding operation.
- A screen to protect other people against the welding arc must be set in the welding area.



**WARNING** Please observe the following notes to avoid toppling or breaking the gas cylinder

- Use the gas cylinder correctly.
- Use the built-in or recommended gas regulator.
- Read the manual of the gas regulator carefully before using it, and pay attention to the safety notes.
- Secure the gas cylinder with appropriate holder and other related parts.
- Never expose the cylinder to high temperature or direct sunlight.
- Keep your face away from the gas cylinder's valve when opening it.
- Put on the cap when the cylinder is not in use.
- Never put the welding torch on the gas cylinder. The electrode must not touch the gas cylinder.



**WARNING** Any contact with the rotating parts will cause injury. Please note the following:

- Never use the machine when the enclosure is off.
- The installation, operation, inspection and maintenance of the equipment must be carried out by authorized personnel.
- Keep fingers, hair, clothes etc. away from moving parts, such as the fan.



**WARNING** The end of the wire may cause personal injuries. Please note the following:

- Never look into the conduction hole when checking if the wire feed is normal, as wire shooting out may stab your eyes and face.
- Keep your eyes, face or other uncovered body parts away from the end of the welding torch when feeding the wire manually or when pressing the switch.



**ATTENTION For better work efficiency and power source maintenance, please note the following:**

- Take precautions to prevent toppling.
- Never use welding equipment to unfreeze a pipe.
- Lift the power source from side when using a forklift to avoid toppling.
- When using the crane to lift, tie the rope to the ears with an angle smaller than 15° respect to the vertical direction.
- When lifting the welding machine equipped with gas cylinder and wire feeder, disconnect it from the power source and ensure that the machine is in horizontal position. Secure the gas cylinder with a belt or chain when moving it to avoid personal injuries.
- Ensure stability and insulation when lifting the wire feeder by the suspension hook for welding.



**ATTENTION Pay attention to electromagnetic interference**

- You may need to take extra preventive measures when the equipment is used in a particular location.
- Before installation, assess the potential issues with the electromagnetism in the welding environment as follows:
  - a) Proximity of upper and lower parts of the welding equipment to other nearby power cables, control cables, signal cables and phone cables.
  - b) Wireless radiation-emitting products such as devices emitting and receiving TV signals.
  - c) Computers and other control equipment.
  - d) Protection equipment, etc. equipment to supervise industrial equipment.
  - e) Health of personnel affected, such as personnel using pacemaker or audiphones.
  - f) Instruments for adjusting and measuring instruments.
  - g) Anti-disturb capability of other equipment used. Users should ensure the compatibility of the equipment with the environment, which may require extra preventive measures.
  - h) Practical conditions of the welding and other activities.
- Users should observe the following to decrease radiation interference.
  - a) Connect the welding equipment to the power supply lines by the power supply cable.
  - b) Maintain the welding equipment regularly.
  - c) The cables should be short enough to stay close to each other and to the ground.
  - d) Ensure the safety of all the metal parts to be welded and other parts nearby.
  - e) The workpiece should be properly grounded.
  - f) Shield or protect all other cables and equipment to minimize the effect of possible disturbances. In some special cases, the welding equipment may need to be completely shielded.
- Users are responsible for the interference due to welding.

# PRODUCT DESCRIPTION

---

This welding machine is equipped with the world's most advanced inverter technology.

The inverter's working principle is that the 60Hz power line frequency is transformed to direct current and inverted to a high frequency using a high power IGBT device. After that, a voltage drop is generated and it is transformed to a to high-current DC using the Pulse Width Modulation (PWM) technology. Using the power inverter technology, the volume and the weight is substantially reduced and the conversion efficiency is increased by 30%.

In addition to the MIG function, the machine has the STICK, TIG and Flux Core functions as well. It is equipped with a digital display panel, which allows simple, single-knob ("synergic") adjustments to the feeding speed, to the welding voltage and other welding parameters.

Using CO2 shielding gas, our welding machine is equipped with a unique electrical reactor, which can precisely control the short-circuit transfer and mixed transfer modes, this way it shows better performance than other machines. Compared with welding machines using silicone controlled rectifier and hot tapping, our products have the following advantages: stable wire feed rate, portable, energy saving, free of electromagnetic noise. Besides, our products spatter less, easier arc starting, deep welding pool, high duty cycle, etc.

This portable equipment has STICK, TIG and Flux Core functions which has the following advantages: high efficiency, power saving, etc. It is especially suitable for private users who wish to work with different metals using different techniques.

Thank you for choosing our product. Please feel free to share your valuable suggestions with us; we are continuously working on improving our products and services.



## WARNING

**The machine is mainly used for industrial purposes. It causes radio interference when used indoor. Users must take preventative measures.**

# TWO YEAR WARRANTY

WELDPRO Warranty and Return Terms  
Welders and Plasma Cutters

All Weldpro welders and plasma cutters are covered under the following specific terms of warranty. All welders and plasma cutters are warranted to the original purchaser only, when purchased through an authorized seller of Weldpro products for a period of two (2) years from the date of purchase, to be free of manufacturers defect or failure. Proof of purchase and date of purchase paperwork will be required by Weldpro at the time of the claim.

Extended warranty coverage may be available for Weldpro welders and plasma cutters at an additional cost. Always check with Weldpro.

The Weldpro warranty is limited to defects, malfunctions or failure of the equipment to operate properly based specifically and solely from manufacturer defects. Any malfunctions from improper use, lack of maintenance, incorrect or insufficient source supply power to the units, shipping damage, and similar failures not related to specific manufacturers defect will not be honored.

Weldpro will not be responsible in the event of a product failure, for lost time in operation or use of said product. Rather it will honor solely the product itself only.

Further, the warranty will cover the repair or replacement of the unit in question for the term of the warranty with either a new or a refurbished unit, or in some cases replacement parts of the same model, at the discretion of Weldpro. As a term of the Weldpro warranty, if and when applicable, individual parts are needed, they may be supplied to the customer rather than replacing the entire unit. Situations like this may include, but are not limited to items such as foot pedals, torches, mig wire rollers, feed spools, or any other item Weldpro deems more practical to supply individually.

Weldpro will provide free shipping return of the damaged product due to manufacturers defect for the first 30 days of the warranty term if shipping is within the lower 48 United States. Customers outside this area must check with Weldpro for further shipping instructions. Failures after the initial 30-day period, and due to manufacturers defect, may not enjoy free return shipping.

If it is determined when the product is returned to Weldpro that there is no malfunction, or that the assumed malfunction by the customer was user error, Weldpro may request a shipping fee refund prior to the return of the item to the customer.

Prior to returning any item thought to be malfunctioning or damaged due to manufacturers defect, customers are required to contact Weldpro first, to explain the failure and to obtain a Return Merchandise Authorization number, or the item may not be covered under the terms of this warranty.

Weldpro ships in the USA from third party shippers such as, but not limited to UPS, FedEx, and the USPS. Weldpro is not responsible for damage that occurs during shipping. It is the customer's responsibility to check the item at the time of delivery. If a customer receives an item damaged, they must immediately contact both Weldpro and the shipper to document and report the damage as soon as possible, and in no circumstances later than 48 hours after delivery. All shipping and delivery dates are tracked for arrival. Weldpro may require photo image of the damage at their discretion.

Returned items within the first 30 days. Undamaged items in good working condition may be returned within the first 30 days of purchase. In such a case, these items are not eligible for the free return shipping policy associated with items that have manufacturers defects. A restocking fee will be charged for said return of up to 25% on any item returned with a valid RMA number that are undamaged and not covered or subject under the terms of this warranty. The amount of the restocking fee is solely at the discretion of Weldpro and based on the condition of the returned item and its accessory parts and packaging. Further, should Weldpro receive an item in good working condition that has sustained physical damage, Weldpro has the right to refuse acceptance of said returned item completely, and the customer will be responsible for return shipping of the product to them.

Weldpro does not imply or suggest any interpretation of the above warranty beyond what is stated in this print of its terms.

Weldpro is not responsible for injury due to improper use of the equipment or failure to heed all of the safety precautions associated with the dangers of welding or cutting metals.

The terms and conditions of the Weldpro warranty are subject to change without notice. Be sure to check the terms of the Weldpro warranty prior to your purchase.

# TECHNICAL PARAMETERS

Model	MIG200GDsv	
Parameters		
Supply voltage (V)	1 phase 115V±15%	1 phase 230V±15%
Frequency (Hz)	60	
Rated input current (A)	35.7 (MIG) 44.3 (MMA) 26.4 (TIG)	35.7 (MIG) 41.7 (MMA) 26.8 (TIG)
No-load voltage (V)	65	
Output current (A)	40-120 (MIG) 40-120 (MMA) 15-120 (TIG)	40-200 (MIG) 40-200 (MMA) 15-200 (TIG)
Output voltage (V)	16-20 (MIG) 21.6-24.8 (MMA) 10.6-14.8 (TIG)	16-24 (MIG) 21.6-28 (MMA) 10.6-18 (TIG)
Duty cycle (%)	30%120A 100%66A	30%200A 100%110A
Power factor	≥0.73	
Efficiency (%)	≥80	
Wire speed (ft/min)	6.5-26.2	6.5-45.9
Post flow (s)	1	
Wire diameter (in)	.023/.030/.035/.040	
Appropriate thickness	22ga.-6ga.	
Housing protection class	Ip21	
Insulation class	F	
Cooling method	Fan-cooled	
Weight (lb)	54.7	
Dimensions (in)	25.2x12.8x23.8	



# INSTRUCTIONS FOR THE INSTALLATION

---

The welding machine is equipped with an input voltage compensation device. This device allows the machine to work without interruption when the input voltage fluctuates  $\pm 10\%$  with respect to the nominal voltage.

When using a long cable in order to reduce the voltage drop, a cable with heavier gauge wire area is suggested. If the cable is too long, this will affect the arc starting performance and other system functions, we suggest to use the recommended length.

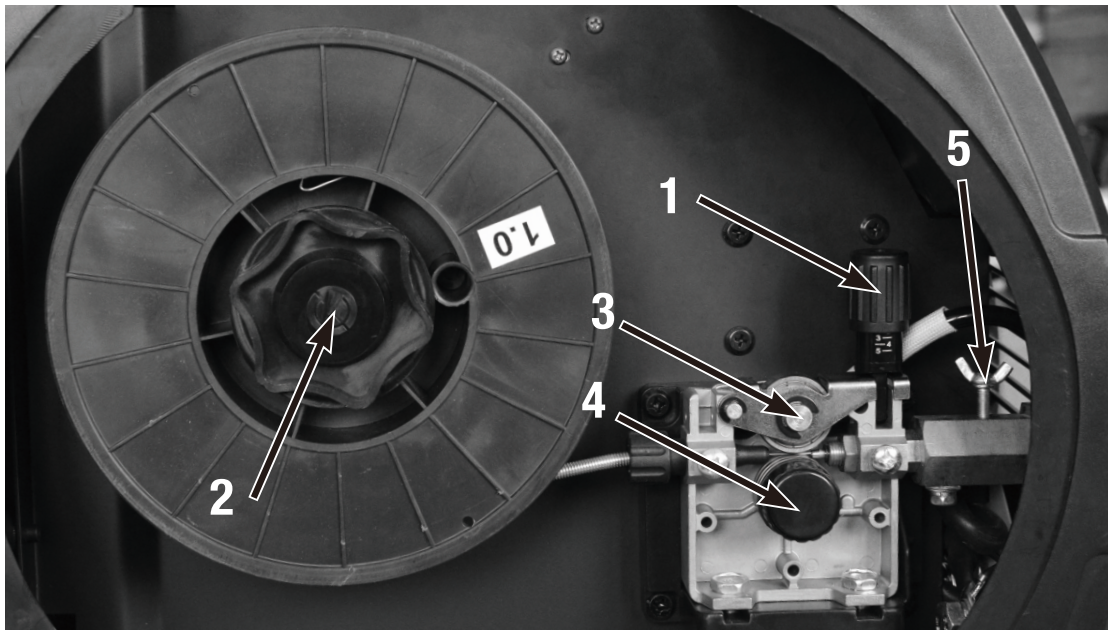
1. Ensure that the intake of the machine is not covered or blocked to avoid malfunction of the cooling system.
2. Use a ground cable with a cross sectional are of no less than 10AWG to connect the housing with the ground. To do so, connect the grounding interface to the back to the grounding device, or ensure that the grounding end of the power interface has been connected to ground securely and independently. For better security, both solutions can be used at the same time.

## MIG200GDsv installation process

### 1. MIG welder setup

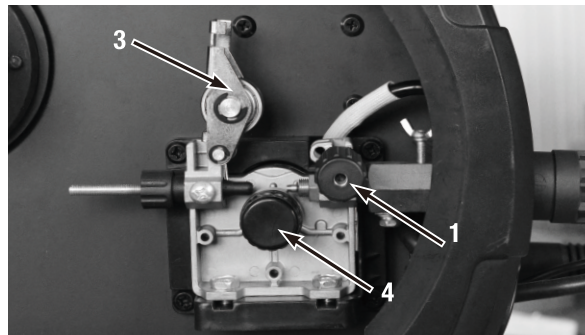
With MIG welding you must be sure to have your tank of shielding gas ready. (usually 25% CO<sub>2</sub> and 75% Argon) also known as "C25".

Open the side of your MIG200GDsv to expose the setup mechanism. Install the torch cable through the front of the machine and secure it using the provided wing nut (5) as shown in Figure 1 below.

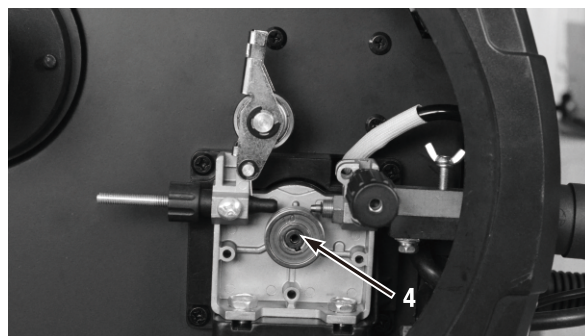


(Figure 1)

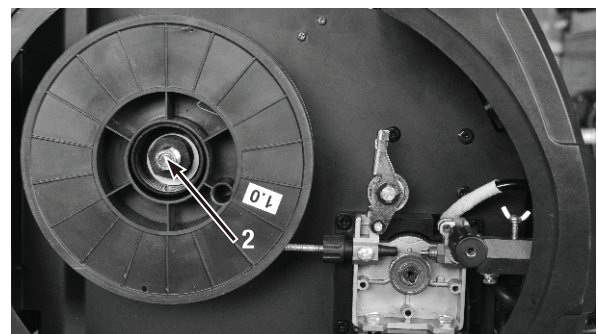
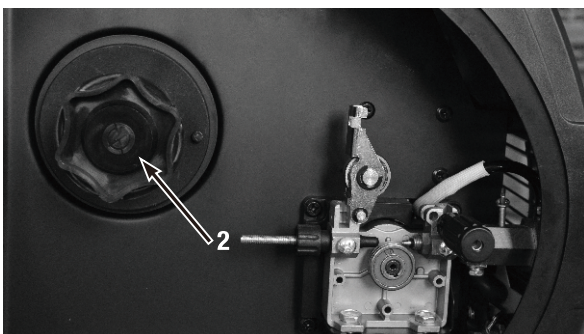
1. Roller tensioner. Loosen and tilt down the roller tensioner (1) toward you, then lift and flip the tensioner assembly (3) up.



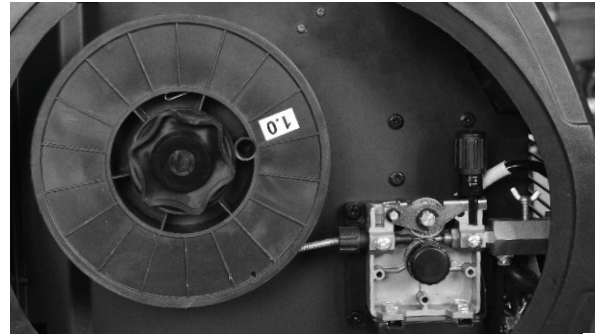
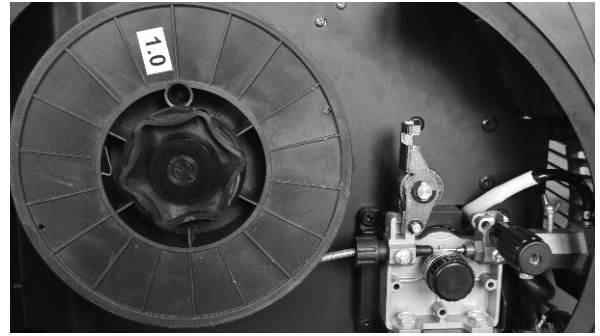
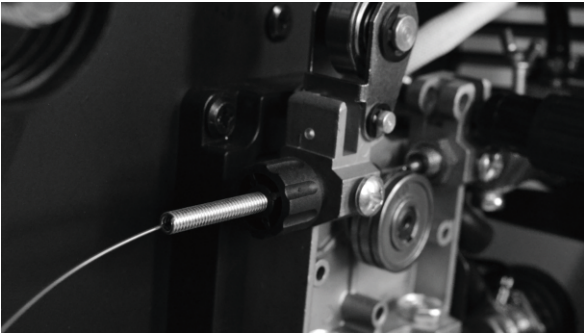
2. Twist the drive roller knob (4) counter clockwise to remove it. Slide out the lower drive wheel. The drive wheel will have markings on the front and back in two different sizes, in either millimeters or thousandths. A .06mm will handle 0.023 to 0.025 wire. Likewise a .08 will handle .030 wire. Be sure the correct size groove is in the inner position of the drive assembly to match the size of the wire you will be using and reinstall.



3. Remove the spool retainer nut (2) by turning it counter clockwise. Remove any plastic covering that may be on your new wire but do not un-secure the wire that is in the spool yet unless it interferes with the following test. If it does, just secure the loose wire end with painters tape or similar to the rest of the wire temporarily. Remember to use solid core wire for MIG welding. Now, simply place your wire spool on the idler roller with the wire set up to be fed from the bottom as seen in the photo. Before un-securing the wire, replace the spool retainer. Next roll the wire spool to be sure it turns freely, but has a slight drag.



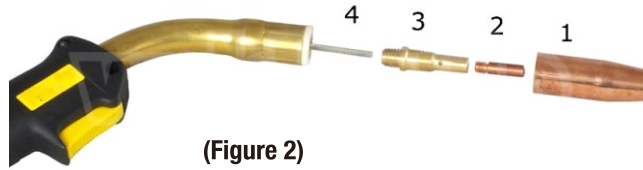




**Note :** a slight drag is necessary and should be adjusted correctly by the spool retainer. The tension is adjustable with the nut on the wire spool. The drag will prevent the wire from continuing to spin and unwind itself each time you release your torch trigger.

Once you are comfortable that there is a slight, even smooth drag on the welding wire spool, you may un-secure the wire from its shipping state. Be careful not to allow the wire to spin off the spool. The welding wire is under some tension, so hold it securely as you snip the bent end off and feed it through the spring opening on the top, over the drive wheel and into the torch cable. Feed it up into the cable a ways manually so it won't fall back out. Before releasing your grip on the wire, close the wheel tensioner (3) and replace the tension knob (1).

4. Connect your regulator to your CO<sub>2</sub>/Argon tank. Do not over tighten the regulator. They are made of brass and can be damaged. Once your regulator is connected to the shielding gas tank, open your gas tank slowly. If gas escapes from the regulator outlet, turn the knob on the regulator until it seals the gas from escaping. Once you have done that, open your gas tank valve all the way. This is an important step because the gas tank valve seals leakage at the full open valve, as well as the full closed valve position. Leaving the gas tank valve half open will risk losing gas unnecessarily.
5. Next, connect the supplied gas hose from the regulator outlet to the gas inlet on the backside of your MIG200GDsv welder. Snug tighten only, do not over tighten. Remove the components from the front of your MIG torch. Doing this will allow your MIG wire to feed through more easily as illustrated in Figure 2 below.
6. With your wheel drive tensioner (1) still untightened for final adjustment, turn on your welder. After giving it a change to warm up, press your torch trigger. Do not look into the torch. Wire may or may not feed since the tensioner is not yet final adjusted. If wire begins to feed, loosen slightly the wheel adjuster (1) to temporarily prevent wire from feeding, and adjust your gas flow to the welder by turning your regulator until flow is about 20 to 25 CFH (cubic feet per hour). Release the trigger.



(Figure 2)

Position your torch cable in a smooth wide sweeping position so you can reach the side of your welder while holding the torch in your hand and not kinking it. Now, with tensioner (1) still turned out to the loose tension, press and hold your trigger. **WARNING .. DO NOT LOOK INTO THE TORCH END!** Wire may or may not begin to feed. Turn up your wire feed knob on the front of the machine, and give the wire time to travel along the cable. Watch the wire at the roller to see it feed. Slowly tighten down the tension on the drive wheel tensioner (1) until wire begins to feed. No more tension than smooth feeding is needed or desired. Once it has fed out of the torch end, release the trigger. Slide the torch end parts back over the wire. Snip the wire approximately  $\frac{1}{4}$  inch to  $\frac{1}{2}$  inch from the nozzle end.

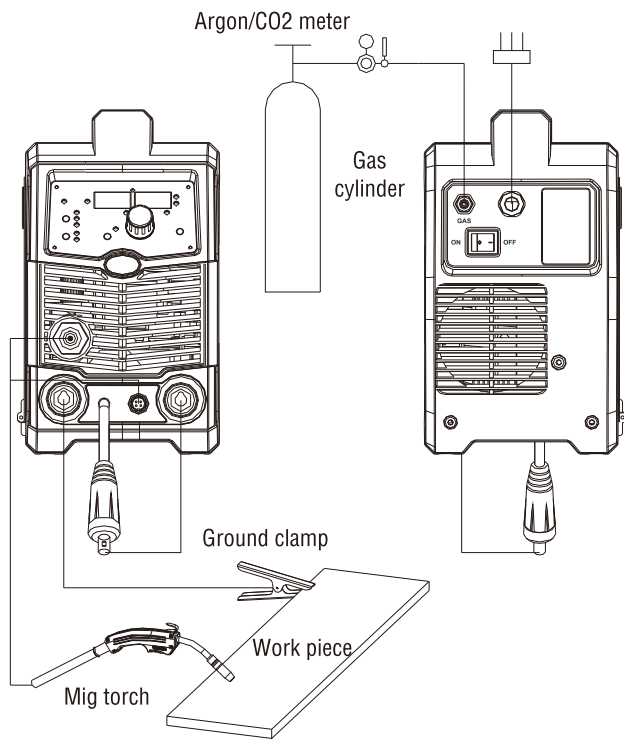
## 2. LIFT TIG welder setup

- 1) Connect the source of the shielding gas properly to your TIG Torch gas line. Be sure to use 100% Argon gas for TIG welding. You cannot use your argon/co2 mix that is used for MIG welding. The gas supply chain must include the gas cylinder, the pressure regulator flow meter of the argon, and the gas pipe. The fittings of the gas pipe must be fastened by hose clamps or other devices, to prevent the entry and exit of air.
- 2) Be sure to switch your welder to the TIG MODE on the front of the welder.
- 3) Connect the plug of the TIG welding torch to the "-" connection on the front panel, and tighten clockwise. Connect the plug of the TIG welding ground cable to the "+" connection of the front panel, and tighten clockwise. Connect the other end of the ground cable to the workpiece.
- 4) Before you begin TIG welding, and before you turn on your welder, grind your tungsten to a point, set your flow meter to approximately 20 to 25 CFH (cubic feet per hour) and be sure to turn on the gas valve on your TIG Torch Head. Lift Tig arc is started by touching the tungsten tip to your workpiece momentarily and then lifting it. Don't scratch, touch and lift.

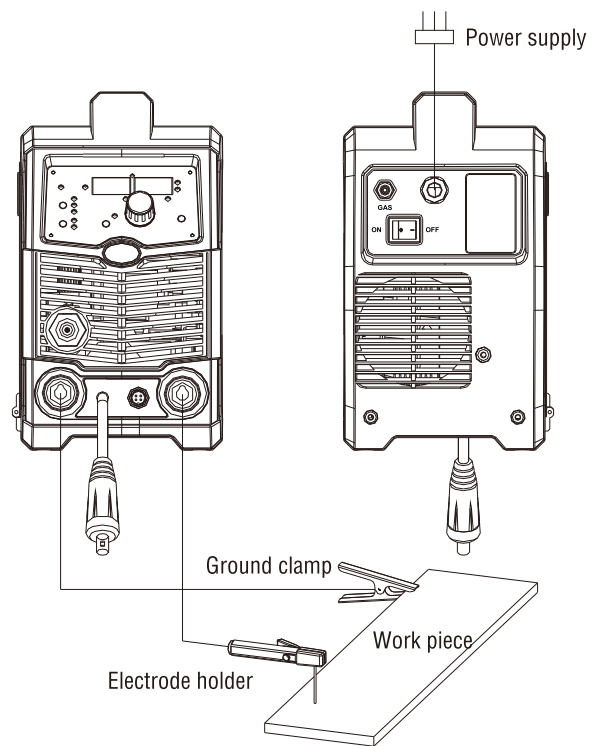
## 3. STICK welder setup

- 1) Ensure that the cord of the electrode holder and the cord of the ground (workpiece) are connected properly and snugged secure.
- 2) Pay attention to which dinse plug connector you use for the electrode holder and the ground clamp. DC welders can be connected two different ways. Electrode positive, the electrode holder is connected to the "+" terminal, and Electrode negative, the electrode holder is connected to the "-" terminal. While this is true, 99% of all stick welding is done with the electrode connected to the "+" terminal which is also known as DCEP (reverse polarity, electrode positive) This should be your choice for connection.
- 3) Be sure to switch the front of your welder to STICK MODE. Also, in MMA or "Stick" mode, select the menus button and an option for ARC force is available. Arc Force adjusts voltage up should the welding "rod" or "stick" get too close to the work. Doing this helps prevent the welding rod from sticking to the work.
- 4) Good choices for welding rod would be 7018, or for deep penetration / cleaning rod 6011. Do not use 6010 with this welder, it will not perform as nicely as the 6011.

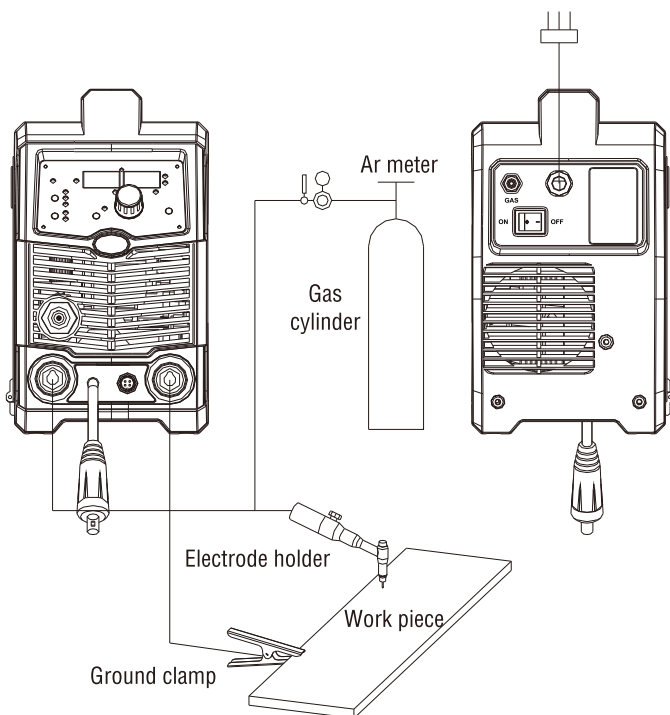
### Installation drawing for the MIG175/200GDsv (MIG)



### Installation drawing for the MIG200GDsv (STICK)



### Installation drawing for the MIG200GDsv (Lift TIG)



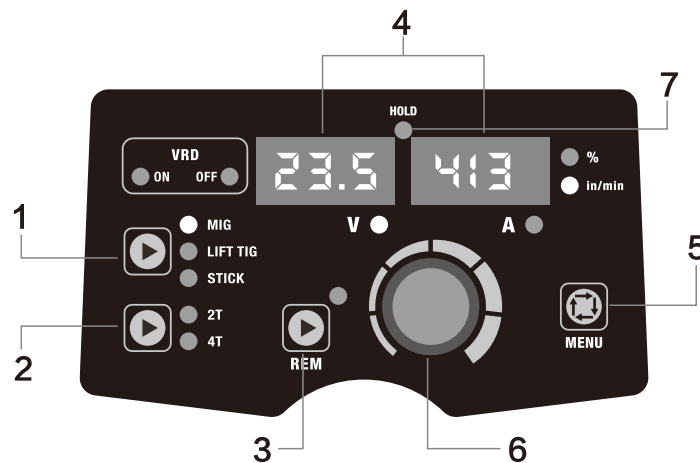
# FRONT PANEL CONTROLS

Your MIG200GDsv uses a synergic design adjustment system which automatically adjusts welding Voltage according to your wire speed setting. This is a feature that helps coordinate the two settings relative to each other.

On the front of your MIG200GDsv you will find a short cable protruding from the bottom center. This cable is the final connection to your welding torch in MIG and Flux Core modes. If you connect this cable to the (-) dinse connector you will have chosen DCEN or straight polarity. Conversely, if you connect this short cable to the (+) dinse connector, your torch will be set to DCEP or, reverse polarity. Choose DCEP for MIG welding and choose DCEN for Flux Core welding.

Also on the front panel you will find a small two terminal jack connector. This is simply for the on / off torch trigger.

In the MIG mode, the menu button on the front of the machine toggles through three additional settings. Voltage, Inductance, and wire Diameter sizes.



## Front panel components:

1. STICK/LIFT TIG/MIG switch
2. 2T/4T switch
3. MIG welding torch and spool gun switch (only in MIG mode)
4. Multifunctional display
5. MENU selection key (only in MIG and STICK mode)
6. Multifunctional adjustment knob (for coarse adjustment, press and turn the knob: wide adjustment range and fast adjustment; for fine adjustment, turn the knob without pressing is: small adjustment range, slow adjustment)
7. Data lock indicator light (as you stop welding, this indicator light comes up, and the multifunctional display shows the settings of the last welding work).

### **Polarity conversion dinse wire plug, for use with MIG or Flux Core Welding**

**This machine allows polarity conversion. For this reason, it has a positive and a negative outlet between the wire feeder and wire reel. When using solid wire with gas shielding, the welding torch must be connected to the positive output, and the ground cable must be connected to the negative output. When using flux cored wire, the two cables must be connected the other way around.**

## Operating instructions:

### 1) Start-up display

The [multifunctional display] blinks for 5 seconds as the machine starts up in welding mode.

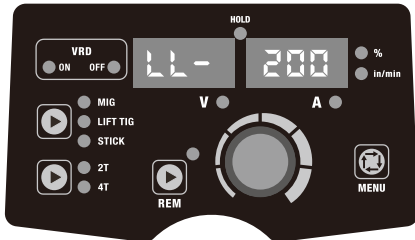


Image 1: Start-up display

### 2) Usage instructions STICK mode

1. With the welder on press the [STICK/LIFT TIG/MIG switch], the STICK mode indicator light comes up as the machine switches to STICK mode.
2. Activation and deactivation of the VRD function in STICK mode: change the current to 108A. Press and hold the [2T/4T switch] to activate or deactivate the VRD function. Image 2 shows the display panel with the activated VRD function, Image 3 shows it with deactivated VRD function.

**VRD:** It is the “Voltage Reduction Device” function that reduces unloaded open circuit voltage as a safety measure



Image 2: display default current value and with enabled VDR function



Image 3: display with default current value and disabled VDR function

3. The multifunctional display in “Image 5” shows the default value of the current: “80” in Amperes (A).
4. The [multifunctional adjustment knob] allows current adjustment during welding. The changes are shown on the [multifunctional display].
5. 3 seconds after the configuration of the welding parameters the [multifunctional display] blinks one time indicating that the data is saved. Further, the machine will show the same data the next time it’s started up, if the parameters are not modified.
6. Arc force current adjustment: press the [MENU selection key] until you reach the arc force current adjustment mode, then turn the [multifunctional adjustment knob] to set the arc force data. The adjustment range is 20-100% (Image 4).
7. Image 5 shows the data and figures in welding mode.

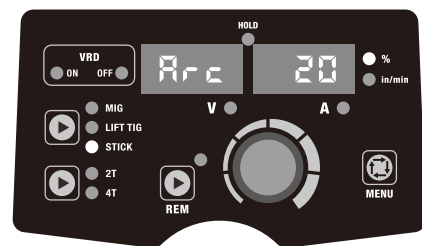


Image 4

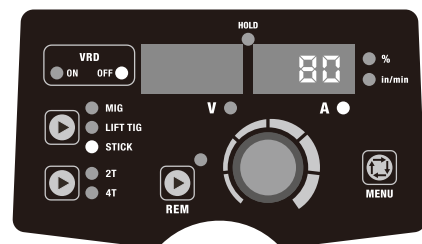


Image 5

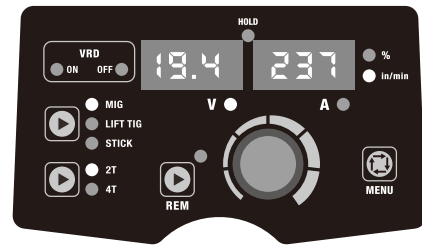
### 3) Usage instructions in LIFT TIG mode

1. With the welder on press the [STICK/LIFT TIG/MIG switch], the LIFT TIG mode indicator light comes up as the machine switches to LIFT TIG mode. LIFT TIG means that first the tungsten contacts the workpiece, and once the arc is started, the electrode is lifted.
2. Lift TIG mode (Image 6).



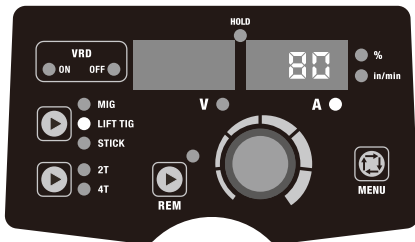


**Image 6:** Default current in LIFT TIG mode



**Image 8:** Default voltage in MIG mode

3. The [multifunctional display] shows the default value of the current: “80” in Amperes (A).
4. The [multifunctional adjustment knob] allows current adjustment during welding. The changes are shown on the [multifunctional display].
5. 3 seconds after the configuration of the welding parameters the [multifunctional display] blinks one time indicating that the data is saved. Further, the machine will show the same data the next time it’s started up, if the parameters are not modified.
6. Image 7 shows the display during welding. The default current is 80A.



**Image 7:** Display during welding in LIFT TIG mode

#### 4) Usage instructions in MIG mode

1. With the welder on press the [STICK/LIFT TIG/MIG switch], the LIFT TIG mode indicator light comes up as the machine switches to MIG mode. (Image 8)
2. Wire check function: press the MIG torch switch for 5 seconds in fast wire feeding mode. If you press the switch for 15 seconds, it will stop automatically.
3. The [multifunctional display] shows the default value of the voltage: “19.4V” in Volts (V), the other data “237in/min” means the default wire feed speed in in/min.
4. In MIG mode press the [2T/4T switch] to select the welding mode. The 2T mode refers to a two-step process: press the switch of the welding torch, feed the gas in advance and carry out the welding work as usual. After this, release the switch of the torch, let the wire get consumed, then remove the ball from the end of the wire. Stop the gas feed 3 seconds later. The 4T mode refers to a 4 step process: press the switch of the welding torch, feed the gas in advance and start the arc to carry out the welding. After this, release the switch of the torch and carry out the welding work as usual. Press the switch of the welding torch again, the welding current decreases until it reaches the nominal value, this value will be maintained. Then, release the switch of the welding torch, let the wire get consumed, remove the ball from the end of the wire. Stop the gas feed 3 seconds later.
5. The [multifunctional adjustment knob] allows synergic adjustments during welding to the voltage and the feeding speed, which is shown on the [multifunctional display].
6. Fine adjustments to the welding voltage: in welding configuration mode or in welding mode it is possible to make fine adjustments to the arc voltage. The adjustment range is between -20% to +20%. Press the [MENU selection key] to get into the voltage adjustment mode. Turn the adjustment knob to change the arc voltage (see Image 9). 3 seconds after finalizing the configurations the display returns to the main menu (Image 8).
7. During MIG welding, the wire feed welding wire shorts against the metal to be welded creating intense heat at the wire until it melts and flows into

the work metal. This happens continuously as you weld. While it happens very quickly and repetitively, there is a time lapse from the time the welding wire contacts the work to the time it heats enough to melt. Inductance can lengthen or shorten that time. Many MIG welders come preset from the factory with a default value and cannot be adjusted. The MIG200GDsv has the ability to fine tune that default value by plus (+) or minus (-) 10%. While in the MIG mode, simply tap the menu button to display IND and make your adjustment (see Image 10). Adding some + inductance can lower spatter a bit and shorten the time it takes the welding wire to melt. This also can create a hotter weld. 3 seconds after finalizing the configurations the display returns to the main menu (Image 8).

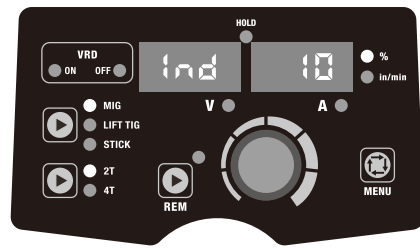


Image 10\_2

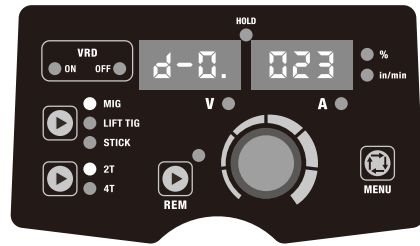


Image 10\_3

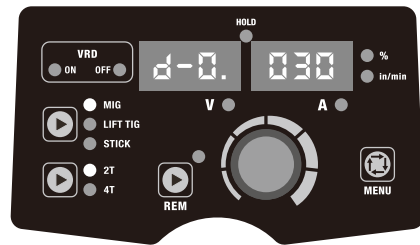


Image 10\_4

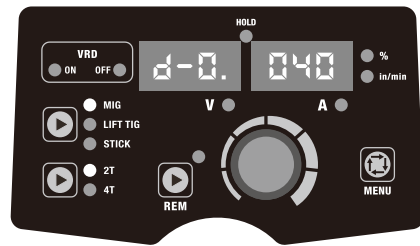


Image 10\_5

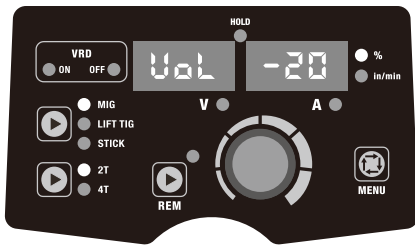


Imagen 9\_1



Image 9\_2

Image 9: Fine adjustment display with default voltage range in MIG mode

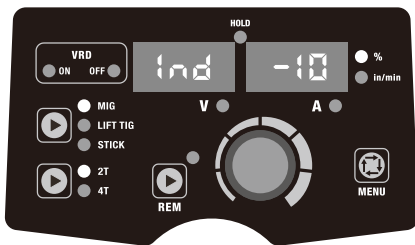


Image 10\_1

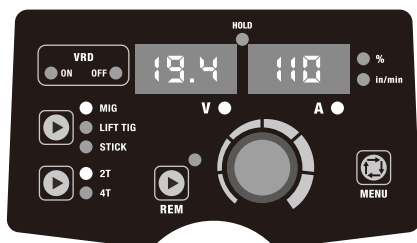
Image 10: Fine adjustment of the inductance in MIG mode.

8. 3 seconds after the configuration of the welding parameters the [multifunctional display] blinks one time indicating that the data is saved. Further, the machine will show the same data the next time it's started up, if the parameters are not modified.
9. Image 10\_3, 10\_4 and 10\_5 are related to the MIG wire "Diameter" settings. This is the third toggle in the MIG mode on the menu button. Toggle to the letter "d" and then you are able to choose from 3 different wire thickness sizes .023 and .030 and .040. Choose the wire diameter that most closely

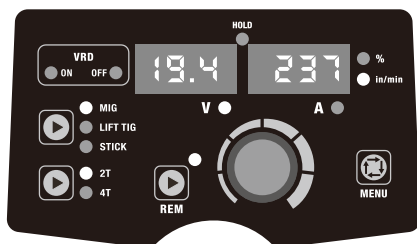
matches the wire you have installed in your machine. This will aid the MIG200GDsv in determining it's synergic settings.

Once you have made your initial adjustments, be sure your work is properly grounded and you have followed all safety procedures including your mask and protective gear, you can test your welding settings

10. Image 11 shows the panel during welding. The value of the voltage is 19.4V, the value of the current is 110A.
11. Stop the welding machine between two welding works. The [multifunctional display] will show the actual voltage and current values. After 2 seconds the display will automatically switch to the voltage and wire feed speed adjustment screen (Image 8).
12. The MIG welding torch and spool gun (Image 12): press the [REM] button. When the indicator light is on, the welding machine is in spool gun mode. When it is off, the machine is in MIG welding torch mode.



**Image 11:** Status while in MIG welding mode



**Image 12:** Status while in spool gun mode

## Error screen: (Image 12)

### 1) Wire feeder error code

The screen shows the “Err -03” error code and it keeps blinking. After troubleshooting the display panel will automatically resume to normal operation and display the last settings before the error.

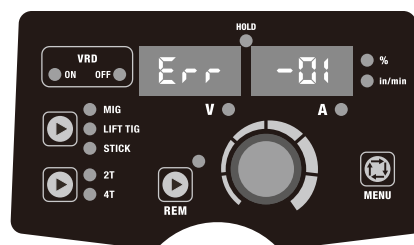
### 2) Overcurrent error code

The screen shows the “Err -01” error code and it keeps blinking. The machine stops working. Reboot the machine. The display will show the last settings before the error.

### 3) Overheating error code

The screen shows the “Err -02” error code and it keeps blinking. The machine stops working, because the overheat protection is activated. Once the machine cools down, the display will show the last settings before the error.

The screen shows the “Err -04” error code and it keeps blinking. The machine stops working, because the temperature sensor is damaged. After troubleshooting the display panel will automatically resume to normal operation and display the last settings before the error.



**Image 12:** Error screen



# RECOMMENDED OPERATING PARAMETERS

1. Generally, the adequate welding current for the electrode welding is as follows:

Electrode specifications	.098"	.126"	.157"	.197"
Welding current	70-100A	110-140A	170-220A	230-280A

2. Welding variables in TIG mode

The specifications for TIG welding with stainless steel are as follows:

Thickness (ga)	Tungsten diameter (in)	Wire diameter (in)	Type of butt joint	Welding current (A)	Gas flow (cfh)
25	0.040	0.040	plain butt joint	35-40	8.4-12.6
21	0.040	0.040	wire filling	35-45	8.4-12.6
19	0.063	0.063		40-70	10.8-16.8
16	0.063	0.063		50-85	10.8-16.8
14	.08-.1	0.78		80-130	16.8-21
11	.078-.12	0.89		120-150	21-25.2

### 3. Welding variables in MIG mode

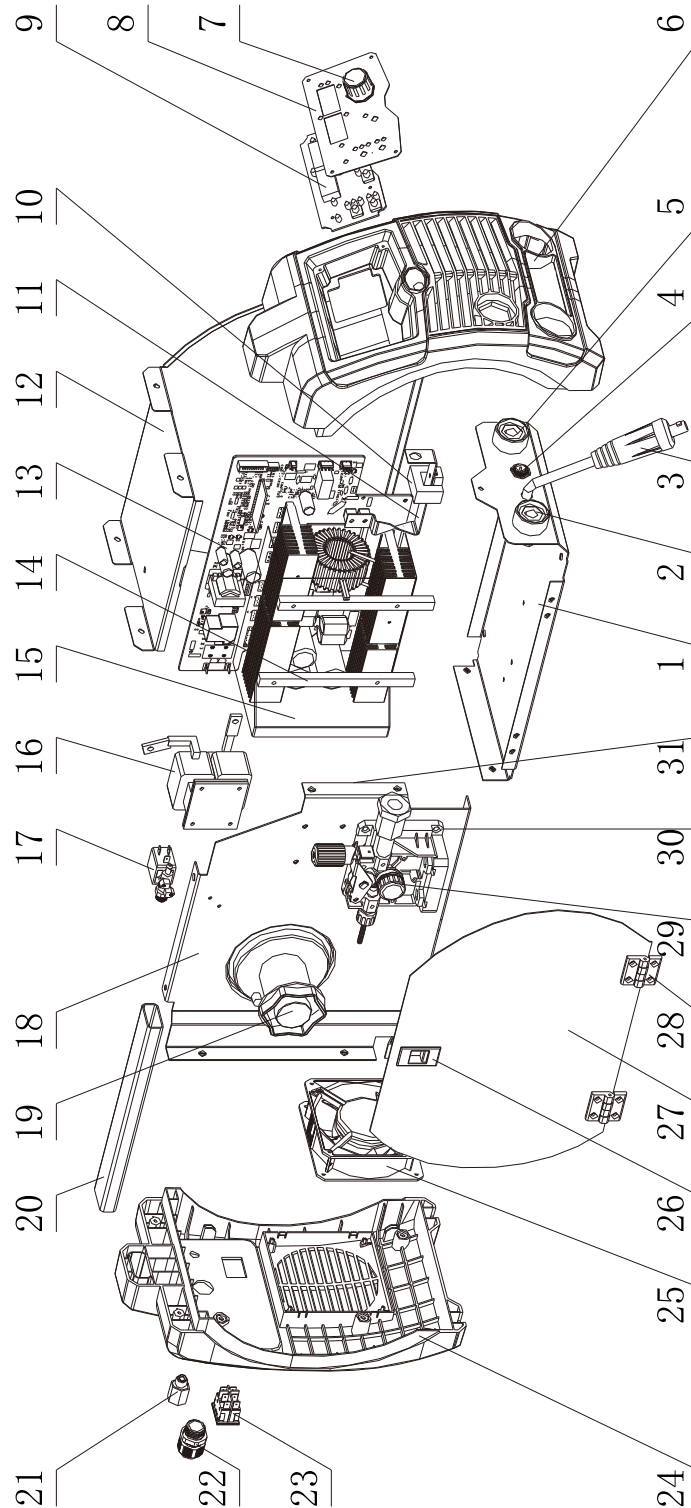
The values listed below are general specifications under standard conditions.

		Plate thickness (ga)	Wire diameter (in)	Interval (in)	Current (A)	Voltage (V)	Welding speed (in/min)	Wire extension (in)	Gas flow rate (cfm)
Square butt welding	Low welding speed	21	.030,.035	0	60~70	16~16.5	19.7~23.6	0.4	0.4
		19	.030,.035	0	75~85	17~17.5	19.7~23.6	0.4	0.4~0.6
		18	.030,.035	0	80~90	16~16.5	19.7~23.6	0.4	0.4~0.6
		15	.030,.035	0	95~105	17~18	17.7~19.7	0.4	0.4~0.6
		14	.040,.047	0~.020	110~120	18~19	17.7~19.7	0.4	0.4~0.6
		13	.040,.047	.020~.040	120~130	19~19.5	17.7~19.7	0.4	0.4~0.6
		10	.040,.047	.040~.047	140~150	20~21	17.7~19.7	0.4~0.6	0.4~0.6
		7	.040,.047	.040~.060	160~180	22~23	17.7~19.7	0.6	0.6
			.047	.047~.063	220~260	24~26	17.7~19.7	0.6	0.6~0.8
			.047	.047~.063	220~260	24~26	17.7~19.7	0.6	0.6~0.8
			.047	.047~.063	300~340	32~34	17.7~19.7	0.6	0.6~0.8
			.047	.047~.063	300~340	32~34	17.7~19.7	0.6	0.6~0.8
	High welding speed	21	.030,.035	0	100	17	51.2	0.4	0.6
		19	.030,.035	0	110	17.5	51.2	0.4	0.6
		18	.030,.035	0	120	18.5	51.2	0.4	0.6
		15	.040,.047	0	180	19.5	51.2	0.4	0.6
		14	.040,.047	0	200	21	39.4	0.6	0.6
		13	.040,.047	0	220	23	47.2	0.6	0.8
		10	.047	0	260	26	47.2	0.6	0.8
		Plate thickness (ga)	Wire diameter (in)	Current (A)	Voltage (V)	Welding speed (in/min)	Wire extension (in)	Gas flow rate (cfm)	
Fillet welding/butt welding	15	.030,.035	60~80	16~17	15.7~19.7	0.4	0.4		
	14	.030,.035	80~100	19~20	15.7~21.7	0.4	0.4~0.6		
	13	.040,.047	120~160	20~22	13.8~17.7	0.4~0.6	0.4~0.6		
	10	.040,.047	150~180	21~23	11.8~15.7	0.4~0.6	0.8~1.0		

		Plate thickness	Wire diameter (in)	Vertical angel of the welding gun	Current (A)	Voltage (V)	Welding speed (in/min)	Wire extension (in)	Gas flow rate (cfm)
Horizontal fillet / butt welding / T joint welding Horizontal fillet / joint welding	Low welding speed	19ga	.030,.035	45°	70~80	17~18	19.7~23.6	0.4	0.4~0.6
		18ga	.035,.040	45°	85~90	18~19	19.7~23.6	0.4	0.4~0.6
		15ga	.040,.047	45°	100~110	19~20	19.7~23.6	0.4	0.4~0.6
		14ga	.040,.047	45°	115~125	19~20	19.7~23.6	0.4	0.4~0.6
		13ga	.040,.047	45°	130~140	20~21	19.7~23.6	0.4	0.4~0.6
		10ga	.040,.047	45°	150~170	21~22	17.7~19.7	0.6	0.6~0.8
		7ga	.040,.047	45°	140~200	22~24	17.7~19.7	0.6	0.6~0.8
		3ga	.047	45°	230~260	24~27	17.7~19.7	0.8	0.6~0.8
		0.35in	.047,.063	50°	270~380	29~35	17.7~19.7	1.0	0.8~1.0
		0.47in	.047,.063	50°	400	32~36	13.8~15.7	1.0	0.8~1.0
	High welding speed	19ga	.030,.035	45°	140	19~20	63	0.4	0.6
		18ga	.035,.040	45°	130~150	19~20	47.2	0.4	0.6
		15ga	.040,.047	45°	180	22~23	47.2	0.4	0.6~0.8
		14ga	.047	45°	210	24	47.2	0.6	0.8
		13ga	.047	45°	230	25	43.3	0.8	1.0
		10ga	.047	45°	270	27	43.3	0.8	1.0
		7ga	.047	50°	290	30	31.5	0.8	1.0
		3ga	.047	50°	310	33	27.6	1.0	1.0
	Low welding speed	21ga	.030,.035	10°	60~70	16~17	15.7~17.7	0.4	0.4~0.6
		18ga	.030,.035	30°	80~90	18~19	17.7~19.7	0.4	0.4~0.6
		15ga	.030,.035	30°	90~100	19~20	17.7~19.7	0.4	0.4~0.6
		13ga	.030,.035	47°	100~130	20~21	17.7~19.7	0.4	0.4~0.6
			.040,.047	47°	120~150	20~21	17.7~19.7	0.4	0.4~0.6
		10ga	.040,.047	47°	150~180	20~22	13.8~17.7	0.4~0.6	0.8~1.0
		7ga	.047	47°	200~250	24~26	17.7~19.7	0.4~0.6	0.8~1.0

# EXPLODED VIEW AND LIST OF MAJOR COMPONENTS

Exploded view of the MIG175/200GDsv



EXPLODED VIEW AND LIST OF MAJOR COMPONENTS

## List of major components of the MIG175/200GDsv

NO.	Component	Quantity	NO.	Component	Quantity
1	Bottom cover	1	17	Magnetic valve	1
2	Welding torch socket (+)	1	18	Separator	1
3	Quick connector	1	19	Spindle	1
4	Welding torch switch socket	1	20	Handle	1
5	Welding torch socket (-)	1	21	Crossover coupling	1
6	Plastic front panel	1	22	Cable retaining nut	1
7	Knob	1	23	Switch	1
8	Output board	1	24	Plastic back panel	1
9	Display board	1	25	Fan	1
10	Holzer current sensor	1	26	Switch lock	1
11	Copper connector	1	27	Cover (left side)	1
12	Cover (right side)	1	28	Hinge	1
13	Motherboard	1	29	Wire feeder	1
14	Transom	1	30	Wire feeder support	1
15	Windshield insulation board	1	31	Copper joint	1
16	Reactor	1			

## 1. Operating environment

1. To be used in dry environments with a maximum humidity level of 90%.
2. The ambient temperature must be between 14 and 104 degrees Fahrenheit.
3. Avoid using the equipment under direct sunlight and rain. Avoid any contact with water.
4. Do not weld in dusty areas or in an environment with corrosive gas.
5. Avoid gas welding in windy areas.

## 2. Safety advice

Our machine is equipped with surge, overcurrent and overheat protection. In case the voltage, the current or the temperature of the machine exceeds the standard values, the welding machine stops automatically. The excessive use with high voltage, current or temperature may damage the machine. Please pay attention to the following points.

### 1) Ensure that the work area is adequately ventilated!

There are two models of this welder: a medium sized and a small one. Both work with high current. Natural airflow is not sufficient to cool down the internal components. For this reason, the machine has a fan to provide stable operation. The exhaust shutter must never be blocked or covered, keep a distance of 11.8" between the machine and other objects. Ensure a well ventilated work area to ensure the best possible performance and the longest possible lifetime.

### 2) Do not overload!

The operator shall ensure to never exceed the maximum allowable current in any kind of duty cycle. Excess workload may damage or burn the equipment.

If the machine exceeds the standard duty cycle, it will stop and switch into protection mode. High temperatures activate the overheat protection. The overheat indication light comes up. If this happens, do not power down the machine, as the internal fan keeps on working in order to cool down the machine. Once the overheat indicator light switches off, the temperature is within the allowable range again, and the machine can be used again.

### 3) Avoid surging!

The input voltage is indicated on the technical data sheet. The automatic voltage compensation circuit will prevent from exceeding the allowable range. If the input voltage is too high, that may damage components. Keep this in mind and take appropriate preventive measures.

- 4) The input voltage is indicated on the technical data sheet. The automatic voltage compensation circuit will prevent from exceeding the allowable range. If the input voltage is too high, that may damage components. Keep this in mind and take appropriate preventive measures.

# POTENTIAL OPERATING PROBLEMS

---

The below listed occurrences may happen due to the accessories used, the welding material, the environment or the power supply. Improve the working environment and prevent these issues.

## A. Difficult arc starting. The arc is constantly interrupted:

1. Check if the grounding clamp is adequately connected to the workpiece.
2. Check if all connectors are connected properly.

## B. The output current does not reach the nominal value:

The deviations from the nominal supply voltage may cause that the output current does not match its pre-established value. When the supply voltage is lower than its nominal value, the maximum output current may be lower than its nominal value, too.

## C. The current is unstable during the operation

This issue may occur due to the following factors:

- 1 The voltage of the electric power network changes.
- 2 The electric power network or other electric installations cause serious interference.

## D. Gas spills into the weld

- 1 Check if the gas supply circuit has any leakage.
- 2 Check whether there is residue on the surface, like oil, dirt, rust, paint etc.

# MAINTENANCE



## WARNING

**The power must be cut off completely before starting any repair or maintenance. Make sure that the power supply cable is disconnected before you open the housing.**

1. Remove dust regularly with a dry cloth. If the welding machine is used in an environment with heavy smoke and/or polluted air, the dust must be removed at least once a month.
2. The pressure of the compressed air must be adjusted to the required level to avoid damaging the small components of the machine.
3. Revise the internal connections and ensure a perfect contact (especially plugs and sockets). Fasten any loose connections. If they are oxidized, remove it with sandpaper and connect again.
4. Prevent water from entering the machine and the machine from getting wet at all times. If so, air dry it. Measure the insulation with a megohmmeter to make sure it's safe to use the machine.
5. If the machine is not in use for a prolonged period of time, put it in its original package and store it in a dry place.
6. The wire feeder's electric carbon brush must be sharpened, and its wire guide must be cleaned after each 300 hours of operation. Rinse the speed reducer, apply 2# Molybdenum disulfide lubricant on the turbine, pivot rod and bearing.

# TROUBLESHOOTING

**Note** : The following operations must be carried out by a qualified electrician with valid certifications. Before maintenance, you are suggested to contact a local dealer to verify said qualification.

## MIG175/200GDsv: faults and troubleshooting measures

Fault description	Measures to take
<p>The meter shows nothing. The fan is not on. There is no welding output.</p>	<ol style="list-style-type: none"> <li>1. Check if the power switch is on.</li> <li>2. Check if the power cord has current.</li> <li>3. Check if the silicone bridge is damaged.</li> <li>4. Malfunction of the supplementary power source located on the control board. (contact your dealer).</li> </ol>
<p>The meter works properly. The fan works properly. There is no welding output.</p>	<ol style="list-style-type: none"> <li>1. Check if all connectors of the machine are well connected.</li> <li>2. There is a short circuit or a malfunction in the connection of the output terminal.</li> <li>3. The control cable of the welding torch is broken or the switch is damaged.</li> <li>4. The control circuit is damaged (contact your dealer).</li> </ol>
<p>The meter works properly. The fan works properly. The indicator lights function abnormally.</p>	<ol style="list-style-type: none"> <li>1. The overcurrent protection may be activated. Turn off the power switch and restart the machine.</li> <li>2. The overheat protection may be activated. Wait 2-3 minutes until the machine starts working again. Do not turn off the power supply.</li> <li>3. There may be a malfunction in the inverter circuit (contact your dealer).</li> </ol>



# INITIAL PROBLEM DETECTION

Even though the machine has a built in device for the detection of malfunction (like issues with starting the arc, unstable arc, or problems with the weld), this may be insufficient for the detection of some malfunction.

Malfunction may have several reasons. For example loose parts, disconnected connectors, incorrect configuration, damaged cables or gas hose, etc. Therefore, please consider these factors before returning the machine, as the most of the time these problems can be resolved easily.

Please find below a table for the initial detection of some common problems during welding. Possible issues are listed in the "Error" row (top row of the list). Revise and fix the items marked with an "o" in the column of the error experienced.

## Initial problem detection

Areas and components to revise and fix		Error								
		Arc not starting	No gas output	Wire does not feed	Arc starting difficulties	Unstable arc	Dirt on the weld seam	Wire sticks to the base metal	Wire sticks to conductive tip	Formation of bubbles
Distribution boxes (input protection devices)	<ol style="list-style-type: none"> <li>1. Is the power supply turned on?</li> <li>2. Blown fuse.</li> <li>3. Loose connection.</li> </ol>	<input type="radio"/>	<input type="radio"/>	<input type="radio"/>	<input type="radio"/>	<input type="radio"/>	<input type="radio"/>			
Input cable	<ol style="list-style-type: none"> <li>1. Check if the cable is cut off.</li> <li>2. Loose connection.</li> <li>3. Overheating.</li> </ol>	<input type="radio"/>			<input type="radio"/>	<input type="radio"/>	<input type="radio"/>			
Welding power supply	<ol style="list-style-type: none"> <li>1. Is the power supply on?</li> <li>2. Phase failure/loss.</li> </ol>	<input type="radio"/>	<input type="radio"/>	<input type="radio"/>	<input type="radio"/>	<input type="radio"/>	<input type="radio"/>	<input type="radio"/>	<input type="radio"/>	
Gas cylinder and gas regulator	<ol style="list-style-type: none"> <li>1. Turn on the gas supply.</li> <li>2. Waste gas in the cylinder.</li> <li>3. Set flow value.</li> <li>4. Loose connection.</li> </ol>					<input type="radio"/>				<input type="radio"/>
Gas supply hose (from the high pressure cylinder to the welding torch)	<ol style="list-style-type: none"> <li>1. Loose connection.</li> <li>2. Damaged gas hose.</li> </ol>									<input type="radio"/>

INITIAL PROBLEM DETECTION

## Initial problem detection

Areas and components to revise and fix	Error	Arc not starting	No gas output	Wire does not feed	Arc starting difficulties	Unstable arc	Dirt on the weld seam	Wire sticks to the base metal	Wire sticks to conductive tip	Formation of bubbles
Wire feeding device	<ol style="list-style-type: none"> <li>The wire feeding reel does not match the diameter of the wire in the texturing tube.</li> <li>The wire feeding reel makes noise. Blocked or .damaged opening.</li> <li>Handle too loose or too tight.</li> <li>Wire dust accumulated at the SUS pipe inlet.</li> </ol>			○	○	○	○	○		
Welding torch and its cable	<ol style="list-style-type: none"> <li>The cable of the welding torch is rolled up or folded.</li> <li>Adaptability of the conductive tip, wire feeding pipe, cable diameter. Exhaustion, blockage, deformation etc.</li> </ol>	○			○	○	○			
Body of the welding torch	<ol style="list-style-type: none"> <li>Loose connection of the conductive tip, nozzle and nozzle connector.</li> <li>The connector of the body of the welding torch is not plugged in or tightened properly.</li> </ol>							○		○
Power supply cable of the welding torch and the cable of the switch control	<ol style="list-style-type: none"> <li>Broken (bending fatigue).</li> <li>Damaged due to weight.</li> </ol>	○	○	○		○		○		
Surface of the base material and wire stretch length	<ol style="list-style-type: none"> <li>Oil, dirt, rust and paint residue.</li> <li>Excessive wire stretch length.</li> </ol>				○	○	○	○		○
Output cable	<ol style="list-style-type: none"> <li>The cross section of the cable connected to the base material is insufficient.</li> <li>Loose connection at the (+) or (-) terminal of the output cable.</li> <li>The base material's electrical conductivity is low</li> </ol>				○	○	○			
Extension cable	<ol style="list-style-type: none"> <li>The cross section of the extension cable is insufficient.</li> <li>The cable is rolled up or folded.</li> </ol>				○	○	○	○		
Working conditions for welding	Verify the welding current, voltage, the inclination of the torch, the type of welding and the stretch length of the wire.				○	○	○	○	○	

## WELDING POWER SUPPLY

Component	To check	Remarks
Control panel	1. Check the operating conditions, transfer and installation. 2. Check the power supply indicator light.	
Cooling fan	1. Check if the fan works and if the sound emitted is as usual.	If the fan is not working, but you can hear an unusual sound, check inside.
Electrical components	1. Check for any unusual smell when electrified. 2. Check if the machine vibrates or buzzes unusually when electrified. 3. Check if the machine changes color or heats up.	
Peripheries	1. Check if the gas tube is damaged or loose. 2. Check if the housing and other fixed parts are loose.	

## WELDING TORCH

Component	To check	Remarks
Nozzle	Check if the torch is properly connected and if there are any deformations.	There may be an air leak
	Check if it produces splatter.	The welding torch might burn out (use spatter resistant materials)
Electric outlet	Check if the torch is properly connected.	The screw thread of the welding torch may be damaged.
	Check if the head is damaged and if the orifice of the outlet is blocked.	May cause unstable arc or block arc starting.
Wire supply tube	Check the size of the tube extension piece.	The tube must be at least .230in. If the extension piece is too small, the arc is unstable.
	Check if the diameter of the wire matches the inner diameter of the tube.	May cause unstable arc. Use an adequate tube.
	Check the reel and the extension piece.	May result in poor wire supply and unstable arc. Change the tube.
	Check for blockage caused by dirt or wire residue.	May result in poor wire supply and unstable arc (clean the tube with kerosene or change it)
	Check if the wire supply tube is damaged.	The tube was damaged by heat. Change it.
Gas outlet	The tube is not connected or it is blocked or you are using a tube other than the recommended.	May result in splatter due to inadequate gas shielding. The body of the welding torch might burn out (arc started in the torch).

## WIRE FEEDING SYSTEM

Component	To check	Remarks
Press arm	Check if the arm is at the correct level.	May cause unstable arc and wire supply difficulties.
Wire lead tube	Check if there is dust or accumulated residue at the mouth of the tube.	Clean the residue, find out the reason of the problem and correct it.
	Check if the diameter of the wire matches the inside diameter of the tube.	If they don't match, the arc will be unstable and residue will accumulate.
	Check if the center of the mouth of the tube matches the center of the wire reel's slot (by looking at it)	If they don't match, the arc will be unstable and residue will accumulate.
Wire reel	Ensure that the diameter of the wire is adequate for the reel. Check if the slot of the reel is blocked.	1. May result in an unstable arc and accumulation of residue, which might block the tube. 2. Change it, if necessary.
Clamp nut	Check the stability of the movement, the wear down of the clamped wire and the narrowing of the contact surface.	May cause an unstable arc and poor wire supply.

## CABLES

Component	To check	Remarks
Cable of the welding torch	1. Check if the cable of the welding torch is bent too much. 2. Check if the mobile connector is well connected.	
Output cable	1. The insulation is worn down. 2. The cable connector is naked (damaged insulation) or loose (primary point between the power supply and the cable)	If the fan is not working, but you can hear an unusual sound, check inside.
Input cable	1. Check if the connection between the plug and the power socket is proper. 2. Check if the connector of the input cable is connected properly. 3. Ensure that the input cable is not worn down and that the conductor is not exposed.	
Grounding cable	Check if the ground cable connecting to the workpiece is not broken and ensure that it's connected properly.	



**LINLONG LIMITED**

[www.weldpro.com](http://www.weldpro.com)