



Electric Snow Thrower Operator's Manual



WARNING:

Read carefully and understand all **INSTRUCTIONS** before operating. Failure to follow the safety guidelines and other basic safety precautions may result in serious personal injury. Save these instructions in a safe place and on hand so that you can refer to it when required. Keep these instructions to assist in future servicing.

PRODUCT SPECIFICATIONS

18" ELECTRIC SNOW THROWER	
Voltage	120 V~ 60 Hz
Ampere	15 A
Clearing width	18" / 45.7cm
Maximum throwing distance	25' / 7.6m
Maximum snow intake height	10" / 25.4cm
Wheel size	5 1/2" / 14cm
Machine weight	29 3/4 lb/ 12kg

TABLE OF CONTENTS

- Product Specifications ----- 2
- Table of Contents ----- 2
- General Safety Warnings ----- 3
- Important Safety Instructions ----- 3
- Sight and Hearing Protection ----- 3
- Electrical Safety ----- 3-6
- Work Area Safety ----- 3
- Electrical Safety ----- 3
- Personal Safety ----- 4
- Power Tool Use and Care ----- 4
- Specific Safety Instructions ----- 5
- Extension Cord Safety ----- 7
- Symbols ----- 8
- Know Your Electric Snow Thrower ----- 9
- Assembly and Operation ----- 9
- Dual LED Headlight Operation ----- 11
- Maintenance ----- 12
- Storage ----- 12
- Exploded View ----- 13
- Parts List ----- 14-16

GENERAL SAFETY WARNINGS

IMPORTANT SAFETY INSTRUCTIONS

Read and understand all safety and operational instructions. Failure to follow the safety guidelines listed below and other basic safety precautions may result in serious personal injury. Keep this manual, sales receipts and applicable warranty forms for future reference.

SIGHT and HEARING PROTECTION



ALWAYS WEAR EYE PROTECTION THAT CONFORMS WITH CSA REQUIREMENTS OR ANSI SAFETY STANDARD Z87.1

FLYING DEBRIS can cause permanent eye damage. Prescription eyeglasses are not a replacement for proper eye protection .

WARNING: Noncompliant eyewear can cause serious injury if broken during of a power tool.

WARNING: Use appropriate hearing protection equipment, particularly during extended periods of operation of this device.

ELECTRICAL SAFETY



WARNING: To avoid electrical hazards, fire hazards or other damage to the tool, use proper circuit protection.

This tool is wired at the factory for 120V AC operation. It must be connected to a 120V AC, 15 AMP circuit that is protected by a time-delayed fuse or circuit breaker. To avoid shock or fire, replace power cord immediately if it is worn, cut or damaged in any way.

WARNING: Read all safety warnings and instructions. Failure to follow the and instructions may result in electric shock , fire and/or serious injury.

WORK AREA SAFETY

Maintain a clean and well lit work area. Cluttered or insufficiently illuminated work space invite accidents.

Do not operate power tools in the presence of flammable liquids, fumes or dust. Power tools create sparks which may ignite the dust or fumes.

Keep children and bystanders away while operating a power tool. Distractions can cause you to lose control or your power tool and lead to hazardous conditions.

ELECTRICAL SAFETY

Power tool plugs must match the outlet. Never modify the plug in any way. Do not use any adapter plugs with earthed (grounded) power tools. Unmodified plugs and matching outlets will reduce risk of electric shock.

Avoid body contact with earthed or grounded surfaces such as pipes, radiators, ranges and refrigerators. There is an increased risk of electric shock if your body is earthed or grounded.

Do not expose power tools to rain or wet conditions. Water entering a power tool will increase the risk of electric shock.

Do not abuse the cord. Never use the cord for carrying, pulling or unplugging the power tool. Keep cord away from heat, oil, sharp edges or moving parts. Damaged or entangled cords increase the risk of electric shock.

When operating a power tool outdoors, use an extension cord suitable for outdoor use. Use of a cord suitable for outdoor use reduces the risk of electric shock.

If operating a power tool in a damp location is unavoidable, use a residual current device (RCD) protected supply. Use of a ground fault circuit interrupter (GFCI) reduces the risk of electric shock.

PERSONAL SAFETY

Stay alert, watch what you are doing and use common sense when operating a power tool. Do not use a power tool while you are tired or under the influence of drugs, alcohol or medication. A moment of inattention while operating power tools may result in serious personal injury.

Use personal protective equipment. Always wear eye and ear protection. Protective equipment, such as dust masks, nonskid safety shoes, hard hats, or hearing protection used for appropriate conditions will reduce chances for personal injuries.

Prevent unintentional starting. Ensure the switch is in the off-position before connecting to power source and/or battery pack, picking up or carrying the tool. Avoid carrying power tools with your finger on the switch invites accidents.

Be certain to remove any adjusting key or wrench before turning the power tool on. A wrench or a key left attached to a rotating part of the power tool may result in personal injury.

Maintain proper footing and balance at all times. This enables proper control of the power tool in unexpected situations .

Dress Appropriately. Do not wear loose clothing or jewelry. Keep your hair, clothing and gloves away from moving parts. Loose clothing, jewelry or long hair can be caught in moving parts.

POWER TOOL USE AND CARE

Do not use the power tool if the switch does not turn it on and off. Any power tool that cannot be turned on/off by its power switch is dangerous and must be repaired prior to usage.

Disconnect the plug from its power source or remove the battery pack from the tool before making any adjustments, changing accessories, or storing power tools. Such preventative safety measures reduce the risk of starting the power tool accidentally.

Store idle power tools out of the reach of children and do not allow persons unfamiliar with the power tool or these instructions to operate the power tool. Power tools are dangerous in the hands of untrained users.

Maintain power tools. Check for misalignment or binding of moving parts, breakage of parts and any other condition that may affect the power tool's operation. If damaged, have the power tool repaired before use. Many accidents are caused by poorly maintained power tools.

SAVE THESE INSTRUCTIONS FOR REFERENCE

Keep cutting tools sharp and clean. Properly maintained cutting tools with sharp cutting edges are less likely to bind and are easier to control.

Use the power tool, accessories and tool bits etc. in accordance with these instructions, taking into account the working conditions and the work to be performed. Use of the power tool for operations different from those intended could result in a hazardous situation.

Use auxiliary handles supplied with the tool. This will reduce the opportunity to lose control of your tool and reduce the chances for personal injury.

SPECIFIC SAFETY INSTRUCTIONS

Safety Instructions for Walking Behind Snow Throwers

Read the operator's manual carefully - Learn your snow thrower's applications and limitations as well as the specific potential hazards related to this machine. Do not use this machine for any purpose other than the one for which it was designed.

Preliminary unit inspection - Thoroughly inspect the unit before use. Make sure all the parts are secure and installed correctly. If you notice any abnormalities, do not use the machine until it has been properly repaired. Always perform a test run the first time you use the snow thrower or after replacing parts to ensure that the unit is functioning properly.

Preliminary area inspection - Clear the area to be plowed before each use. Remove all objects, such as rocks, broken glass, nails, wire or string, which can be thrown by or become entangled in the snow thrower. Keep the area of operation clear of all spectators, particularly children and pets.

Excessive force -The snow thrower was designed to respond at a certain rate for various snow conditions for optimum safety and performance. Maintain steady constant pressure while pushing the Snow Thrower.

Hitting an object - If the snow thrower accidentally strikes an object, follow these steps: i) Stop the snow thrower and unplug the unit. ii) Inspect for damage. iii) Repair or replace any damaged part before restarting and operating the snow thrower.

Discharge chute safety - Never direct the snow discharge chute at the operator, bystanders, vehicles, or at windows. The discharged snow stream may contain foreign objects accidentally picked up by the snow thrower, such as rocks or other debris can cause serious damage and personal injury. Do not use your hands to unclog the discharge chute. Stop the motor before removing debris.

Abnormal operation - If you notice the snow thrower running in an unstable state or hear abnormal sounds from the engine, immediately stop the machine, disconnect the power and contact Customer Service at 1-866-349-8665.

Noise control - When using the snow thrower, you must respect local laws and regulations regarding noise pollution and environmental protection. To avoid noise disturbance, you should carefully decide upon an appropriate operation time and consider the surrounding conditions.

Store safely - Store the snow thrower indoors in a dry area between uses. Keep it in a locked area where children and unauthorized users cannot gain access. Do not store the machine while it is still connected to the power source as this may result in damage and injury.

Maintenance for safety and longevity - Use only original replacement parts designed specifically for your model. When replacing any parts, you must strictly observe the instructions and procedures described in this manual. Special care should be paid to any rubber parts, since these parts may increase the engine load and decrease its mechanical power if damaged or replaced improperly. Always check that all bolts, nuts and knobs are tight before using the snow thrower!

WARNING: Clearing a clogged discharge chute -Hand contact with the impeller inside the discharge chute is the most common cause of injury associated with snow throwers.

Never use your hand to clean out the discharge chute. To clear the chute : SHUT THE MOTOR OFF! Wait 10 seconds to be sure the impeller blades have stopped rotating. Always use a clean-out tool, not your hands.

INTENDED USE: This tool is intended for snow throwing. It is only for outdoor usage.

NOTE: Read the instruction handbook before operating this machine.

EXTENSION CORD SAFETY

WARNING: Keep the extension cord clear of the working area. Position the so it will not get caught on the work space, tools or any other obstructions while you are working with the power tool.

Make sure any extension cord used with this tool is in good condition. When using an extension cord, be sure to use one of heavy enough gauge to carry the current load that the tool requires. An undersized cord will cause a drop in line voltage resulting in loss of power and overheating. And shorten the work life of your tool.

The table below shows the correct gauge of power cord to use according to cord length and ampere rating. If in doubt, use the next heavier gauge. The smaller the gauge number the heavier the cord.

Be sure your extension cord is properly wired and in good condition. Always replace a damaged extension cord or have it repaired by a qualified electrician before using it. Protect your extension cord from sharp objects, excessive heat and damp or wet areas.

Use a separate electrical circuit for your power tools. This circuit must not be less than 14-gauge wire and should be protected with either a 15 AMP time delayed fuse or circuit breaker. Before connecting the power tool to the power source, make sure the switch is in the OFF position and the power source is the same as indicated on the nameplate. Running at lower voltage will damage the motor.





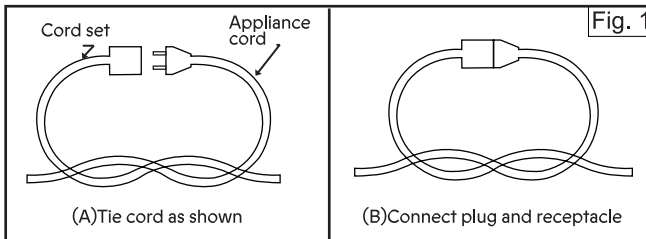

MINIMUM GAUGE (AWG)		EXTENSION CORDS (120V use only)			
Amperage rating		Total length			
More than	Not more than	25' (7.5 m)	50' (15 m)	100' (30 m)	150' (45 m)
0	6	18	16	16	14
6	10	18	16	14	12
10	12	16	16	14	12
12	16	14	12	Not Applicable	

To reduce the risk of disconnecting of snow thrower from the extension cord during operating: Make a knot as shown in Fig. 1.

Use one of the plug receptacles retaining straps or connectors described in this guide.



SYMBOLS

	Warning!
	Read the operator 's manual.
	Wear ear protection .
	Double insulation.
	Before any work on the machine itself, pull the power plug from the outlet.
	Wear face shield.

	Avoid injury from rotating auger. Keep hands, feet, and clothing away.
	Wear head protection.
	Wear protective gloves.
	Wear safety footwear.
	Remove plug from the mains immediately if the cable is damaged or cut.
	Shut off motor before unclogging discharge chute .

KNOW YOUR ELECTRIC SNOW THROWER

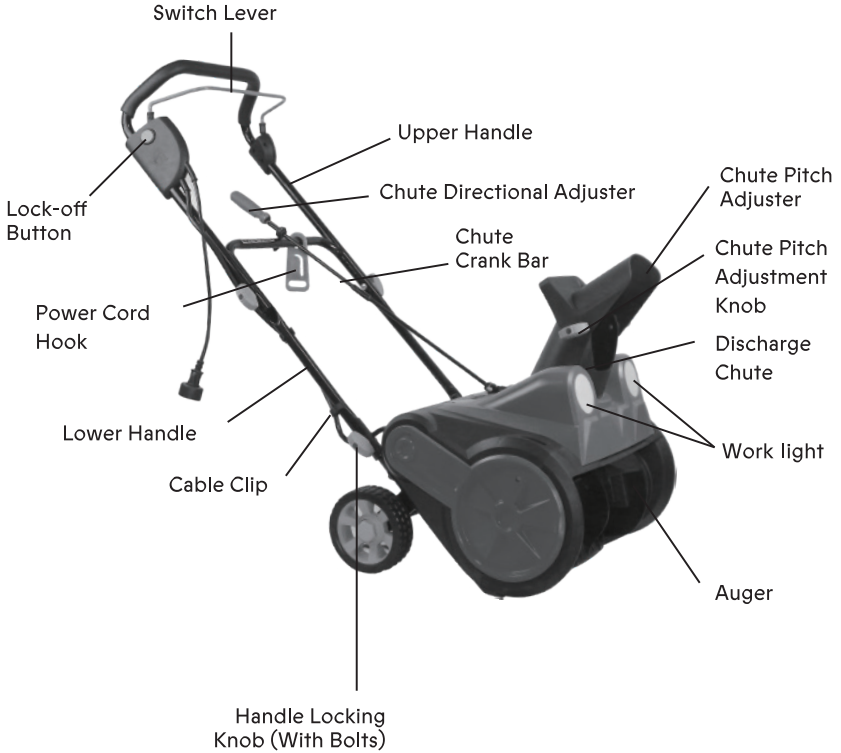

ASSEMBLY AND OPERATION

Assembling the handle

NOTE: Choose one of the three holes in the lower handle for the desired handle's height when attaching the upper handle.

IMPORTANT: When attaching the lower handle to the snow thrower, make sure the chute crank bar mounting hole on the lower handlebar is facing upwards (side of bar where hole is indented). (See Fig. 2-Fig.4)

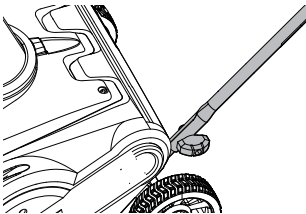

Fig.2

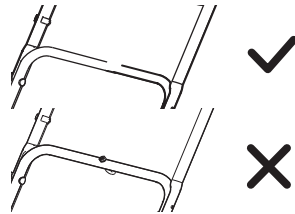

Fig.3

Assembling the handlebar (See Fig. 5)

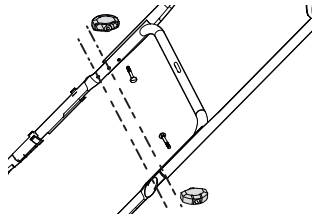

Fig.4

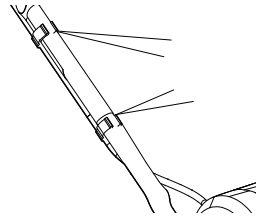

Fig.5

Assembling the chute crank (See Fig. 6 - Fig. 9)

NOTE: Make sure the chute crank bar rests on top of the lower handlebar.

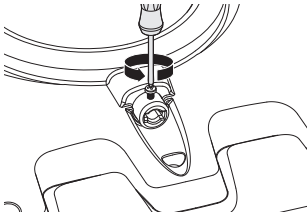

Fig.6

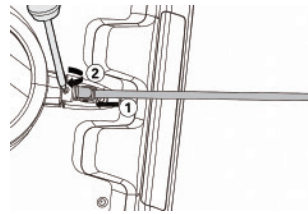

Fig.7

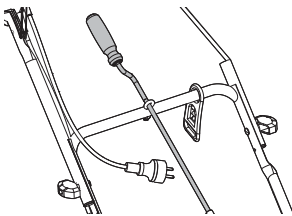

Fig.8

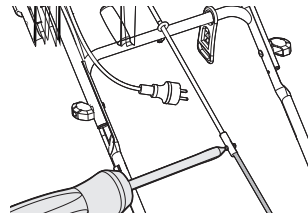

Fig.9

Adjusting throw direction and throw height

NOTE: The discharge chute can be adjusted 180 degrees by rotating the chute directional adjuster.

Always orient the discharge chute in the opposite direction from where you, bystanders, surrounding vehicles, or windows are located.

WARNING: Make sure that the chute pitch adjuster snaps and locks completely onto the discharge chute.

An opening between the discharge chute and the chute pitch adjuster may allow foreign objects to be picked up by the snow thrower and thrown in the direction of the operator causing serious boldly injury. Do not advance the chute pitch adjuster too far forward causing an opening to appear between the chute pitch adjuster and discharge chute. (See Fig. 10-Fig. 11).

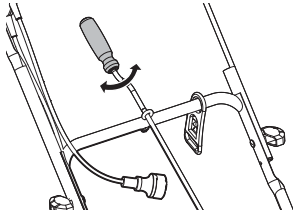

Fig.10

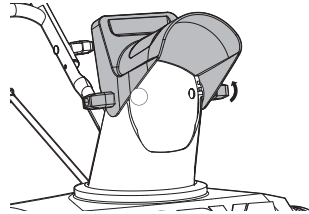

Fig.11

Using the power cord hook (See Fig. 12)
Starting & stopping (See Fig. 13)

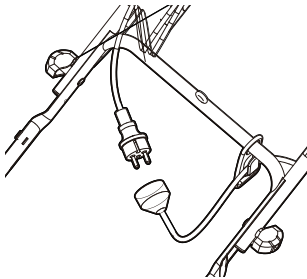

Fig.12

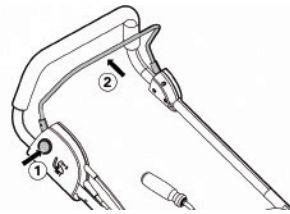

Fig.13

Dual LED Headlight operation

How to operate dual LED headlights:

Plug in as Fig.12

Press main switch lever as Fig.13 and headlights will turn ON. Release main switch lever as Fig.14.2, and headlights will turn off.



Fig.14

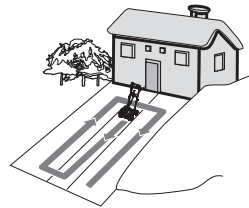

Fig.15

HOW TO CLEAR A DRIVEWAY/EXPERTS OFFER PRACTICAL TIPS (See Fig. 15) SNOW THROWER (NON- WINDY CONDITIONS).

- 1) Cut a path straight down the middle of the driveway with the Discharge Chute facing left.
- 2) Without adjusting the Discharge Chute, turn machine around 180 degrees.
- 3) Return to driveway's start. Turn machine the same direction as before.
- 4) Continue making circles outward in this direction until the driveway is clear.

MAINTENANCE

Important: All electrical repairs should be performed only by an Authorized Service Dealer.

1. GENERAL MAINTENANCE TIPS

- 1) Do not attempt to repair the machine unless you have the proper tools and instructions for disassembly and repair of the machine.
- 2) Check bolts at frequent intervals for proper tightness to ensure that the equipment is in safe working condition.
- 3) After each snow removal session, run the snow thrower for a few minutes to prevent the Auger from freezing. Shut off the motor, wait for all revolving parts to come to a complete stop prior to cleaning , and wipe residual ice and snow off the unit. Rotate the Chute Crank Handle several times to remove any excess snow.

2. REPLACING THE SCRAPER (See Fig . 16)

The scraper (A) is located at the base of the snow thrower beneath the rotor housing.

- 1) Detach the worn scraper from the snow thrower by removing the 3 screws that hold it in place.
- 2) Install the new scraper and fasten it securely to the snow thrower with 3 screws.

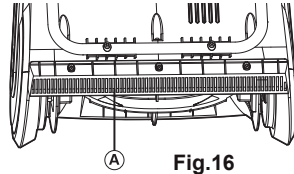
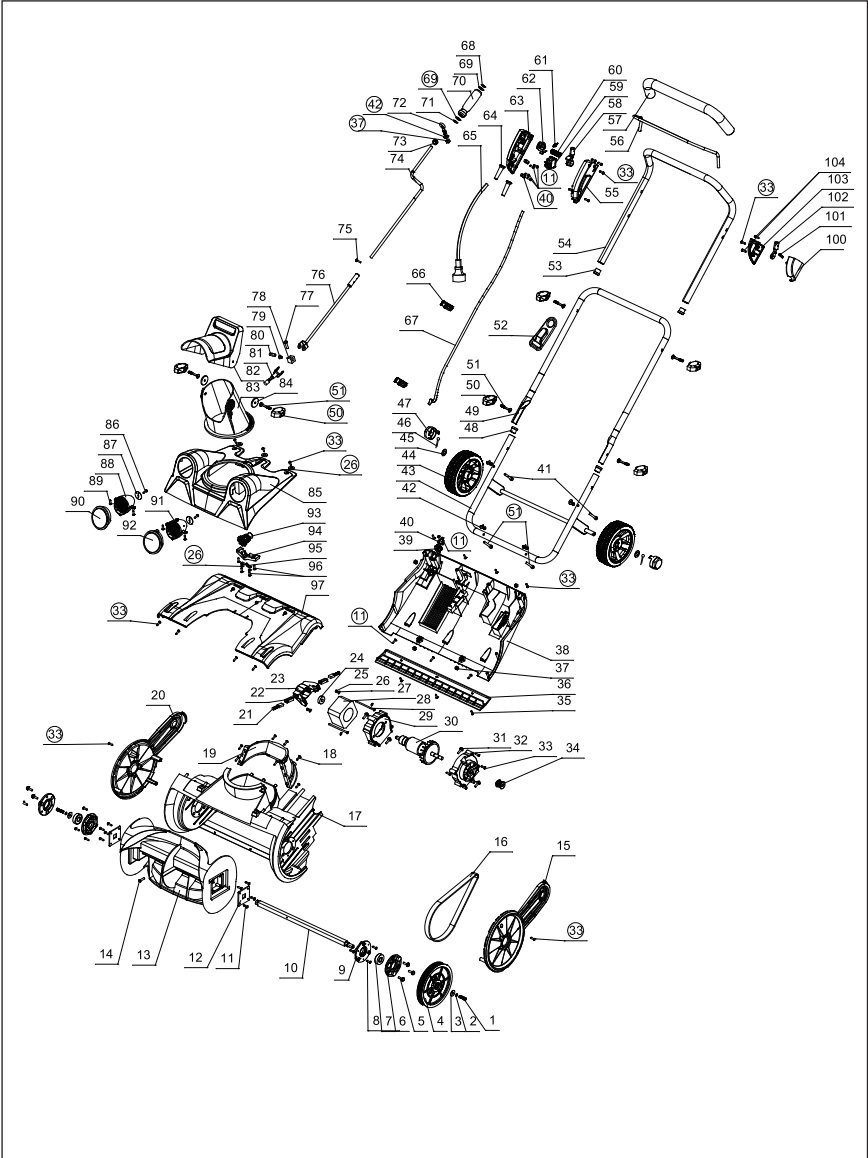

Fig.16

STORAGE

- 1) Allow the motor to cool and clean the snow thrower before storing or transporting . Be sure to secure the unit while transporting.
- 2) Disconnect the extension cord from the snow thrower.
- 3) Store the unit , along with the disconnected extension cord, in a locked, dry place out of the reach of children to prevent unauthorized use or damage. Cover loosely with a tarp for added protection.

EXPLODED



PARTS LIST

WARNING: When servicing, use only original equipment replacement parts. Use of any other parts may create a safety hazard or cause damage to the electric snow thrower.

Key #	Part Name	Quantity
1	screw	2
2	elastic washer	2
3	chute shaft washer	2
4	main pulley	1
5	screw	6
6	chute bearing seat	2
7	6202R waterproof bearing	2
8	ST4*14 screw	6
9	chute bearing seat cover	2
10	chute shaft	1
11	ST4*16 screw	17
12	transfer board	1
13	chute	1
14	M5*20 washer screw	1
15	left cover	1
16	belt	1
17	base seat	1
18	ST4*16 screw	7
19	housing component	1
20	right side cover	1
21	brush	2
22	brush box	2
23	motor rear frame	1
24	608 bearing	1
25	M4 nonmetal nut	2
26	washer	2
27	120V stator	1
28	M4*80 screw	2
29	lower guard	1
30	120V rotor	1

Key #	Part Name	Quantity
31	ST5*30 screw	4
32	lower cover seat	1
33	ST4*20 screw	23
34	small belt	1
35	ST4*14 screw	3
36	snowboarding	1
37	M6 nonmetal nut	4
38	lower cover	1
39	wires sleeve	1
40	cord clamp	3
41	M6*40 bolt	4
42	diameter 6 washer	4
43	lower tube assembly	1
44	front wheel	2
45	washer	4
46	open pin	2
47	wheel cover	2
48	lower bushing	2
49	middle tube	1
50	turn button	6
51	M6*40 bolt	6
52	wire buckle	1
53	upper tube block	2
54	upper tube	1
55	switch box	1
56	trigger	1
57	sponge sleeve	1
58	right trigger link	1
59	recover boat type switch	1
60	switch spring	1
61	tension spring	1
62	switch button	1
63	switch box	1
64	strain relief	2
65	power cord	1
66	buckle 2	2
67	wire	1
68	open ring	1
69	driven wheel washer	2
70	rocking handle	1
71	snap ring	1
72	rocking lever seat	1

Key #	Part Name	Quantity
73	rocking level sleeve	4
74	upper reversing bar	1
75	M4*14 screw	23
76	lower reversing bar welding part	1
77	rivet	3
78	cardan joint	1
79	snap ring	4
80	cardan shaft	1
81	reversing shaft coupling	1
82	up snow thrower tube	3
83	lower snow thrower tube	4
84	snow thrower rubber cushion	4
85	snow thrower seat	1
86	ST4*8 screw	2
87	LED light	4
88	right light seat	2
89	ST4*16 screw	2
90	right LED cover	2
91	left LED seat	1
92	left LED cover	6
93	reversing screw	6
94	reversing screw plate	1
95	brake spring plate	2
96	ST4*14 screw	1
97	upper cover	1
100	switch box	1
101	trigger spring	1
102	left trigger link	1
103	switch box	1
104	ST4*30 screw	1



Great Circle USA
 Support Line: 1-866-493-0524
 help@greatcircleus.com
 www.greatcircleus.com

SIZE:140x216mm

157g双铜

REV 07/06/21