

POWERSMART[®]

INSTRUCTION MANUAL

2500W Inverter Generator

Model # **PS5020W**

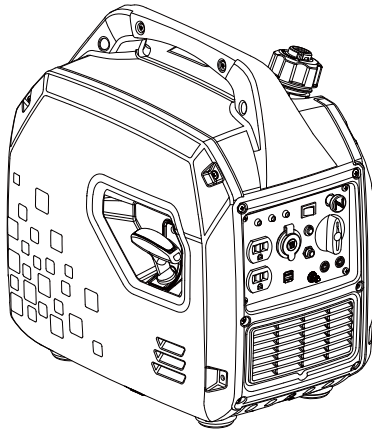

Have product questions or need technical support? Please scan the QR code to enter our official website and contact us!

Website: www.powersmartusa.com

Toll free: 1-800-791-9458 & 1-888-293-0024 Mon-Fri 9-5 EST

Email: support@powersmartusa.com & support@amerisuninc.com



Website

CONTENTS

Technical data..... 3
Introduction..... 4
Safety information..... 4
General safety procedures 5
Important safety instructions..... 6
Knowing your generator..... 7
Generator preparation..... 8
 Step 1 Add oil..... 8
 Step 2 Add gasoline..... 9
 Step 3 Ground the generator..... 9
Starting the generator..... 10
Stopping the generator..... 12
Using the generator..... 13
Maintenance..... 15
Storage & transport procedures..... 18
Troubleshooting..... 18
Wiring diagram..... 20
Exploded view & parts list..... 21
Warranty..... 25

TECHNICAL DATA

2500W Inverter Generator	Model # PS5020W
Engine type:	4 stroke, OHV, single cylinder with forced air-cooling system
Spark plug gap:	0.6-0.8 mm (0.024-0.031 in)
Displacement:	79 cc
Fuel tank capacity:	1.05 gallons
Oil capacity:	16.9 fl.oz
Rated wattage:	1900W
Starting wattage:	2500W
Rated voltage:	120V
Rated current:	15.8A
Frequency:	60Hz
Phase:	Single
DC output:	12V
USB output voltage	5V
Dimensions (L x W x H):	19.1x13.4x 20.1 in
Noise rating:	56 dB at 23 Feet
Weight:	40.3 lbs.

INTRODUCTION

Thank You for Purchasing a PowerSmart® Product. This manual provides information regarding the safe operation and maintenance of this product. Every effort has been made to ensure the accuracy of the information in this manual. PowerSmart® reserves the right to change this product and specifications at any time without prior notice.



Please keep this manual available to all users during the entire life of the generator.

This manual contains special messages to bring attention to potential safety concerns, generator damage as well as helpful operating and servicing information. Please read all the information carefully to avoid injury and machine damage.

QUESTIONS? PROBLEMS?

In order to answer questions and solve problems in the most efficient and speedy manner, contact Customer Service at **(800) 791-9458 & 1-888-293-0024, Mon-Fri 9am-5pm EST** or email: **support@powersmartusa.com & support@amerisuninc.com**

NOTICE REGARDING EMISSIONS

Engines that are certified to comply with U.S. EPA emission regulations for SORE (Small Off Road Equipment), are certified to operate on regular unleaded gasoline, and may include the following emission control systems: (EM) Engine Modifications and (TWC) Three-Way Catalyst (if so equipped).

SAFETY INFORMATION

Before operating this generator, read and observe all warnings, cautions, and instructions on the generator and in this Owner's Manual.

NOTE: The following safety information is not meant to cover all possible conditions and situations that may occur. Read the entire Owner's Manual for safety and operating instructions. Failure to follow instructions and safety information could result in serious injury or death.

This safety alert symbol is used to identify safety information about hazards that can result in personal injury.



A signal word (**DANGER**, **WARNING**, or **CAUTION**) is used with the alert symbol to indicate the likelihood and the potential severity of injury. In addition, a hazard symbol may be used to represent the type of hazard.

DANGER indicates a hazard, which, if not avoided, will result in death or serious injury.

WARNING indicates a hazard, which, if not avoided, could result in death or serious injury.

CAUTION indicates a hazard, which, if not avoided, might result in minor or moderate injury.

CAUTION when used without the alert symbol, indicates a situation that could result in damage to the engine or generator.

GENERAL SAFETY PROCEDURES

For any questions regarding the hazard and safety notices listed in this manual or on the product, please call (800) 791-9458 & 1-888-293-0024 Mon-Fri 9-5 EST before using the generator. Please read and understand the instructions in this manual before starting the engine or attempting to operate this unit.

DANGER: CARBON MONOXIDE

Using a generator indoors CAN KILL YOU IN MINUTES. Generator exhaust contains carbon monoxide (CO). This is a poison gas you cannot see or smell. If you can smell the generator exhaust, you are breathing CO. But even if you cannot smell the exhaust, you could be breathing CO.

NEVER use a generator inside homes, garages, crawlspaces, or other partly enclosed areas. Deadly levels of carbon monoxide can build up in these areas. Using a fan or opening windows and doors does NOT supply enough fresh air. ONLY use a generator outside and far away from windows, doors, and vents. These openings can pull in generator exhaust.

Even if you use a generator correctly, CO may leak into the home. ALWAYS use a battery-powered or battery-backup CO alarm in the home. If you start to feel sick, dizzy, or weak after the generator has been running, move to fresh air RIGHT AWAY. See a doctor. You may have carbon monoxide poisoning.



WARNING: The exhaust from this product contains chemicals known to the State of California to cause cancer, birth defects, or other reproductive harm.



WARNING: This generator may emit highly flammable and explosive gasoline vapors, which can cause severe burns or even death if ignited. A nearby open flame can lead to explosion even if it isn't directly in contact with gasoline.

- Do not operate near open flame.
- Do not smoke near generator.
- Always operate on a firm, level surface.
- Always turn generator off before refueling. Allow generator to cool for at least 2 minutes before removing fuel cap. Loosen cap slowly to relieve pressure in tank.
- Do not overfill fuel tank. Gasoline may expand during operation. Do not fill to the top of the tank. Allow for expansion.
- Always check for spilled fuel before operating.
- Empty fuel tank before storing or transporting the generator.



WARNING: This generator produces powerful voltage, which can result in electrocution.

ALWAYS ground the generator before using it (see the "Ground the Generator" portion of the "GENERATOR PREPARATION" section).

Generator should only be plugged into electrical devices, either directly or with an extension cord.

NEVER connect to a building electrical system without a qualified electrician. Such connections must comply with local electrical laws and codes. Failure to comply can create a back-feed, which may result in serious injury or death to utility workers.

- Use a ground fault circuit interrupter (GFCI) in highly conductive areas such as metal decking or steel work. GFCIs are available in-line with some extension cords.
- Do not use in rainy conditions.
- Do not touch bare wires or receptacles (outlets).

Do not allow children or non-qualified persons to operate.



WARNING: This generator produces heat when running. Temperatures near exhaust can exceed 150°F (65° C).

Do not touch hot surfaces. Pay attention to warning labels on the generator identifying hot parts of the machine.

Allow generator to cool down after use before touching engine or areas of the generator that become hot during use.

CAUTION: Misuse of this generator can damage it or shorten its life.

Only use generator for its intended purposes.

Operate only on dry, level surfaces.

Allow generator to run for several minutes before connecting electrical devices.

Shut off and disconnect any malfunctioning devices from generator.

Do not exceed the wattage capacity of the generator by plugging in more electrical devices than the unit can handle.

Do not turn on electrical devices until after they are connected to the generator.

Turn off all connected electrical devices before stopping the generator.

Turn the engine switch to “OFF” position when the engine is not running.

IMPORTANT SAFETY INSTRUCTIONS

SAVE THESE INSTRUCTIONS – This manual contains important instructions for the PowerSmart® 2500W generator that should be followed during installation and maintenance of the generator.

Generators vibrate in normal use. During and after the use of the generator, inspect both the generator as well as extension and power supply cords for damage resulting from vibration. Have damaged items repaired or replaced as necessary. Do not use plugs or cords that show signs of damage such as broken or cracked insulation.

For power outages, permanently installed stationary generators are better suited for providing backup power to the home. Even a properly connected portable generator can become overloaded. This may result in overheating or stressing of the components, possibly leading to a generator failure.



WARNING: If this generator is used as a supply for a building’s wiring system, the generator must be installed by a qualified electrician and connected to a transfer switch as a separately derived system in accordance with the National Electrical Code, NFPA 70. The generator shall be connected to a transfer switch that switches all conductors excluding the equipment grounding conductor. The frame of the generator shall be connected to an approved grounding electrode.

KNOWING YOUR GENERATOR

Use the illustrations below to become familiar with the locations and functions of the various components and controls of this generator.

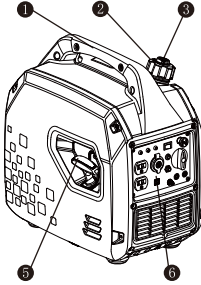

- ① Carrying handle
- ② Fuel tank cap
- ③ Ventilation knob
- ④ Spark plug maintenance cover
- ⑤ Recoil starter

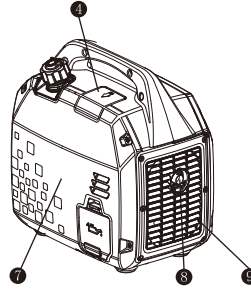

- ⑥ Control Panel
- ⑦ Appearance cover
- ⑧ Muffler
- ⑨ Muffler blind window

Control Panel

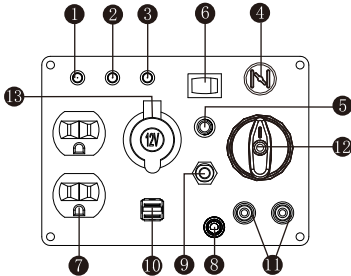

- ① Running indicator
- ② Overload indicator
- ③ Oil alarm lamp
- ④ Choke lever
- ⑤ Reset button
- ⑥ Energy-saving switch
- ⑦ AC output receptacle
- ⑧ Ground terminal
- ⑨ DC Circuit breaker
- ⑩ USB port
- ⑪ Parallel kit terminal
- ⑫ Two-in-one switch (engine stop & fuel switch)
- ⑬ 12V DC

GENERATOR PREPARATION

The following section describes steps necessary to prepare the generator for use. If after reading this section, you are unsure about how to perform any of the steps please call **(800) 791-9458 & (888)293-0024 Mon-Fri 9-5 EST** for customer service. Failure to perform these steps properly can damage the generator or shorten its lifespan.

Unpacking

Unpack the generator and all its parts. Do not discard the carton or any packaging until the generator is completely assembled.

Step 1 - ADD OIL



This engine is not filled with oil before send out to the factory. User must add the proper amount of oil before operating the generator for the first time. Any attempt to crank or start the engine before it has been properly filled with the recommended type and amount of oil may result in engine damage and void your warranty.

The oil capacity of the engine crankcase is 16.9 fl.oz. For general use (above 40° F), we recommend 10W30, 4-stroke engine oil.

ENGINE OIL RECOMMENDATIONS

Select good quality detergent oil bearing the American Petroleum Institute (API) service classifications SJ, SL, or SM (synthetic oils may be used). Use the ASE viscosity grade of oil from the following chart that matches the starting temperature anticipated before the next oil changes.

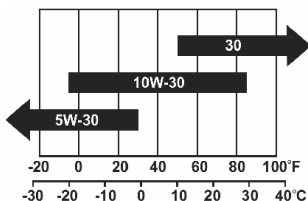

Engine Oil Temperature Recommendations

To add oil, follow these steps:

1. Place the engine on a level surface.
2. Remove the dipstick and wipe it clean (see fig.1)
3. Add recommended oil to the upper limit (see fig.2)
4. Fully tighten the dipstick.
5. Properly dispose of any used oil at an approved waste management facility.

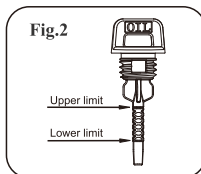
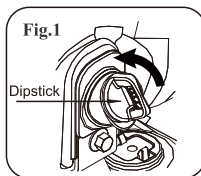

Step 2 - ADD GASOLINE



WARNING: This generator may emit highly flammable and explosive gasoline vapors, which can cause severe burns or even death if ignited. A nearby open flame can lead to explosion even if not directly in contact with gasoline.

Use clean, fresh, regular unleaded gasoline with a minimum octane rating of 87. Do not mix oil with gasoline. Always wipe up any spilled fuel.

To add gasoline, follow these steps:

1. Make sure the generator is on a level surface.
2. Unscrew fuel cap and set aside. **NOTE:** The fuel cap may be tight and hard to unscrew.
3. Slowly add unleaded gasoline to the fuel tank. Be careful not to overfill. The capacity of the fuel tank is 1.06 gallons. **NOTE:** Do not fill the fuel tank to the very top. Gasoline will expand and spill over during use even with the fuel cap in place.
4. Reinstall fuel cap and wipe clean any spilled gasoline with a dry cloth.

IMPORTANT:

- Never use an oil/gasoline mixture.
- Never use old gasoline.
- Avoid getting dirt or water into the fuel tank.
- Gasoline can age in the tank and make starting difficult. Never store generator for extended periods of time with fuel in the tank or the carburetor.
- Turn the fuel cock off and drain the fuel from the carburetor.

Step 3 - GROUND THE GENERATOR



WARNING: Failure to properly ground the generator can result in electrocution.

Ground the generator by tightening the grounding nut (see fig.3) on the front control panel against a grounding wire.

A ground terminal has been provided on the generating set. For remote grounding, connect a length of heavy gauge(4mm) copper wire between the generating set ground terminal and a copper rod driven into the ground. Local electrical codes may also require proper grounding of the unit. We strongly recommend that you consult with a qualified electrician for grounding requirements in your area.

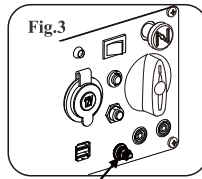

Grounding Terminal

NOTE: After completing the above preparation, the generator is ready to be started.

STARTING THE GENERATOR

Before starting the generator, make sure you have read and performed the steps in the “Generator Preparation” section of this manual. If you are unsure about how to perform any of the steps in this manual, please call (800) 791-9458 & (888)293-0024 Mon-Fri 9-5 EST or email: support@powersmartusa.com & support@amerisuninc.com for customer service.



DANGER: CARBON MONOXIDE.

Using a generator indoors CAN KILL YOU IN MINUTES.

Generator exhaust contains carbon monoxide (CO). This is a poison gas you cannot see or smell. If you can smell the generator exhaust, you are breathing CO. Even if you cannot smell the exhaust, you may be breathing CO.

NEVER use a generator inside homes, garages, crawlspaces, or other partly enclosed areas. Deadly levels of carbon monoxide can build up in these areas. Using a fan or opening windows and doors does NOT supply enough fresh air.

ONLY use a generator outside and far away from windows, doors, and vents. These openings can pull in generator exhaust. Even if you use a generator correctly, CO may leak into the home. **ALWAYS** use a battery-powered or battery-backup CO alarm in the home.

If you start to feel sick, dizzy, or weak after the generator has been running, move to fresh air **RIGHT AWAY**. See a doctor. You may have carbon monoxide poisoning.



WARNING: This generator produces powerful voltage, which can result in electrocution.

ALWAYS ground the generator before using it (see the “Ground the Generator” portion of the “Generator Preparation” section).

- Generator should only be plugged into electrical devices, either directly or with an extension cord. **NEVER** connect to a building electrical system without a qualified electrician. Such connections must comply with local electrical laws and codes. Failure to comply can create a back-feed, which may result in serious injury or death to utility workers.
- Use a ground fault circuit interrupter (GFCI) in highly conductive areas such as metal decking or steel work. GFCIs are available in-line with some extension cords.
- Do not use in rainy or wet conditions.
- Do not touch bare wires or receptacles (outlets).
- Do not allow children or non-qualified persons to operate.

CAUTION: Disconnect all electrical loads from the generator before attempting to start.

STARTING THE ENGINE

To start the generator, perform the following steps:

1. Turn the ventilation knob to “ON” position (see fig.4).
2. Turn the two-in-one switch to the “ON” position (see fig.5).

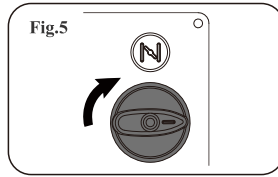
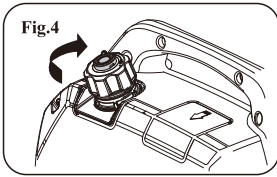

3. Turn the energy saving switch to the “ON” position (see fig.6).
Note: When the energy-saving switch is in “ON” position, the energy saving equipment controls the engine rotate speed according to the connected loads. There will be good fuel consumption and low noise. When the energy-saving switch is in “OFF” position, the engine will always run in rated rotate speed no matter it is connected to the loads or not.

Please set the energy-saving switch to “OFF” position when the load is over 1200W.

4. Pull out the choke lever to close the choke valve (see fig.7)
Choke position for starting may vary depending upon temperature and other factors. If re-starting a warm engine, there is no need to pull out the choke lever.

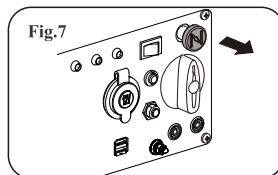
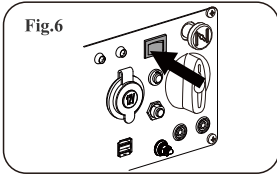

5. Hand recoil starting

When starting engine, grasp the recoil starter handle and pull slowly until resistance is felt. Then pull rapidly to avoid kickback (see fig.8). When pulling the recoil starter, firmly grasp the carrying handle to avoid tumble of generating set.

6. After the engine starts successfully, and the temperature has been increased, push the chock lever to open the choke valve (see fig.9). If the engine runs unstably (shaking exists), push the choke lever to the **HALF** open position. Then push it to the **FULL** open position after engine runs stably.

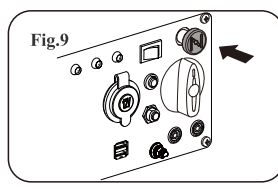
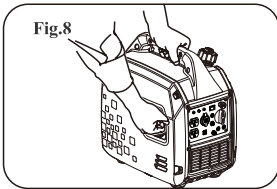

7. After all above operations, the engine can be normally loaded (see fig.10).

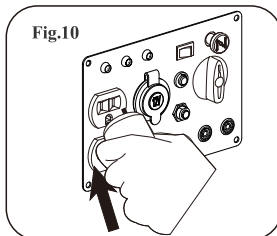

STOPPING THE GENERATOR

TO STOP THE GENERATOR



WARNING: Never stop the engine with electrical devices connected and running.

1. Remove the connectors of all electric equipment from the generating set panel (see fig.11).

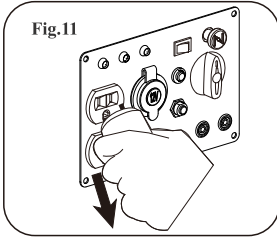

2. Turn the engine saving switch to the “ON” position (see fig.12).

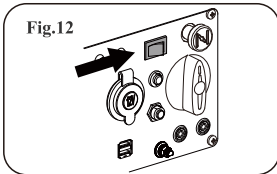

3. Allow the generating set run at no load for a few minutes to stabilize internal temperatures of the engine and generating set.
4. Turn the two-in-one switch to “OFF” position (see fig.13)
When turn the switch to “FUEL OFF” position, engine cannot stop immediately, after the fuel is exhausted the engine stop. When turn the switch to “OFF” position, turn off fuel and stop the engine at the same time.

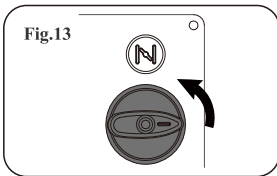

5. Turn the ventilation knob to “OFF” position (see fig.14).

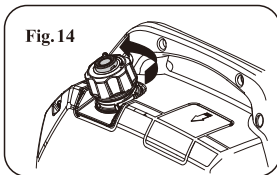

USING THE GENERATOR

CONNECT TO ELECTRICAL DEVICES

1. Inspect power cord for damage before using. There is a hazard of electrical shock from crushing, cutting or heat damage.
2. Make sure that the generating set has been properly grounded. If the electric devices require grounding, the generating set must ground.
3. Allow the engine to stabilize and warm up for a few minutes after starting.
4. Make sure that the electric devices are in “OFF” position.
5. Connect and start the electric devices.
6. Turn off all electric devices and disconnect them from the generating set.
7. If the generating set supplies for several loads or electric devices, start the smallest one first and the largest one last.



DANGER: To reduce the risk of electrical shock, DO NOT use electrical cords that are worn, frayed, bare or otherwise damaged. DO NOT touch bare wires or receptacles. DO NOT handle generating set or electrical cords while standing in water, while barefoot, or while hands or feet are wet.

LOADING CAPACITY



WARNING: Do not overload the generating set. Exceeding the generating set’s capacity can damage the generating set and/or electric devices connected to it.

You must make sure your generating set can supply enough rated (running) and (starting) watts for the electrical devices at the same time. Follow these simple steps to calculate the running and starting watts necessary for your purposes.

1. Count the electrical devices you will power at the same time.
2. The amount of power you need to run with the devices is the total rated (running) watts of these items.
3. Starting power is the power needed shortly when electric devices start. Since not all devices start at the same time, starting power can be estimated by the maximum power of all devices plus the total power counted in step 2.

Electric equipment		Rate power(W)	Starting power(W)
Appliances	Tablet computer27"	80	100
	Energy saving lamp	5-50	5-50
	Electric cooker	1000	1000
	Computer	250	250
	Electric fan	50	100
	Washing machine	250	500
	Refrigerator	50	300
	Air-conditioner	1600	3200
Electric tooling	Electric hammer	1000	1500
	Impact Hammer	3000	6000
	Water pump	2200	5000
	Electric welding machine	5000	7500
	Air compressor	5000	10000

Wattage Reference Chart



CAUTION: When the overload indicator is on, it indicates that the generating set is overload and it may cause overheat of frequency converter, or increase of AC voltage. And then the AC protector works. It will stop the output of generating set to protect the electric equipment and the generating set itself. At this time, the running indicator(green) is off and the overload indicator(red) is on, but the engine is still in running set.

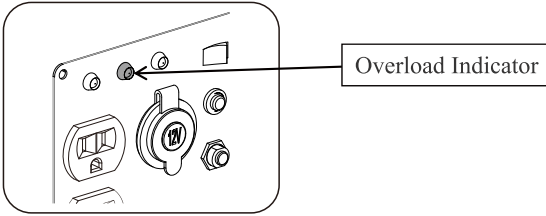

When the generating set has no output and the overload indicator is on, please take the following steps:

1. Lower the total power of connected electric devices to the rated output range of generating set.
2. Check the air intake for impurities and check the control parts for abnormal situation. Handle immediately if necessary.
3. Press the reset button.

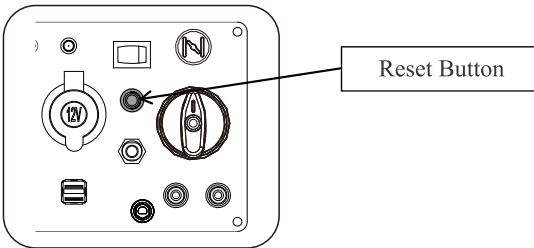

WARNING: It is necessary to equip with circuit protector or switch to isolate the generating set from the electric utility when the generating set is mainly used for backup. Failure to isolate the generating set from the power utility may result in injury or death to electric utility workers and damage to the generating set due to back feed of electrical energy.

PARALLEL OPERATION

Make sure that the generating set is in a good running state before connecting it to other generating sets. The total power of electric devices should not exceed rated power of generating set. When electric motor starts, the overload indicator (red) will light up and normally it will stop within 4 seconds. If it cannot stop, please call **(800) 791-9458 & (888)-293-0024 Mon-Fri 9-5 EST** or email: **support@powersmartusa.com & support@amerisuninc.com** for customer service. During parallel operation, energy-saving switches of generating sets should be in the same position. To parallel operation, perform the following steps:

1. Connect one generating set to other generating set(s) in parallel. Use the parallel kit to make the parallel connection (the parallel kit needs to be purchased separately).
2. Start the engine in proper order and make sure that the running indicator (green) is normal.
3. Connect the plug of electric devices to the AC receptacle of parallel kit.
4. Run the electric devices.



CAUTION: When overload too much, overload indicator (red) blinks continuously, and the generating set may be damaged. When overload a little, overload indicator (red) lights up continuously, it may shorten the service life of generating set. When continuously operating the generating set, power cannot exceed the rated power of generating set.

The total power of electric devices cannot exceed the rated power of generating set. The manufacturers of electric devices or tools always list the rated power of similar models or serial number.

MAINTENANCE

Proper routine maintenance of the generator will help prolong the life of the machine. Please perform maintenance checks and operations according to the schedule in below chart.

		Each time before use	The first month or 10 hours <small>note2</small>	Every three months or 50 hours <small>note2</small>	Every six months or 100 hours <small>note2</small>	Every year or 300 hours <small>note2</small>
Engine oil	Inspection	√				
	Replacement		√		√	
Air filter	Inspection	√				
	Cleaning			√ <small>note3</small>		
Spark plug	Inspection and adjustment				√	
	Replacement					√
Spark Extinguisher <small>note1</small>	Cleaning				√	
Idle speed	Inspection and adjustment					√ <small>note4</small>
Valve clearance	Inspection and adjustment					√ <small>note4</small>

NOTE:

Note1: Applicable types (if available).

Note2: Before each season and after then (whichever comes first).

Note3: Service more frequently under severe, dusty, dirty conditions.

Note4: To be performed by knowledgeable, experienced owners or the authorized dealer.

GENERATOR MAINTENANCE



WARNING: Never clean the generator when it is running! Never use water to clean the generating set. Water can enter the generating set through the cooling slots and damage the generating set windings.

Do not modify the generating set in any way.

Do not tamper with modified the speed regulator. Generating set supplies correct rated frequency and voltage when running at factory set. Tampering with modify the factory set governor will void your warranty.

Always try to use the generator in a cool, dry place. If the generator becomes dirty, clean the exterior with a damp cloth, a soft brush, a vacuum or pressurized air.

Use a damp cloth to clean exterior surfaces of the generating set. Use a soft brush to clean the dirt and oil. Use an air compressor (25 PSI) to clear dirt and debris from the generating set. Inspect all air vents and Cooling slots to ensure that they are clean and unobstructed.

ENGINE MAINTENANCE

CHECKING THE OIL

The oil capacity of the engine crankcase is 16.9 fl. oz.

1. Place the engine on a level surface with engine stopped. Check the engine oil level. Remove the oil maintenance cover. Remove the dipstick and wipe it clean.
2. Reinstall dipstick into hole, rest on oil fill neck, DO NOT thread cap into hole.
3. Remove the dipstick again and check oil level. Level should be between the upper and lower limit. Fill to the upper limit of the dipstick with the recommended oil if the oil level is too low.
4. Reinstall and fully tighten the dipstick.

CHANGING OIL

1. Place the machine on a level surface which is 300mm higher than the ground.
2. Remove the oil maintenance cover.
3. Place the waste oil box on the ground.
4. Remove the oil dipstick, and tilt the machine to pour the oil.
5. Add recommended oil to the upper limit.
6. Fully tighten the dipstick.
7. Properly dispose of any used oil at an approved waste management facility.
8. Reinstall the oil maintenance cover.

AIR CLEANER MAINTENANCE

Routine maintenance of the air cleaner helps maintain proper airflow to the carburetor. Occasionally check that the air cleaner is free of excessive dirt.

1. Remove the appearance cover.
2. Loosen the filter fix clamp and remove the cover of air filter.
3. Remove the foam filter element.
4. Wash in liquid detergent and warm water.
5. Squeeze thoroughly dry in a clean cloth.

6. Saturate in clean engine oil.
7. Squeeze in a clean absorbent cloth to remove all excess oil.
8. Assemble the filter element onto the filter unit.
9. Assemble the filter fix clamp.
10. Reinstall the appearance cover.

CAUTION: DON NOT run the engine without the air filter, or serious danger can result.

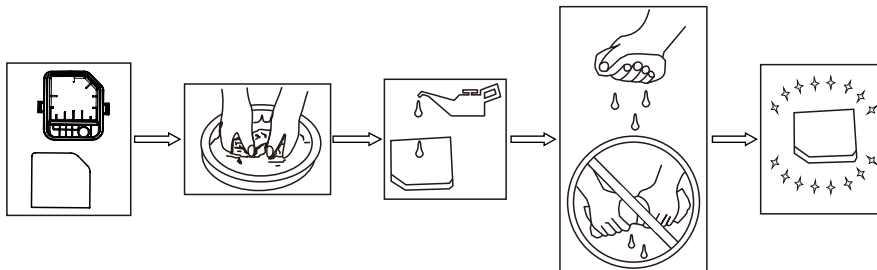

SPARK PLUG MAINTENANCE

Spark plug gap : 0.6mm-0.8mm(0.024-0.031 in).

Spark plug tighten torque: 15-20N.m

The spark plug is important for proper engine operation. A good spark plug should be intact, free of deposits, and properly gapped. Refer to Recommended Maintenance Schedule. To inspect the spark plug:

1. Clean any dirt from the spark plug base.
2. Remove the spark plug cap.
3. Using socket wrench to loose and remove the spark plug.
4. Inspect the spark plug and spark plug washer, if it was broken or worn, replace with a new one. Clean the spark plug with wire brush if reuse it.
5. Check spark plug gap. Carefully bend side electrode to adjust the gap if necessary.
6. Carefully thread the plug into the engine by hand.
7. After the spark plug is seated, use spark plug wrench to tighten the plug.
8. Attach the spark cap to the plug and connect the spark plug wire to the plug.

CAUTION: Only use recommended spark plug or equivalent. Do not use spark plugs that have improper heat range.

SPARK ARRESTER

1. Allow the generating set to cool completely before servicing the spark arrester.
2. Remove the muffler blind window first.
3. Remove the spark arrester screen.
4. Carefully remove the carbon deposits from the spark arrester screen with a wire brush.
5. Replace the spark arrester if it is damaged.
6. Reinstall the spark arrester in the muffler and reinstall the muffler blind window.

STORAGE & TRANSPORT PROCEDURES

STORAGE

The generating set should be started at least once every 2 weeks and allowed to run for at least 20 minutes. Follow the instructions below for longer term storage if the generating set will be out of service for 2 months or more.

- Allow the generating set to cool completely before storage.
- Clean the generating set according to instruction in maintenance section.
- Drain all fuel completely from the fuel tank, fuel hose and carburetor to prevent gum from forming.
- Close the fuel switch to cut down fuel supply.
- Remove the appearance cover plate. Unscrew the oil dipstick and slightly tilt the whole set to pour out the oil.
- Remove the spark plug and pour about 15ml of oil into the cylinder. Pull the recoil starter slightly to distribute the oil and lubricate the cylinder. And then attach the spark plug.
- Store the unit in a clean, dry area out of direct sunlight.

TRANSPORT

To prevent fuel spillage when transporting or during temporary storage, the generating set should be secured upright in its normal operating position, with the engine switch OFF. The two-in-one switch should be turned OFF.

TROUBLESHOOTING

Failure	Problem	Solution
Generating set fails to start	Two-in-one switch is in "OFF" position	Turn two-in-one switch to the "RUN" position.
	Lack of fuel	Add fuel.
	Lack of engine oil	Check oil level. This engine is equipped with a low oil sensor. This engine cannot be started unless the oil level is above the prescribed lower limited. Add the oil per instructions in this manual in page 16.
	No ignition	Remove the spark plug cap. Clean any dirty around the plug base, and then remove the spark plug. Install the spark plug in the plug cap. Turn the two-in-one switch to "RUN" position. Grounding the electrode to any engine ground, pull the recoil starter to see if sparks jump across the gap. If there is no spark, replace the plug. Reinstall the plug and start engine according to instructions in this manual in page17.
	Spark plug is splashed by fuel	Remove the spark plug and wipe the fuel.
	Engine is filled with contaminated or old fuel	Drain fuel in the tank. Fill with fresh fuel.
	Spark plug is broken	Replace the spark plug.
	The generating set flames out after running for a certain time	Turn the ventilation knob on the fuel tank cap to "ON" position. Check the fuel and oil level. Add them if necessary.

Failure	Problem	Solution
Generator runs but there is no output	Circuit breaker has been tripped due to overload	Reset circuit breakers per instructions in this manual in page 14.
	Bad connecting cords or wires	Check the cord sets and extension cords. Do not use if any cord is damaged. Replace damaged cords immediately.
	Bad electrical device connected to the generator	Check the electrical device and try connecting a different device.
Generator runs but does not support all electrical devices connected	Generator is overloaded	Turn off and unplug all electrical devices. Wait 5 minutes, then press the circuit breaker to reset. Reduce load as necessary, then plug devices back in one by one.
	Short circuit in one of the devices	Try disconnecting any faulty or short-circuited electrical loads.
	Air filter is dirty	Clean or replace the air filter element.
Engine is "Hunting" during Operation (Engine RPM is fluctuating).	<ol style="list-style-type: none"> 1. The fuel isn't running through the fuel valve. 2. The air filter is clogged. 3. The muffler or spark arrester is blocked. 4. There is gunk in the carburetor preventing a consistent fuel/air mixture. 	<p>Turn off the generator and wait for it to cool down. Perform the following steps:</p> <ol style="list-style-type: none"> 1. Check if the fuel is properly and consistently going through the fuel valve. 2. Check for any blockage in the air filter. Check and clean the air filter as necessary. 3. Check if the spark arrester is blocked. Clean with metal brush as necessary. 4. Use "gunk remover" spray on the carburetor jets.

WIRING DIAGRAM

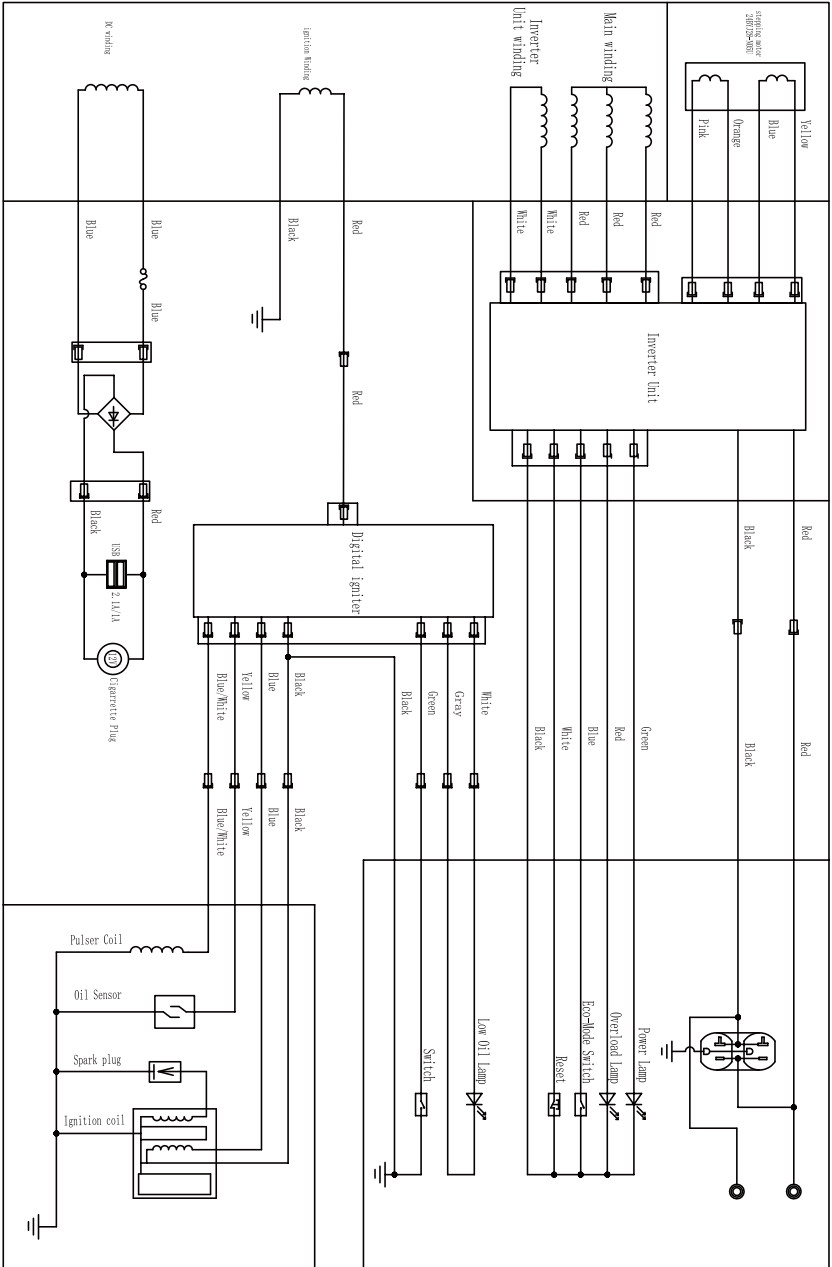

EXPLODED VIEW & PARTS LIST

Engine exploded view

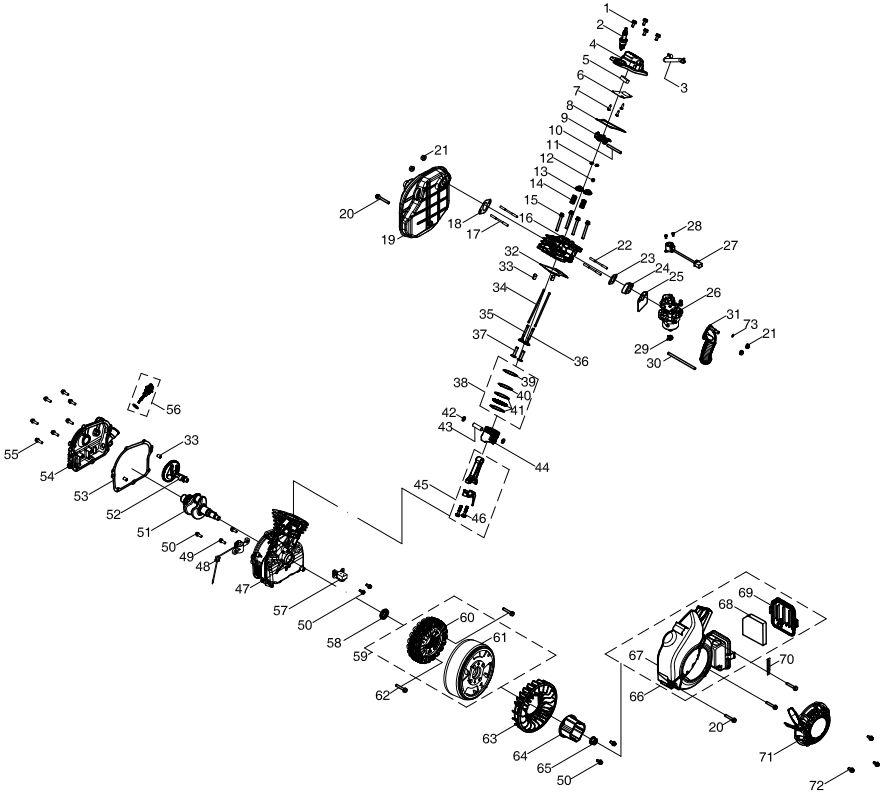

Engine parts list

Part#	Stock#	Description	Qty.
1	100033099-0006	Bolt, M6×18	4
2	100009386	Spark Plug	1
3	100088413	Breather Hose	1
4	100072876	Valve Cover Assembly	1
5	100085696	Breather Filter Screen	1
6	100085695	Inner Cover, Valve Cover	1
7	100005133	Screw, M3×6.5	3
8	100075052	Gasket, Valve Cover	1
9	100075054	Rocker Arm Assembly	2
10	100075053	Rocker Arm Coreshaft	1
11	100075055	Valve Locker	2
12	100075058	Intake Valve Seal	1
13	100075056	Valve Spring Seat	2
14	100159357	Valve Spring	2
15	100011275-0002	Bolt, M6×60	4
16	100148916	Cylinder Head	1
17	100088412	Stud, M6×73	2
18	100075043	Gasket, Muffler	1
19	100096944	Muffler Guard	1
20	100011277-0001	Bolt, M6×60	4
21	100011452-0003	Nut, M6	4
22	100010348	Stud, M6×87	2
23	100075050	Gasket, Carburetor	1
24	100075049	Insulator	1
25	100075048	Gasket, Carburetor Insulator	1
26	100159122	Carburetor	1
27	100061512	Stepping Motor	1
28	100051029-0002	Screw, M4×6	2
29	100005149	Clamp	1
30	100087351	Fuel Hose	1
31	100075035	Intake Manifold	1
32	100085694	Gasket, Cylinder Head	1
33	100010549	Pin, φ8×12	4
34	100075061	Push Rod	2
35	100075059	Exhaust Valve	1
36	100159354	Intake Valve	1
37	100075036	Tappet	2
38	100075040	Piston Ring Set	1
39	100088147	Piston Ring, 1st	1
40	100088148	Piston Ring, 2nd	1
41	100088146	Oil Ring	1
42	100075038	Circlip	2
43	100075039	Piston Pin	1
44	100159355	Piston	1
45	100075037	Connecting Rod Assembly	1
46	100091043	Connecting Rod Bolt	2
47	100085410	Crankcase	1
48	100075063	Oil Sensor	1
49	100031967-0007	Bolt, M6×16	2
50	100011570-0001	Bolt, M6×12	5
51	100065663	Crankshaft	1
52	100159356	Camshaft	1
53	100075062	Gasket, Crankcase	1
54	100072617	Crankcase Cover	1

Part#	Stock#	Description	Qty.
55	100031968-0002	Bolt, M6×20	7
56	100084322-0001	Dipstick	1
57	100092649	Trigger	1
58	100085697	Oil Seal, φ20×φ32×6	1
59	100159546	Alternator	1
60	100159545	Stator Assembly	1
61	100085871	Alternator	1
62	100011223-0001	Bolt, M6×32	2
63	100072871	Cooling Fan	1
64	100072872	Starter Cup	1
65	100033063-0001	Nut, M12×1.25	1
66	100072873	Recoil Starter	1
67	100085054	Blower Housing	1
68	100075483	Air Filter Element	1
69	100075482	Air Filter Cover	1
70	100000655	Clip	1
71	100096833	Recoil Starter	1
72	100011571-0001	Bolt, M6×14	3
73	100005150	Clamp	1

Generator exploded view

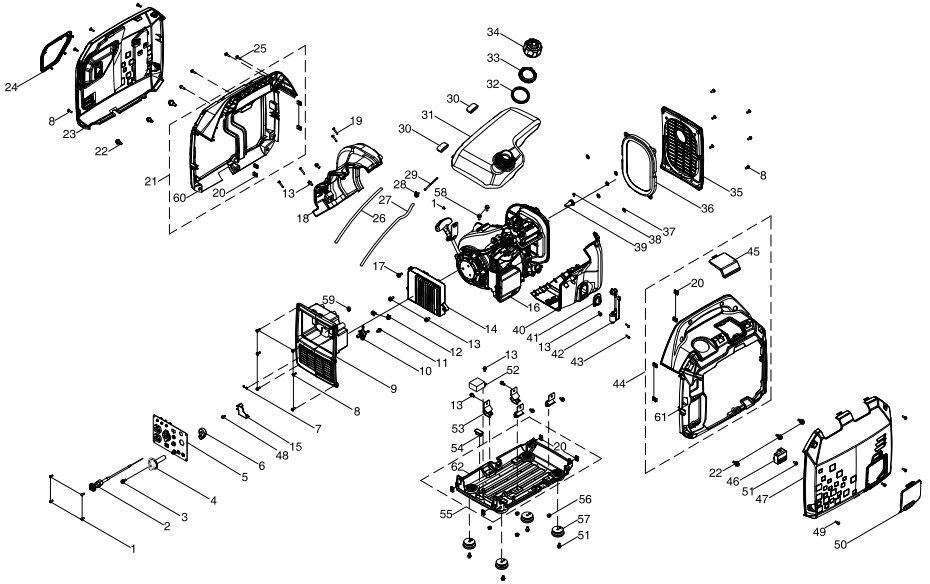

Generator parts list

Part#	Stock#	Description	Qty.	Part#	Stock#	Description	Qty.
1	100010946-0001	Screw, M4×10	5	52	100124948	Rectifier	1
2	100074968	Throttle Cable	1	53	100072715	Damping Pad	4
3	100095857-0005	Bolt, M4×18	1	54	100072710	Damping Pad	1
4	100072724-0003	Fuel Switch Lever	1	55	100088546	Switch Box Base	1
5	100095692-0006	Control Panel	1	56	100011452-0003	Nut, M6	4
6	100083841	Main Shaft Slide	1	57	100072712	Rubber Cap	4
7	100091757	Bearing Clamp Ring	2	58	100033099-0006	Bolt, M6×18	2
8	100081995	Bolt	16	59	100000671	Clip	1
9	100136366-0001	Left Hull	1	60	100139137	Left Hull	1
10	100126150	Fuel Switch	1	61	100139138	Right Hull	1
11	100011571-0001	Bolt, M6×14	1	62	100072711	Switch Box Base	1
12	100005149	Clamp	2				
13	100011570-0001	Bolt, M6×12	10				
14	100160803	Inverter	1				
15	100714558	Block	1				
16	1ZZDDF220	Engine	1				
17	100011249-0003	Bolt, M5×12	1				
18	100072874	Cylinder Head Baffle	1				
19	100011004-0001	Self-tapping Screw, ST4.2×25	4				
20	100050562	Fuel Tank Mount Thread Tab	12				
21	100092440-0007	Left Hull	1				
22	100081994	Alignment Bolt	6				
23	100097032-0010	Left Cover Board	1				
24	100097035-0001	Appearance Protect	1				
25	100033079-0003	Screw, M5×16	4				
26	100131884	Fuel Hose Jacket	1				
27	100131883	Fuel Hose	1				
28	100090871	Clamp	1				
29	100009020	Fuel Filter	1				
30	100072727	Damping Pad	2				
31	100087371	Fuel Tank	1				
32	100073150	Damping Pad	1				
33	100008887	Nut	1				
34	100072726-0003	Fuel Cap	1				
35	100072721-0001	Service Window	1				
36	100072722	Gasket, Muffler	1				
37	100087972	Bearing Clamp Ring	5				
38	100011000-0001	Self-tapping Screw, ST4.2×9.5	1				
39	100085794	Spark Arrester	1				
40	100072875	Cylinder Head Baffle	1				
41	100072878	O-Ring, Dipstick	1				
42	100075041	Ignition Coil	1				
43	100093250-0005	Self-tapping Screw, ST4.8×20	2				
44	100092441-0007	Right Hull	1				
45	100092444-0005	Service Window	1				
46	100087971	Ignition Module	1				
47	100097033-0010	Right Cover Board	1				
48	100011001-0004	Self-tapping Screw, ST4.2×10	1				
49	100134524	Phillips Bolt	4				
50	100092445-0005	Oil Window	1				
51	100011261-0004	Bolt, M6×12	5				

THREE (3) YEARS LIMITED WARRANTY

PowerSmart is committed to building tools that are dependable for years. Our warranties are consistent with our commitment and dedication to quality.

THREE (3) YEARS LIMITED WARRANTY OF POWER SMART PRODUCTS FOR HOME USE.

PowerSmart ("Seller") warrants to the original purchaser only, that all PowerSmart consumer power tools will be free from defects in material or workmanship for a period of three (3) years from date of purchase. Ninety (90) days for all PowerSmart Products, if the tool is used for professional or commercial use.

SELLER'S SOLE OBLIGATION AND YOUR EXCLUSIVE REMEDY under this Three (3) Years Limited Warranty and, to the extent permitted by law, any warranty or condition implied by law, shall be the repair or replacement of parts, without charge, which are defective in material or workmanship and which have not been misused, carelessly handled, or misrepaired by persons other than Seller or Authorized Service Center. To make a claim under this Limited Warranty, you must return the entire power tool product; transportation prepaid, to PowerSmart Include a legible copy of the original receipt, which lists the date of purchase (month and year) and the name of the company purchased from.

THIS LIMITED WARRANTY DOES NOT APPLY TO ANY ACCESSORY ITEMS INCLUDED WITH THE TOOL SUCH AS CIRCULAR SAW BLADES OTHER RELATED ITEMS OR TO ANY REPLACEMENT PARTS LISTED UNDER MAINTENANCE.

ANY IMPLIED WARRANTIES SHALL BE LIMITED IN DURATION TO THREE (3) YEARS FROM DATE OF PURCHASE. SOME STATES IN THE U.S. AND SOME CANADIAN PROVINCES DO NOT ALLOW LIMITATIONS ON HOW LONG AN IMPLIED WARRANTY LASTS, SO THE ABOVE LIMITATION MAY NOT APPLY TO YOU.

IN NO EVENT SHALL SELLER BE LIABLE FOR ANY INCIDENTAL OR CONSEQUENTIAL DAMAGES (INCLUDING BUT NOT LIMITED TO LIABILITY FOR LOSS OF PROFITS) ARISING FROM THE SALE OR USE OF THIS PRODUCT. SOME STATES IN THE U.S. AND SOME CANADIAN PROVINCES DO NOT ALLOW THE EXCLUSION OR LIMITATION OF INCIDENTAL OR CONSEQUENTIAL DAMAGES, SO THE ABOVE LIMITATION OR EXCLUSION MAY NOT APPLY TO YOU.

THIS LIMITED WARRANTY GIVES YOU SPECIFIC LEGAL RIGHTS, AND YOU MAY ALSO HAVE OTHER RIGHTS WHICH VARY FROM STATE TO STATE IN THE U.S., PROVINCE TO PROVINCE IN CANADA AND FROM COUNTRY TO COUNTRY.

For questions / comments, technical assistance or repair parts –
Please call toll free at: **1-800-791-9458 & 1-888-293-0024** M-F 9am – 5pm EST
Email: support@powersmartusa.com & support@amerisuninc.com

SAVE YOUR RECEIPTS. THIS WARRANTY IS VOID WITHOUT THEM.

