

---

## USER MANUAL

### Portable Air Conditioner

---

Rated voltage: 115V  
Frequency: 60Hz

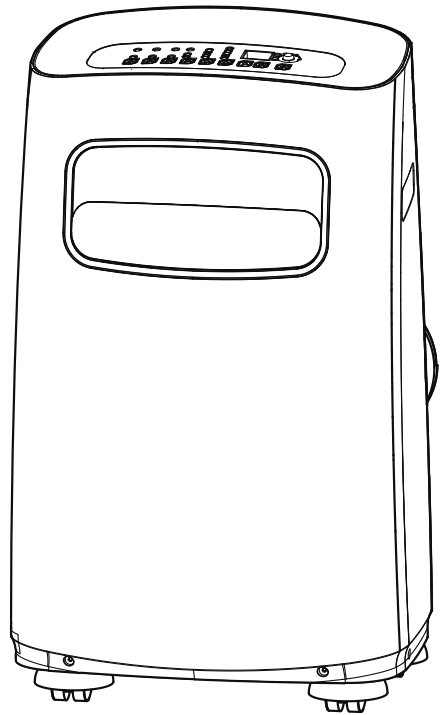

---

Warning notices: Before using this product, please read this manual carefully and keep it for future reference.

The design and specifications are subject to change without prior notice for product improvement. Consult with your dealer or the manufacturer for details.

**PAP10R1BWT**  
**PAP12R1BWT**  
**PAP14R1BWT**

---

**Customer service: 1(866)-646-4332**  
**[www.pelonis.com](http://www.pelonis.com)**

**Safety Precautions ..... 3**

**Unit Specifications and Features ..... 6**

**Operating Instructions ..... 7**

**Installation Instructions ..... 12**

**Care and Cleaning ..... 17**

**Troubleshooting Tips ..... 18**

**Remote Control Instructions ..... 19**

**Warranty ..... 28**

## **Read This Manual**

Inside you'll find many helpful hints on how to use and maintain your air conditioner properly. Just a little preventive care on your part can save you a great deal of time and money over the life of your air conditioner. You'll find many answers to common problems in the chart of troubleshooting tips - you should be able to fix most of them quickly before calling service. These instructions may not cover every possible condition of use, so common sense and attention to safety is required when installing, operating and maintaining this product.



### **CAUTION**

- Contact an authorized service technician for repair or maintenance of this unit.
- The unit is not designed to be used by young children or people with reduced physical, sensory or mental capabilities without supervision.
- Young children should be supervised to ensure that they do not play with the unit.
- If the power cord needs to be replaced, please contact our consumer service or an authorized technician.
- Electrical installation, if needed, must be performed in accordance to national regulation standards by qualified personnel only.

# Safety Precautions

To prevent injury to the user or personal and property damage, these instructions must be followed. Incorrect operation due to ignoring of instructions may cause harm or damage. The level of risk is shown by the following indications.



WARNING

This symbol indicates the possibility of death or serious injury.



CAUTION

This symbol indicates the possibility of injury or damage to property.



WARNING

This symbol shows that this appliance uses a flammable refrigerant. If the refrigerant is leaked and exposed to an external ignition source, there is a risk of fire.



CAUTION

This symbol shows that the operation manual should be read carefully.



CAUTION

This symbol shows that a service personnel should be handling this equipment with reference to the installation manual.



CAUTION

This symbol shows that information is available such as the operating manual or installation manual.



## WARNING

Please read through these instructions before you start the installation process. Improper installation can cause damage to the unit and/or personal property and can be a personal safety hazard.

- Installation must be performed according to the installation instructions. Improper installation can cause water leakage, electrical shock, or fire.
- Use only the included accessories and parts, and specified tools for the installation. Using non-standard parts can cause water leakage, electrical shock, fire, and injury or property damage.
- Make sure that the outlet you are using is grounded and has the appropriate voltage. The power cord is equipped with a three-prong grounding plug to protect against shock. Voltage information can be found on the side of the unit, behind the grille.
- Install the unit on a flat, sturdy surface. Failure to do so could result in damage or excessive noise and vibration.
- The unit must be kept free from obstruction to ensure proper functioning and to mitigate safety hazards.
- DO NOT modify the length of the power cord or use an extension cord to power the unit. DO NOT share a single outlet with other electrical appliances. Improper power supply can cause fire or electrical shock.

**WARNING**

- DO NOT install your air conditioner in a wet room such as a bathroom or laundry room. Exposure to water can cause electrical components to short circuit.
- DO NOT install the unit in a location that may be exposed to combustible gas, as this could cause fire.
- The unit has wheels to allow it to move. Do not attempt to roll the unit across thick carpet or to roll over objects, as this could cause the unit to tip over.
- DO NOT attempt to operate a unit that has been dropped or damaged.
- DO NOT allow children to play with the air conditioner. Children must be supervised around the unit at all times.
- If the air conditioner is knocked over during use, turn off the unit and unplug it from the main power supply immediately. Visually inspect the unit to ensure there is no damage. If you suspect the unit has been damaged, contact a technician or customer service for assistance.
- In a thunderstorm, the unit should be turned off to avoid damage to the machine due to lightning.

**CAUTION**

- This appliance is not intended for use by persons (including children) with reduced physical, sensory or mental capabilities or lack of experience and knowledge, unless they have been given supervision or instruction concerning use of the appliance by a person responsible for their safety.
- If the power cord is damaged, it must be replaced by the manufacturer, its service agent, or similarly qualified persons in order to avoid a hazard.
- Prior to cleaning or other maintenance, the appliance must be disconnected from the outlet.
- Do not install the appliance in a location that may be exposed to combustible gas. If combustible gas accumulates around the unit, it may cause a fire.
- Do not run the power cord under carpeting. Do not cover cord with throw rugs, runners, or similar coverings. Do not route cord under furniture or appliances. Arrange cord away from traffic areas so it will not be tripped over.
- To reduce the risk of fire or electric shock, do not use this air conditioner with any solid-state speed control device.
- The appliance shall be installed in accordance with national wiring regulations.
- Contact the authorized service technician for repair or maintenance of this unit.
- When there are significant differences between features or operation implied by the remote control illustrations and the actual functions described in the USER MANUAL, please refer to the descriptions in the USER MANUAL.
- Do not mix old and new batteries.
- Do not mix alkaline, standard (carbon-zinc), or rechargeable (ni-cad, ni-mh, etc.) batteries.

# Safety Precautions



## WARNINGS (for using R32 refrigerant only)

- Do not use any means to accelerate the defrosting process or to clean the unit, other than those recommended by the manufacturer.
- Do not use or store the appliance in spaces with potential ignition sources (for example: open flames, an operating gas appliance or an operating electric heater).
- Do not pierce or burn refrigerant tubing. Be aware that refrigerants may not contain an odor.
- Keep ventilation openings clear of obstruction.
- Store the appliance in a way that will prevent mechanical damage from occurring.
- Store the appliance in a well-ventilated area where the room size corresponds to the room area as specified for operation.
- Any person who is involved with working on or breaking into a refrigerant circuit should hold a current valid certificate from an industry-accredited assessment authority, which authorizes their competence to handle refrigerants safely in accordance with an industry recognized assessment specification.
- Servicing shall only be performed as recommended by the equipment manufacturer. Maintenance and repair requiring the assistance of other skilled personnel shall be carried out under the supervision of the person competent in the use of flammable refrigerants.
- Flammable refrigerant (R32) is used within the air conditioner. When maintaining or disposing of the air conditioner, the refrigerant (R32) shall be recovered properly, do not discharge to air directly.



Caution: Risk of fire/  
flammable materials  
(Required for R32/R290 units only)

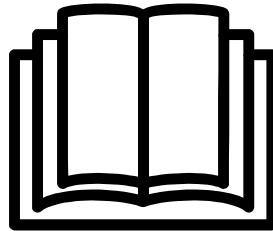

**IMPORTANT NOTE:** Read this manual carefully before installing or operating your new air conditioning unit. Make sure to save this manual for future reference.

# Unit Specifications and Features

## Preparation

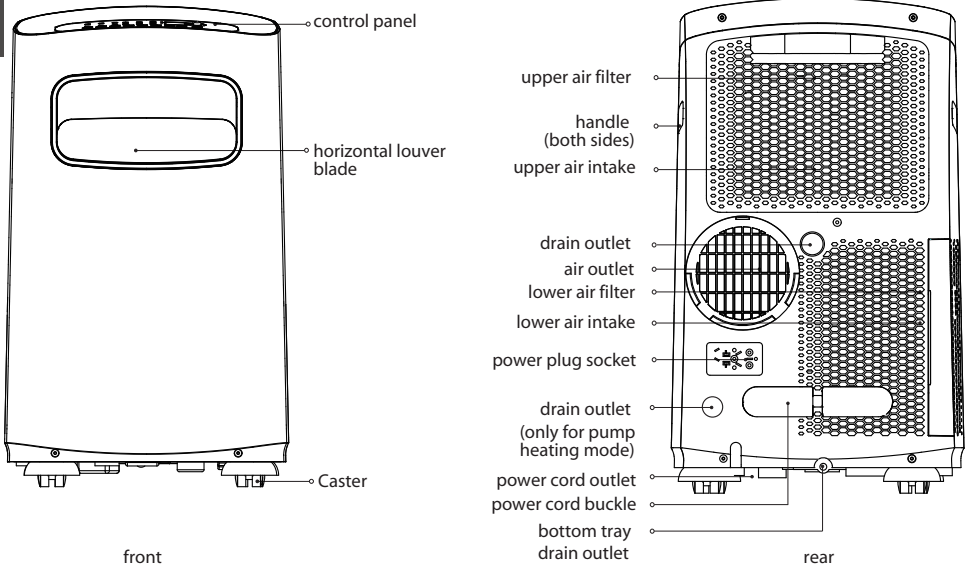

## Design and Compliance Notes

### Design Notice:

In order to ensure the optimal performance of our products, the design specifications of the unit and remote control are subject to change without prior notice.

### Energy Rating Information:

This product is tested in accordance to the DOE SACC capacity energy rating test.

### Unit Temperature Range:

Mode	Temperature Range
Cool	62°F - 95°F (17°C - 35°C)
Dry	55°F - 95°F (13°C - 35°C)
Heat(pump heat mode)	41-86°F (5-30°C )

### The exhaust hose and adapter must be installed or removed according to the desired mode:

The exhaust hose and adaptor must be installed or removed in accordance with the usage mode. For COOL or AUTO mode, exhaust hose must be installed. For FAN or DRY modes, exhaust hose must be removed.

# Operating Instructions

## Control Panel Features



### Swing Button (optional)

(Applicable to the models with auto swing feature only)

Used to initiate the Auto Swing feature. When the operation is ON, pressing the SWING button can stop the louver at the desired angle.

### Timer button

Used to initiate the AUTO ON start time and AUTO OFF stop time program, in conjunction with the + & - buttons. The timer on or off light will illuminate depending on the selected setting.

### Mode button

Selects the desired operating mode. Each time you press the button, a mode is selected in a sequence that goes from AUTO, COOL, DRY FAN and HEAT. The mode light illuminates and indicates the selected mode. (cooling only models excluded)

### Up (+) and Down (-) buttons

Used to adjust (increasing/decreasing) temperature settings in 1°C/1°F increments in a range of 17°C/62°F to 30°C/86°F or the TIMER setting in a range of 0 - 24hrs.

### NOTE

The control is capable of displaying temperature in degrees Fahrenheit or degrees Celsius. To convert from one to the other, press and hold the Up and Down buttons at the same time for 3 seconds.

### Fan/Constant fan

Control the fan speed. Press to select the fan speed in four steps-LOW, MID(MED), HIGH and AUTO. The fan speed indicator light illuminates under different fan settings.

### NOTE

In cooling or Dry mode, press the button for 3 seconds to turn on or off the constant fan function. When the function is turned on, the constant fan light will illuminate, identifying the fan continuous run for cooling. When the function is turned off, the constant fan light will go out, identifying the fan cycle run with compressor stop.

### Sleep/Filter button

Used to initiate the SLEEP operation.

## Control Panel Features (cont.)

### NOTE

After 250 hours of operation, the filter indicator light illuminates. This feature is a reminder to clean the air filter for more efficient operation. Press this button for 3 seconds to cancel the reminder.

### Power button

Power switch on/off.

### LED display

Shows the set temperature in °C or °F and the Auto-timer settings. While on DRY and FAN modes, it shows the room temperature.

Shows Error codes and protection code:

- E1** - Room temperature sensor error.
- E2** - Evaporator temperature sensor error.
- E3** - Condenser temperature sensor error (select models).
- E4** - Display panel communication error.
- P1** - Bottom tray is full -- Connect the drain hose and drain the collected water away. If protection code repeats, call for service.

### NOTE

When one of the above malfunctions occurs, turn off the unit and check for any obstructions. Restart the Unit. If the malfunction persists, turn off the unit and unplug the power cord. Contact the manufacturer, its service agents, or a similarly-qualified person for service



## Operating Instructions

### HEAT operation (Only for heat & cool models)

- Press the "MODE" button until the "HEAT" indicator light comes on.
- Press the ADJUST buttons "+" or "-" to select your desired room temperature. The temperature can be set within a range of 17°C-30°C/62°F-86°F (or 88°F).
- Press the "FAN SPEED" button to choose the fan speed. For some models, the fan speed can not be adjusted under HEAT mode.

### COOL operation

- Press the "MODE" button until the "COOL" indicator light comes on.
- Press the ADJUST buttons "+" or "-" to select your desired room temperature. The temperature can be set within a range of 17°C-30°C/62°F-86°F.
- Press the "FAN SPEED" button to choose the fan speed.

### DRY operation

- Press the "MODE" button until the "DRY" indicator light comes on.
- While in this mode, you cannot select a fan speed or adjust the temperature. The fan motor operates at LOW speed.
- Keep windows and doors closed for the best dehumidifying effect.
- Do not connect the duct to a window.

### AUTO operation

- When you set the air conditioner to AUTO mode, it will automatically select cooling, heating (cooling only models excluded), or fan only operation depending on what temperature you have selected and the current room temperature.
- The air conditioner will control room temperature automatically according to the temperature point set by you.
- Under AUTO mode, you cannot select the fan speed.

### FAN operation

- Press the "MODE" button until the "FAN" indicator light comes on.
- Press the "FAN SPEED" button to choose the fan speed. The temperature cannot be adjusted.
- Do not connect the duct to a window.

### TIMER operation

- When the unit is on, pressing the Timer button will initiate the Auto-off stop program. The TIMER OFF indicator light illuminates. Press the Up or Down button to select the desired time. Press the TIMER button again within 5 seconds. The Auto-on start program is initiated and the TIMER ON indicator light illuminates. Press the up or down button to select the desired Auto-on start time.
- When the unit is off, press the Timer button to initiate the Auto-on start program. Pressing it again within five seconds will initiate the Auto-off stop program.
- Press or hold the Up or Down button to change the Auto time by 0.5 hour increments, up to 10 hours, then at 1 hour increments up to 24 hours. The control will count down the time remaining until start.
- The system will automatically revert back to display the previous temperature setting if there is no operation within 5 seconds.
- Turning the unit ON or OFF at any time or adjusting the timer setting to 0.0 will cancel the Auto Start/Stop timer program.
- Should a malfunction occur, the Auto Start/Stop timed program will be cancelled.

### SLEEP operation

Pressing this button will increase (during cooling operation) or decrease (during heating operation, applicable models) 1°C/1°F after 30 minutes. The temperature will again increase (cooling) or decrease (heating) by another 1°C/1°F after an additional 30 minutes. This new temperature will be maintained for 7 hours before returning to the originally selected temperature. This ends the Sleep mode and the unit will continue to operate as originally programmed.

### NOTE

This feature is unavailable in FAN or DRY mode.

## Other Features

### FOLLOW ME/TEMP SENSING

Feature (optional)

#### NOTE

This feature can be activated from the remote control ONLY. The remote control serves as a remote thermostat allowing for the precise temperature control at its location.

To activate the Follow Me/Temp Sensing feature, point the remote control towards the unit and press the Follow Me/Temp Sensing button. The remote display is actual temperature at its location. The remote control will send this signal to the air conditioner every 3 minutes until the Follow Me/Temp Sensing button is pressed again. If the unit does not receive the Follow Me/Temp Sensing signal for 7 minutes, the unit will beep to indicate the Follow Me/Temp Sensing mode has ended.

### AUTO-RESTART

If the unit shuts off unexpectedly due to a power outage, it will restart with the previously set function automatically when the power resumes.

### WAIT 3 MINUTES BEFORE RESUMING OPERATION

After the unit has stopped, it cannot be restarted until 3 minutes have elapsed. This is to protect the unit. Operation will automatically resume after 3 minutes.

### AIRFLOW DIRECTION ADJUSTMENT

The louver can be adjusted automatically, which also automatically adjusts the airflow direction.

#### NOTE

On some models the louver can be adjusted manually only):

- When the Power is ON, the louver opens fully.
- Press the SWING button on the panel or remote control to initiate the Auto Swing feature. The louver will swing up and down automatically.
- If your unit has these features, please do not adjust the louver manually.
- If your unit does not have these features, the louvers may only be adjusted manually

### Water drainage

- During dehumidifying modes, remove the upper drain plug from the back of the unit and install the drain connector (5/8" universal female mender) with 3/4" hose (locally purchased). For models without drain connector, just attach the drain hose to the hole. Place the open end of the hose directly over the drain area in your basement floor.

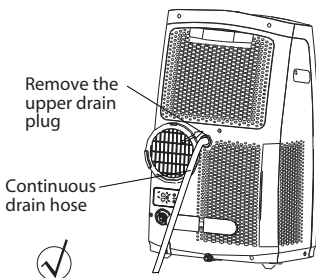

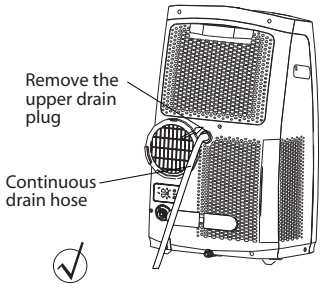

- During heat pump mode, remove the lower drain plug from the back of the unit and install the drain connector (5/8" universal female mender) with 3/4" hose (locally purchased). For models without drain connector, just attach the drain hose to the hole. Place the open end of the hose adaptor directly over the drain area in your basement floor.

**NOTE**

Make sure the hose is secure so there are no leaks. Direct the hose toward the drain, making sure that there are no kinks that will impede water flow. Place the end of the hose into the drain and make sure the end of the hose is directed downward to let the water flow smoothly. (See Figs with ). Installation not recommended. (See Figs with ). When the continuous drain hose is not used, ensure that the corresponding drain plug and knob are installed firmly to prevent leakage.

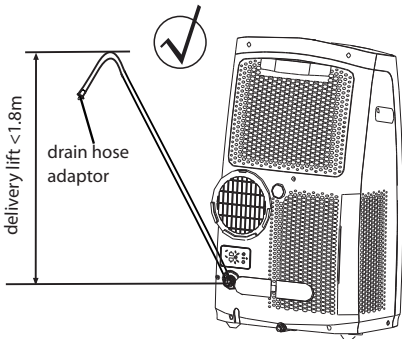

drain hose adaptor

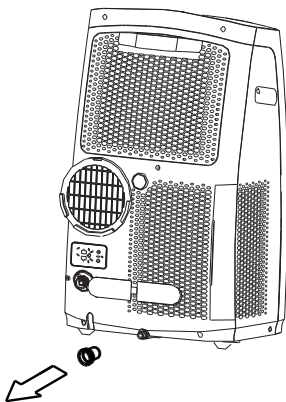
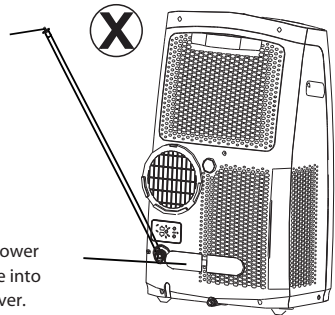

- When the water level of the bottom tray reaches a predetermined level, the unit beeps 8 times. The digital display shows "P1." At this time the air conditioning/ dehumidification process will immediately stop. However, the fan motor will continue to operate (this is normal). Carefully move the unit to a drain location, remove the bottom drain plug and let the water drain away. Reinstall the bottom drain plug and restart the machine until the "P1" symbol disappears. If the error repeats, call for service.

**NOTE**

Be sure to reinstall the bottom drain plug firmly to prevent leakage before using the unit.

# Installation Instructions

## Choosing the Right Location

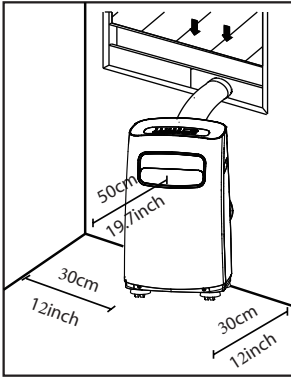

Your installation location should meet the following requirements:

- Make sure that you install your unit on an even surface to minimize noise and vibration.
- The unit must be installed near a grounded plug, and the Collection Tray Drain (found on the back of the unit) must be accessible.
- The unit should be located at least 12" (30 cm) from the nearest wall to ensure proper air conditioning. The horizontal louver blade should be at least 19.7" (50 cm) away from obstacles.
- DO NOT cover the Intakes, Outlets or Remote Signal Receptor of the unit, as this could cause damage to the unit.

## Recommended Installation

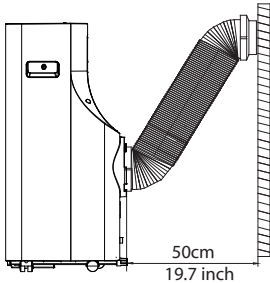

### NOTE

All the illustrations in the manual are for explanation purpose only. Your machine may be slightly different.

The unit can be controlled by the unit control panel alone or with the remote control. See the remote control Instruction for details.

## Note About Fluorinated Gasses











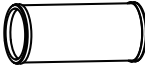

- This air-conditioning unit is a hermetically sealed unit that contains fluorinated gasses. For specific information on the type of gas and the amount, please refer to the relevant label on the unit itself.
- Service, maintenance and repair of this unit must be performed by a certified technician.
- Product recycling must be done according to local regulations.

## Tools Needed

- Medium Phillips screwdriver
- Tape measure or ruler
- Knife or scissors
- Saw (optional, to shorten window adaptor for narrow windows).

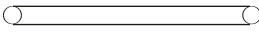
## Accessories

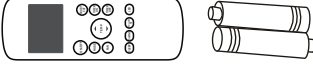
Your Window Installation Kit fits windows 67.5-123 cm (26.5"-48") and can be shortened for smaller windows.

Part	Description	Quantity
	Unit adaptor	1 pc
	Exhaust hose	1 pc
	Window slider adaptor	1 pc
	Bolt	3 pcs
	Window slider A	1 set
	Foam seal A (adhesive)	4 pcs
	Foam seal B (adhesive)	2 pcs
	Foam seal C (Non-adhesive)	2 pcs
	Security bracket and 2 screws	1 set
	Drain hose	1 pc
	Drain hose adaptor (for heat pump mode only)	1 pc
	Remote controller and batteries (For remote control models only)	1 set
	Power Cord Buckle	1 pc

## Window Installation Kit

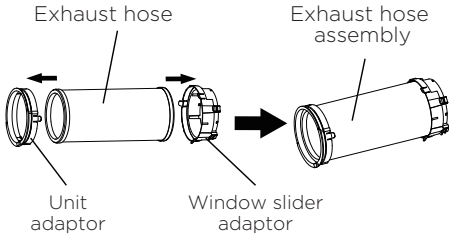

### Step One: Preparing the exhaust hose assembly

Press the exhaust hose into the window slider adaptor and unit adaptor, clamp automatically by elastic buckles of the adaptors.

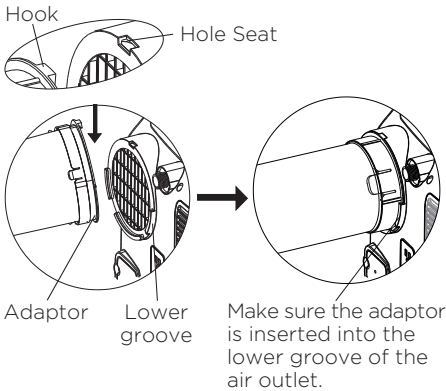

### Step Two: Install the exhaust hose assembly to the unit

Insert unit adaptor of the exhaust hose assembly into the lower groove of the air outlet of the unit with the adaptor hook aligned with the hole seat of the air outlet and slide the exhaust hose assembly down along the direction indicated by the arrow.

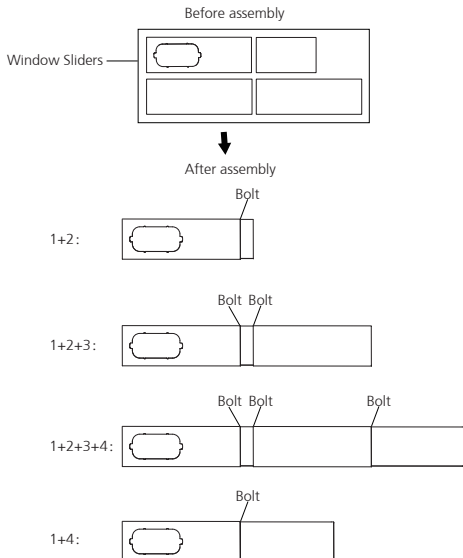

### Step Three: Preparing the Adjustable Window Slider

1. Depending on the size of your window, you may need to adjust the size of the window slider.
2. If the length of the window requires two or three window sliders, use the bolt(s) to fasten the window sliders once they are adjusted to the proper length.

## NOTE

Once the Exhaust Hose assembly and Adjustable Window Slider are prepared, choose from one of the following two installation methods.

Foam seal B  
(Adhesive type-shorter)

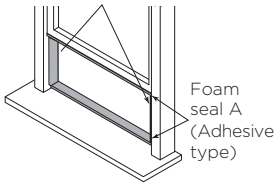

### Type 1: Hung window installation

1. Cut the adhesive foam seal A and B strips to the proper lengths, and attach them to the window sash and frame as shown.

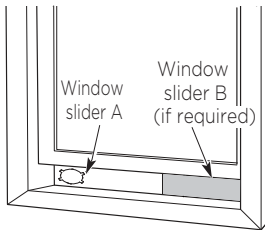

2. Insert the window slider assembly into the window opening.

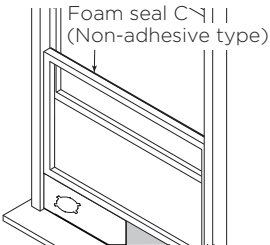

3. Cut the non-adhesive foam seal C strip to match the width of the window. Insert the seal between the glass and the window frame to prevent air and insects from getting into the room.

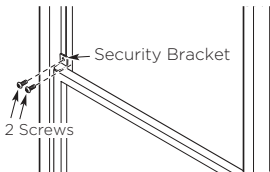

4. If desired, install the security bracket with 2 screws as shown.

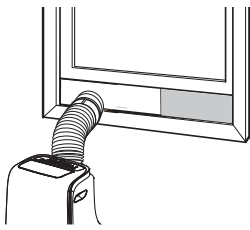

5. Insert the window slider adaptor into the hole of the window slider.

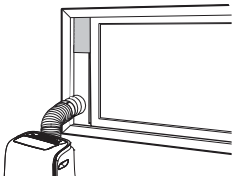
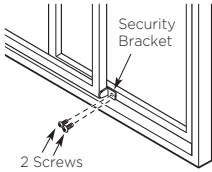
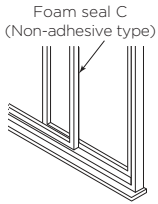
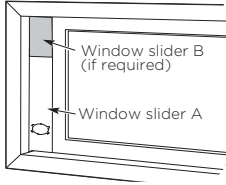
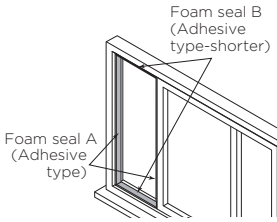

## Type 2: Sliding window installation

1. Cut the adhesive foam seal A and B strips to the proper lengths, and attach them to the window sash and frame as shown.
2. Insert the window slider assembly into the window opening.
3. Cut the non-adhesive foam seal C strip to match the window height. Insert the foam seal between the glass and the window frame to prevent air and insects from getting into the room.
4. If desired, install the security bracket with 2 screws as shown.
5. Insert the window slider adaptor into the hole of the window slider.

### NOTE

To ensure proper functioning, **DO NOT** overextend or bend the hose. Make sure that there is no obstacle around the air outlet of the exhaust hose (in the range of approx. 20 inches) in order for the exhaust system to work properly. All illustrations in this manual are for explanation purposes only. Your air conditioner may be slightly different than the illustrations shown here.





# Care and Cleaning

## Safety Precautions

- Always unplug the unit before cleaning or servicing.
- DO NOT use flammable liquids or chemicals to clean the unit.
- DO NOT wash the unit under running water. Doing so causes electrical danger.
- DO NOT operate the machine if the power supply was damaged during cleaning. A damaged power cord must be replaced with a new cord from the manufacturer.

## Clean the Air Filter

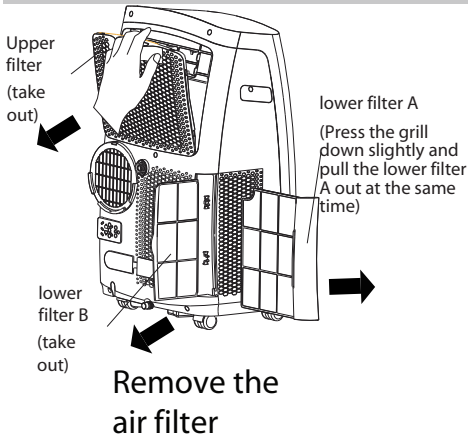

## Maintenance Tips

- Be sure to clean the air filter every 2 weeks for optimal performance.
- The water collection tray should be drained immediately after P1 error occurs, and before storage to prevent mold.
- In households with animals, you will have to periodically wipe down the grill to prevent blocked airflow due to animal hair.

## Clean the Unit

Clean the unit using a damp, lint-free cloth and mild detergent. Dry the unit with a dry, lint-free cloth.

## Store the Unit When Not in Use

- Drain the unit's water collection tray according to the instructions in the following section.
- Run the unit on FAN mode for 12 hours in a warm room to dry it and prevent mold.
- Turn off the unit and unplug it.
- Clean the air filter according to the instructions in the previous section. Reinstall the clean, dry filter before storing.
- Remove the batteries from the remote control.

## NOTE

Be sure to store the unit in a cool, dark place. Exposure to direct sunlight or extreme heat can shorten the lifespan of the unit.

# Troubleshooting Tips

## Malfunction Diagnosis

Please check the following troubleshooting methods before calling for service:

Problem	Possible Cause	Troubleshooting
Unit does not turn on when pressing ON/OFF button	P1 Error Code.	The water collection tray is full. Turn off the unit, drain the water from the water collection tray and restart the unit.
	In COOL mode: room temperature is lower than the set temperature.	Reset the temperature.
Unit does not cool well	The air filter is blocked with dust or animal hair.	Turn off the unit and clean the filter according to instructions.
	Exhaust hose is not connected or is blocked.	Turn off the unit, disconnect the hose, check for blockage and reconnect the hose.
	The unit is low on refrigerant.	Call a service technician to inspect the unit and top off refrigerant.
	Temperature setting is too high.	Decrease the set temperature.
	The windows and doors in the room are open.	Make sure all windows and doors are closed.
	The room area is too large.	Double-check the cooling area.
The unit is noisy and vibrates too much	There are heat sources inside the room.	Remove the heat sources if possible.
	The floor is not level.	Place the unit on a flat, level surface.
The unit makes a gurgling sound	The air filter is blocked with dust or animal hair.	Turn off the unit and clean the filter according to instructions.
	This sound is caused by the flow of refrigerant inside the unit	This is normal.

# Remote Control Instructions

## Remote Control Specifications

Model	RG57H4(B)/BGEFU1
Rated voltage	3.0V (Dry batteries R03/LR03x2)
Signal receiving range	8 m (approx. 26 ft.)
Environment	23°F ~ 140°F (-5°C ~ 60°C)

## Function Buttons

Before you begin using your new air conditioner, make sure to familiarize yourself with its remote control. The following is a brief introduction to the remote control itself. For instructions on how to operate your air conditioner, refer to the Operating Instructions section of this manual.

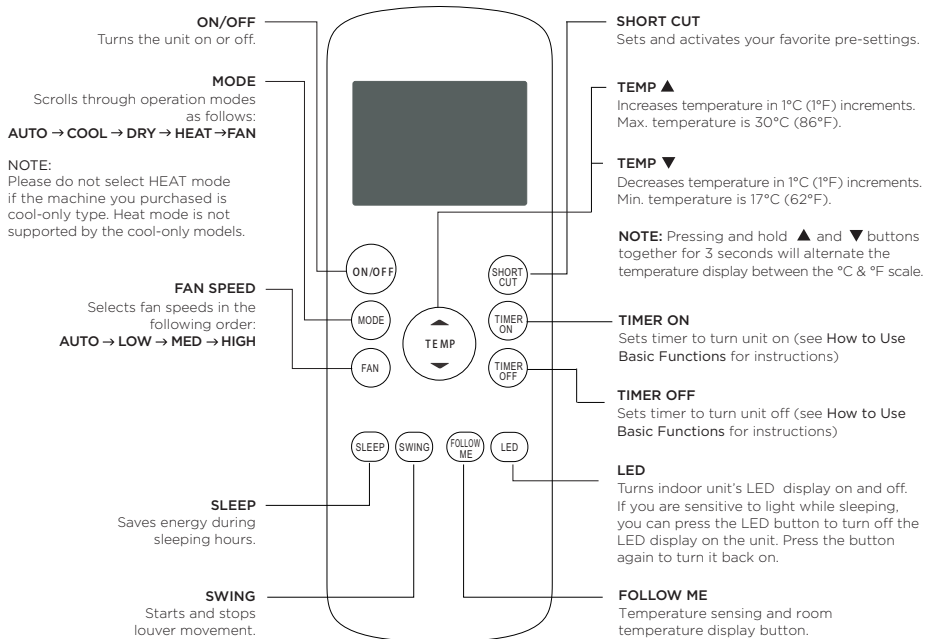

Operating Instructions (With Remote)

## Handling the Remote Control

### NOT SURE WHAT A FUNCTION DOES?

Refer to the Operating Instructions section of this manual for a detailed description of how to use your air conditioner.

### SPECIAL NOTE

Button designs on your unit may differ slightly from the example shown.

If the unit does not have a particular function, pressing that function's button on the remote control will have no effect.

When there are significant differences between features or operation implied by the remote control illustration and the actual functions described in the USER'S MANUAL, please refer to the descriptions in the USER'S MANUAL.

### INSERTING AND REPLACING BATTERIES

Your air conditioning unit comes with two AAA batteries. Insert the batteries in the remote control before use.

1. Slide the back cover of the remote control downward, exposing the battery compartment.
2. Insert the batteries, paying attention to align the (+) and (-) ends of the batteries with the symbols inside the battery compartment.
3. Slide the battery cover back into place.

### BATTERY NOTES

For optimum product performance:

- Do not mix old and new batteries, or batteries of different types.
- Do not leave batteries in the remote control if you don't plan on using the device for more than 2 months.

### BATTERY DISPOSAL

Do not dispose of batteries as unsorted municipal waste. Refer to local laws for proper disposal of batteries.

### TIPS FOR USING REMOTE CONTROL

- The remote control must be used within 8 meters / 26 feet of the unit.
- The unit will beep when remote signal is received.
- Curtains, other materials and direct sunlight can interfere with the infrared signal receiver.
- Remove batteries if the remote will not be used more than 2 months.

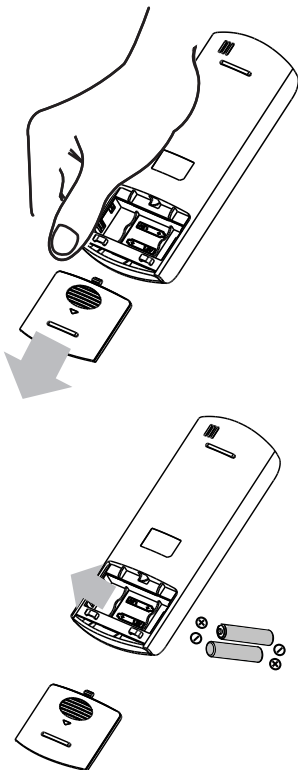

# Remote LED Screen Indicators

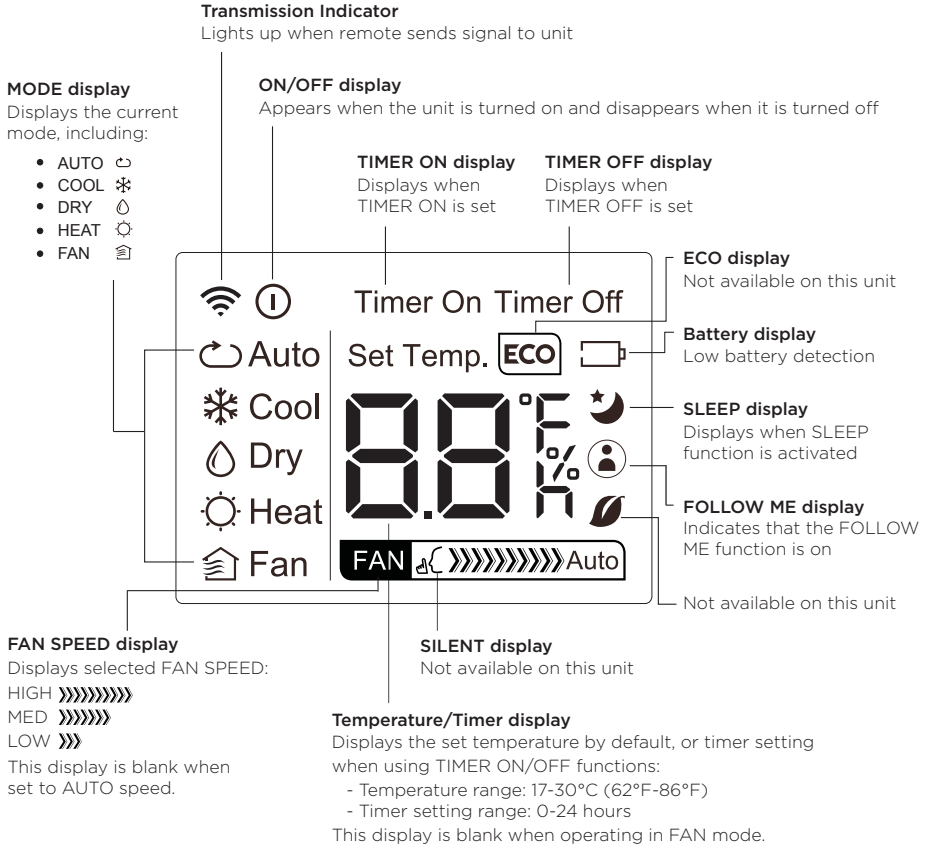

Operating Instructions (With Remote)

## Basic Functions

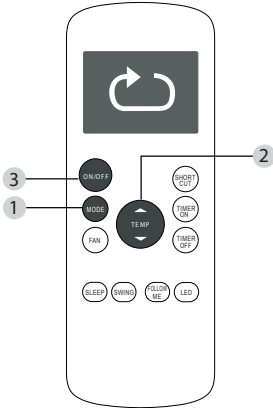

### SETTING THE DESIRED TEMPERATURE

The operating temperature range for this unit is 17-30°C (62°F-86°F). You can increase or decrease the set temperature in 1°C (1°F) increments.

#### AUTO operation

In AUTO mode, the unit will automatically select the COOL, FAN, HEAT or DRY mode based on the set temperature.

1. Press the MODE button to select Auto mode.
2. Set your desired temperature using the Temp ▲ or Temp ▼ button.
3. Press the ON/OFF button to start the unit.

#### NOTE

FAN SPEED cannot be set in AUTO mode.

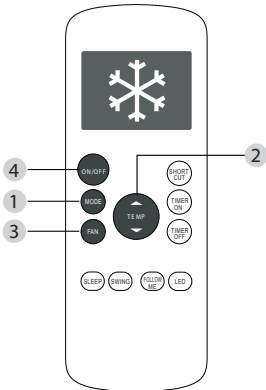

#### COOL operation

1. Press the MODE button to select COOL mode.
2. Set your desired temperature using the Temp ▲ or Temp ▼ button.
3. Press the FAN button to select the fan speed: AUTO, LOW, MED, or HIGH.
4. Press the ON/OFF button to start the unit.

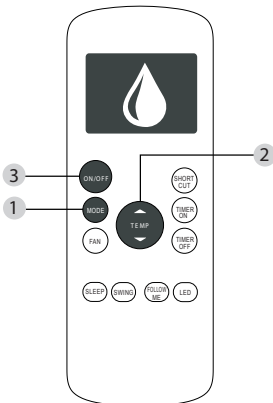

#### DRY operation (dehumidifying)

1. Press the MODE button to select DRY mode.
2. Set your desired temperature using the Temp ▲ or Temp ▼ button.
3. Press the ON/OFF button to start the unit.

#### NOTE

FAN SPEED cannot be set in DRY mode.

## Basic Functions (cont.)

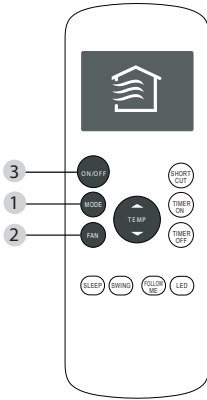

### FAN operation

1. Press the MODE button to select FAN mode.
2. Press FAN button to select the fan speed: AUTO, LOW, MED or HIGH.
3. Press the ON/OFF button to start the unit.

### NOTE

You cannot set temperature in FAN mode. As a result, your remote control's LCD screen will not display temperature.

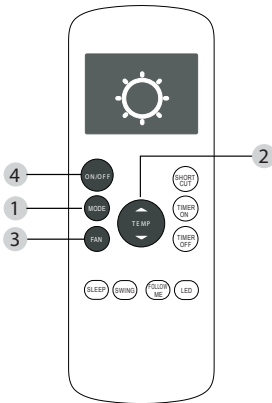

### HEAT operation

1. Press the MODE button to select HEAT mode.
2. Set your desired temperature using the Temp ▲ or Temp ▼ button.
3. Press the FAN button to select the fan speed: AUTO, LOW, MED, or HIGH.
4. Press the ON/OFF button to start the unit.

### NOTE

As outdoor temperature drops, the performance of your unit's HEAT function may be affected. In such instances, we recommend using this air conditioner in conjunction with another heating appliance.

## Timer Functions

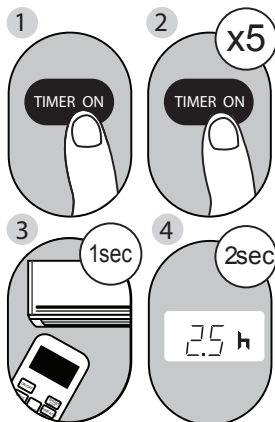

Example: Setting unit to turn on after 2.5 hours.

Your air conditioning unit has two timer-related functions:

**TIMER ON** - sets the amount of time after which the unit will automatically turn on.

**TIMER OFF** - sets the amount of time after which the unit will automatically turn off.

### TIMER ON function

The TIMER ON function allows you to set a period of time after which the unit will automatically turn on, such as when you come home from work.

1. Press the TIMER ON button. By default, the last time period that you set and an "h" (indicating hours) will appear on the display.

#### NOTE

This number indicates the amount of time you want to elapse before the unit turns on. For example, if you set the TIMER ON for 2 hours, "2.0h" will appear on the screen, and the unit will turn on after 2 hours.

2. Press the TIMER ON button repeatedly to set the time that you want the unit to turn on.
3. Wait 2 seconds, then the TIMER ON function will be activated. The digital display on your remote control will then return to the temperature display.

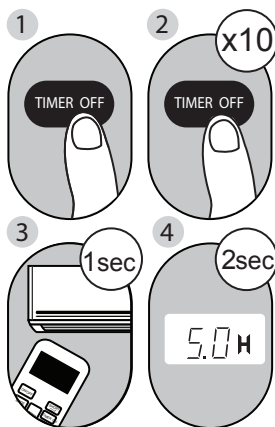

Example: Setting unit to turn off after 5 hours.

### TIMER OFF function

The TIMER OFF function allows you to set a period of time after which the unit will automatically turn off, such as when you wake up.

1. Press the TIMER OFF button. By default, the last time period that you set and an "h" (indicating hours) will appear on the display.

#### NOTE

This number indicates the amount of time you want to elapse before the unit turns off. For example, if you set the TIMER OFF for 2 hours, "2.0h" will appear on the screen, and the unit will turn off after 2 hours

2. Press the TIMER OFF button repeatedly to set the time that you want the unit to turn off.



## Timer Functions (cont.)

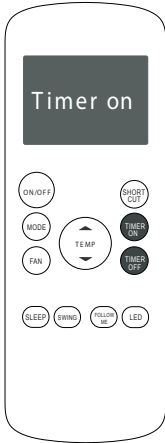

Continue to press **TIMER ON** or **TIMER OFF** until desired time is reached.

- Wait 2 seconds, then the **TIMER OFF** function will be activated. The digital display on your remote control will then return to the temperature display.

### NOTE

When setting the **TIMER ON** or **TIMER OFF** functions, up to 10 hours, the time will increase in 30 minute increments with each press. After 10 hours and up to 24, it will increase in 1 hour increments. The timer will revert to zero after 24 hours.

You can turn off either function by setting the timer to "0.0h".

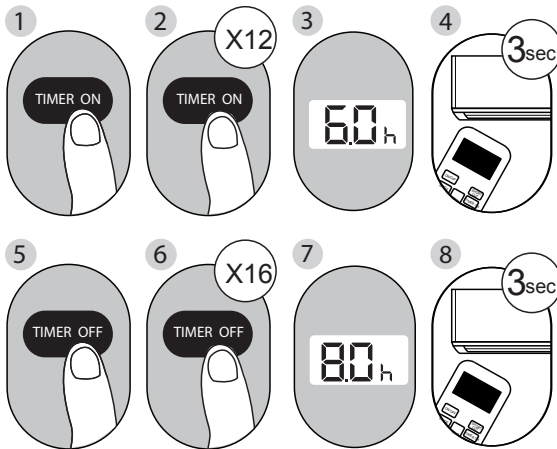

### Setting both **TIMER ON** and **TIMER OFF** at the same time

Keep in mind that the time periods you set for both functions refer to hours after the current time.

For example, say that the current time is 1:00 PM, and you want the unit to turn on automatically at 7:00 PM and want it to operate for 2 hours, then automatically turn off at 9:00 PM.

Do the following (side figure):"  
- change to say "Follow the illustration to the left:

Example: Setting the unit to turn on after 6 hours, operate for 2 hours, then turn off (see the figure below)

Your remote display

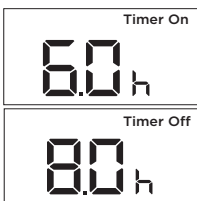

Timer is set To turn ON 6 hours from current time

Timer is set To turn OFF 8 hours from current time

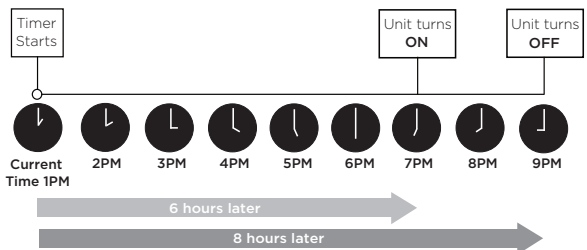

## Advanced Functions

### SLEEP Function

The SLEEP function is used to decrease energy use while you sleep (and don't need the same temperature settings to stay comfortable). This function can only be activated via remote control.

**Note: The SLEEP function is not available in FAN or DRY mode.**

### SWING Function

Used to stop or start louver movement and set the desired up/down air flow direction. The louver angle changes in 6 degree increments). By pressing for more than 2 seconds, the louver auto swing feature is activated.

### FOLLOW ME Function

The FOLLOW ME function enables the remote control to measure the temperature at its current location. When using AUTO, COOL, or HEAT functions, measuring ambient temperature from the remote control (instead of from the indoor unit it self) will enable the air conditioner to optimize the temperature around you and ensure maximum comfort.

1. Press FOLLOW ME button to activate function. The remote control will send temperature signal to the unit every three minutes.
2. Press FOLLOW ME button again to turn off this function.

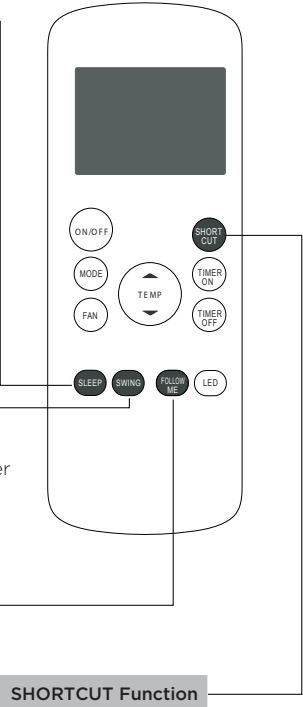

### SHORTCUT Function

- Used to restore the current settings or resume previous settings.
- Push this button when remote control is on, the system will automatically revert back to the previous settings including operating mode, setting temperature, fan speed level and sleep feature (if activated).
- By pressing for more than 2 seconds, the system will automatically restore the current operation settings including operating mode, setting temperature, fan speed level and sleep feature (if activated).

## NOTES

- Button configuration shown in illustrations is based on a typical model and may be slightly different from the actual one you purchased. In this case, please refer to your purchased remote control.
- All the functions described can also be accomplished by using the unit's control panel. If the unit is without this feature, there will be no corresponding operation when pressing the relevant button on the remote control.

## NOTES

- When there are differences between features or operation implied by the remote control illustration and the actual functions described in the USER MANUAL, please refer to the descriptions in the USER MANUAL.
- The device may comply with local national regulations. In Canada, it should comply with CAN ICES-3(B)/NMB-3(B). In USA, this device complies with part 15 of the FCC Rules. Operation is subject to the following two conditions: (1) this device may not cause harmful interference, and (2) this device must accept any interference received, including interference that may cause undesired operation.
- This equipment has been tested and found to comply with the limits for a Class B digital device, pursuant to part 15 of the FCC Rules. These limits are designed to provide reasonable protection against harmful interference in a residential installation. This equipment generates, uses and can radiate radio frequency energy and, if not installed and used in accordance with the instructions, may cause harmful interference to radio communications. However, there is no guarantee that interference will not occur in a particular installation. If this equipment does cause harmful interference to radio or television reception, which can be determined by turning the equipment off and on, the user is encouraged to try to correct the interference by one or more of the following measures:
  - Reorient or relocate the receiving antenna.
  - Increase the separation between the equipment and receiver.
  - Connect the equipment to an outlet on a circuit different from that to which the receiver is connected.
  - Consult the dealer or an experienced radio/TV technician for help. Changes or modifications not approved by the party responsible for compliance could void users authority to operate the equipment.

# Warranty

## Air Conditioner Limited Warranty

Your product is protected by this Limited Warranty:

Warranty service must be obtained from Midea Consumer Services or an authorized Midea servicer.

---

### Warranty

- Two-year limited warranty from original purchase date. Five-year compressor warranty from original purchase date.

### Midea, through its authorized servicers will:

- Pay all costs for repairing or replacing parts of this appliance which prove to be defective in materials or workmanship.

### Consumer will be responsible for:

- Diagnostics, removal, transportation and reinstallation cost required because of service.
- Costs of service calls that are a result of items listed under NORMAL RESPONSIBILITIES OF THE CONSUMER\*\*

Midea replacement parts shall be used and will be warranted only for the original warranty.

---

### NORMAL RESPONSIBILITIES OF THE CONSUMER\*\*

**This warranty applies only to products in ordinary household use, and the consumer is responsible for the items listed below:**

1. Proper use of the appliance in accordance with instructions provided with the product.
2. Routine maintenance and cleaning necessary to keep the good working condition.
3. Proper installation by an authorized service professional in accordance with instructions provided with the appliance and in accordance with all local plumbing, electrical and/or gas codes.
4. Proper connection to a grounded power supply of sufficient voltage, replacement of blown fuses, repair of loose connections or defects in house wiring.
5. Expenses for making the appliance accessible for servicing.
6. Damages to finish after installation.

### EXCLUSIONS

**This warranty does not cover the following:**

- 1) Failure caused by damage to the unit while in your possession (other than damage caused by defect or malfunction), by its improper installation, or by unreasonable use of the unit, including without limitation, failure to provide reasonable and necessary maintenance or to follow the written installation and Operating Instructions.
- 2) Damages caused by services performed by persons other than authorized Midea customer service; or external causes such as abuse, misuse, inadequate power supply or acts of God.
- 3) If the unit is put to commercial, business, rental, or other use or application other than for consumer use, we make no warranties, express or implied, including but not limited to, any implied warranty of merchantability or fitness for use or purpose.
- 4) Products without original serial numbers or products that have serial numbers which have been altered or cannot be readily determined.

**NOTE: Some states do not allow the exclusions or limitation of incidental or consequential damages. So this limitation or exclusion may not apply to you.**

### IF YOU NEED SERVICE

Keep your bill of sale, delivery slip, or some other appropriate payment Record.

The date on the bill establishes the warranty period, should service be required.

If service is performed, it's your best interest to obtain and keep all receipts.

This written warranty gives you specific legal rights. You may also have other rights that vary from state to state.

Service under this warranty must be obtained by following these steps, in order:

- 1) Contact Midea Consumer Services or an authorized Midea services at 1 866 646 4332.
- 2) If there is a question as to where to obtain service, contact our consumer relations Department.

## **How to Stay Cool with a New Portable Air Conditioner**

Because of a new federal test procedure for Portable Air Conditioners, you may notice that the cooling capacity claims on portable air conditioner packaging are significantly lower than that of models produced prior to 2017. This is due to changes in the test procedure, not to the portable air conditioners themselves.

### **What should I look for first when purchasing a portable air conditioner?**

The right air conditioner helps you cool a room efficiently. An undersized unit won't cool adequately while one that's too large will not remove enough humidity, leaving the air feeling damp. To find the proper air conditioner, determine the square footage of the room you want to cool by multiplying the room length by its width. You also need to know the air conditioner's BTU (British Thermal Unit) rating, which indicates the amount of heat it can remove from a room. A higher number means more cooling power for a larger room. (Be sure you are comparing only newer models to each other- older models may appear to have a higher capacity, but are actually the same). Be sure to "size up" if your portable air conditioner will be placed in a very sunny room, in a kitchen, or in a room with high ceilings. After you've found the right cooling capacity for your room, you can look at other features.

### **Why is the cooling capacity lower on newer models than on older units?**

Federal regulations require manufacturers to calculate cooling capacity based on a specific test procedure. Models manufactured before 2017 were tested under a different procedure and cooling capacity is measured differently than in prior years' models. So, while the BTUs may be lower, the actual cooling capacity of the air conditioners has not changed.

### **What is SACC ?**

SACC is the representative value of Seasonally Adjusted Cooling Capacity, in Btu/h, as determined in accordance with the DOE test procedure at title 10 Code of Federal Regulations (CFR) 430, subpart B, appendix CC and applicable sampling plans.







**PELONIS™**