

NOTE: DIMENSIONS IN [] ARE INCH EQUIVALENTS.

REV	DATE	ON COMPOSITE DWGS, SEE PART NO. FOR REVISION LEVEL	BY	DO NOT SCALE, REFERENCE THE MODEL FOR ALL UNSPECIFIED DIMENSIONS								
-	9-23-17	NEW DRAWING [CT179368]	ADP	<small>UNLESS OTHERWISE SPECIFIED: ALL DIMENSIONS IN MILLIMETERS GENERAL TOLERANCES: N/A</small> KOHLER. <small>KOHLER, WISCONSIN 53044</small> THIS DRAWING IN DESIGN AND DETAIL IS KOHLER CO. PROPERTY AND MUST NOT BE USED EXCEPT IN CONNECTION WITH KOHLER CO. WORK. ALL RIGHTS OF DESIGN OR INVENTION ARE RESERVED. TITLE DIMENSION PRINT, 14/20KW RCA SCALE 0.16 CAD NO. SHEET 1 of 5 DWG NO. ADV-8928								
A	12-15-17	SEE SHEET 3 OF 5 [CT182535]	KRM									
B	5-24-18	SEE SHEET 4 & 5 [CT187735]	ADP									
C	19JUN2019	SEE SHEET 4 [PR08238]	AWK									
D	17OCT2019	SEE SHEET 4 [PR08565]	CEK									
<table border="1"> <thead> <tr> <th>APPROVALS</th> <th>DATE</th> </tr> </thead> <tbody> <tr> <td>ADP</td> <td>9-23-17</td> </tr> <tr> <td>VPP</td> <td>9-23-17</td> </tr> <tr> <td>BJF</td> <td>9-23-17</td> </tr> </tbody> </table>				APPROVALS	DATE	ADP	9-23-17	VPP	9-23-17	BJF	9-23-17	
APPROVALS	DATE											
ADP	9-23-17											
VPP	9-23-17											
BJF	9-23-17											

14/20RCA

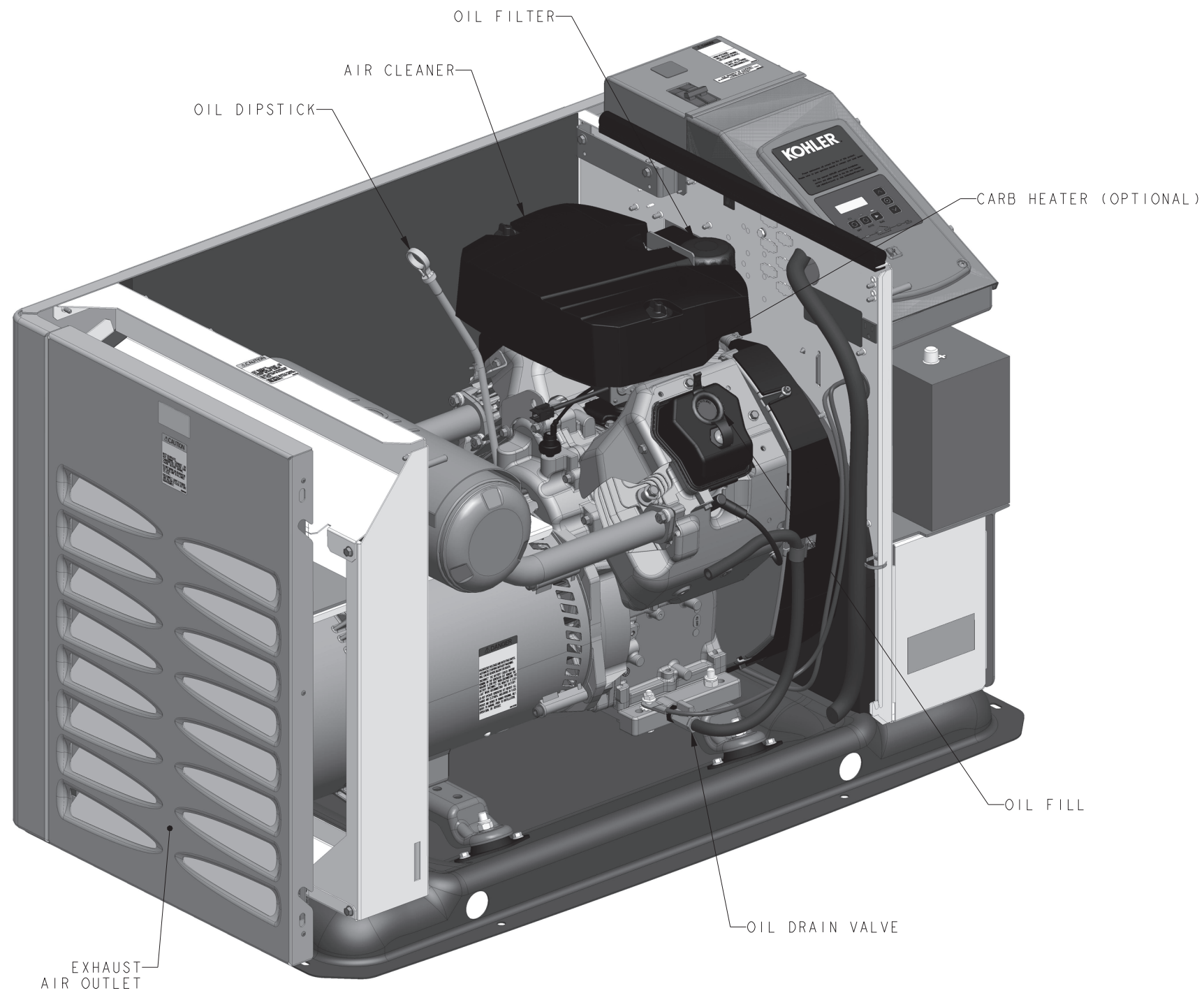

REV	DATE	ON COMPOSITE DWGS. SEE PART NO. FOR REVISION LEVEL	BY	DO NOT SCALE. REFERENCE THE MODEL FOR ALL UNSPECIFIED DIMENSIONS								
-	9-23-17	NEW DRAWING [CT179368]	ADP	<small>UNLESS OTHERWISE SPECIFIED: ALL DIMENSIONS IN MILLIMETERS GENERAL TOLERANCES: N/A</small> KOHLER. <small>KOHLER, WISCONSIN 53044</small> THIS DRAWING IN DESIGN AND DETAIL IS KOHLER CO. PROPERTY AND MUST NOT BE USED EXCEPT IN CONNECTION WITH KOHLER CO. WORK. ALL RIGHTS OF DESIGN OR INVENTION ARE RESERVED.								
A	12-15-17	SEE SHEET 3 OF 5 [CT182535]	KRM									
B	5-24-18	SEE SHEET 4 & 5 [CT187735]	ADP									
C	19JUN2019	SEE SHEET 4 [PR08238]	AWK									
D	17OCT2019	SEE SHEET 4 [PR08565]	CEK									
				<small>THIRD ANGLE PROJECTION</small> 								
			<table border="1"> <thead> <tr> <th>APPROVALS</th> <th>DATE</th> </tr> </thead> <tbody> <tr> <td>DRAWN ADP</td> <td>9-23-17</td> </tr> <tr> <td>CHECKED VPP</td> <td>9-23-17</td> </tr> <tr> <td>APPROVED BJJ</td> <td>9-23-17</td> </tr> </tbody> </table>	APPROVALS	DATE	DRAWN ADP	9-23-17	CHECKED VPP	9-23-17	APPROVED BJJ	9-23-17	TITLE DIMENSION PRINT, 14/20KW RCA SCALE 0.16 CAD NO. SHEET 2 of 5 DWG NO. ADV-8928
APPROVALS	DATE											
DRAWN ADP	9-23-17											
CHECKED VPP	9-23-17											
APPROVED BJJ	9-23-17											

14/20RCA

D



AIR INLET

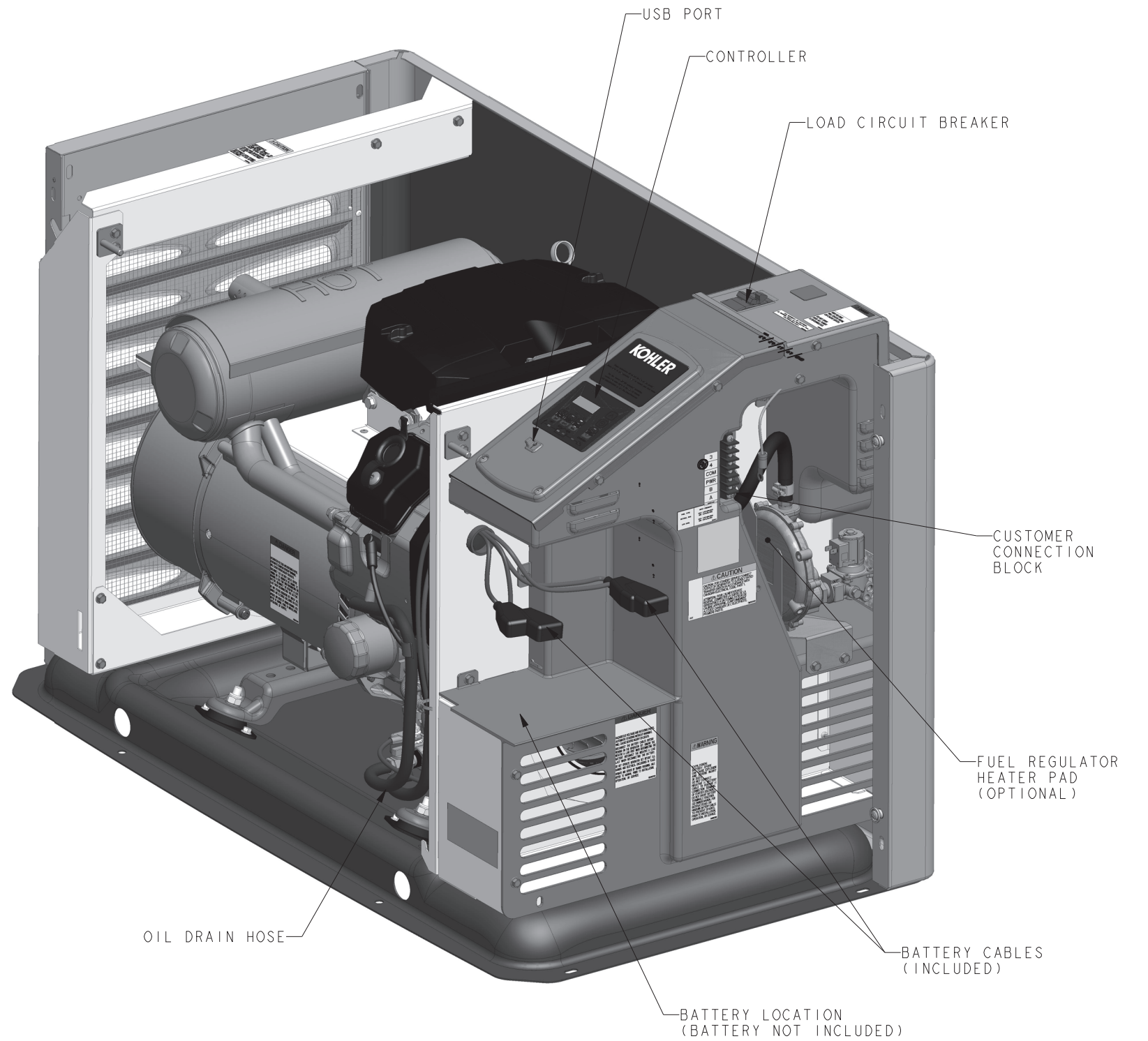

USB PORT

CONTROLLER

LOAD CIRCUIT BREAKER

CUSTOMER CONNECTION BLOCK

FUEL REGULATOR HEATER PAD (OPTIONAL)

BATTERY CABLES (INCLUDED)

BATTERY LOCATION (BATTERY NOT INCLUDED)

OIL DRAIN HOSE

REV	DATE	ON COMPOSITE DWGS. SEE PART NO. FOR REVISION LEVEL	BY	DO NOT SCALE. REFERENCE THE MODEL FOR ALL UNSPECIFIED DIMENSIONS										
-	9-23-17	NEW DRAWING [CT179368]	ADP	UNLESS OTHERWISE SPECIFIED: ALL DIMENSIONS IN MILLIMETERS GENERAL TOLERANCES: N/A KOHLER KOHLER, WISCONSIN 53044 THIS DRAWING IN DESIGN AND DETAIL IS KOHLER CO. PROPERTY AND MUST NOT BE USED EXCEPT IN CONNECTION WITH KOHLER CO. WORK. ALL RIGHTS OF DESIGN OR INVENTION ARE RESERVED. TITLE DIMENSION PRINT, 14/20KW RCA SCALE 0.30 CAD NO. SHEET 3 of 5 DWG NO. ADV-8928										
A	12-15-17	UPDATED FUEL REGULATOR GEOMETRY [CT182353]	KRM											
B	5-24-18	SEE SHEET 4 & 5 [CT187735]	ADP											
C	19JUN2019	SEE SHEET 4 [PR08238]	AWK											
D	17OCT2019	SEE SHEET 4 [PR08565]	CEK											
<table border="1"> <thead> <tr> <th colspan="2">THIRD ANGLE PROJECTION</th> </tr> <tr> <th>APPROVALS</th> <th>DATE</th> </tr> </thead> <tbody> <tr> <td>DRAWN ADP</td> <td>9-23-17</td> </tr> <tr> <td>CHECKED VPP</td> <td>9-23-17</td> </tr> <tr> <td>APPROVED BJF</td> <td>9-23-17</td> </tr> </tbody> </table>				THIRD ANGLE PROJECTION		APPROVALS	DATE	DRAWN ADP	9-23-17	CHECKED VPP	9-23-17	APPROVED BJF	9-23-17	
THIRD ANGLE PROJECTION														
APPROVALS	DATE													
DRAWN ADP	9-23-17													
CHECKED VPP	9-23-17													
APPROVED BJF	9-23-17													

14/20RCA

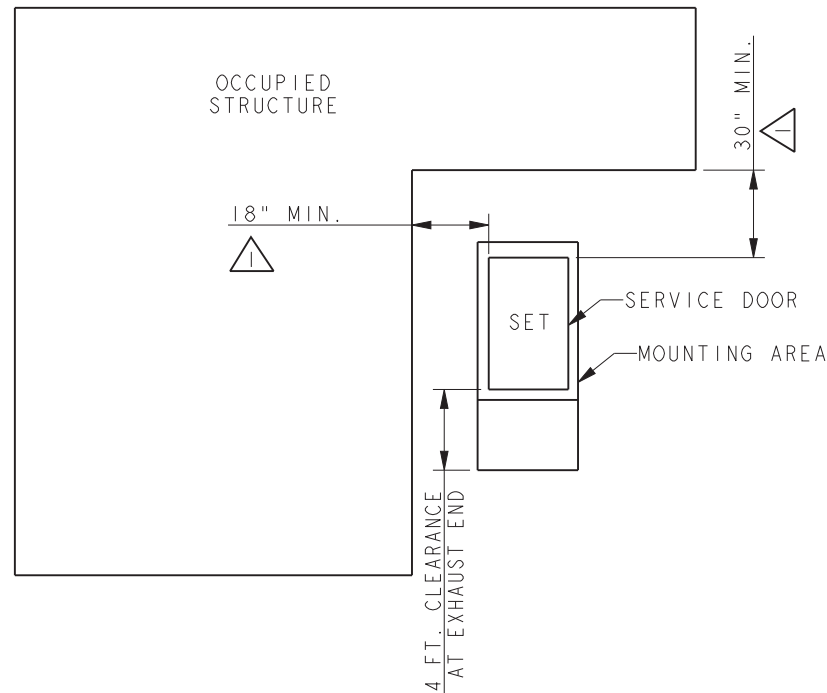
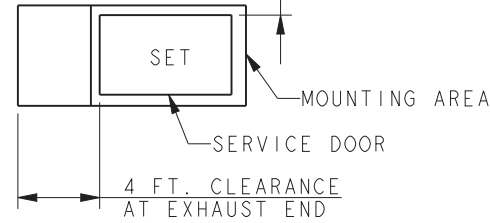
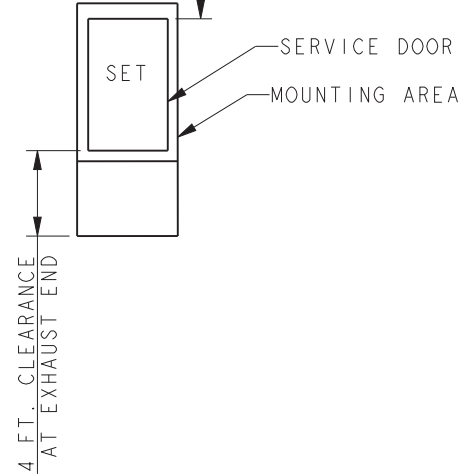
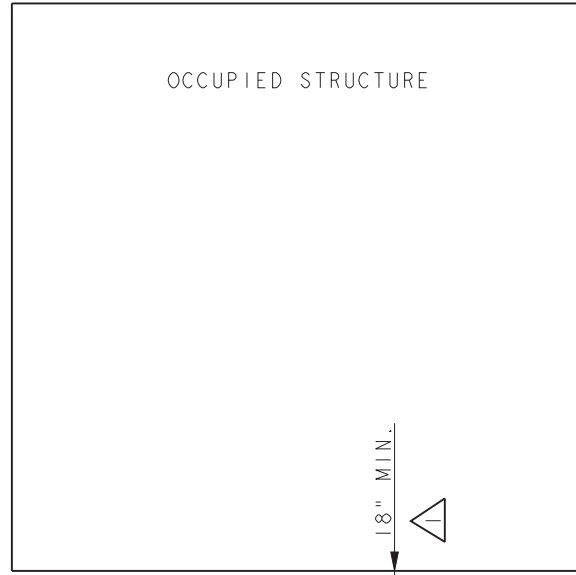
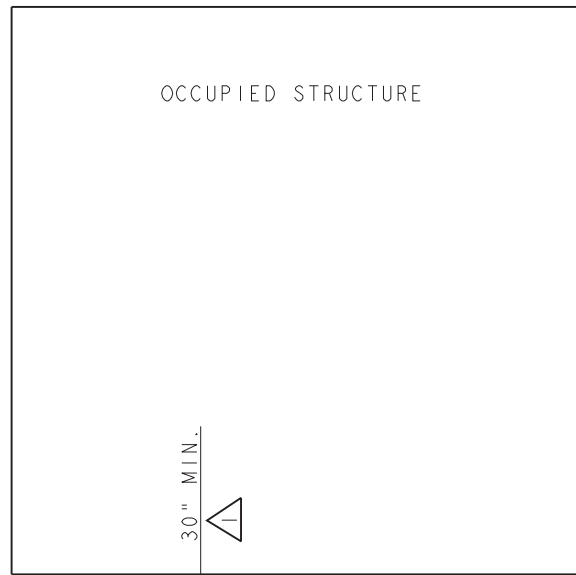



NOTE:
 THE RECOMMENDED DISTANCE FROM A STRUCTURE IS DEPENDENT ON STATE AND LOCAL CODES. PRODUCT HAS BEEN DEMONSTRATED IN ACCORDANCE WITH NFPA 37 SECTION 4.1.4 BY A THIRD PARTY TEST FACILITY TO THE DIMENSIONS SHOWN.

ACCEPTABLE

- 1) EXHAUST IS AIMED AWAY OR PARALLEL TO STRUCTURE.
- 2) EXHAUST IS NOT DIRECTED AT PLAY AREAS, PATIOS OR OTHER AREAS WHERE PEOPLE CONGREGATE.
- 3) THE NEAREST WINDOW, VENT, DOOR OR SIMILAR STRUCTURE OPENING IS AT LEAST 5 FEET FROM THE EXHAUST END OF THE SET.
- 4) SET HAS PROPER OFFSET FROM STRUCTURE.
- 5) WINDOWS & DOORS ON ADJACENT WALLS ARE CLOSED.
- 6) FURNACE AND OTHER SIMILAR INTAKES ARE AT LEAST 10 FEET FROM EXHAUST END OF SET.
- 7) WEED BARRIER AND 3 INCH THICK GRAVEL BASE OR CONCRETE PAD LOCATED TO PREVENT GRASS & WEEDS FROM GROWING TOO CLOSE TO THE SET.
- 8) NO PLANTS, SHRUBS OR OTHER COMBUSTIBLES ALLOWED IN CLEARANCE AREA. (MINIMUM 4 FT. FROM EXHAUST END).
- 9) REFER TO OWNERS MANUAL FOR OTHER INSTALLATION CONSTRAINTS.
- 10) NO PLANTS, SHRUBS, OR OTHER COMBUSTIBLES ALLOWED WITHIN 30" OF AIR INTAKE.

**14/20RCA
 SINGLE UNIT
 CONFIGURATION**

REV	DATE	ON COMPOSITE DWGS. SEE PART NO. FOR REVISION LEVEL	BY	DO NOT SCALE. REFERENCE THE MODEL FOR ALL UNSPECIFIED DIMENSIONS
-	9-23-17	NEW DRAWING [CTI79368]	ADP	UNLESS OTHERWISE SPECIFIED: ALL DIMENSIONS IN MILLIMETERS GENERAL TOLERANCES: N/A
A	12-15-17	SEE SHEET 3 OF 5 [CTI82535]	KRM	
B	5-24-18	(A-5,C-7) 30" MIN WAS 18" MIN; (C-3) NOTE UPDATED [CTI87735]	ADP	 TITLE DIMENSION PRINT, 14/20KW RCA SCALE 0.16 CAD NO. SHEET 4 of 5 DWG NO. ADV-8928 D
C	19JUN2019	(B-3) 30" WAS 18"; (C-7 & B-5)  REMOVED FROM 30" MIN. DIMENSIONS [PR08238]	AWK	
D	17OCT2019	(C-3) NOTE  REMOVED, VIEWS UPDATED [PR08565]	CEK	

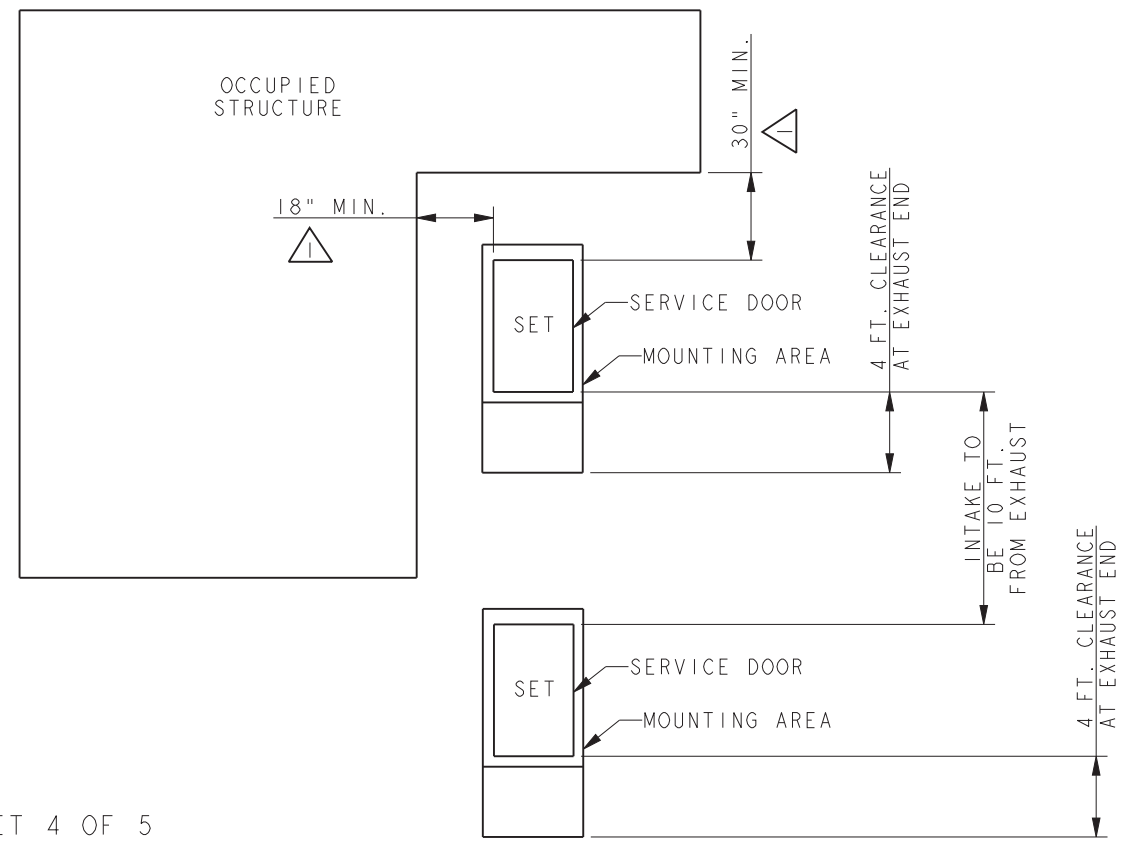
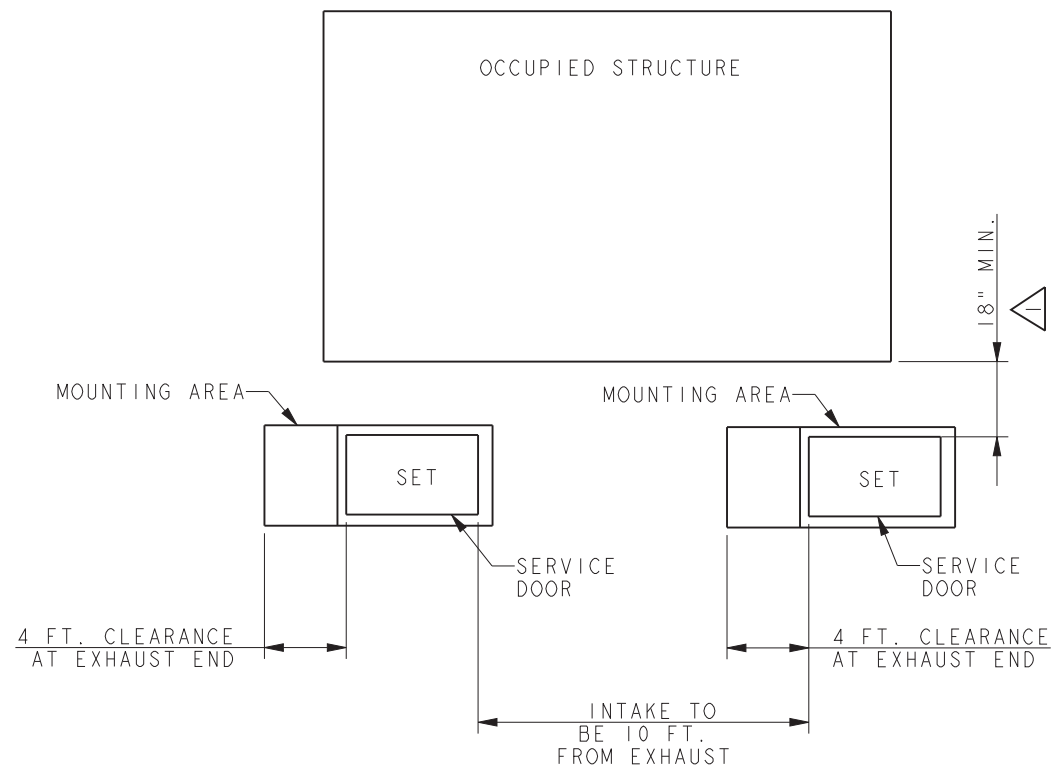
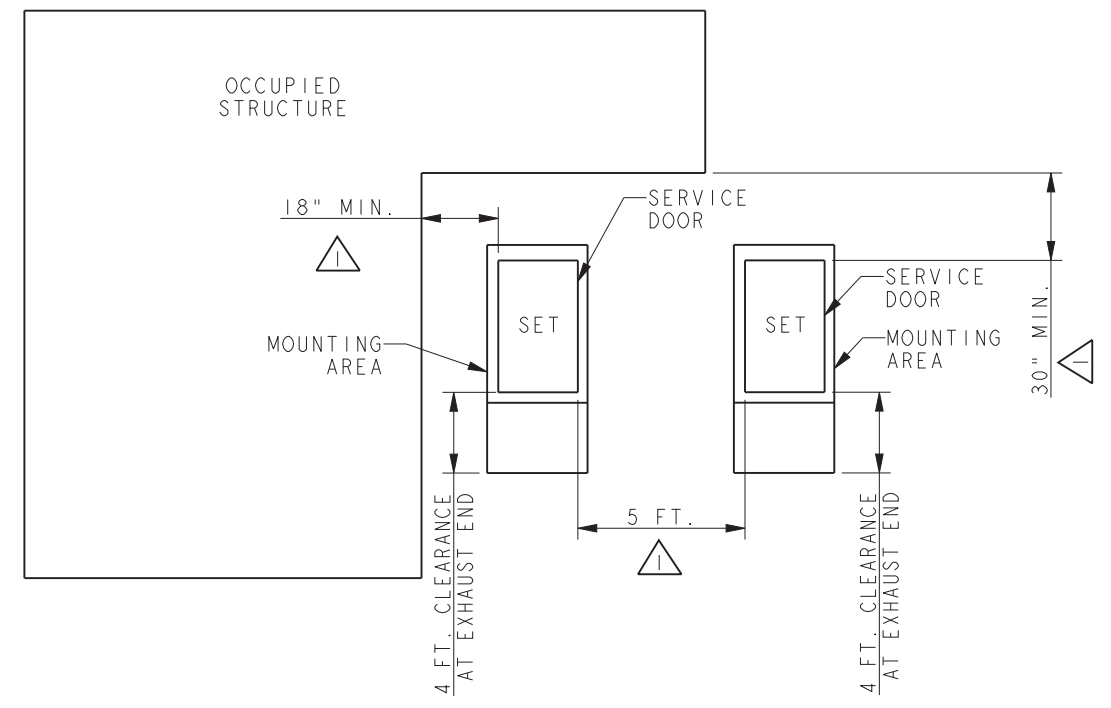
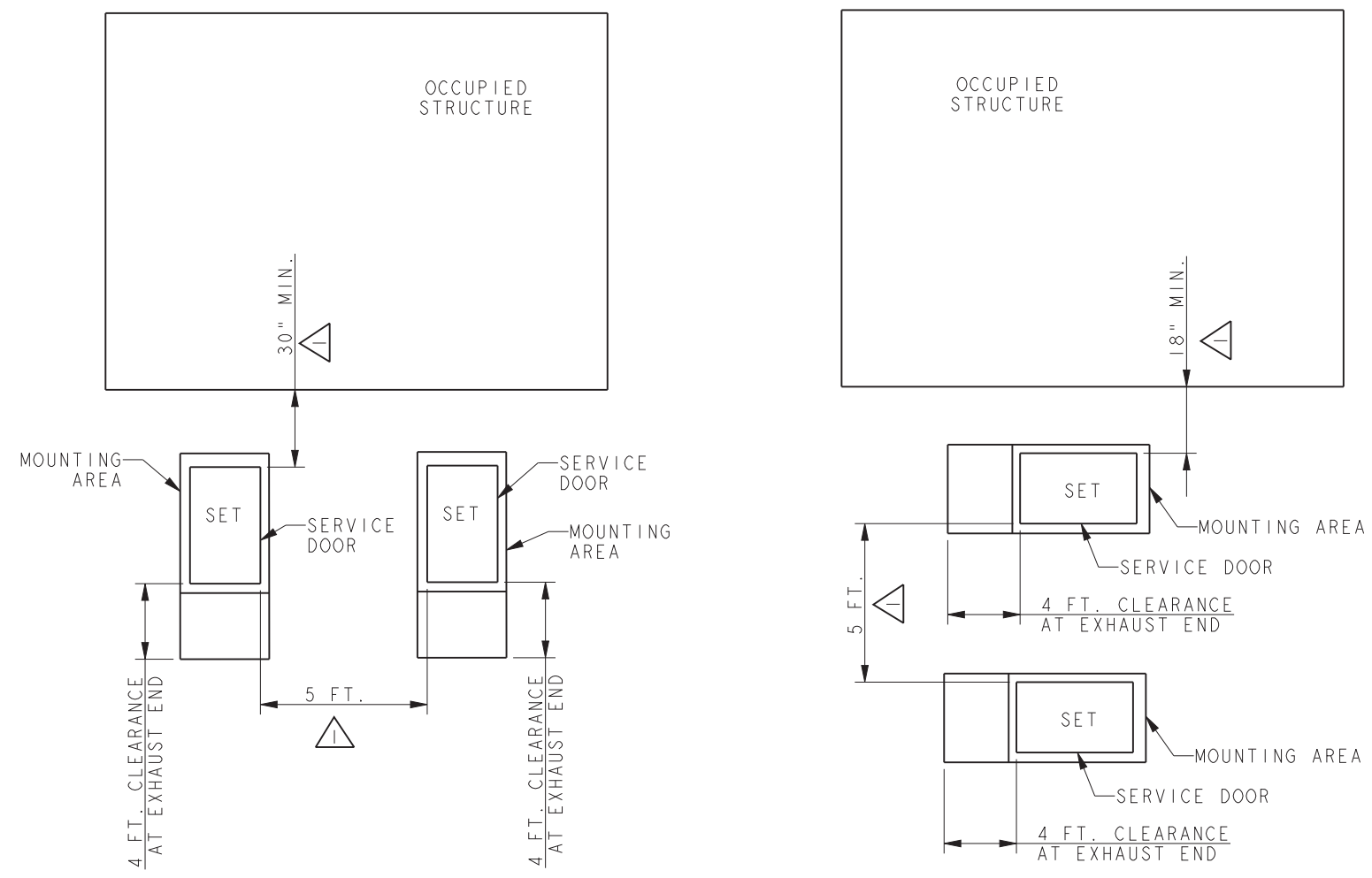

NOTE:
APPLY NOTES ON SHEET 4 OF 5
TO SHEET 5 OF 5.

14/20RCA
PARALLEL UNIT
CONFIGURATION

REV	DATE	ON COMPOSITE DWGS. SEE PART NO. FOR REVISION LEVEL	BY	DO NOT SCALE. REFERENCE THE MODEL FOR ALL UNSPECIFIED DIMENSIONS
-	9-23-17	NEW DRAWING [CT179368]	ADP	UNLESS OTHERWISE SPECIFIED: ALL DIMENSIONS IN MILLIMETERS GENERAL TOLERANCES: N/A
A	12-15-17	SEE SHEET 3 OF 5 [CT182535]	KRM	KOHLER. KOHLER, WISCONSIN 53044 THIS DRAWING IN DESIGN AND DETAIL IS KOHLER CO. PROPERTY AND MUST NOT BE USED EXCEPT IN CONNECTION WITH KOHLER CO. WORK. ALL RIGHTS OF DESIGN OR INVENTION ARE RESERVED.
B	5-24-18	(D-7,D-1,B-2) 30" MIN WAS 18" MIN [CT187735]	ADP	
C	19JUN2019	SEE SHEET 4 [PR08238]	AWK	
D	17OCT2019	SEE SHEET 4 [PR08565]	CEK	
				THIRD ANGLE PROJECTION
		APPROVALS	DATE	TITLE
		DRAWN	ADP 9-23-17	DIMENSION PRINT, 14/20KW RCA
		CHECKED	VPP 9-23-17	SCALE 0.16 CAD NO. SHEET 5 of 5
		APPROVED	BJF 9-23-17	DWG NO. ADV-8928 D