

**INSIGNIA™**

# Portable Air Conditioner

NS-AC06PWH1/NS-AC07PWH1/NS-AC08PWH1



Before using your new product, please read these instructions to prevent any damage.

## Contents

Introduction .....	3
Features .....	9
Package contents .....	9
Front .....	9
Back .....	10
Control panel .....	11
Ambient temperature range .....	11
Remote control .....	12
Remote control display .....	14
Before installing your air conditioner .....	15
Finding a suitable location .....	15
Providing the correct power source .....	16
Installing your air conditioner .....	16
Tools you need (not included) .....	16
Window installation kit .....	17
STEP 1: Connect the exhaust hose to your air conditioner .....	17
STEP 2: Assembling the adjustable window slides .....	19
STEP 3: Preparing the window frame and sash .....	20
STEP 4: Connecting the assembled exhaust hose to the window .....	22
Using your air conditioner .....	22
Turning your air conditioner on or off .....	22
Selecting the operating mode .....	22
Setting the operating temperature .....	23
Setting the temperature format .....	23
Adjusting the fan speed .....	23
Controlling the vent .....	23
Setting the timers .....	23
Using the Sleep feature .....	24
Setting the shortcut .....	24
Turning the control panel display on or off .....	24
Using the Follow Me feature .....	24
Using the dehumidifier feature .....	25
Maintaining your air conditioner .....	25
Safety guidelines .....	25
Cleaning the exterior .....	25
Cleaning the air filter .....	26
Emptying the drain tray .....	26
Storing your air conditioner .....	27
Troubleshooting .....	27
Error codes .....	28
Specifications .....	28
Legal notices .....	28
ONE-YEAR LIMITED WARRANTY .....	29

## Introduction

Congratulations on your purchase of this Insignia product. Your NS-AC06PWH1, NS-AC07PWH1, or NS-AC08PWH1 is a state of the art portable air conditioner and is designed for reliable and trouble-free performance.

## IMPORTANT SAFEGUARDS

Read these safety precautions before operation and installation to prevent death or injury to the user or other people and property damage. The following instructions must be followed. Incorrect operation due to ignoring of instructions may cause death, harm, or damage.

	<b>WARNING</b>	This symbol indicates the possibility of personal injury or loss of life.
---	----------------	---

	<b>CAUTION</b>	This symbol indicates the possibility of property damage or serious consequences.
---	----------------	---

### **WARNING**

- Installation must be performed according to the installation instructions. Improper installation can cause water leakage, electrical shock, or fire.
- Use only the included accessories and parts, and specified tools for the installation. Using nonstandard parts can cause water leakage, electrical shock, fire, and injury or property damage.
- Make sure that the outlet you are using is grounded and has the appropriate voltage. The power cord is equipped with a three-prong grounding plug to protect against shock. Voltage information can be found on the nameplate of the unit.
- Your unit must be used in a properly grounded wall receptacle. If the wall receptacle you intend to use is not adequately grounded or protected by a time delay fuse or circuit breaker (the fuse or circuit breaker needed is determined by the maximum current of the unit. The maximum current is indicated on the nameplate located on unit), have a qualified electrician install the proper receptacle.
- Install the unit on a flat, sturdy surface. Failure to do so could result in damage or excessive noise and vibration.
- The unit must be kept free from obstruction to ensure proper function and to mitigate safety hazards.
- Do not modify the length of the power cord or use an extension cord to power the unit.
- Do not share a single outlet with other electrical appliances. Improper power supply can cause fire or electrical shock.
- Do not install your air conditioner in a wet room such as a bathroom or laundry room. Too much exposure to water can cause electrical components to short circuit.
- Do not install the unit in a location that may be exposed to combustible gas, as this could cause fire.
- The unit has wheels to facilitate moving. Make sure not to use the wheels on thick carpet or to roll over objects, as these could cause tipping.
- Do not operate a unit that it has been dropped or damaged.
- Do not touch the unit with wet or damp hands or when barefoot.
- If the air conditioner is knocked over during use, turn off the unit and unplug it from the main power supply immediately. Visually inspect the unit to ensure there is no damage. If you suspect the unit has been damaged, contact a technician or customer service for assistance.
- In a thunderstorm, the power must be cut off to avoid damage to the machine due to lightning.
- Your air conditioner should be used in such a way that it is protected from moisture, e.g. condensation, splashed water, etc. Do not place or store your air conditioner where it can fall or be pulled into water or any other liquid. Unplug immediately if it occurs.
- All wiring must be performed strictly in accordance with the wiring diagram located inside of the unit.
- The unit's circuit board (PCB) is designed with a fuse to provide overcurrent protection. The specifications of the fuse are printed on the circuit board, such as: T 3.15A/250V, etc.
- When the water drainage function is not in use, keep the upper and the lower drain plug firmly to the unit to get rid of choking. When the drain plug is not in use, keep it away from children to avoid possible choking.

### **CAUTION**

- If the supply cord is damaged, it must be replaced by the manufacturer, its service agent, or similarly qualified persons in order to avoid a hazard.
- Prior to cleaning or other maintenance, the appliance must be disconnected from the supply outlet.
- Do not remove any fixed covers. Never use this appliance if it is not working properly, or if it has been dropped or damaged.
- Do not run the cord under carpeting. Do not cover the cord with throw rugs, runners, or similar coverings. Do not route the cord under furniture or appliances. Arrange the cord away from traffic area and where it will not be tripped over.

- Do not operate the unit with a damaged cord, plug, power fuse, or circuit breaker. Discard the unit or return to an authorized service facility for examination and/or repair.
- To reduce the risk of fire or electric shock, do not use this air conditioner with any solid-state speed control device.
- The appliance shall be installed in accordance with national wiring regulations.
- Contact the authorized service technician for repair or maintenance of this unit.
- Contact an authorized installer for installation of this unit.
- Do not cover or obstruct the inlet or outlet grilles.
- Do not use this product for functions other than those described in this instruction manual.
- Before cleaning, turn off the power and unplug the unit.
- Disconnect the power if strange sounds, smell, or smoke comes from it.
- Do not press the buttons on the control panel with anything other than your fingers.
- Do not remove any fixed covers. Never use this appliance if it is not working properly, or if it has been dropped or damaged.
- Do not operate or stop the unit by inserting or pulling out the power cord plug.
- Do not use hazardous chemicals to clean or come into contact with the unit. Do not use the unit in the presence of inflammable substances or vapor such as alcohol, insecticides, gasoline, etc.
- Always transport your air conditioner in a vertical position and stand on a stable, level surface during use.
- Always contact a qualified person to carry out repairs. If the damaged power supply cord must be replaced with a new power supply cord, obtain one from the product manufacturer. Do not try to repair the cord.
- Hold the plug by the head of the power plug when taking it out.
- Turn off the product when not in use.

## Note about fluorinated gases

- 1 Fluorinated greenhouse gases are contained in hermetically sealed equipment. For specific information on the type, the amount, and the CO<sub>2</sub> equivalent in metric tons of the fluorinated greenhouse gas (on some models), please refer to the relevant label on the unit itself.
- 2 Installation, service, maintenance, and repair of this unit must be performed by a certified technician.
- 3 Product uninstallation and recycling must be performed by a certified technician.

## End of life directives



When using this dehumidifier in the European countries, the following information must be followed:

**DISPOSAL:** Do not dispose this product as unsorted municipal waste. Collection of such waste separately for special treatment is necessary. It is prohibited to dispose of this appliance in domestic household waste. For disposal, there are several possibilities:

- The municipality has established collection systems, where electronic waste can be disposed of at least free of charge to the user.
- When buying a new product, the retailer will take back the old product at least free of charge.
- The manufacture will take back the old appliance for disposal at least free of charge to the user.
- As old products contain valuable resources, they can be sold to scrap metal dealers. Wild disposal of waste in forests and landscapes endangers your health when hazardous substances leak into the ground-water and find their way into the food chain.



## **WARNING: Using R32/R290 refrigerant**

- Do not use any means to accelerate the defrosting process or to clean, other than those recommended by the manufacturer.
- The appliance shall be stored in a room without continuously operating ignition sources (for example: open flames, an operating gas appliance or an operating electric heater).
- Do not pierce or burn.
- Be aware that the refrigerants may not contain an odor.

- Appliance should be installed, operated, and stored in a room with a floor area according to the amount of refrigerant to be charged. For specific information on the type of gas and the amount, please refer to the relevant label on the unit itself. When there are differences between the label and the manual on the Min. room area description, the description on the label shall prevail.





FOR R290			
AMOUNT OF REFRIGERANT (KG)	MIN. ROOM AREA (M <sup>2</sup> )	AMOUNT OF REFRIGERANT (KG)	MIN. ROOM AREA (M <sup>2</sup> )
> 0.0836 and ≥ 0.1045	4	> 0.2090 and ≥ 0.2299	11
> 0.1045 and ≥ 0.1254	4	> 0.2299 and ≥ 0.2508	12
> 0.1254 and ≥ 0.1520	4	> 0.2508 and ≥ 0.2717	13
> 0.1520 and ≥ 0.1672	8	> 0.2717 and ≥ 0.2926	14
> 0.1672 and ≥ 0.1881	9	> 0.2926 and ≥ 0.3040	15
> 0.1881 and ≥ 0.2090	10		

- Compliance with national gas regulations shall be observed.
- Keep ventilation openings clear of obstruction.
- The appliance shall be stored so as to prevent mechanical damage from occurring.
- A warning that the appliance shall be stored in a well-ventilated area where the room size corresponds to the room area as specified for operation.
- Any person who is involved with working on or breaking into a refrigerant circuit should hold a current valid certificate from an industry-accredited assessment authority, which authorizes their competence to handle refrigerants safely in accordance with an industry recognized assessment specification.
- Servicing shall only be performed as recommended by the equipment manufacturer. Maintenance and repair requiring the assistance of other skilled personnel shall be carried out under the supervision of the person competent in the use of flammable refrigerants.
- Please follow the instruction carefully to handle, install, clear, and service the air conditioner to avoid any damage or hazard. Flammable Refrigerant R32 is used within this air conditioner. When maintaining or disposing the air conditioner, the refrigerant (R32 or R290) shall be recovered properly. It shall not be discharge to the air directly.
- No open fire or device like switch which may generate spark/arcing shall be around air conditioner to avoid causing ignition of the flammable refrigerant used. Please follow the instruction carefully to store or maintain the air conditioner to prevent mechanical damage from occurring.
- Flammable refrigerant R32 is used in air conditioner. Please follow the instruction carefully to avoid any hazard. For specific information on the type of gas and the amount, please refer to the relevant label on the unit itself.



Caution: Risk of fire/  
flammable materials  
(Required for R32/R290 units only)

Explanation of symbols displayed on the unit (When the unit uses R32/R290 Refrigerant only):

 <b>WARNING</b>	This symbol shows that this appliance used a flammable refrigerant. If the refrigerant is leaked and exposed to an external ignition source, there is a risk of fire.
 <b>CAUTION</b>	This symbol shows that the operation manual should be read carefully.
 <b>CAUTION</b>	This symbol shows that a service personnel should be handling this equipment with reference to the installation manual.
 <b>CAUTION</b>	This symbol shows that information is available such as the operating manual or installation manual.

- Transport of equipment containing flammable refrigerants  
See transport regulations
- Marking of equipment using signs  
See local regulations

**3 Disposal of equipment using flammable refrigerants**

See national regulations.

**4 Storage of equipment/appliances**

The storage of equipment should be in accordance with the manufacturer's instructions.

**5 Storage of packed (unsold) equipment**

Storage package protection should be constructed such that mechanical damage to the equipment inside the package will not cause a leak of the refrigerant charge. The maximum number of pieces of equipment permitted to be stored together will be determined by local regulations.

**6 Information on servicing****• Checks to the area**

Prior to beginning work on systems containing flammable refrigerants, safety checks are necessary to ensure that the risk of ignition is minimized. For repair to the refrigerating system, the following precautions shall be complied with prior to conducting work on the system.

**• Work procedure**

Work shall be undertaken under a controlled procedure so as to minimize the risk of a flammable gas or vapor being present while the work is being performed.

**• General work area**

All maintenance staff and others working in the local area shall be instructed on the nature of work being carried out. Work in confined spaces shall be avoided. The area around the workspace shall be sectioned off. Ensure that the conditions within the area have been made safe by control of flammable material.

**• Checking for presence of refrigerant**

The area shall be checked with an appropriate refrigerant detector prior to and during work, to ensure the technician is aware of potentially flammable atmospheres. Ensure that the leak detection equipment being used is suitable for use with flammable refrigerants, i.e. non-sparking, adequately sealed, or intrinsically safe.

**• Presence of fire extinguisher**

If any hot work is to be conducted on the refrigeration equipment or any associated parts, appropriate fire extinguishing equipment shall be available to hand. Have a dry powder or CO2 fire extinguisher adjacent to the charging area.

**• No ignition sources**

No person carrying out work in relation to a refrigeration system which involves exposing any pipe work that contains or has contained flammable refrigerant shall use any sources of ignition in such a manner that it may lead to the risk of fire or explosion. All possible ignition sources, including cigarette smoking, should be kept sufficiently far away from the site of installation, repairing, removing and disposal, during which flammable refrigerant can possibly be released to the surrounding space. Prior to work taking place, the area around the equipment is to be surveyed to make sure that there are no flammable hazards or ignition risks. No Smoking signs shall be displayed.

**• Ventilated area**

Ensure that the area is in the open or that it is adequately ventilated before breaking into the system or conducting any hot work. A degree of ventilation shall continue during the period that the work is carried out. The ventilation should safely disperse any released refrigerant and preferably expel it externally into the atmosphere.

**• Checks to the refrigeration equipment**

Where electrical components are being changed, they shall be fit for the purpose and to the correct specification. At all times the manufacturer's maintenance and service guidelines shall be followed. If in doubt consult the manufacturer's technical department for assistance. The following checks shall be applied to installations using flammable refrigerants:

The charge size is in accordance with the room size within which the refrigerant containing parts are installed;

The ventilation machinery and outlets are operating adequately and are not obstructed;

If an indirect refrigerating circuit is being used, the secondary circuit shall be checked for the presence of refrigerant; Marking to the equipment continues to be visible and legible. Markings and signs that are illegible shall be corrected;

Refrigeration pipe or components are installed in a position where they are unlikely to be exposed to any substance which may corrode refrigerant containing components, unless the components are constructed of materials which are inherently resistant to being corroded or are suitably protected against being so corroded.

### • Checks to electrical devices

Repair and maintenance to electrical components shall include initial safety checks and component inspection procedures. If a fault exists that could compromise safety, then no electrical supply shall be connected to the circuit until it is satisfactorily dealt with. If the fault cannot be corrected immediately but it is necessary to continue operation, an adequate temporary solution shall be used. This shall be reported to the owner of the equipment so all parties are advised.

Initial safety checks shall include:

That capacitors are discharged: this shall be done in a safe manner to avoid possibility of sparking;

That there are no live electrical components or wiring exposed while charging, recovering, or purging the system;

That there is continuity in the grounding.

### 7 Repairs to sealed components

- During repairs to sealed components, all electrical supplies shall be disconnected from the equipment being worked upon prior to any removal of sealed covers, etc. If it is absolutely necessary to have an electrical supply to equipment during servicing, then a permanently operating form of leak detection shall be located at the most critical point to warn of a potentially hazardous situation.
- Particular attention shall be paid to the following to ensure that by working on electrical components, the casing is not altered in such a way that the level of protection is affected. This shall include damage to cables, excessive number of connections, terminals not made to original specification, damage to seals, incorrect fitting of glands, etc. Ensure that apparatus is mounted securely. Ensure that seals or sealing materials have not degraded such that they no longer serve the purpose of preventing the ingress of flammable atmospheres. Replacement parts shall be in accordance with the manufacturer's specifications.

**Note:** The use of silicon sealant may inhibit the effectiveness of some types of leak detection equipment. Intrinsically safe components do not have to be isolated prior to working on them.

### 8 Repair to intrinsically safe components

Do not apply any permanent inductive or capacitance loads to the circuit without ensuring that this will not exceed the permissible voltage and current permitted for the equipment in use. Intrinsically safe components are the only types that can be worked on while live in the presence of a flammable atmosphere. The test apparatus shall be at the correct rating. Replace components only with parts specified by the manufacturer. Other parts may result in the ignition of refrigerant in the atmosphere from a leak.

### 9 Cabling

Check that cabling will not be subject to wear, corrosion, excessive pressure, vibration, sharp edges or any other adverse environmental effects. The check shall also take into account the effects of aging or continual vibration from sources such as compressors or fans.

### 10 Detection of flammable refrigerants

Under no circumstances shall potential sources of ignition be used in the searching for or detection of refrigerant leaks. A halide torch (or any other detector using a naked flame) shall not be used.

### 11 Leak detection methods

The following leak detection methods are deemed acceptable for systems containing flammable refrigerants. Electronic leak detectors shall be used to detect flammable refrigerants, but the sensitivity may not be adequate, or may need re-calibration. (Detection equipment shall be calibrated in a refrigerant-free area.) Ensure that the detector is not a potential source of ignition and is suitable for the refrigerant used. Leak detection equipment shall be set at a percentage of the LFL of the refrigerant and shall be calibrated to the refrigerant employed and the appropriate percentage of gas (25% maximum) is confirmed. Leak detection fluids are suitable for use with most refrigerants but the use of detergents containing chlorine shall be avoided as the chlorine may react with the refrigerant and corrode the copper pipe-work. If a leak is suspected, all naked flames shall be removed/ extinguished.

If a leakage of refrigerant is found which requires brazing, all of the refrigerant shall be recovered from the system, or isolated (by means of shut off valves) in a part of the system remote from the leak.

Oxygen free nitrogen (OFN) shall then be purged through the system both before and during the brazing process.

### 12 Removal and evacuation

When breaking into the refrigerant circuit to make repairs or for any other purpose conventional procedures shall be used. However, it is important that best practice is followed since flammability is a consideration. The following procedure shall be adhered to:

Remove refrigerant; Purge the circuit with inert gas; Evacuate; Purge again with inert gas; Open the circuit by cutting or brazing.

The refrigerant charge shall be recovered into the correct recovery cylinders. The system shall be flushed with OFN to render the unit safe. This process may need to be repeated several times. Compressed air or oxygen shall not be used for this task. Flushing shall be achieved by breaking the vacuum in the system with OFN and continuing to fill until the working pressure is achieved, then venting to atmosphere, and finally pulling down to a vacuum. This process shall be repeated until no refrigerant is within the system. When the final OFN charge is used, the system shall be vented down to atmospheric pressure to enable work to take place. This operation is absolutely vital if brazing operations on the pipe-work are to take place. Ensure that the outlet for the vacuum pump is not close to any ignition sources and there is ventilation available.



### 13 Charging procedures

In addition to conventional charging procedures, the following requirements shall be followed. Ensure that contamination of different refrigerants does not occur when using charging equipment. Hoses or lines shall be as short as possible to minimize the amount of refrigerant contained in them.

Cylinders shall be kept upright.

Ensure that the refrigeration system is grounded prior to charging the system with refrigerant.

Label the system when charging is complete (if not already).

Extreme care shall be taken not to overfill the refrigeration system. Prior to recharging the system it shall be pressure tested with OFN. The system shall be leak tested on completion of charging but prior to commissioning. A follow up leak test shall be carried out prior to leaving the site.

### 14 Decommissioning

Before carrying out this procedure, it is essential that the technician is completely familiar with the equipment and all its detail. It is recommended good practice that all refrigerants are recovered safely.

Prior to the task being carried out, an oil and refrigerant sample shall be taken in case analysis is required prior to re-use of reclaimed refrigerant. It is essential that electrical power is available before the task is commenced.

a) Become familiar with the equipment and its operation. b) Isolate system electrically. c) Before attempting the procedure ensure that: Mechanical handling equipment is available, if required, for handling refrigerant cylinders; All personal protective equipment is available and being used correctly; The recovery process is supervised at all times by a competent person; Recovery equipment and cylinders conform to the appropriate standards. d) Pump down refrigerant system, if possible. e) If a vacuum is not possible, make a manifold so that refrigerant can be removed from various parts of the system. f) Make sure that the cylinder is situated on the scales before recovery takes place. g) Start the recovery machine and operate in accordance with the manufacturer's instructions. h) Do not overfill cylinders. (No more than 80% volume liquid charge). i) Do not exceed the maximum working pressure of the cylinder, even temporarily. j) When the cylinders have been filled correctly and the process completed, make sure that the cylinders and the equipment are removed from site promptly and all isolation valves on the equipment are closed off. k) Recovered refrigerant shall not be charged into another refrigeration system unless it has been cleaned and checked.

### 15 Labeling

Equipment shall be labeled stating that it has been decommissioned and emptied of refrigerant. The label shall be dated and signed. Ensure that there are labels on the equipment stating the equipment contains flammable refrigerant.

### 16 Recovery

When removing refrigerant from a system, either for servicing or decommissioning, it is recommended good practice that all refrigerants are removed safely. When transferring refrigerant into cylinders, ensure that only appropriate refrigerant recovery cylinders are employed. Ensure that the correct number of cylinders for holding the total system charge is available. All cylinders to be used are designated for the recovered refrigerant and labeled for that refrigerant (i.e. special cylinders for the recovery of refrigerant). Cylinders shall be complete with pressure relief valve and associated shut-off valves in good working order. Empty recovery cylinders are evacuated and, if possible, cooled before recovery occurs. The recovery equipment shall be in good working order with a set of instructions concerning the equipment that is at hand and shall be suitable for the recovery of flammable refrigerants. In addition, a set of calibrated weighing scales shall be available and in good working order. Hoses shall be complete with leak-free disconnect couplings and in good condition. Before using the recovery machine, check that it is in satisfactory working order, has been properly maintained and that any associated electrical components are sealed to prevent ignition in the event of a refrigerant release. Consult manufacturer if in doubt. The recovered refrigerant shall be returned to the refrigerant supplier in the correct recovery cylinder, and the relevant Waste Transfer Note arranged. Do not mix refrigerants in recovery units and especially not in cylinders. If compressors or compressor oils are to be removed, ensure that they have been evacuated to an acceptable level to make certain that flammable refrigerant does not remain within the lubricant. The evacuation process shall be carried out prior to returning the compressor to the suppliers. Only electric heating to the compressor body shall be employed to accelerate this process. When oil is drained from a system, it shall be carried out safely.



## Features

- Enjoy 3 different fan speeds, a dehumidifier and a 62 ~ 95° F (16.6 ~ 35° C) temperature range for your comfort
- Remote with sensor lets you maintain or adjust the temperature even at a distance
- Timer functionality lets you set any temperature for a specific time of day or night
- Auto restart makes sure you're ready to go after a power outage
- 6 ft. (1.8 m) cord for easy reach to any nearby outlet
- Caster wheels for easy transport
- Fits horizontal sliding windows with a height of 19.4 to 62.2 in. (49.3 to 158 cm)
- Fits vertical sliding windows with a width of 19.4 to 62.2 in. (49.3 to 158 cm)
- NS-AC06PWH1: 6,000 BTU cooling capacity ideal for 150-250 sq. ft. (14 to 23 sq. m)
- NS-AC07PWH1: 7,000 BTU cooling capacity ideal for 250-300 sq. ft. (23 to 28 sq. m)
- NS-AC08PWH1: 8,000 BTU cooling capacity ideal for 300-350 sq. ft. (28 to 32.5 sq. m)

## Package contents

- Portable Air Conditioner (6,000 BTU, 7,000 BTU, or 8,000 BTU)
- Remote control with two AAA batteries
- Window installation kit
- *User Guide*

## Front

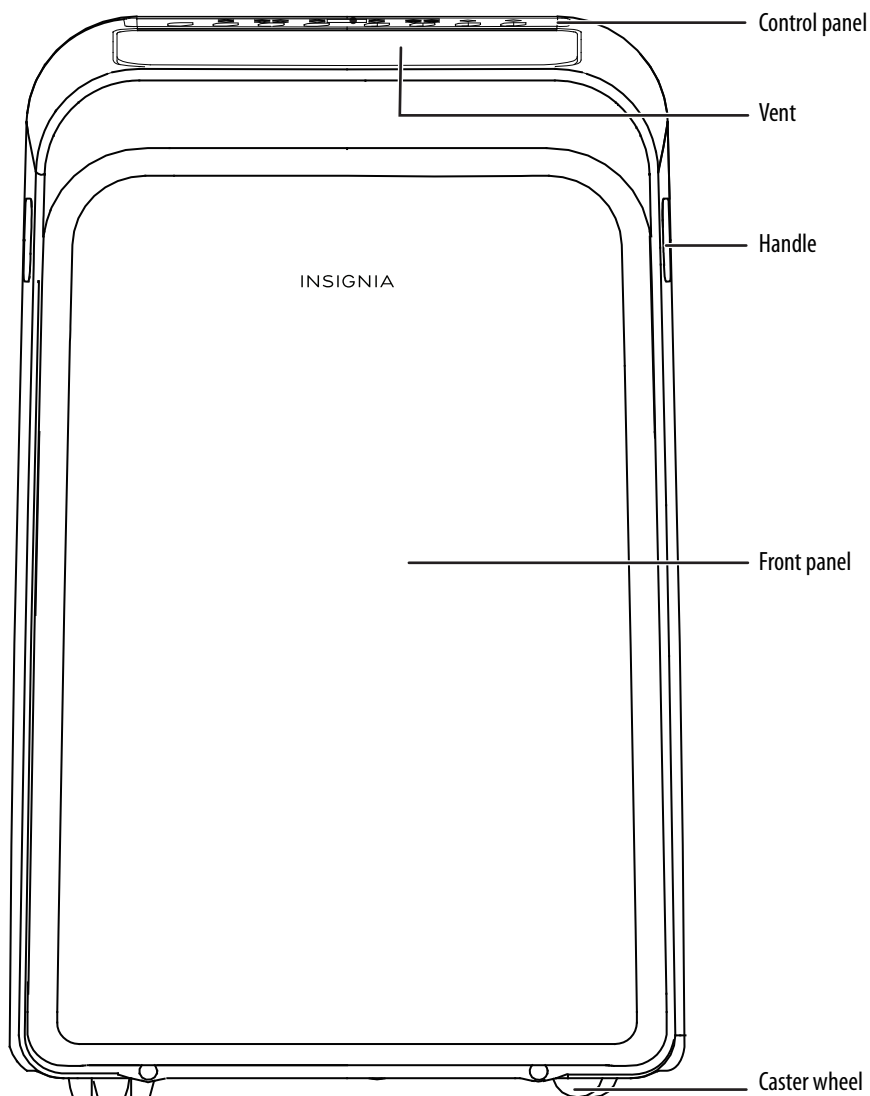

Back

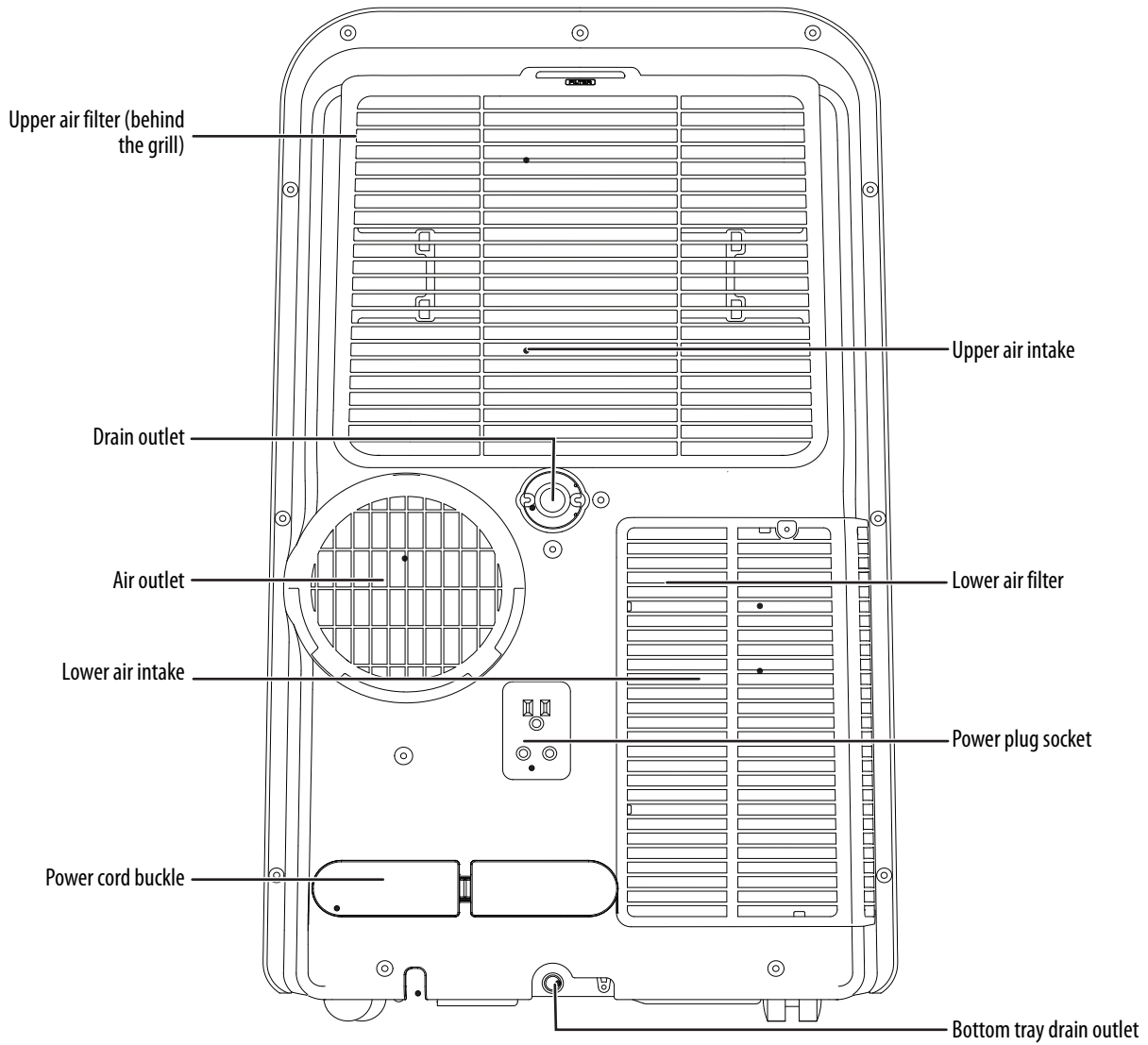

## Control panel

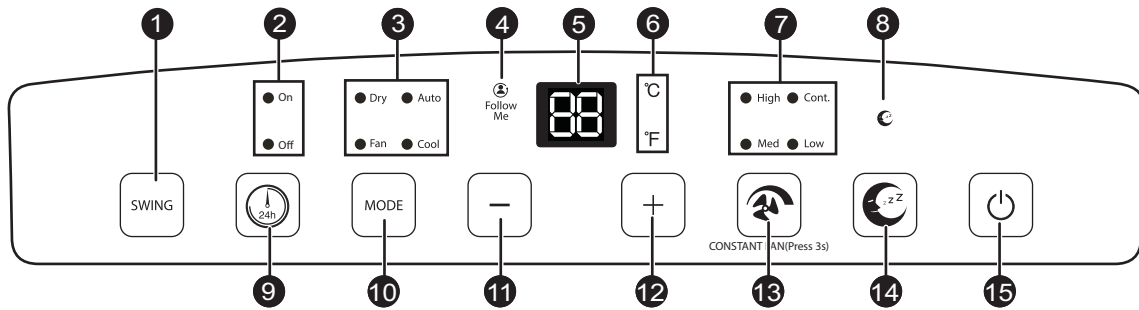

#	COMPONENT	DESCRIPTION
1	SWING button	Turns the vent swing movement on or off.
2	On/Off indicator	Lights when your air conditioner is turned on.
3	MODE indicators	Lights to indicate which operating mode is selected.
4	Follow Me indicator	Lights when the Follow Me feature is turned on. See <a href="#">Using the Follow Me feature</a> on page 24.
5	Display	When setting the timers, shows the number of hours selected. When your air conditioner is running, shows the current temperature setting or room temperature. When a problem occurs, shows an error or protection code.
6	Temperature format indicator	Lights to indicate the temperature format.
7	Fan speed indicator	Lights to indicate the current fan speed.
8	Sleep indicator	Lights when the Sleep feature is turned on. See <a href="#">Using the Sleep feature</a> on page 24.
9	(timer) button	Turns on the Timer feature. See <a href="#">Setting the timers</a> on page 23.
10	MODE button	Selects the operating mode. You can select <b>Dry</b> , <b>Auto</b> , <b>Fan</b> , or <b>Cool</b> . As you cycle through the modes, the corresponding mode indicators light. See <a href="#">Selecting the operating mode</a> on page 22.
11	- (decrease) button	Decreases the temperature setting. See <a href="#">Setting the operating temperature</a> on page 23.
12	+ (increase) button	Increases the temperature setting. See <a href="#">Setting the operating temperature</a> on page 23.
13	(fan) button	Selects the fan speed. You can select <b>High</b> , <b>Cont.</b> (continuous), <b>Med</b> , or <b>Low</b> . As you cycle through the speeds, the corresponding speed indicators light. See <a href="#">Adjusting the fan speed</a> on page 23.
14	(sleep) button	Turns the Sleep feature on or off. When this feature is turned on the corresponding indicator lights. See <a href="#">Using the Sleep feature</a> on page 24.
15	(power) button	Turns your air conditioner on or off.

## Ambient temperature range

MODE	TEMPERATURE RANGE
Cool	62° ~ 95° F (17° ~ 35° C)
Dry	55° ~ 95° F (13° ~ 35° C)

Remote control

**Note:** If you press a button for a feature that is not available, nothing happens.

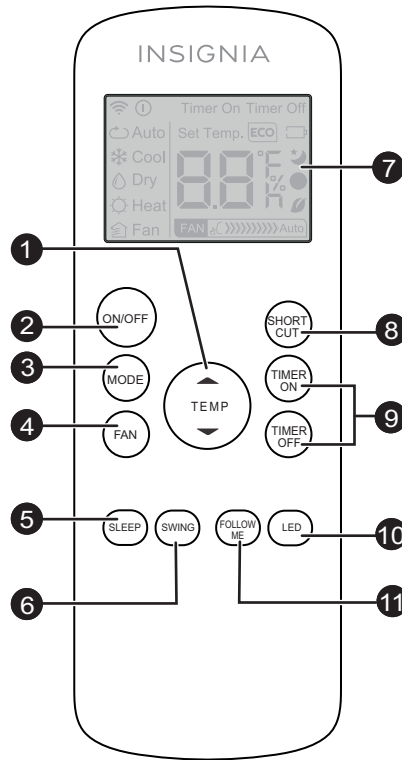

#	BUTTON	DESCRIPTION
1	TEMP ▲/TEMP ▼	Sets the temperature. This feature does not work in <b>Fan</b> mode. See <a href="#">Setting the operating temperature</a> on page 23.
2	ON/OFF	Turns your air conditioner on or off.
3	MODE	Selects the operating mode. You can select: <b>Auto</b> , <b>Cool</b> , <b>Dry</b> , or <b>Fan</b> . See <a href="#">Selecting the operating mode</a> on page 22.
4	FAN	Selects the fan speed. You can select: <b>Auto</b> , <b>Low</b> , <b>Med</b> , or <b>High</b> . See <a href="#">Adjusting the fan speed</a> on page 23.
5	SLEEP	Reduces the amount of energy your air condition uses without changing the operating mode. This feature does not work in <b>Dry</b> or <b>Fan</b> mode. See <a href="#">Using the Sleep feature</a> on page 24.
6	SWING	Starts and stops the vent movement. See <a href="#">Controlling the vent</a> on page 23.
7	Display	Displays indicators and status information. See <a href="#">Remote control display</a> on page 14.
8	SHORT CUT	Stores and activates your favorite settings. See <a href="#">Setting the shortcut</a> on page 24.
9	TIMER ON/TIMER OFF	Turns the Timer feature on or off. See <a href="#">Setting the timers</a> on page 23.
10	LED	Turns the display on your air conditioner on or off. See <a href="#">Turning the control panel display on or off</a> on page 24.
11	FOLLOW ME	Lets the remote control measure and send the room temperature to your air conditioner. See <a href="#">Using the Follow Me feature</a> on page 24.

**Installing remote control batteries**

- 1 Press down on the remote control battery cover and slide the cover off the remote control.
- 2 Insert two AAA batteries (included) into the battery compartment. Make sure that the + marks on the batteries align with the + marks in the compartment.

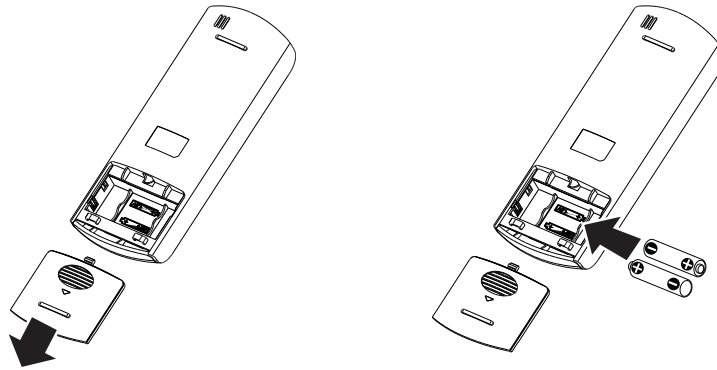

- 3 Replace the cover.

**CAUTIONS:**

- Batteries should not be exposed to excessive heat, such as sunshine, heat registers, or fire.
- Battery chemicals can cause a rash. If the batteries leak, clean the battery compartment with a cloth. If chemicals touch your skin, wash immediately.
- Make sure that batteries are disposed of correctly. Do not burn or incinerate.

**Notes:**

- Do not mix batteries of different types.
- Do not mix old and new batteries.
- Remove batteries when the charge is depleted.
- If the remote control is not going to be used for an extended period of time, remove the batteries.

Remote control display

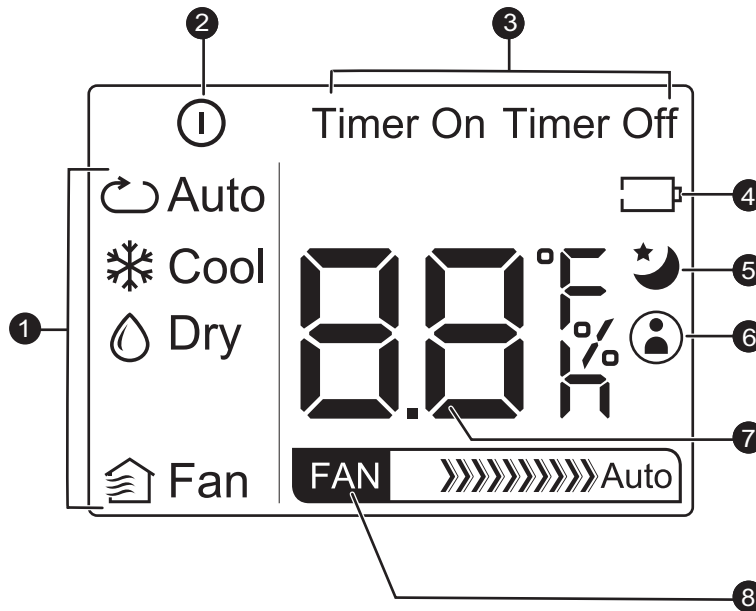

#	INDICATOR	DESCRIPTION
1	Operating mode	Lights to indicate the selected mode: <b>Auto</b> , <b>Cool</b> , <b>Dry</b> , or <b>Fan</b> .
2	Power indicator	Lights when your air conditioner is turned on.
3	Timer On/Timer Off	<b>Timer On</b> appears when the timers are set. <b>Timer Off</b> appears when the timers are not set.
4	Low battery indicator	Lights when your air conditioner detects low battery power in the remote control batteries.
5	Sleep indicator	Lights when the Sleep feature is turned on.
6	Follow Me	Lights when the Follow Me feature is turned on.
7	Display	Show the current temperature setting. When a timer is turned on, shows the timer setting.
8	Fan speed	Shows the current fan speed setting. >>>>>>>>> indicates high. >>>>>> indicates medium. >>> indicates low. This indicator does not appear in <b>Auto</b> mode.

# Before installing your air conditioner

## Finding a suitable location

Make sure that:

- You install your air conditioner on an even surface to minimize noise and vibration.
- Your air conditioner is installed near a grounded plug.
- You can access the collection tray drain on the back of your air conditioner.
- Your air conditioner is at least 19.7" (50 cm) for the nearest walls.
- The horizontal vent is 19.7 in. (50 cm) away from any obstacles.
- The intake and outlet openings and the remote control sensor are not covered or blocked.

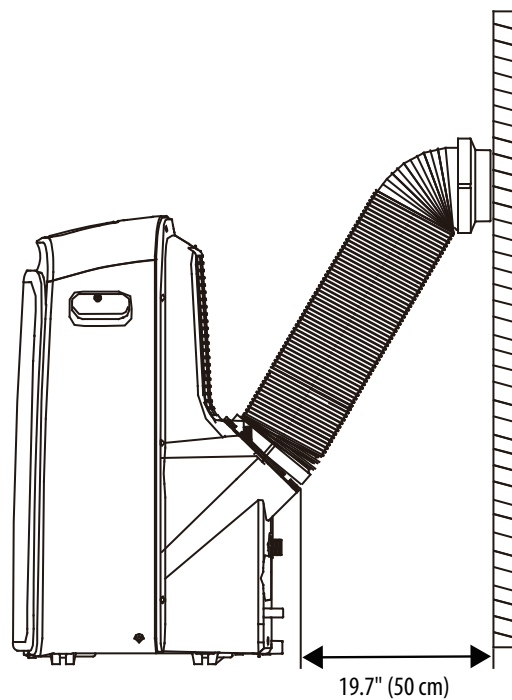
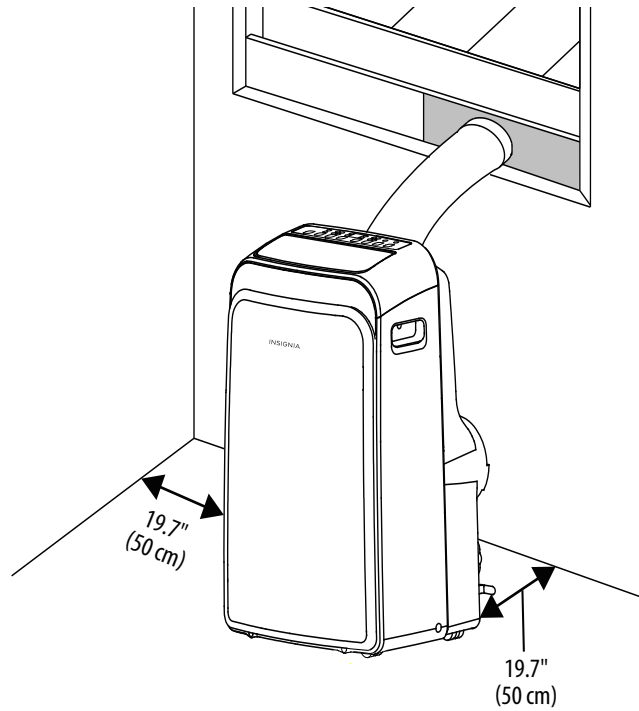



**Providing the correct power source**

Check your local power source. Your air conditioner requires a 115V, 60Hz power supply.

**WARNINGS:**

Make sure that:

- The power outlet accepts a 3-prong grounding plug. The third prong on the power cord plug grounds your air conditioner to minimize the possibility of electric shock. Do not modify the power plug.
- You do NOT plug anything else into the same power outlet as your air conditioner. You may overload the circuit which can cause a fire.
- You do NOT use an extension cord. If your air conditioner is too far from the power outlet, move your air conditioner or have an electrician install a plug closer to your air conditioner.
- The power outlet can't be turned off with a switch or pull string.

Using a 3-prong plug and outlet

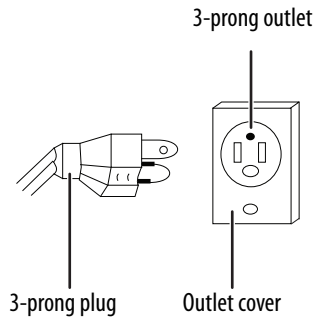

Using a grounding adapter

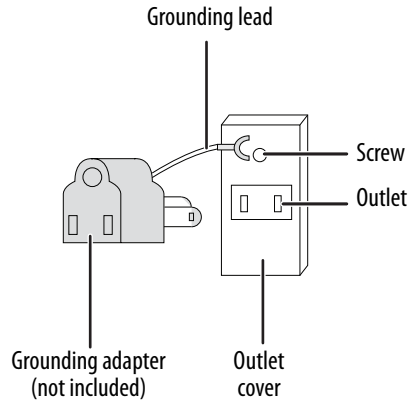

**Installing your air conditioner**

**Tools you need (not included)**

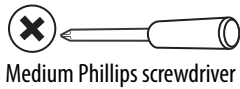

Medium Phillips screwdriver

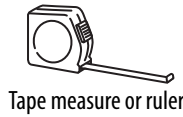







Tape measure or ruler







Scissors or knife

### Window installation kit

The window installation kit fits windows 19.4" ~ 62.2" (49.3 ~ 158.1 cm).

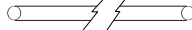
HARDWARE	QTY.
 Unit adapter	1
 Exhaust hose	1
 Air exhaust passage	1
 Window slides	1
 Foam seal A (adhesive)	4
 Foam seal B (adhesive)	2

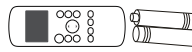
HARDWARE	QTY.
 Foam seal C (non-adhesive)	2
 Security bracket with screws (2) set	1
 Drain hose	1
 Power cord buckle	1
 Bolt	3
 Remote control with 2 AAA batteries	1

### STEP 1: Connect the exhaust hose to your air conditioner

#### You need

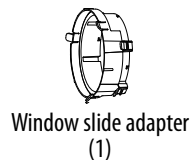
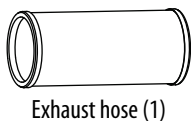

- 1 Press the exhaust hose into the air exhaust passage and the unit adapter. The elastic buckles on the adapters automatically secure the hose to the adapters.

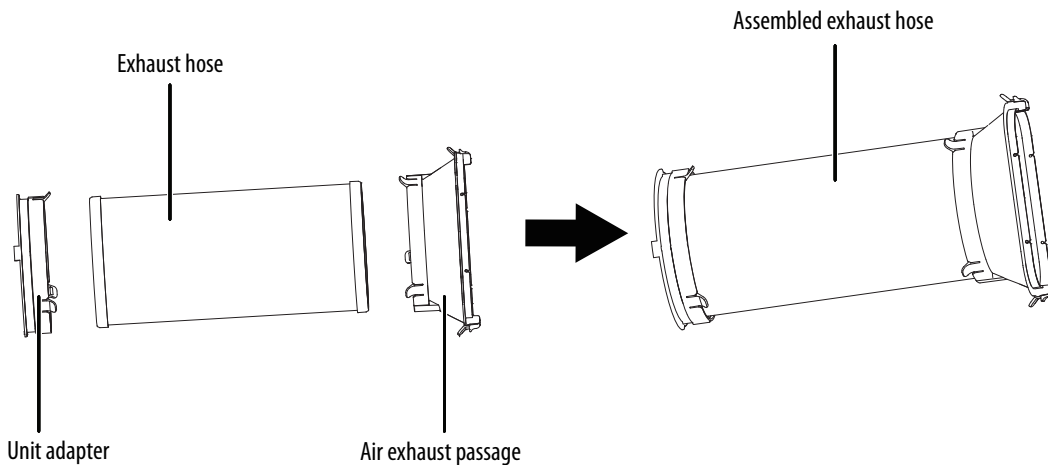

- 2 Insert unit adapter on the assembled exhaust hose into the lower groove on the air outlet on your air conditioner.
- 3 Make sure that the hook on the adapter aligns with the notch on the air outlet, then press the adapter into the notch to lock it in place.

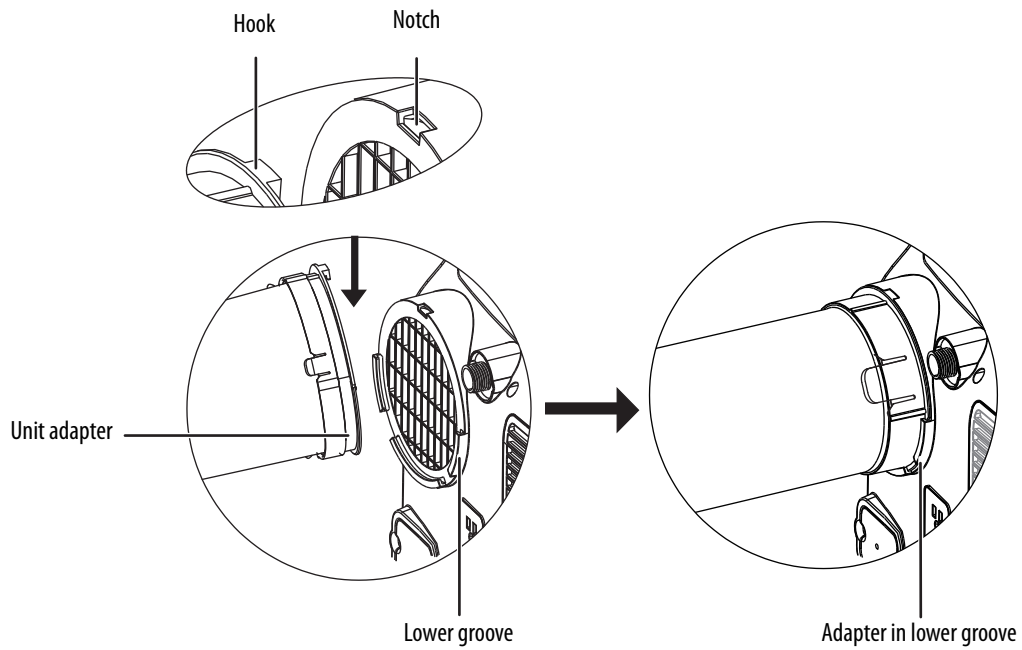

## STEP 2: Assembling the adjustable window slides

**Note:**

- Your air conditioner comes with three slides (A, B, and C). Depending on the size of the window, you may need two or more slides.
- You may need to cut a slide to fit your window. Double-check the length before you cut.

### You need

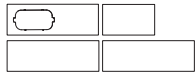

Window slides



Bolt (optional)  
(3)

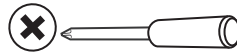

Phillips screwdriver  
(not included)

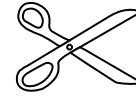

Scissors or knife  
(not included)

- 1 Select the window slides that fit your window. You may need to trim the slides to fit your window.

**Note:** You must use slide A because it has the opening for the exhaust hose.

- 2 After you adjust the slides to the correct length, use bolts to secure them.

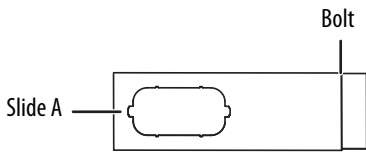

Slides A and B

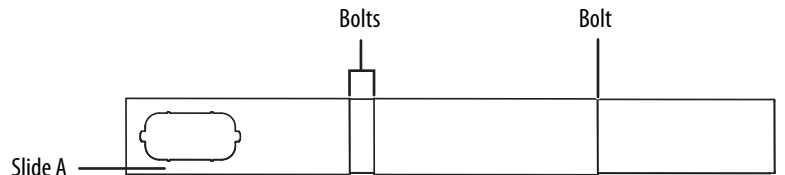

Slides A, B, C, and D

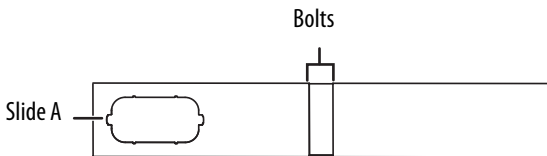

Slides A, B, and C

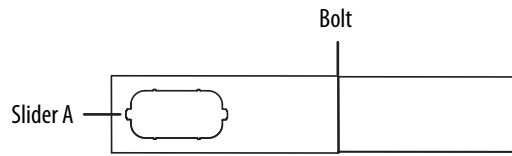

Slides A and D

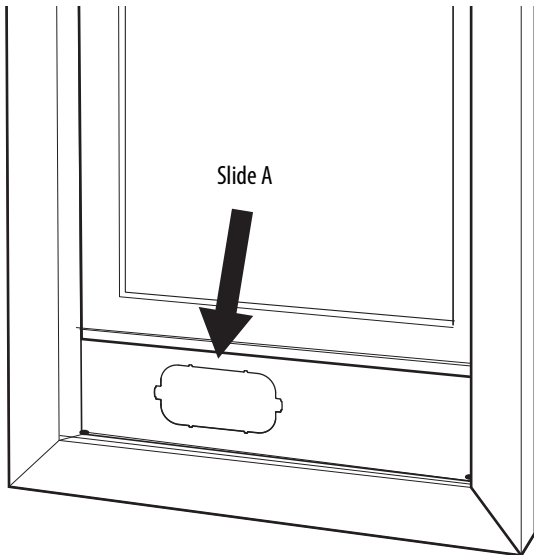

Hung window

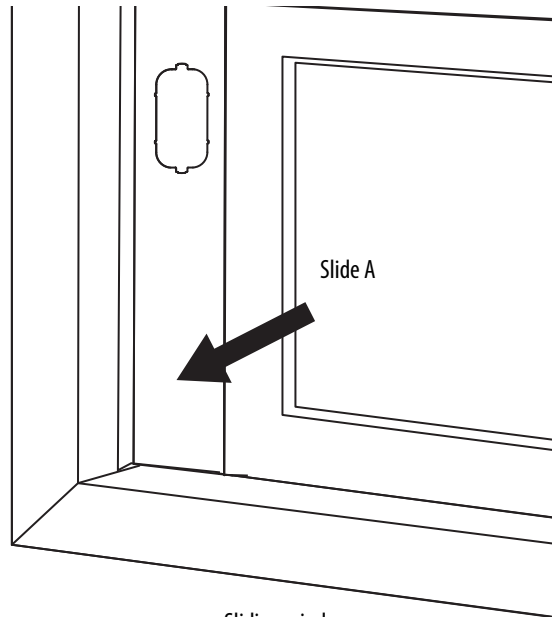

Sliding window

**STEP 3: Preparing the window frame and sash**

**Note:**

- If you are installing your air conditioner in a window that opens vertically (a hung window), install the slides horizontally.
- If you are installing your air conditioner in a window that opens horizontally (a sliding window), install the slides vertically.

**You need**

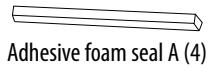

Adhesive foam seal A (4)

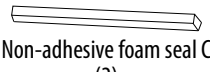

Non-adhesive foam seal C (2)

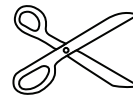

Scissors or knife (not included)

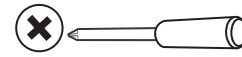

Phillips screwdriver (not included)

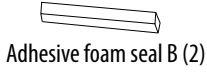

Adhesive foam seal B (2)



Security bracket and screws (optional) (1)

- 1 Cut the adhesive foam seals A and B to fit the window frame and sash.
- 2 Remove the seal backings, then press the adhesive sides onto the frame and sash.

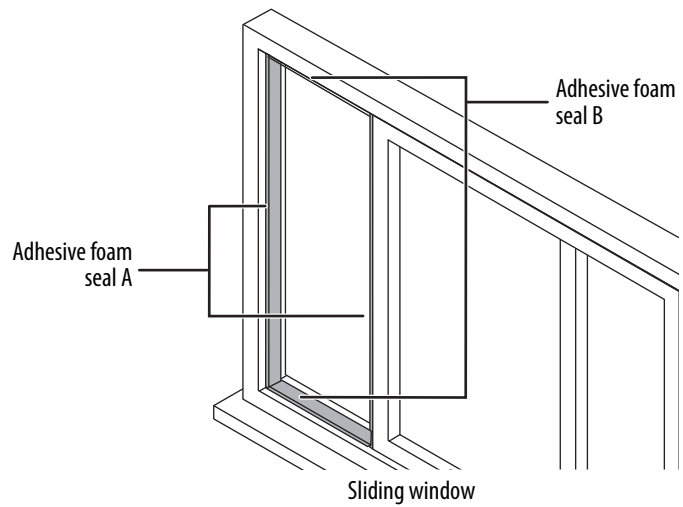
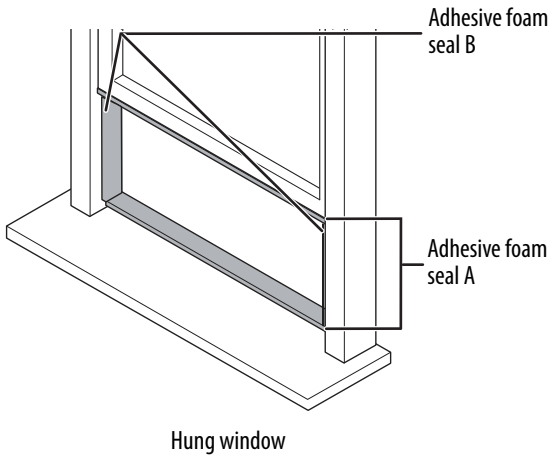

- 3 Insert the assembled window slide into the window.

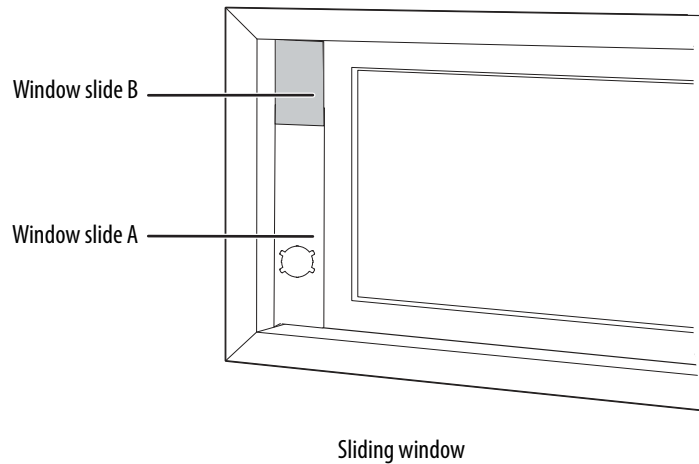
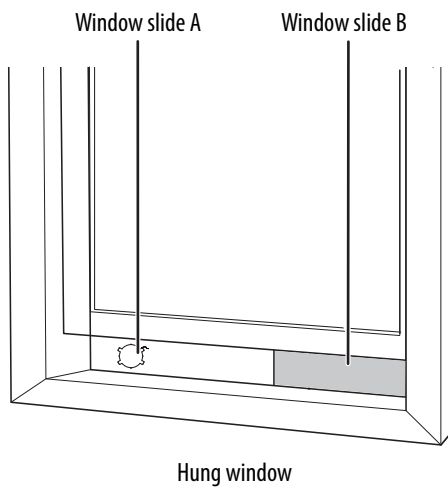

- 4 Cut the non-adhesive foam C to fit the width (hung window) or height (sliding window) of the window, then insert the foam between the glass and the window frame to prevent air and insects from getting into the room.

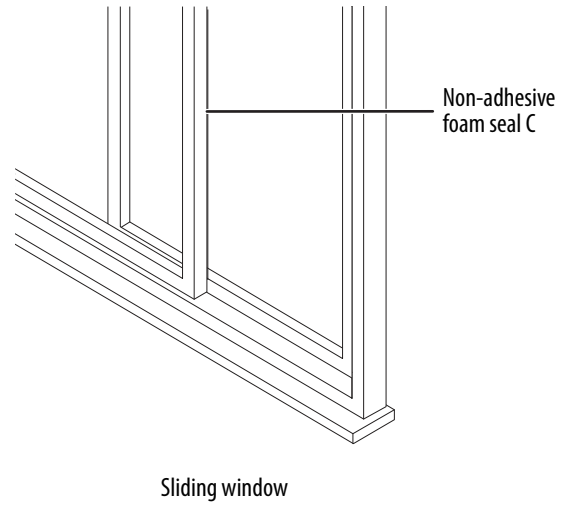
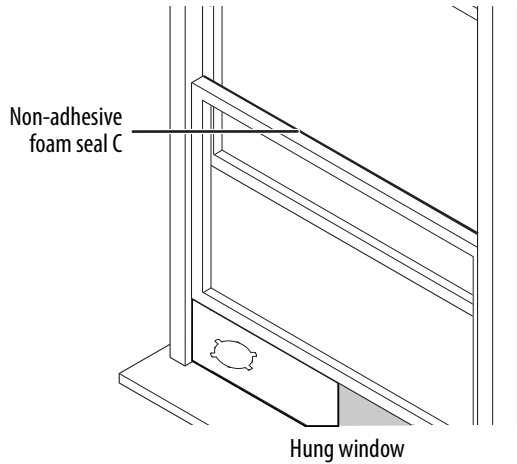

- 5 **Optional:** Install the security bracket using two screws. The security bracket helps keep the window from moving.

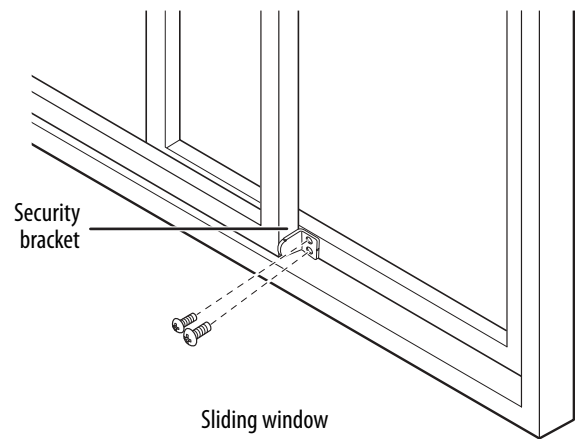
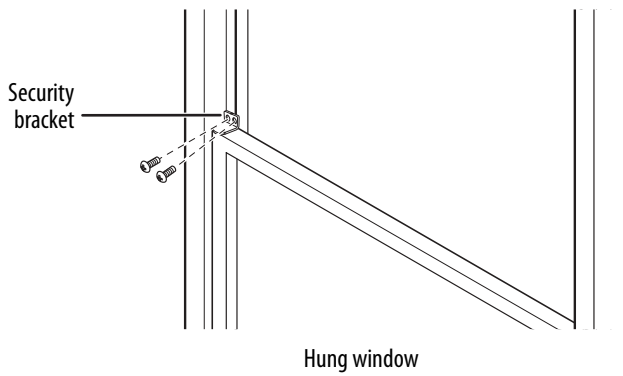

**STEP 4: Connecting the assembled exhaust hose to the window**

**CAUTION:**

- To make sure that your air conditioner is exhausted correctly:
- Do not overextend or bend the exhaust hose.
  - Remove any obstacles within 20 in. (50 cm) of the exhaust hose.

- Insert the window slide adapter on the end of the exhaust hose assembly into the hole on the window slide A.

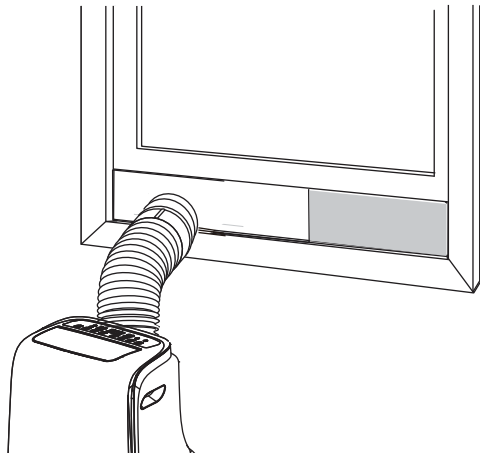

Hung window

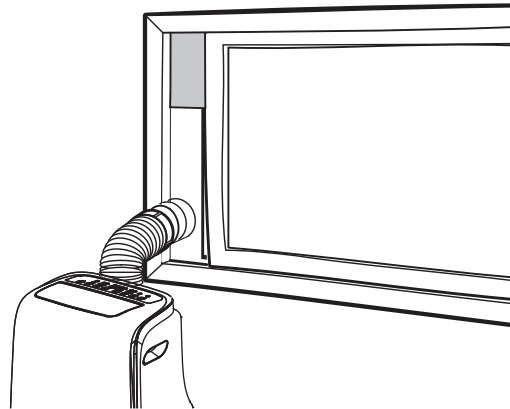

Sliding window

**Using your air conditioner**

**Turning your air conditioner on or off**

**Note:** When you turn off your air conditioner, it won't turn on again for three minutes. This is to protect your air conditioner.





- Press the  (power) button on the control panel or **ON/OFF** button on the remote control.

**Auto restart**

If your air conditioner turns off unexpectedly because of a power failure, it automatically restarts three minutes after the power is restored.

**Selecting the operating mode**

- Press the **MODE** button on the control panel or remote control one or more times until the icon for the mode appears on the control panel and remote control displays. You can select:

MODE	Description
Auto 	Automatically selects <b>Cool</b> or <b>Fan</b> mode depending on the temperature setting and the room temperature. <b>Note:</b> In <b>Auto</b> mode you can't set the fan speed.
Cool 	Cools the air to the temperature you set. See <a href="#">Setting the operating temperature</a> on page 23.
Dry 	Turns on the dehumidifier feature. In this mode, you can't adjust the temperature or select a fan speed. The fan runs at low speed. See <a href="#">Using the dehumidifier feature</a> on page 25. <b>Note:</b> Don't connect or disconnect the exhaust hose while in <b>Dry</b> mode.
Fan  or 	Blows air only without cooling. <b>Note:</b> Don't connect or disconnect the exhaust hose while in <b>Fan</b> mode.



## Setting the operating temperature

### Notes:

- The operating temperature range for your air conditioner is 62° ~ 86° F (17° ~ 30° C).
- You can't adjust the temperature in the **DRY** operating mode.

- 1 Press the **MODE** button on the control panel or remote control to cycle through the operating modes. You can select: **Auto**, **Fan**, or **Cool**.  
As you cycle through the modes, the corresponding mode indicators light on the control panel and remote control displays.
- 2 Press the + or – button on the control panel or the **TEMP ▲** or **▼** button on the remote control to increase or decrease the temperature. Each time you press a button, the temperature increases or decreases by 1° F (1° C).



## Setting the temperature format

Your air conditioner can display the temperature in degrees Fahrenheit (F) or Celsius (C).

- To toggle between Fahrenheit (F) or Celsius (C), press and hold the + and – buttons on the control panel or the **TEMP ▲** and **▼** buttons on the remote control at the same time for three seconds. The °C or °F indicator lights on the control panel.

## Adjusting the fan speed

**Note:** If the operating mode is set to **Auto**, you can't change the fan speed.

- Press the  (fan) button on the control panel or the **FAN** button on the remote control. Each time you press the button, the fan speed changes. You can select **Low**, **Med**, **High**, or **Auto**. The corresponding indicator lights on the control panel and remote control display.  
In the **Cool** or **Dry** operating mode, you can press and hold the  (fan) button on the control panel or the **FAN** button on the remote control to make the fan run continuously. The Cont. indicator lights on the control panel. Press and hold the button again to turn off this feature.

## Controlling the vent

You make the vent move up and down continuously or you can adjust it to the angle you want.

**CAUTION:** Do not manually adjust the vent angle. You can damage the vent.

- 1 Make sure that your air conditioner is turned on, then press the **SWING** button on the control panel or remote control. The vent automatically moves up and down.
- 2 When the vent is at the angle you want, press the **SWING** button again. The vent movement stops with the vent in the current position.



## Setting the timers

You can set timers to turn your air conditioners on and off automatically.



**Note:** The number on the display indicates the number of hours after the current time that you want your air conditioner to turn on. For example, if you set the timer for two hours, "2.0h" appears on the display and your air conditioner turns on after two hours.

### Using the control panel on your air conditioner

If your air conditioner is on turned on:

- 1 Press the  (timer) button to turn on the OFF timer. The **off** indicator lights.
- 2 Press the + or – button to select the time.
- 3 If you want to set the ON timer, after five seconds, press the  (timer) button again, then use the + or – button to select the time. For the first 10 hours, the time changes in 30 minute increments, then switches to 1 hour increments up to 24 total hours.
- 4 To turn the timer off, turn your air conditioner on or off or reset the timer to 0.0.

If your air conditioner is turned off:

- 1 Press the  (timer) button to turn on the ON timer. The **on** indicator lights.
- 2 Press the + or – button to select the time.
- 3 If you want to set the ON timer, after five seconds, press the  (timer) button again, then use the + or – button to select the time. For the first 10 hours, the time changes in 30 minute increments, then switches to 1 hour increments up to 24 total hours.
- 4 To turn the timer off, turn your air conditioner on or off or reset the timer to 0.0.

### Using the remote control

- 1 Press the **TIMER ON** (to set the ON timer) or **TIMER OFF** button (to set the OFF timer).
- 2 Press the **TIMER ON** or **TIMER OFF** button repeatedly to set the number of hours you want, then wait for two seconds. The timer turns on and the temperature setting appears in the display.
- 3 To turn the timer off, turn your air conditioner on or off or reset the timer to 0.0.

### Using the Sleep feature

**Note:** The Sleep feature is not available in the **FAN** or **DRY** operating mode.

The Sleep feature helps save energy by adjusting the temperature up one degree in **Cool** mode.

- Press the  button on the control panel or the **SLEEP** button on the remote control. After seven hours, the **Sleep** feature turns off and your air conditioner returns to the programmed temperature setting.

### Setting the shortcut

You can store your favorite settings using the **SHORTCUT** button on the remote control.

- 1 Press the **SHORTCUT** button on the remote control to save the current settings, including the operating mode, temperature setting, fan speed, and Sleep feature (if turned on).
- 2 When settings have changed, press the **SHORTCUT** button for more than two seconds. Your air conditioner returns to the saved settings.

### Turning the control panel display on or off

- Press the **LED** button on the remote control to turn the control panel display on or off.

### Using the Follow Me feature

**Notes:**

- You can only turn on the Follow Me feature with the remote control.
- The Follow Me feature is not available in the **Fan** or **Dry** operating mode.

When you turn on the Follow Me feature, the remote control serves as a remote thermostat and sends a temperature reading of the area around the remote control location to your air conditioner. Your air conditioner uses this reading to optimize the temperature around the remote control.

- Press the **FOLLOW ME** button on the remote control to turn this feature on or off.

**Note:** If your air conditioner does not receive the temperature reading for seven minutes, the Follow Me feature turns off.

## Using the dehumidifier feature

**Note:** You can't change the fan speed in the **Dry** operating mode.

You can use your air conditioner as a dehumidifier to remove moisture from the air.

- 1 If the exhaust hose is installed, remove it.
- 2 Make sure that all windows and doors are closed.
- 3 Set your air conditioner to the **Dry** operating mode. See [Selecting the operating mode](#) on page 22.
- 4 Remove the upper drain plug, then connect a 3/4 in. hose (not included) to the drain hole.

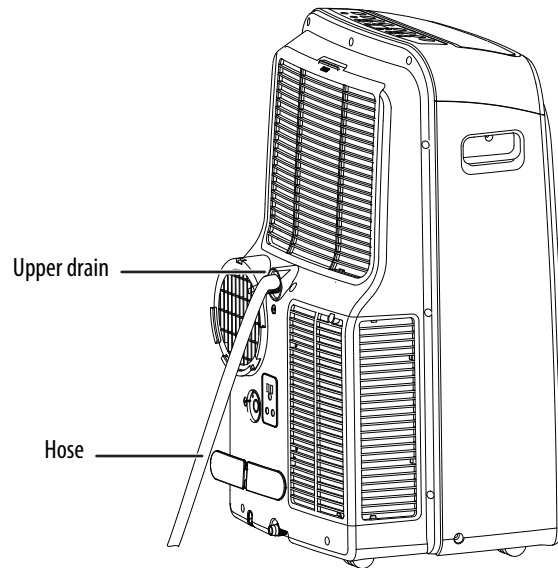

- 5 Place the other end of the hose into a drain or other type of container for the water to drain into.
- 6 Turn your air conditioner on.

## Maintaining your air conditioner

### Safety guidelines

- Always unplug your air conditioner before cleaning or servicing.
- DO NOT use flammable liquids or chemicals to clean your air conditioner.
- DO NOT wash your air conditioner under running water. Doing so causes electrical danger.
- DO NOT run your air conditioner if the power supply is damaged during cleaning. You must replace a damaged power cord.

### Cleaning the exterior

- 1 Clean the exterior with a damp, lint-free cloth and mild detergent, then rinse with a damp cloth.
- 2 Dry your air conditioner with a lint-free cloth.

## Cleaning the air filter

**CAUTION:** Don't run your air conditioner without the filter. Dust and lint can accumulate inside and reduce performance.

**Notes:**

- For the best performance, clean the air filter every two weeks.
- Wipe the grill periodically to prevent blocked air flow.

- 1 Carefully pull the top of the grill away from your air conditioner, then pull the air filter up and out.

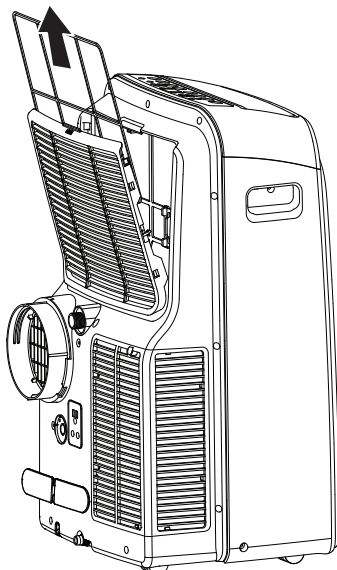

- 2 Wash the filter in warm, soapy water, then let it dry.
- 3 Put the filter back in your air conditioner, then snap the grill back in place.

## Emptying the drain tray

When the drain tray is full, your air conditioner beeps eight times, *P1* appears on the control panel display, and your air conditioner stops. The motor continues to run.

- 1 Carefully move your air conditioner to a drain location, then remove the bottom drain plug and let the water drain away. If you don't have a drain, use a cookie with sides or a shallow dish.

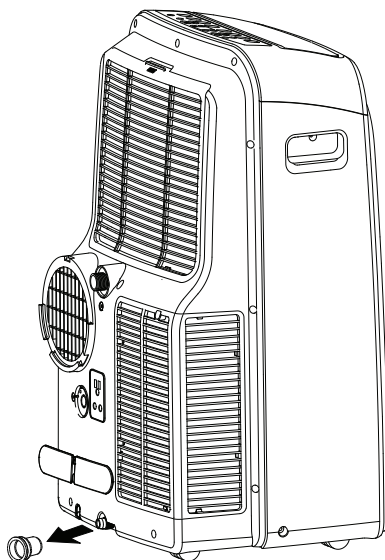

- 2 Reinstall the bottom drain plug. Make sure that you reinstall it firmly to prevent leakage.
- 3 Restart your air conditioner. The *P1* disappears. If the error repeats, call a qualified technician to service.

## Storing your air conditioner

**CAUTION:** Store your air conditioner in a cool, dark place. Exposure to direct sunshine or extreme heat can shorten the lifespan of your air conditioner.

- 1 Run the fan for 12 hours, then empty the drain tray. See [Emptying the drain tray](#) on page 26.
- 2 Run your air conditioner in FAN mode for 12 hours in a warm room to dry it and prevent mold.
- 3 Turn off and unplug your air conditioner.
- 4 Clean and reinstall the air filter. See [Cleaning the air filter](#) on page 26.
- 5 Remove the batteries from the remote control.

## Troubleshooting

PROBLEM	POSSIBLE CAUSE	POSSIBLE SOLUTION
My air conditioner doesn't turn off when I press the  or ON/OFF button	P1 Error Code.	The water collection tray is full. Turn off your air conditioner, drain the water from the tray, then restart your air conditioner. See <a href="#">Emptying the drain tray</a> on page 26.
	Your air conditioner is set to the <b>Cool</b> mode, and the room temperature is lower than the set temperature.	Reset the temperature. See <a href="#">Setting the operating temperature</a> on page 23.
My air conditioner doesn't cool well	The temperature setting is too high.	Set the temperature to a lower setting. See <a href="#">Setting the operating temperature</a> on page 23.
	The air filter is blocked with dust or animal hair.	Turn off your air conditioner, then clean the filter. See <a href="#">Cleaning the air filter</a> on page 26.
	The windows or doors in the room are open.	Close the windows or doors.
	There are heat sources in the room.	Remove the heat sources.
	The room area is too large.	The recommended room areas are: <ul style="list-style-type: none"> <li>• NS-AC06PWH1: 150-250 sq. ft.</li> <li>• NS-AC07PWH1: 250-300 sq. ft.</li> <li>• NS-AC08PWH1: 300-350 sq. ft.</li> </ul>
	The exhaust hose isn't connected or is blocked.	Turn off your air conditioner, disconnect the hose, check for blockage, then reconnect the hose. See <a href="#">STEP 1: Connect the exhaust hose to your air conditioner</a> on page 17.
The refrigerant level is low.	Contact a qualified service technician to check your air conditioner and add refrigerant.	
My air conditioner is noisy and vibrates	The floor is not level.	Place your air conditioner on a flat, level surface.
	The air filter is blocked with dust or animal hair.	Turn off your air conditioner, then clean the filter. See <a href="#">Cleaning the air filter</a> on page 26.
My air conditioner makes a gurgling sound	This sound is caused by the flow of refrigerant inside your air conditioner.	This is normal.

## Error codes

Your air conditioner displays error and protection codes on the control panel display to help you resolve problems.

**Note:** When an error occurs, turn off your air conditioner, check for obstructions, then turn it back on. If the error reoccurs, turn off and unplug your air conditioner. Contact a qualified technician for service.

ERROR CODE	DESCRIPTION
E1	Room temperature sensor error.
E2	Evaporator temperature sensor error.
E3	Condenser temperature sensor error.
E4	Display panel communication error.
EC	Refrigerant leakage detection malfunction.
P1	Bottom tray is full. Connect the drain hose and drain the collected water away. See <a href="#">Emptying the drain tray</a> on page 26.

## Specifications

Specifications are subject to change without notice.

Dimensions (W × D × H)	27.5 H × 17.8 W × 14.3 D in. (70 × 45.4 × 36.5 cm)
Weight	NS-AC06PWH1 (6,000 BTU): 59 lbs. (26.8 kg) NS-AC07PWH1 (7,000 BTU): 61.9 lbs. (28.1 kg) NS-AC08PWH1 (8,000 BTU): 68.1 lbs (30.9 kg)
Operating temperature range	62° to 86° F (17° to 30° C)
Power requirements	AC115 V ~ 60 Hz
Power cord length	74.8 in. (1.9 m)

## Legal notices

### FCC Part 15

This device complies with Part 15 of the FCC Rules. Operation of this product is subject to the following two conditions: (1) this device may not cause harmful interference, and (2) this device must accept any interference received, including interference that may cause undesired operation.

This equipment has been tested and found to comply within the limits for a class B digital device, pursuant to Part 15 of the FCC Rules. These limits are designed to provide reasonable protection against harmful interference in a residential installation. This equipment generates, uses, and can radiate radio frequency energy and, if not installed and used in accordance with the instructions, may cause harmful interference to radio communications. However, there is no guarantee that interference will not occur in a particular installation. If this equipment does cause harmful interference to radio or television reception, which can be determined by turning the equipment off and on, the user is encouraged to try to correct the interference by one or more of the following measures:

- Reorient or relocate the receiving antenna.
- Increase the separation between the equipment and receiver.
- Connect the equipment into an outlet on a circuit different from that to which the receiver is connected.

Consult the dealer or an experienced technician for help.

### FCC Warning

Changes or modifications not expressly approved by the party responsible for compliance with the FCC Rules could void the user's authority to operate this equipment.

# ONE-YEAR LIMITED WARRANTY

## Definitions:

The Distributor\* of Insignia branded products warrants to you, the original purchaser of this new Insignia-branded product ("Product"), that the Product shall be free of defects in the original manufacture of the material or workmanship for a period of one (1) year from the date of your purchase of the Product ("Warranty Period").

For this warranty to apply, your Product must be purchased in the United States or Canada from a Best Buy branded retail store or online at [www.bestbuy.com](http://www.bestbuy.com) or [www.bestbuy.ca](http://www.bestbuy.ca), and is packaged with this warranty statement.

## How long does the coverage last?

The Warranty Period lasts for 1 year (365 days) from the date you purchased the Product. Your purchase date is printed on the receipt you received with the Product.

## What does this warranty cover?

During the Warranty Period, if the original manufacture of the material or workmanship of the Product is determined to be defective by an authorized Insignia repair center or store personnel, Insignia will (at its sole option): (1) repair the Product with new or rebuilt parts; or (2) replace the Product at no charge with new or rebuilt comparable products or parts. Products and parts replaced under this warranty become the property of Insignia and are not returned to you. If service of Products or parts are required after the Warranty Period expires, you must pay all labor and parts charges. This warranty lasts as long as you own your Insignia Product during the Warranty Period. Warranty coverage terminates if you sell or otherwise transfer the Product.

## How to obtain warranty service?

If you purchased the Product at a Best Buy retail store location, please take your original receipt and the Product to any Best Buy store. Make sure that you place the Product in its original packaging or packaging that provides the same amount of protection as the original packaging. If you purchased the Product from a Best Buy online web site ([www.bestbuy.com](http://www.bestbuy.com) or [www.bestbuy.ca](http://www.bestbuy.ca)), mail your original receipt and the Product to the address listed on the web site. Make sure that you put the Product in its original packaging or packaging that provides the same amount of protection as the original packaging.

To obtain warranty service, in the United States call 1-888-BESTBUY, Canada call 1-866-BESTBUY. Call agents may diagnose and correct the issue over the phone.

## Where is the warranty valid?

This warranty is valid only in the United States and Canada at Best Buy branded retail stores or websites to the original purchaser of the product in the country where the original purchase was made.

## What does the warranty not cover?

This warranty does not cover:

- Food loss/spoilage due to failure of refrigerator or freezer
- Customer instruction/education
- Installation
- Set up adjustments
- Cosmetic damage
- Damage due to weather, lightning, and other acts of God, such as power surges
- Accidental damage
- Misuse
- Abuse
- Negligence
- Commercial purposes/use, including but not limited to use in a place of business or in communal areas of a multiple dwelling condominium or apartment complex, or otherwise used in a place of other than a private home.
- Modification of any part of the Product, including the antenna
- Display panel damaged by static (non-moving) images applied for lengthy periods (burn-in).
- Damage due to incorrect operation or maintenance
- Connection to an incorrect voltage or power supply
- Attempted repair by any person not authorized by Insignia to service the Product
- Products sold "as is" or "with all faults"
- Consumables, including but not limited to batteries (i.e. AA, AAA, C etc.)
- Products where the factory applied serial number has been altered or removed
- Loss or Theft of this product or any part of the product
- Display panels containing up to three (3) pixel failures (dots that are dark or incorrectly illuminated) grouped in an area smaller than one tenth (1/10) of the display size or up to five (5) pixel failures throughout the display. (Pixel based displays may contain a limited number of pixels that may not function normally.)
- Failures or Damage caused by any contact including but not limited to liquids, gels or pastes.

REPAIR REPLACEMENT AS PROVIDED UNDER THIS WARRANTY IS YOUR EXCLUSIVE REMEDY FOR BREACH OF WARRANTY. INSIGNIA SHALL NOT BE LIABLE FOR ANY INCIDENTAL OR CONSEQUENTIAL DAMAGES FOR THE BREACH OF ANY EXPRESS OR IMPLIED WARRANTY ON THIS PRODUCT, INCLUDING, BUT NOT LIMITED TO, LOST DATA, LOSS OF USE OF YOUR PRODUCT, LOST BUSINESS OR LOST PROFITS. INSIGNIA PRODUCTS MAKES NO OTHER EXPRESS WARRANTIES WITH RESPECT TO THE PRODUCT, ALL EXPRESS AND IMPLIED WARRANTIES FOR THE PRODUCT, INCLUDING, BUT NOT LIMITED TO, ANY IMPLIED WARRANTIES OF AND CONDITIONS OF MERCHANTABILITY AND FITNESS FOR A PARTICULAR PURPOSE, ARE LIMITED IN DURATION TO THE WARRANTY PERIOD SET FORTH ABOVE AND NO WARRANTIES, WHETHER EXPRESS OR IMPLIED, WILL APPLY AFTER THE WARRANTY PERIOD. SOME STATES, PROVINCES AND JURISDICTIONS DO NOT ALLOW LIMITATIONS ON HOW LONG AN IMPLIED WARRANTY LASTS, SO THE ABOVE LIMITATION MAY NOT APPLY TO YOU. THIS WARRANTY GIVES YOU SPECIFIC LEGAL RIGHTS, AND YOU MAY ALSO HAVE OTHER RIGHTS, WHICH VARY FROM STATE TO STATE OR PROVINCE TO PROVINCE.

Contact Insignia:

For customer service please call 1-877-467-4289

[www.insigniaproducts.com](http://www.insigniaproducts.com)

INSIGNIA is a trademark of Best Buy and its affiliated companies.

Distributed by Best Buy Purchasing, LLC

7601 Penn Ave South, Richfield, MN 55423 U.S.A.

©2019 Best Buy. All rights reserved.



INSIGNIA™

**For product inquiries, please contact us with the information below:**

**1-877-467-4289**

**[www.insigniaproducts.com](http://www.insigniaproducts.com)**

INSIGNIA is a trademark of Best Buy and its affiliated companies.

Distributed by Best Buy Purchasing, LLC

7601 Penn Ave South, Richfield, MN 55423 U.S.A.

©2019 Best Buy. All rights reserved.

V1 ENGLISH  
19-0641