

200W SOLAR PANEL BRIEFCASE

INSTRUCTION MANUAL & WARRANTY

MODEL G200

PN: FLC-G2-182000-P200-B

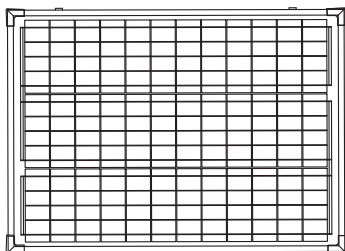

200W FOLDABLE SOLAR PANEL

ACCESSORIES INCLUDED:



3' (1m) cable
with SAE to
Anderson
connector



3' (1m) cable
with SAE to
DC 8055 male
connector



10' (3m) cable
with bare wire
to alligator
connector



20A/12V PWM
controller



Carry bag

Thank you for purchasing this FLEXSOLAR® product. Before operating, please read these instructions carefully. This instruction manual contains information for safe use and maintenance of the product.

Please keep this instruction manual in a safe place for future reference.

The manufacturer does not accept responsibility for any damages due to not following these instructions.

TABLE OF CONTENTS

General	Pg. 03
Safety Precautions for Using a Portable Solar Panel	
General Operation Notes	
Product Overview	Pg. 05
200W Solar Panel Briefcase	
Cables	
Solar Charger Controller	
Before Using	Pg. 12
What's in the Box	
Operation	Pg. 13
Installation	
Choose the location	
System Connection	
Maintenance	Pg. 15
Warranty Statement	Pg. 16

GENERAL

Please carefully read the following operation and safety instructions. Non-compliance with these instructions may void the product warranty.

This guide contains information regarding the operation and safe handling FLEXSOLAR® solar panels and components. All operations must be read and understood before attempting operation. If there are any questions, please contact your dealer or FLEXSOLAR® customer support for further information.

The user should conform to all safety precautions in the guide when using solar panels. Before using a solar photovoltaic system (including cable, power station or other electric equipment), the user should be familiar with the mechanical and electrical requirements for photovoltaic systems. Keep this guide in a safe place for future reference.

- All solar panels come with permanently attached output ports. Your dealer can provide additional extension cables to simplify module wiring.
- Exercise caution when wiring or handling solar panels exposed to sunlight.

- Photovoltaic solar panels convert light energy to direct-current electrical energy and are designed for outdoor use.
- Solar panels may be hung, placed flat, or use provided kickstand to face towards the sun.
- Do not frequently connect or disconnect wires attached to solar panels when they are exposed to sunlight in order to extend panel service life.
- Do not attempt to disassemble the solar panel, and do not remove any attached nameplates or components. Doing so will void the warranty.
- Do not apply paint or adhesive to the solar panel.
- Do not use mirrors or other hardware to artificially concentrate sunlight on the solar panel.

Safety Precautions for Using a Portable Solar Panel

- Solar panels produce electrical energy when exposed to sunlight.
- FLEXSOLAR® solar panels can be connected in series. When connected together (either in series or parallel), make sure that each solar panel has the same rated voltage. Your dealer can provide additional cables to simplify panel connections.
- Observe the instructions and safety precautions for all other components used in the system, including wiring, cables, connectors, and etc.
- Use only equipment, connectors, wiring, and mounting hardware suitable for use in a photovoltaic system.
- Always use the same type of solar panel in a particular photovoltaic system.
- Under normal operating conditions, solar panels will produce currents and voltages that may vary from those listed in the data sheet. Data sheet values are applicable at standard test conditions only.

General Operation Notes

- Do not stand or step on the solar panel.
- Do not drop the solar panel or allow objects to fall on the solar panel.
- Do not place any heavy objects on the solar panel.

PRODUCT OVERVIEW

200W Solar Panel Briefcase (FLC-G2-182000-P200-B)

FLEXSOLAR® solar panels are made of monocrystalline solar cells in series with high efficiency, high transmission rate, and anti-aging EVA. They are designed for easy use, extended longevity, and portable operation.

Unfolded View of the 200W Solar Panel Briefcase:

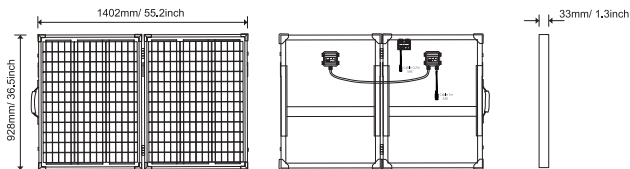

Folded View of the 200W Panel Briefcase:

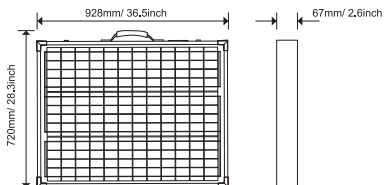

Specifications

Maximum Power (Pmax)	200W
Max Power Voltage (Vmp)	18.6V
Max Power Current (Imp)	10.8A
Open Circuit Voltage (Voc)	22.8V
Short Circuit Current (Isc)	11.2A
Maximum System Voltage (Vmax)	1000VDC
Cell Efficiency	21.5%
Cell Type	Monocrystalline
Power tolerance	± 5%
Temperature Co-efficient (Power)	-0.38%/ °C
Temperature Co-efficient (Voltage)	-0.30%/°C
Temperature Co-efficient (Current)	+0.05%/ °C
NOCT (Air 20°C, Sun 0.8kW/m ² , Wind 1m/s)	45±2°C
Net Weight	36.38lbs/(16.5kg)
Cable	15AWG(1.5mm ²), PVI-F, 3'(1000mm) Connector
Frame	Anodized Aluminum (Black)
Operation Temperature	40°F to 180°F (-40 C to 82 C)
IP Rating	IP65

Cables

- Passed conduction test, there was no short circuit, open circuit, dislocation, etc.
- Cables are free of dirt, scratches, damage, color difference or other defects.
- All materials meet RoHS environmental standards.

Specifications

Category	Location	Description	Total Length	Remark
Connection	One junction box to the other	Junction box Connection	2.95" (900mm)	Connected
Extension	From controller	Cable with SAE connector	0.66" (200mm)	Connected
	From junction box	Cable with SAE connector	3' (1000mm)	Connected
Accessories	/	Cable with SAE to Anderson connector	3' (1000mm)	In separate bag
		Cable with SAE to DC8055 connector	3' (1000mm)	
		Cable with bare wire to Alligator connector	10' (3000mm)	

Solar Charger Controller (PWM)

Safety Instructions

1. Make sure your battery has enough voltage for the PWM to recognize the battery type before first installation.
2. The battery cable should be as short as possible to minimize loss.
3. The PWM is suitable for lead acid batteries (Flood, AGM, GEL) and lithium ions, (please make sure the PWM is set for the right type of battery before usage). It is not suited for nickel metal hydride, or other types of batteries.
4. The PWM is only suitable for regulating solar modules. Never connect any other charging source to the PWM.
5. It is normal for the PWM to be hot when the PWM is at work. Please install the PWM on a flat and well-ventilated place.

20A Pulse Width Modulation (PWM) Controller

- Built-in industrial micro controller.
- Big lcd display, all adjustable parameter
- Full 3-stage PWM charge management.
- Built-in short-circuit protection, open-circuit protection, reverse protection, over-load protection.
- Dual MOSFET reverse current protection, low heat production.

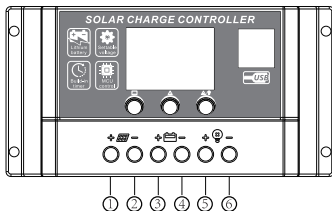

1	Positive solar input terminal	5	Positive load output terminal
2	Negative solar input terminal	6	Negative load output terminal
3	Positive battery output terminal		
4	Negative battery output terminal		

20A Pulse Width Modulation (PWM) Controller

Cable for solar panel connection	20AWG
Cable for battery connection	20AWG
Connector	N/A - customer to supply the connection to battery based on configuration
Dimension (W x H x D)	5.2*2.8*1.3 inch (133*70*34mm)
Net Weight	0.34lb/(154g)
Operation Temperature	-31°F to 149°F (-35°C to 65°C)

LCD Display/Key

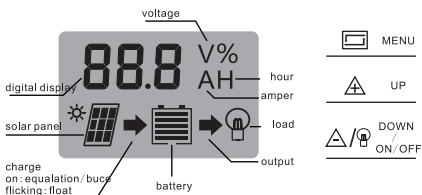

Menu: switch between different display, or to enter/exit setting by long press.

Up: press to increase value

Down: press to decrease value

Display Settings

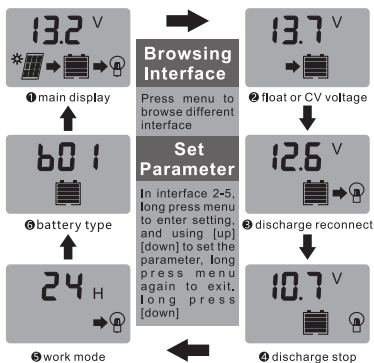

Attention:

1. Press the [down] button to on/off load manually at main display.

2. The work mode is working as below:

[24H] Load output 24 hours

[1-23H] Load on after sunset and closed after, setting hours

[0H] Dusk to dawn

Charging Parameters

MODEL	1210	1220	1230	
SYSTEM VOLTAGE	12V/24V AUTO			
Charge Current	10A	20A	30A	
Discharge Current	10A	20A	30A	
Max Solar Input	<50V			
Battery Type	b01Sealed	b02GEL	b03Flood	
Equalization	14.4V	14.2V	14.6V	
Float Charge	13.7V (default, adjustable)			
Discharge Stop	10.7V (default, adjustable)			
Discharge Reconnect	12.6V (default, adjustable)			
Battery Type	b04 Iron lithium 4 Strands	b05 Iron lithium 5 Strands	b06 lithium ion 3 Strands	b07 lithium ion 4 Strands
Constant Charging Voltage	3.6V*4/*5		4.2V*3/*4	
Recovery Charge Voltage	3.4V*4/*5		4.0V*3/*4	
Low Voltage Protection	2.6V*4/*5		3.1V*3/*4	
Low Voltage Recovery	2.9V*4/*5		3.7V*3/*4	
b04~b07 Parameters can't be set				
USB Output	5V/2A			
Self-consume	<10mA			
Operating Temperature	-35~+60°C			
Size/Weight	133*70*34mm/154g			

NOTE:

- 1). Charging parameters may vary based on availability of sunlight on the solar panels.
- 2). Product specifications are subject to change without notice.
- 3). Bold italic typeface voltage *2, *4 while using 24/48 system.

Troubleshooting

Situation	Probable	Solution
Charge icon not on when sunny	Solar panel opened or reversed	Reconnect
Load icon off	Mode setting wrong	Set again
	Battery low	Recharge
Load icon slow flashing	Over load	Reduce load watt
Load icon fast flashing	Short circuit protection	Auto reconnect
Power off	Battery too low/ Reverse	Check battery/Connection

BEFORE USING

What's in the Box

Make sure you have all the following items included in the package. If any item is damaged or missing, contact your dealer.

- 1 x 200W Solar Panel
- 1 x 3' (1m) cable with SAE to Anderson connector
- 1 x 3' (1m) cable with SAE to DC 8055 male connector
- 1 x 10' (3m) cable with bare wire to alligator connector
- 1 x PWM controller: 20A/12V
- 1 x Carry bag
- 1 x User Manual

OPERATION

Installation

1. Remove the product from the box.
2. Pull the tab upwards to open the locks.
3. Unfold and support the portable solar panel like the diagram below:
 - Lift and lay flat the portable solar panel;
 - Unfold the two sides of the panel;
 - Prop up the stands of the portable solar panel;
 - Stand the panels with locked legs on a flat surface
4. Adjust the face of the portable panel toward the sunlight

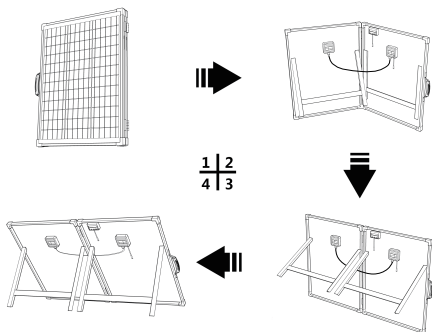

Choose the location

- Choose a flat location to place the solar panel.
- Place the solar panel in an open location. Make sure the panel can be exposed to the sun directly and avoid any shadow on the surface.
- Make sure the angle between panel and the sunlight is close to 90 degrees.

System Connection

There are two popular connections with solar system, including solar panel, power station, electronic equipment, and so on. For the power station as energy storage, the system connection as below

1. Charge Power Station

- Connect the portable solar panel to power station directly
- Connect the power station to the electronic equipment, like phone, iPad, laptop and so on.

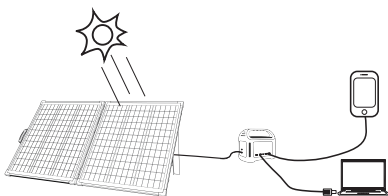

Note: The electronic equipment can also be charged directly using USB outputs from the PWM controller while there is no power station.

2. Charge battery through the PWM (Solar Charge Controller)

- Connect the cable from the battery to the PWM battery output terminals first.
- Wait until the PWM recognizes the battery type.
- Connect the cable from solar panel to the PWM solar input terminal.

NOTE: IT IS VERY IMPORTANT TO FOLLOW THE ABOVE-MENTIONED CONNECTION STEPS TO AVOID DAMAGING THE PWM CONTROLLER (SOLAR CHARGE CONTROLLER). ALWAYS CONNECT THE BATTERY TO THE PWM BATTERY TERMINALS BEFORE CONNECTING THE PWM TO THE SOLAR PANEL.

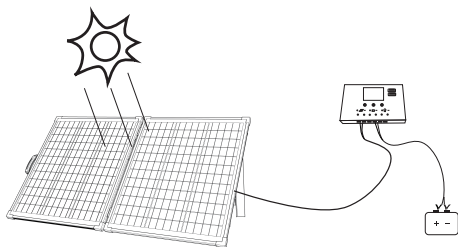
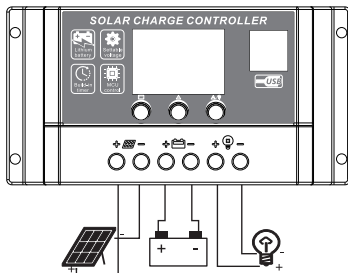

MAINTENANCE

- Clean the surface of the solar panel when needed. Always use a soft sponge or cloth for cleaning. A mild, non-abrasive cleaning detergent may be used to remove stubborn dirt. Don't clean when the panel surface is hot.
- Clean solar panels more frequently during drier months, as they may become covered in dust more quickly. A pressure washer is not recommended.
- Caution: Observe the maintenance instructions for all components used in the system, such as support frames, charge controller, batteries, etc.

WARRANTY STATEMENT

FLEXSOLAR® warrants to the original consumer purchaser that the FLEXSOLAR® product will be free from defects in workmanship and material under normal consumer use during the applicable warranty period identified in the 'Warranty Period' section below, subject to the exclusions set forth below. This warranty statement sets forth FLEXSOLAR® total and exclusive warranty obligation. We will not assume, nor authorize any person to assume for us, any other liability in connection with the sale of our products.

Warranty Period:

The warranty period is 24 months. In each case, the warranty period is measured starting on the date of purchase by the original consumer purchaser. The sales receipt from the first consumer purchase, or other reasonable documentary proof, is required in order to establish the start date of the warranty period.

Remedy:

FLEXSOLAR® will repair or replace (at FLEXSOLAR® option) any FLEXSOLAR® product that fails to operate during the applicable warranty period due to defect in workmanship or material. If a valid claim is made during the applicable period, FLEXSOLAR®, at its option, will either (1) replace the product, or (2) exchange the product with a product that is of equal value. A replacement product assumes the remaining warranty of the original product or 60 days from the date of replacement, whichever is greater. Customer is responsible for the return shipping costs.

Limited to Original Consumer Buyer:

The warranty on FLEXSOLAR® products is limited to the original consumer purchaser.

Exclusions:

FLEXSOLAR® warranty does not apply to (I) any product that is misused, abused, modified, damaged by accident, or used for anything other than normal consumer use as authorized in FLEXSOLAR® current product literature, or (II) any product purchased through an online auction house.

How to Receive Service:

To obtain warranty service, you must contact our customer service team. If our customer service team determines that further assistance is required, they will give you a Return Material Authorization (“RMA”) number and will provide you with return instructions. You must properly package the product, clearly marking the RMA number on the package and including proof of your purchase date with the product. We will process your return and send your repaired or replacement product to you in continental North America.

Exclusive Remedy; Limitation of Liability:

The foregoing provisions state FLEXSOLAR® entire liability, and your exclusive remedy, for any breach of warranty, express or implied.

IN NO EVENT WILL FLEXSOLAR® BE LIABLE FOR ANY CONSEQUENTIAL OR INCIDENTAL DAMAGES ARISING FROM ANY USE OR MALFUNCTION OF ANY FLEXSOLAR PRODUCT, OR FROM ANY BREACH OF WARRANTY, INCLUDING DAMAGE TO OTHER DEVICES. IN NO EVENT WILL FLEXSOLAR'S LIABILITY FOR ANY CLAIM, WHETHER IN CONTRACT, WARRANTY, TORT (INCLUDING NEGLIGENCE AND STRICT LIABILITY) OR UNDER ANY OTHER THEORY OF LIABILITY, EXCEED THE AMOUNT PAID BY YOU FOR THE FLEXSOLAR® PRODUCT.

Some states or provinces do not allow the exclusion or limitation of incidental or consequential damages, so the above limitation or exclusion may not apply to you.

Product Label:



UPC code:



Model Type	FLC-G2-1820000-P200-B
Max Peak Power (Pmax [W])	200W
Maximum Power Point Voltage (Vmp [V])	18.6V
Maximum Power Point Current (Imp [A])	10.8A
Open Circuit Voltage (Voc [V])	22.8V
Short Circuit Current (Isc [A])	11.2A
Maximum System Voltage (Vmax)	1000VDC
Normal Operating Cell Temperature (NOCT)	45±2 °C
Temperature Range (°C)	-40 °C → +82 °C
Power Tolerance	±5%
Application Class	Class A
Gross Weight kg/(lbs)	20.4kg/(45 lbs)
Net Weight kg/(lbs)	16.5kg/(36.38 lbs)
Dimensions (unfolded) mm/in	1402x928x33 mm/55.2x36.5x1.3 in
Dimensions (folded) mm/in	928x720x67 mm/36.5x28.3x2.6 in

▲ technical data at Standard Test Condition (STC)
Standard Test Condition (E=1000W/m², T=25 °C, AM 1.5)

Serial Number:



Only qualified personnel should install or perform maintenance work on these modules.
This unit produces electricity if exposed to light.
Follow all applicable electrical safety precautions.
Don't disconnect when loading.
Don't damage or scratch the surface of the module.



INNOTECH ENTERPRISE LLC

Customer Support:
800-620-1249
support@flexsolarenergy.com
flexsolarenergy.com

Innotech Enterprise LLC is a wholly subsidiary of Flextech Company.

FLEXSOLAR® is a registered trademark of Flextech Company.

®All rights reserved.

©2013-2024 FLEXSOLAR® is a trademark licensed for use by Flextech Company and registered in the U.S.



M-FLC-G2-182000-P200-B