



AQUA MARINA



INFLATABLE SPORT BOATS

User's Guide

BT-88810 / BT-88830 / BT-88850 /
BT-88850AL / BT-06300WD / BT-06300AL
BT-06330WD / BT-06330AL / BT-06360WD / BT-06360AL



www.aquamarina.com

THANK YOU FOR CHOOSING AQUA MARINA DELUXE SPORT BOATS



Compact and lightweight, these economical inflatable boats are great ship to shore tender crafts or a highly portable pleasure boat for the boater on the go. Bring your roll-up boat with you to the lake, the beach or wherever! With a set-up time of just minutes, no trailers and no special equipment, these boats will allow easy access to some of those places you've only seen from the shore. Various floor decks can be chosen at your disposal.

This manual has been compiled to help you achieve long term safe use and pleasure from your Aqua Marina® boats.

GENERAL INFORMATION

SAFETY

In a manual of this type it is impossible to give adequate space to the topic of water safety. Check in your local area for information and/or training as needed. Inform yourself about local regulations and dangers related to boating and/or other water activities. It is your responsibility to be aware of and comply with all relevant safety regulations. For all water recreation or sport you should have a reasonable swimming ability. Just as swimmers have a cardinal rule about not swimming alone. It is strongly advised that you should never go boating alone.

PLEASE KEEP THIS MANUAL IN A SECURE PLACE, AND HAND IT OVER TO THE NEW OWNER WHEN YOU SELL THE CRAFT. RECORD THE "HULL IDENTIFICATION NUMBER" (HIN) WHICH IS LABELLED ON THE BOAT

S/N.....

MANUFACTURER'S CERTIFICATION

Our boats comply with the ISO 6185 standard established by the International Organization for Standardization.

MANUFACTURER'S RECOMMENDATION

The total number of persons, motor power and total weight shall not exceed the limits labeled (Fig. 1) on the boat.

1	 <small>AQUA MARINA</small> STANDARD EN ISO 6185-2:2018 STANDARD BS EN ISO 6185-2:2018 DESIGN CATEGORY C BOAT TYPE TYPE V	
2	BOAT MODEL BT-06360WD	
3	= 5	= 1
4	+ + = 540 kg (1190 lbs)	
5	= 14.7 kw	20 HP
6	= 0.25 bar (3.62 psi)	
7	S/N CN-ORP DATE _____ N.W 59 kg (129.8 lbs)	
ORIENTAL RECREATIONAL PRODUCTS (SHANGHAI) CO., LTD. NO. 1699 Da Ye Road, Fengxian, Shanghai, China WWW.AQUAMARINA.COM MADE IN CHINA		

Fig.1

Label format for boat

1. As per Directive 2013/53/EU & Recreational Craft Regulations 2017 boat design category Design Category C - Inshore:
Designed for voyages in coastal waters, large bays, estuaries, lakes and rivers where conditions up to, and including, wind force 6 and significant wave heights up to, and including, 2m may be experienced.
2. Maximum person's capacity without console
3. Manufacturer's recommended maximum load capacity
4. Maximum motor power
5. Manufacturer's recommended working pressure
6. Hull identification number (HIN)
7. Net weight

SAFETY CHECK LIST & SAFETY WARNING

- Always wear an approved Personal Flotation Device (Life Preserver).
- Be aware of your local boating rules and regulations and abide by them accordingly.
- Check inflation levels each time before you go out and inflate your boat for a full 24 hours before undertaking long trips.
- DO NOT allow children to use Aqua Marina unsupervised.
- DO NOT consume alcohol while boating or operating a boat while under the influence of alcohol or drugs.
- DO NOT drag your Aqua Marina over rocks or gravel if it can be avoided.
- DO NOT exceed the certified maximum capacities of this boat under any circumstance.
- DO NOT go boating alone.
- DO NOT use compressors, co² or compressed air for inflation, only use Aqua Marina recommended pumps.
- DO NOT use your Aqua Marina Boat as a personal flotation device as they are designed for leisure/recreation in mind.
- DO NOT sleep inside of your Aqua Marina while on the water.

INFLATABLE BOAT SPECS & FEATURES

SPECIFICATIONS

Model	Category	Item size	Air pressure	No. of air chamber	Max. passenger	Max. payload	Max. motor power	Net weight
BT-88810	C	8'2"×4'3" (2.5×1.29m)	0.16bar hull	3	2+1	240kg (529lbs)	4HP/3KW	25kg (55.1lbs)
BT-88830	C	8'2"×4'3" (2.5×1.29m)	0.16bar hull 0.04bar floor	3+1	2+1	240kg (529lbs)	4HP/3KW	21kg (46.3lbs)
BT-88850	C	9'1"× 4'11" (2.77×1.50m)	0.16bar hull	3+keel	3+1	320kg (705lbs)	9.9HP/ 7.5KW	33.5kg (73.9lbs)
BT-88850AL	C	9'1"× 4'11" (2.77×1.50m)	0.16bar hull	3+keel	3+1	320kg (705lbs)	9.9HP/ 7.5KW	35kg (77lbs)

Model	Category	Item size	Air pressure	No. of air chamber	Max. passenger	Max. payload	Max. motor power	Net weight
BT-06300WD	C	9'9" x 5' (2.96x1.53m)	0.16bar hull	3+keel	4	360kg (794lbs)	9.9HP/ 7.5KW	39kg (85.8lbs)
BT-06300AL	C	9'9" x 5' (2.96x1.53m)	0.16bar hull	3+keel	4	360kg (794lbs)	9.9HP/ 7.5KW	41kg (90.4lbs)
BT-06330WD	C	11' x 5' (3.30x1.53m)	0.25 bar hull	3+keel	5	480kg (1058lbs)	15HP/ 11KW	43kg (94.6lbs)
BT-06330AL	C	11' x 5' (3.30x1.53m)	0.25 bar hull	3+keel	5	480kg (1058lbs)	15HP/ 11KW	42kg (92.4lbs)
BT-06360WD	C	12' x 5'9" (3.59x1.76m)	0.25 bar hull	3+keel	5+1	540kg (1190lbs)	20HP/ 14.7KW	59kg (129.8lbs)
BT-06360AL	C	12' x 5'9" (3.59x1.76m)	0.25 bar hull	3+keel	5+1	540kg (1190lbs)	20HP/ 14.7KW	57kg (125.4lbs)

STANDARD EQUIPMENT

Model	Wooden bench seat	Hand pump with Pressure gauge	Repair kit	Carry bag	Aluminum oar
BT-88810 BT-88830 BT-88850 BT-88850AL BT-06300WD BT-06300AL BT-06330WD BT-06330AL	1pc	16" hand pump	1pc repair patch	1pc	1pair
BT-06360WD BT-06360AL		18" hand pump			

DESCRIPTION

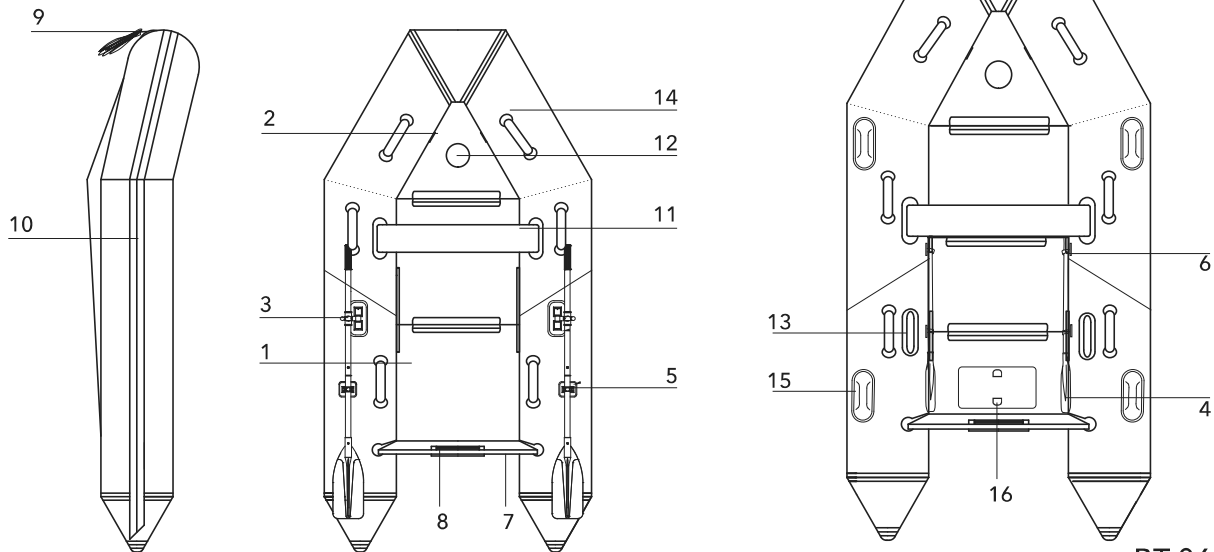

BT-06360

NOTE: Drawings and pictures for illustration purpose only. Actual product may vary.
Not to scale.

1	Boat deck	2	Recessed pressure valve
3	Oar holder	4	Aluminum oar
5	Rotation oarlock (except BT-06360AL/WD)	6	Velcro for oar (only BT-06360AL/WD)
7	Transom (Height15"/38.1cm)	8	Engine mount
9	D-ring & towing rope	10	Rubbing strake
11	Wooden bench seat	12	Inflatable keel (except BT-88810/30)
13	Seat connector (1 pair for BT-88810, BT-88830, BT-88850, BT-88850AL, BT-06300WD/AL, 2 pairs for BT-06330WD/AL, BT-06360WD/AL)	14	Safety grab handle (2 pairs for BT-88810, BT-88830, 3 pairs for BT-88850, BT-88850AL, BT-06300WD/AL, BT-06330WD/AL, BT-06360WD/AL)
15	PVC lift handle (1 pair for BT-06300WD/AL, BT-06330WD/AL, 2 pairs for BT-06360WD/AL)	16	Tank fixing band (For BT-88850AL, BT-06300AL, BT-06330AL, BT-06360WD/AL)

BOAT DECK:

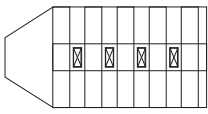
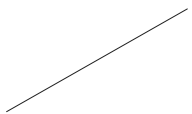
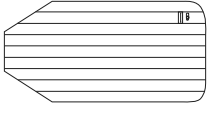
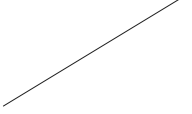
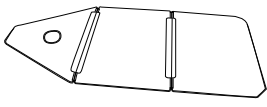
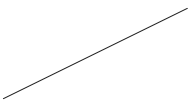
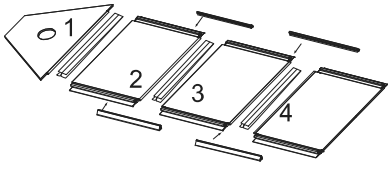
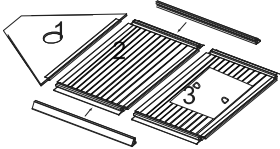
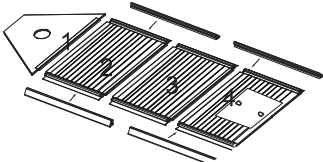
Deck type	Images	Models	No. of decks	No. of stringers
Slat wood deck		BT-88810	5 pcs	
Inflatable deck		BT-88830		
Wood deck		BT-88850	1 pc	
		BT-06300WD BT-06330WD BT-06360WD	4 pcs	4pcs (A type for both sides) 3pcs ("I" shape among decks)
Aluminum deck		BT-88850AL	3 pcs	2pcs (A type for both sides)
		BT-06300AL BT-06330AL BT-06360AL	4 pcs	4pcs (A type for both sides)

SET UP INSTRUCTION

UNFOLD THE BOAT

Choose a smooth and clean surface to spread the boat out so that the inflatable chambers can be filled easily.



SLAT WOOD INSTALLATION (for BT-88810)

Clear a flat area (make sure it is clean and free of sharp objects). Remove the hull from box and take off the plastic bag. BT-88810 is the easiest tender to set-up, it has slat floorboards ready to be assembled, so just unroll the hull and lay it out. Insert the five slat wood deck boards with proper order into boat floor.

ALUMINUM FLOOR INSTALLATION

1. BT-88850AL

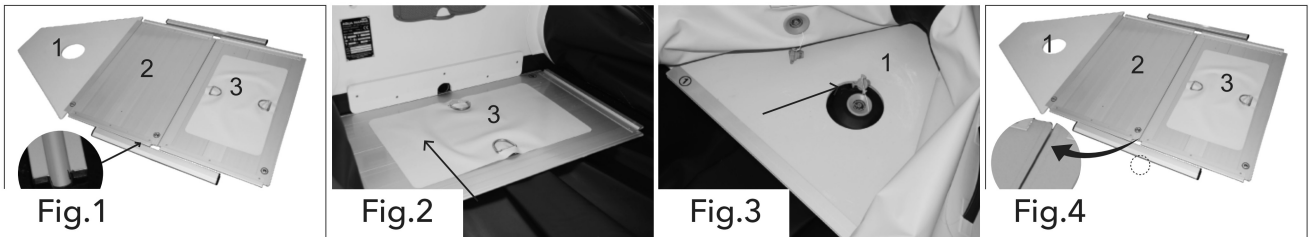

- 1.1 Start the assembly from deck board installation. Insert the Board #1 into the bow and push it forward until the Air Valve of the inflatable Keel is aligned with the hole on the board. Lift the sides of the boat as necessary in order to slide the Board #1 into place. (Fig. 3)
- 1.2 Insert the Board #3 into the stern and push the board under the transom. (Fig. 2)
- 1.3 Align the slot on the Board #1 with the protrusion of Board #2 and push the two pieces together. (Fig. 4)
- 1.4 Lift up Board #2, align the protrusion of Board #2 with the slot on the Board #3 and push the two boards down making them flush. (Fig. 4)
- 1.5 Attach the two side stringers to keep the floorboards securely in place. (Fig. 1)

2. BT-06300AL/BT-06330AL/BT-06360AL

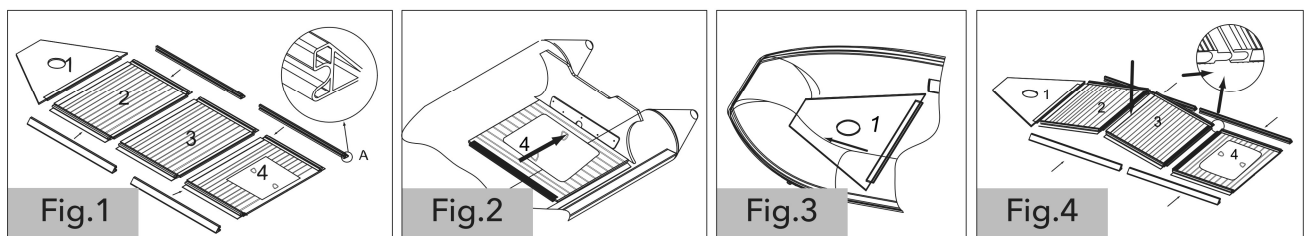

- 2.1 Start the assembly from deck board installation. Insert the Board #1 into the bow and push it forward until the Air Valve of the inflatable Keel is aligned with the hole on the board. (Fig. 1)
- 2.2 Insert the Board #4 into the stern and push the board under the transom. (Fig. 2)

- 2.3 Align the protrusion of Board #1 with the slot on the Board #2 and push the two pieces together. (Fig. 4)
- 2.4 Align the protrusion of Board #3 with the slot on the Board #4 and push the two pieces together. (Fig. 4)
- 2.5 Lifting up Board #2 and #3, align the protrusion of Board #2 with the slot on the Board #3 and push the two boards down making them flush. (Fig. 4)
- 2.6 Place the two curved and straight stringers to keep the floorboards securely in place. (Fig. 1)

NOTE:

- The floorboards must be assembled before inflating the boat.
- Identifying numbers on the floorboards must be faced upwards.
- After the assembly, carefully check the floorboards are secured and tight. If the floorboards are not tight or smooth, re-do the assembly.

Tip: It's better to inflate the boat about 20% before Aluminum floor installation.

a. Insert front bow section of the floor.(Fig.1)

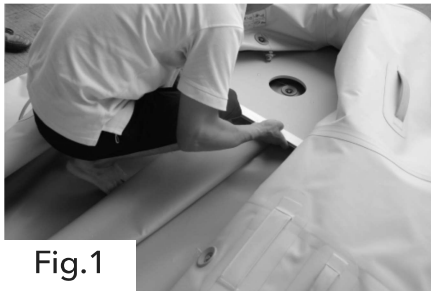

Fig.1

b. Insert second and last sections of the floor.(Fig.2)



Fig.2



c. Lift the middle section a bit and create a roof-like structure.(Fig.3)

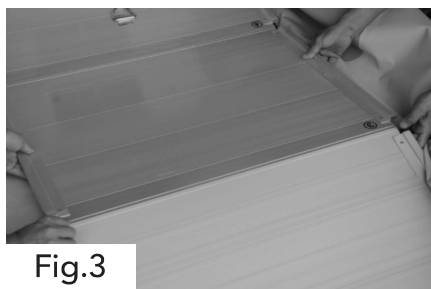

Fig.3

d. Step on raised part of two connected floor sections and make sure that floor will flatten by spreading inside the boat (Fig.4). Connect the side stringers. (Fig.5)



Fig.4



Fig.5

e. Inflate the left and right tube of the boat firstly and then inflate bow section of the boat. Finally, inflate the keel. Use hand pump to finish.

WOOD DECK INSTALLATION

1. BT-88850

BT-88850 is equipped with a foldable floorboard system. (Fig. 1)

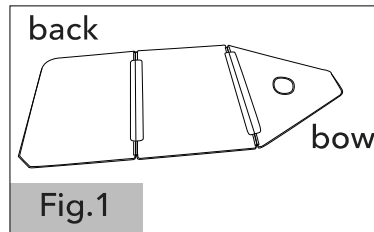

Fig.1

Tip: It's better to inflate the boat about 20% before plywood deck installation.

a. Start by fitting the wooden bow board between the air tubes and bottoms. Push it forward as far as possible until it reaches the top of the bow (Fig. 2) and the air valve of the inflatable floor fits into the hole of the stern wooden board. Fit the back board to the rear end. (Fig. 3)



Fig.2

b. Lift the middle section a bit and create a roof-like structure. (Fig.3)

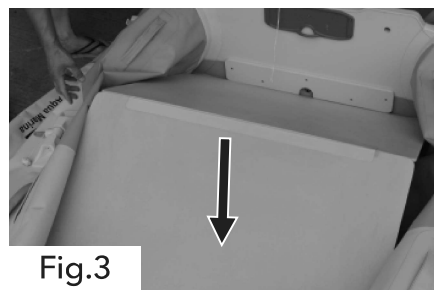

Fig.3

c. Step on raised part of two connected floor sections and push down the two boards at the joint. Make sure the deck is flattened by spreading inside the boat (Fig. 4).



Fig.4

d. Inflate left and right tube of the boat firstly and then inflate bow section of the boat. Finally, inflate the keel. Use hand pump to finish.

2. BT-06300WD/BT-06330WD/BT-06360WD

2.1 Start the assembly from deck board installation. Insert the Board #1 into the bow and push it forward until the Air Valve of the inflatable Keel is aligned with the hole on the board. (Fig. 1)

2.2 Insert the Board #4 into the stern and push the board under the transom. (Fig. 2)

2.3 Connect the Board #1 with Board #2 by inserting the "I" shape stringer. (Fig. 3)

2.4 Connect the Board #3 with Board #4 by inserting the "I" shape stringer. (Fig. 4)

2.5 Connect the Board #2 with Board #3 by inserting the "I" shape stringer. (Fig. 4)

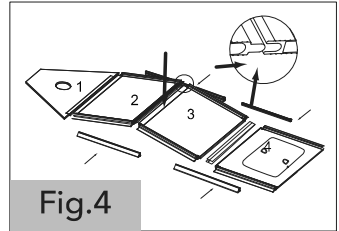
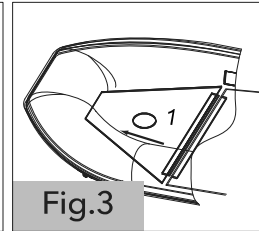
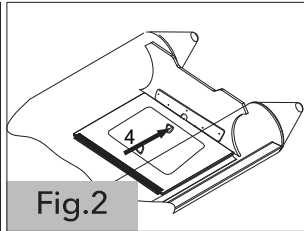
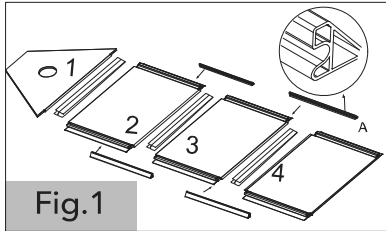

Tip: It's better to inflate the boat about 20% before wooden floor installation.

a. Insert front bow section of the floor. (Fig.1)



b. Insert second and last sections of the floor. (Fig.2)



c. Lift the middle section a bit and create a roof-like structure. (Fig.3)



d. Step on raised part of two connected floor sections and make sure that floor will flatten by spreading inside the boat. (Fig.4)



e. Connect the side stringers. (Fig.5)



f. Inflate left and right tube of the boat firstly and then inflate bow section of the boat. Finally, inflate the keel. Use hand pump to finish. (Fig.6)



VALVE OPERATION

Follow the instructions below for valve operation and correct inflation and deflation procedures. (This kind of valve is used for the boat hull and keel.)

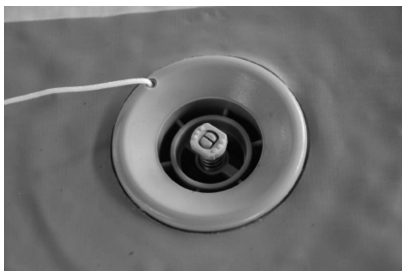

To close off the valve for inflation, make sure that the center valve pin is in the "UP" position. If it is in the "DOWN" position, press down on the valve pin and turn it counterclockwise until it pops up.

VALVE DIAGRAM

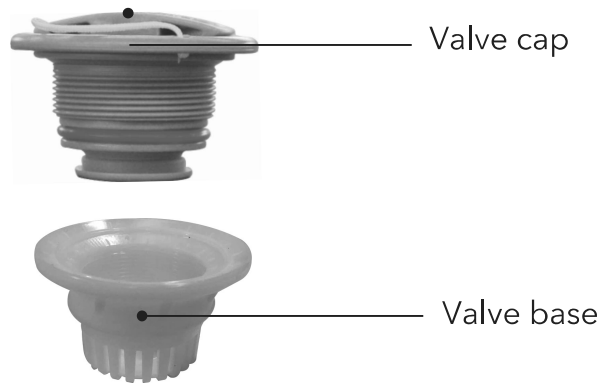

To open the valve for deflation, press down on the valve pin and turn it clockwise so it locks down.

Be careful of any sand or debris around the valve area when deflating as small particles could become airborne with the release of the air pressure.

Always lock the valve cover over the valve stem when in use. This will prevent accidental air release and entrance of any particles into the air chambers.

INFLATION STEPS

1. Ensure the air valve's center pin is properly in position by rotating the control stem until it pops out. This ensures no air escapes during inflation.
2. Inflate the hull. The ideal pressure is 0.16bar - 0.25bar. (Fig. 1)
3. Inflate the keel. (BT-88810, BT-88830 excluded)
Stop inflating until the pressure reaches 0.3bar. (Fig. 2)
4. Inflate the floor. (only BT-88830)

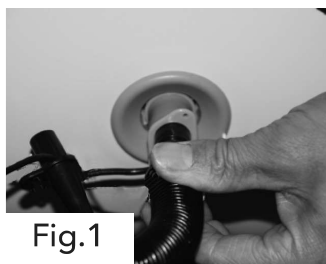

Fig.1

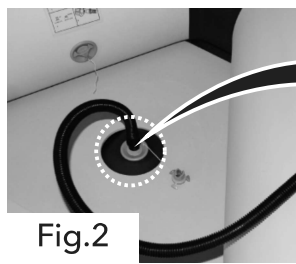
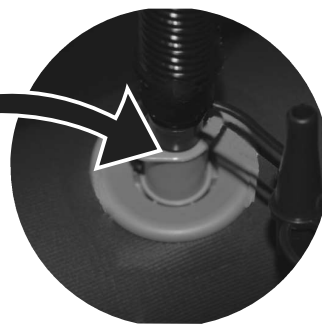

Fig.2



Inflation valve operation for BT-88830

1. Open the external cap and pull firmly to make it pushed out. (Fig.1)
2. Attach a suitable adapter nozzle to the inflation end of the pump. Insert the pump and start pumping. (Fig.2)
3. When the boat is fully inflated, gently twist the adapter sleeve to right while backing pump out of the valve. (Fig.3)
4. Fully remove the adapter and close the external stopper. (Fig.4)

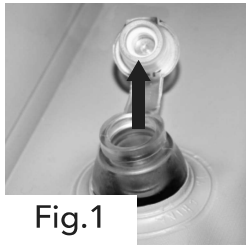

Fig.1

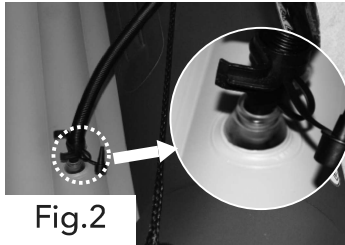

Fig.2

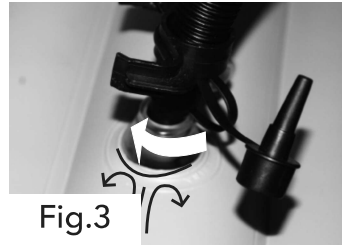

Fig.3

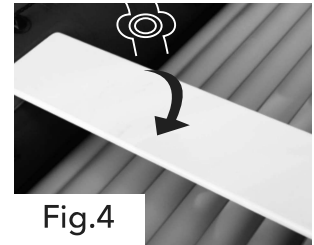
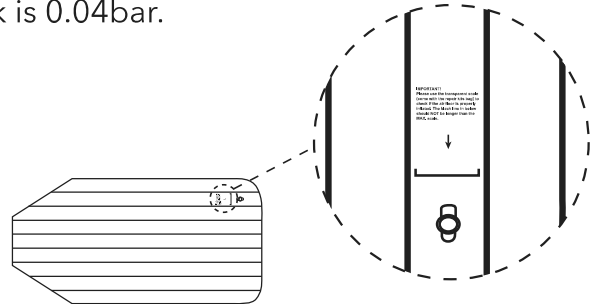

Fig.4

After inflation, make sure the pressure of boat deck is 0.04bar.

IMPORTANT!

For BT-88830, please use the transparent scale (come with the repair kits bag) to check if the inflatable floor is properly inflated. The black line should NOT be longer than the MAX. scale.



NOTES: Check the pressure every time before usage. Air temperature and weather conditions do affect the internal air pressure of inflatable products. In cold weather the product will lose some pressure due to the fact that the air will contract. If this occurs, you may want to add a little air to the product. However, in hot weather, the air will expand. You must let some air out to prevent the product from failing due to overpressure.

- Only use Aqua Marina® approved inflation pumps.
- Never use motor-driven high-pressure air pumps as this may result in over-inflation. Fill with cold air only.
- Under and over-inflation will result in safety hazards.
- Always check the inflation pressure before using the boat.
- Never stand on or rest objects on the boat during inflation.
- Never open the cap of air valve while the boat is in use.
- Be sure the valve is tightly closed before using the boat.

ACCESSORY ASSEMBLY

1. Wooden bench seat installation

Slide the bench seat into the position by inserting the flaps on both chamber of the boat into notches on the Seat Board.

2. Insert the plug into the drain valve on the transom

Always make sure the plug is secured into the valve before launching the boat and do not open while afloat.

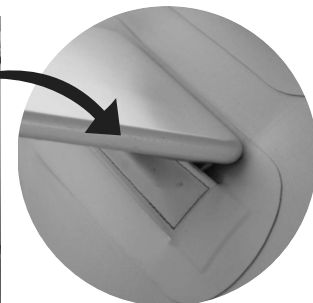
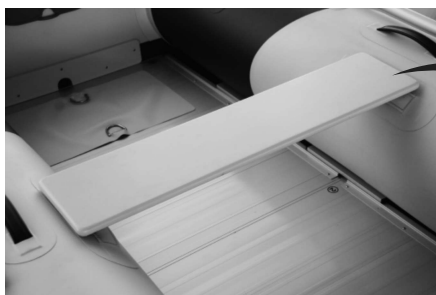

OUTBOARD MOTOR INSTALLATION

After the boat is fully inflated and well assembled, attach your outboard motor onto the Engine Mount at the center of the transom.

NOTE:

- Ensure the motor is always fixed on the transom.
- Read the instruction manual of the outboard motor for correct installation and operation.

WARNING: Overpowering a boat can result in serious injury, death or boat damage. Find the maximum motor power marked on the boat label.

OAR ASSEMBLY

1. Join the two shafts of the oars by snapping them together. (Fig. 9)
2. There are pre-drilled holes in the middle of the oars so you can slide it over the oar holder and then secure the oar in place by using the rotation oarlock. (Fig. 10 & 11)

NOTE: When the oars are not in use, leave the oars in the oar holders to avoid damage and loss.

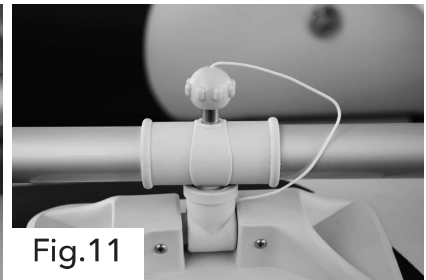
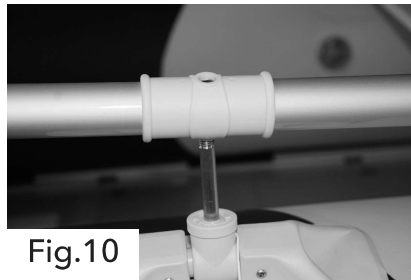
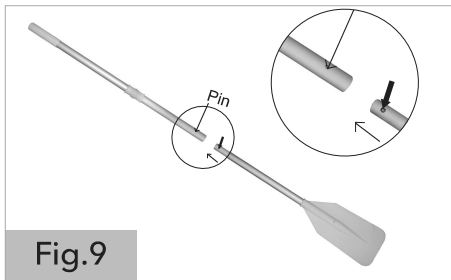

PRODUCT CARE AND STORAGE

The boat is made of the highest quality materials and complies with ISO 6185 standards. Altering the construction of the boat will endanger your own safety, safety of the occupants and void the limited warranty!

There is very little that you have to do to keep your boat in good condition for many years.

- When landing on the shore, carry the boat. Do not tow it on the sand or ground as damage may occur.
- If you use the tow rings to tow the boat, go slowly to avoid over-towing as damage may occur.
- Clean your boat after a trip to prevent damage from sand, salt water or sun exposure. Most dirt can be removed with a garden hose, a sponge and mild soap. Make sure the boat is completely dry before storing. Use as few cleaning agents as possible, do not discharge waste agents into water, and clean your boat preferably on land.

- Be sure your product is completely dry before storing.
- The products may be stored inflated, but do not place any heavy or sharp objects on it. Hanging the boat is not recommended.
- Open all air valves including the keel's and deflate boat completely. Remove all the accessories from the boat; floor boards, seats and oars.
- Fold the boat from back to front to remove additional air. The boat storage bag is designed to allow you to get your boat into the bag as easily as possible with minimal folds. Follow the diagram below for the best folding procedures:



- Storage is best in a dry room. Ensure protection against rodents and other vermin, as they feed on the fabric of the boat.
- Store the product and accessories in a dry, temperature controlled, between 32 degrees Fahrenheit (0 degrees Celsius) and 104 degrees Fahrenheit (40 degrees Celsius) storage location.

LEAK DETECTION AND REPAIR

AIR LEAK DETECTION

If your boat appears a bit soft, it might not be because of a leak. If the boat was inflated late in the day with 32°C (90°F) air, that air might cool down to 25°C (77°F) overnight. The cooler air exerts less pressure on the hull, so it could appear soft the next morning. If there has been no temperature variation, you need to start looking for a leak:

- Take a good look at your boat from just a few feet away. Flip it over and closely check over the outside. Any large leaks should be clearly visible.
- If you have an idea where your leak is, use a mix of dishwashing liquid and water in a spray bottle, and spray over the suspicious areas. Any leak will produce bubbles that will pinpoint the location of the leak.
- Check valves for leak, if necessary, spray soapy water around the valve and the valve base.

SMALL REPAIRS

Inadvertent punctures can be repaired using included vinyl repair patch and vinyl glue. You can also purchase additional PVC or silicon based glue for repairing camping mats, tents or shoes from your local market to patch your boat. Please refer to the instruction of the glue for patching.

1. Thoroughly clean and dry the damaged area. Completely deflate the product.
2. Cut a portion of the patch to cover the puncture and allow an additional 1/4" on all sides. Always cut a round patch, never leave square corners.
3. Be sure the repair area is completely dry.
4. Apply generous coat glue to the vinyl repair patch and to the product.
5. Allow the glue to dry for 2 to 3 minutes, or until the glue becomes tacky.
6. Apply the patch to the product, using your thumb or finger; apply even pressure across the entire surface of the patch. Make sure the edges of the patch are pressed down along the entire diameter.
7. Allow the product to dry for at least 12 hours before inflating and using

If there are large tears/cracks, please bring the water craft or any essential equipment part into a professional repair shop for appropriate repair or replacement.

WARRANTY

AM warrants this product to be free from major defects in material or workmanship to the original purchaser for a period of ONE (1) Year from the date of purchase. This warranty is subject to the following limitations:

1. The warranty is valid only when this product is used for normal recreational activities and does not cover products used in rental or school operations.
2. AM will make the final warranty determination, which may require inspection and/or photos of the equipment, which clearly show the defect(s). If necessary, this information must be sent to the AM distributor in your country with prepaid postage. Product can be returned only if a return authorization number is given in advance by the AM distributor. The return authorization number must be clearly labeled on the outside of the package, or it will be refused.
3. If a product is deemed to have manufacturing defect, the warranty covers the repair or replacement of the defective product only. AM will not be responsible for any costs, losses, or damages incurred as a result of loss or use of this product.
4. This warranty does not cover damage caused by misuse, abuse, neglect, normal wear and tear including, but not limited to, punctures, damage due to excessive heat exposure, damage caused by improper handling and storage, damage caused by use in waves or shore break, board breakage caused by filling or crashing in surf conditions, or damage caused by anything other than defects in material and workmanship.
5. This product must not be modified and/or fitted with a motor.
6. This product must not be used in excess of the manufacturers recommended maximum load capacity.
7. This warranty is void if any unauthorized repair, change or modification has been made to any part of the equipment.
8. The warranty for any repaired or replacement equipment is good from the date of the original purchase only.
9. The original purchase receipt must accompany all warranty claims. The name of the retailer and date of purchase must be clear and legible.
10. There are no warranties that extend beyond the warranty specified here in.



This product is designed in accordance with standards for a specific use. Any modifications or transformations higher than that indicated by the manufacturer could result in serious risks for the user and will void the warranty.

© **Oriental Recreational Products (Shanghai) Co., Ltd**

®™Trademarks used in some countries of the world under license to / ®™marques utilisées sous licence de /
Marcas registradas utilizadas en algunos países del mundo bajo licencia de / Das®™ Warenzeichen wird in
einigen Ländern der Welt unter der Lizenz davon benützt / Oriental Recreational Products (Shanghai) Co., Ltd.,
No.1699, Daye Road, Shanghai, China 201402 • Represented in the European Union by / Représenté dans l'Union
européenne par / Innerhalb der Europäischen Union vertreten durch / Representado en la Unión Europea por /
ORPC S.A.S. 17 avenue George V 75008 Paris - France • Represented in the UK by / Représenté au Royaume-Uni
par / Innerhalb des Vereinigten Königreichs vertreten durch / Representado en Reino Unido por / Marine &
Outdoor Ltd. Birch Farm, Brooks Road, Raunds, Wellingborough NN9 6NT, UK