

Duro Max
NEXT GENERATION POWER SYSTEMS

XP13000X

U S E R M A N U A L



This manual provides information regarding the operation and maintenance of these products. We have made every effort to ensure the accuracy of the information in this manual. We reserve the right to change this product at any time without prior notice.

5800 Ontario Mills Pkwy
Ontario, CA 91764 USA
www.duromaxpower.com

Call our Customer Care Team Toll Free 8-5 pm PST Mon-Fri

844-DUROMAX



CONTENTS

1.	Introduction	
	Introduction	6
	General Safety Procedures	8
	Carbon Monoxide Safety	12
	Unit and Purchase Information	14
2.	Generator Components	
	Generator Components	16
	Package Contents	18
3.	Generator Setup	
	Remove Shipping Braces	21
	Wheel Kit Installation.....	22
	Connect the Battery	24
	Adding Oil	25
	Adding Gasoline	26
	Grounding the Generator	27
	High Altitude Operation	27
4.	Starting the Generator	
	Checking the Oil	30
	Check the Gas Level	31
	Starting the Generator	32
	Starting the Generator Using Recoil Start	34
5.	Using the Generator	
	AC Usage	38
	Connecting the Generator to a Home.....	41
	Connecting a Load to the Generator.....	42
	Choosing the Right Power Cord	43
	Using the Digital Multimeter	44
	Idle Control Usage	45

6.	Maintenance and Care	
	Maintenance Schedule.....	48
	Break-In Period	49
	Maintenance Log	49
	Checking the Oil	50
	Changing the Oil.....	51
	Cleaning the Air Filter	52
	Spark Plug Maintenance	54
	Emptying the Gas Tank	56
	Cleaning the Fuel Filter Cup.....	58
	Transporting the Generator	59
	Storing the Generator for Same Day Use	60
	Storing the Generator for Use Within 30 Days.....	61
	Storing the Generator for Longer than 30 Days	62
	Specifications.....	64
7.	Troubleshooting	
	Basic Troubleshooting	66
	Changing / Inspecting the Carbon Brushes	67
	Changing / Inspecting the AVR	69
	Wiring Diagram	72
8.	Warranty	74
9.	Contact Information	78

For more information and resources on this model scan the QR code below to link to our website product information page.





POWERING EVERYONE...
ANYWHERE!



THE DUROMAX WAY

The DuroMax Way is more than just a brand, it is our understanding and appreciation of just how important power can be to someone without it...



DUROMAX FOR HOME

Electricity in our home not only provides comfort but safety as well. From keeping the heat or A/C on to keeping our food cold, power is essential to our daily lives. Inevitably when disaster strikes and we are left without power for a prolonged period of time, our way of life is put at risk. This is by far the most critical time for reliable portable power.



DUROMAX FOR WORK

On the job site, portable power allows you the ability to get work done in remote locations when traditional power sources are usually unavailable. Equipment like table saws, sanders, and work lights are a necessity and portable power can play a critical role in getting a job done successfully and efficiently.



DUROMAX FOR PLAY

Camping outdoors in a remote location can get one in touch with nature and allow them to forget the stress of the day to day grind. Here portable power can provide comfort as well as safety. With portable power, you can keep your cell phone charged, light up your campsite, or even brew a cup of coffee, all while being miles from civilization.

The DuroMax Way is a commitment to excellence. This vision is focused on the quality, reliability, and durability of our products combined with outstanding customer service. We understand that having dependable power whenever and wherever you need it provides comfort, safety, and peace of mind. It is through this philosophy that DuroMax achieves our vision of...

POWERING EVERYONE... ANYWHERE!

INTRODUCTION

DuroMax Power Equipment is headquartered in Ontario, California and is the industry's leader in Dual Fuel portable generator technology. In addition to a full assortment of portable generators ranging from digital inverters to large 15,000-watt portable standby units, our product line includes pressure washers, engines, pumps, and accessories.

The foundation of our company is built on quality, reliability, durability, and customer service. At DuroMax our vision is simple, we are committed to Powering Everyone... Anywhere!



Notice Regarding Emissions

Engines that are certified to comply with U.S. EPA emission regulations for SORE (Small Off-Road Equipment), are certified to operate on regular unleaded gasoline and may include the following emission control systems: (EM) Engine Modifications and (TWC) Three-Way Catalyst (if so equipped).

GENERAL SAFETY PROCEDURES



SAFETY ALERT SYMBOL

The safety alert symbol is used with one of the safety words (**DANGER**, **WARNING**, or **CAUTION**) to alert you of hazards. Please pay attention to these hazard notices both in this manual and on the engine.

Please familiarize yourself with the following safety symbols and words:

- **DANGER**: Indicates a hazard that will result in serious injury or death if instructions are not followed.
- **WARNING**: Indicates a strong possibility of causing serious injury or death if instructions are not followed.
- **CAUTION**: Indicates a possibility of personal injury or equipment damage if instructions are not followed.



DANGER: This generator produces poisonous carbon monoxide gas when running. This gas is both odorless and colorless. Even if you do not see or smell gas, carbon monoxide may still be present. Breathing this poison can lead to headaches, dizziness, drowsiness, and eventually death.

- Use outdoors **ONLY** in non-confined areas.
- Keep several feet of clearance on all sides to allow proper ventilation of the generator.



WARNING: The exhaust from this product contains chemicals known to the State of California to cause cancer, birth defects, or other reproductive harm.



WARNING: This generator produces heat when running. Temperatures near exhaust can exceed 150°F (65°C).

- Do not touch hot surfaces. Pay attention to warning labels on the generator denoting hot parts of the machine.
- Allow generator to cool several minutes after use before touching engine or areas which heat during use.



WARNING: This generator may emit highly flammable and explosive gasoline vapors, which can cause severe burns or even death. A nearby open flame can lead to an explosion even if not directly in contact with gasoline.

- Do not operate near an open flame.
- Do not smoke near the generator.
- Always operate on a firm, level surface.
- Always turn the generator off before refueling.
- Allow generator to cool for at least 2 minutes before removing the fuel cap. Loosen cap slowly to relieve pressure in the tank.
- Do not overfill the gas tank. Gas may expand during operation. Do not fill to the top of the tank.
- Always check for spilled gas before operating.
- Empty the gasoline tank before storing or transporting the generator.
- Before transporting, turn the fuel valve to the off position and disconnect the spark plug.



WARNING: This generator produces a powerful voltage, which can result in electrocution.

- ALWAYS ground the generator before using it (see the “Grounding the Generator” portion of the “PREPARING THE GENERATOR FOR USE”).
- The generator should only be plugged into electrical devices, either directly or with an extension cord. NEVER connect to a building electrical system without a qualified electrician. Such connections must comply with local electrical laws and codes. Failure to comply can create a backflow of power, which may result in serious injury or death to utility workers.
- Use a ground fault circuit interrupter (GFCI) in highly conductive areas such as metal decking or steelwork. GFCIs are available in-line with some extension cords.
- Do not use uncovered in rainy or wet conditions.
- Do not touch bare wires or receptacles (outlets).
- Do not allow children or non-qualified persons to operate.

GENERAL SAFETY PROCEDURES

In addition to the above safety notices, please familiarize yourself with the safety and hazard markings on the generator.



⚠ DANGER



DO NOT OVERFILL THE GAS TANK
OVERFILLING CAN RESULT IN A FIRE, EXPLOSION, OR DEATH.

⚠ DANGER

Using a generator indoors CAN KILL YOU IN MINUTES. Generator exhaust contains carbon monoxide. This is a poison you cannot see or smell.

		
NEVER use inside a home or garage, EVEN IF doors and windows are open.		Only use OUTSIDE and far away from windows, doors, and vents.

Avoid other generator hazards.
READ MANUAL BEFORE USE



Duro Max NEXT GENERATION POWER SYSTEMS

READ
READ USER MANUAL BEFORE OPERATING THIS PRODUCT

CAUTION
This generator is not to be used for medical purposes. Do not use for medical purposes. Do not use for medical purposes. Do not use for medical purposes.

DANGER
HIGH VOLTAGE ELECTRICAL

DO NOT REMOVE THIS WARNING LABEL

DANGER
OPERATION OF THIS GENERATOR MAY CREATE SPARKS THAT CAN START FIRES. ALWAYS USE PROPER SAFETY PROCEDURES. ALWAYS USE PROPER SAFETY PROCEDURES. ALWAYS USE PROPER SAFETY PROCEDURES.

DANGER
OPERATING, SERVICING AND MAINTAINING A GENERATOR OR OFF-GRID SYSTEM INVOLVES SERIOUS RISKS. ALWAYS USE PROPER SAFETY PROCEDURES. ALWAYS USE PROPER SAFETY PROCEDURES. ALWAYS USE PROPER SAFETY PROCEDURES.

AUTOMATIC SHUTOFF
CO TEST
Please consult your owner's manual for additional information.

DANGER
ONLY OPERATE GENERATOR IN AN OPEN OUTDOOR AREA AT LEAST 5 FEET AWAY FROM ANY FLAMMABLE MATERIAL. ALWAYS EXHAUST AWAY FROM STRUCTURES. DON'T ALARM GENERATORS IN ENCLOSED AREAS. NOT IN-USE OR CHARGING.

MOVE TO FRESH AIR AND GET MEDICAL HELP IF SICK, DIZZY OR WEAK



CARBON MONOXIDE SAFETY

Carbon Monoxide



Generators are convenient, but they can also be dangerous. All fuel-burning appliances and equipment release a poisonous gas called carbon monoxide.

Carbon monoxide (also known as CO) can be dangerous for humans and pets, even in small amounts, because it blocks oxygen from getting into your body. Carbon monoxide poisoning can lead to death in a very short time. It is odorless, tasteless and invisible, so you may be exposed without knowing it. That is why carbon monoxide is sometimes called “the silent killer.”

CO-ALERT



Description

The DuroMax CO-ALERT system was created to protect our customers and their families from dangerous carbon monoxide. Just like the detector for your home the CO-ALERT tests the air for to keep you safe and healthy.



CO Detected

If dangerous carbon monoxide levels are detected:

- The indicator will light red.
- The engine will shutdown.
- The engine will not restart for 5 minutes.



Maintenance Required

If an error in the CO-ALERT system is detected the indicator will light yellow. Please contact DuroMax service at 844-DUROMAX for assistance.



ALWAYS READ THE OWNER'S MANUAL FIRST

KNOW THE SYMPTOMS

- HEADACHE
- NAUSEA
- SHORTNESS OF BREATH
- DIZZINESS
- FATIGUE



IF YOU FEEL SYMPTOMS, LEAVE RIGHT AWAY

STAY ALERT WITH CARBON MONOXIDE DETECTORS

POINT FUMES AWAY FROM NEARBY PEOPLE

KEEP IT OUTSIDE AND AWAY FROM DOORS AND WINDOWS



PGMA
Portable Generator Manufacturers Association

As the only safe way to use a portable generator, taking your generator outside is absolutely mandatory to keep your family safe from carbon monoxide. But there's even more you can do. By educating yourself about all carbon monoxide risks, you'll be better prepared to protect your family from this colorless, odorless threat. Visit takeyourgeneratoroutside.com for more information.

TAKE IT OUTSIDE™



CARBON MONOXIDE KILLS

UNIT AND PURCHASE INFORMATION

Serial Number



Serial number

The serial number is located on the engine block, above and to the left of the oil fill.



Serial number format

The serial number will be shown in two parts. The engine model, followed by the serial number.

Engine Model: _____

Serial Number: _____

STAPLE RECEIPT HERE

A purchase receipt may be necessary for warranty parts or service in the future. If you have a paper receipt, staple it here for easy reference.

If you purchased the unit online, save the email receipt where you can access it, and record your details here for convenience in the future.

Purchase Date: _____

Order Number: _____

Retailer Name: _____



GENERATOR COMPONENTS

To help you get familiar with your new DuroMax generator, please see this component section for easy reference on all the generator's individual features.

GENERATOR COMPONENTS



1. **Recoil Start** - Easy pull recoil start to start the engine without the electric start.
2. **Air Cleaner** - A removable, cleanable, oiled, element that cleans the air going into the engine.
3. **Fuel Valve** - On/Off valve that allows gasoline to the fuel switch.
4. **Fuel Tank** - All metal 8.3 gallon gasoline fuel tank.
5. **Power Panel** - Contains the start switch, plugs, meters, and circuit breakers.
6. **Handles** - Longest handles of any DuroMax model allow easy movement across any surface
7. **Battery** - 12V DC battery that powers the electric start system.
8. **Oil Fill and Dipstick** - Use to add or check the oil.
9. **Engine Switch** - Push button start switch. Press for 1 second to start the generator. Hold for 3 seconds to stop the generator.
10. **Charging Light** - Will light when the generator is charging the on-board battery.
11. **Low Oil Alert** - Will light only if the generator shuts down due to low oil.
12. **Battery Switch** - Prevents battery discharge during storage.

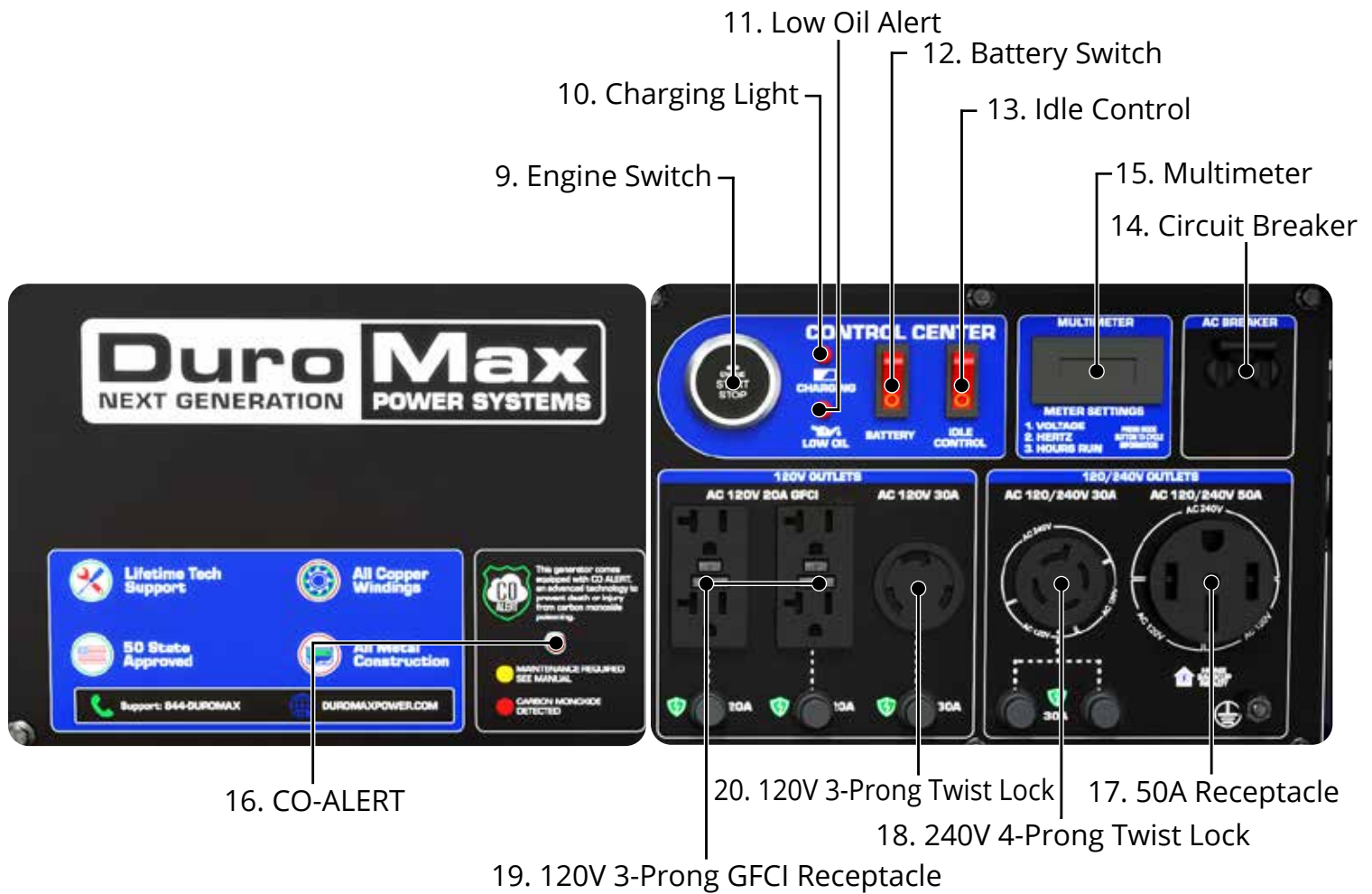

- 13. **Idle Control** - Slows the engine to save fuel and lower noise when no load.
- 14. **Circuit Breaker** - Protects the panel from overload and short circuits.
- 15. **Multimeter** - Displays voltage, hertz, and time running.
- 16. **CO-ALERT** - Shuts down the engine in the event of CO buildup.
- 17. **50A Receptacle** - Use to connect electrical devices that run 120 or 240 volt, 60Hz, single-phase, AC current (NEMA 14-50).
- 18. **240V 4-Prong Twist Lock** - Use to connect electrical devices that run 120 or 240 volt, 60Hz, single-phase, AC current (NEMA L14-30).
- 19. **120V 3-Prong GFCI Receptacle** - Use to connect electrical devices that run 120 volt, 60Hz, single-phase, AC current (NEMA 5-20).
- 20. **120V 3-Prong Twist Lock** - Use to connect electrical devices that run 120 volt, 60 Hz, single-phase, AC current (L5-30).

PACKAGE CONTENTS

Your generator comes with the items listed below. Please check to see that all of the following items are included with your generator.



Double-Sided Screw Driver

Phillips and slot blade screwdriver used for generator maintenance.



Spanner

Assorted wrenches used in generator maintenance and assembly. 10mm/12mm, 13mm/15mm, and 17mm/19mm.



Spark Plug Wrench

Used in spark plug maintenance, inspection, and installation.



Oil Funnel w/ Hose

Used to add oil to the generator without messy spills.



Plug Ends

Plug heads for the receptacles found on the generator are included to make or rewire your own cords.

- Note: Actual tools may differ in appearance or design from the image shown.



GENERATOR SETUP

Proper setup of your generator will get you going as soon as possible while making sure you and your equipment are safe and cared for.



POWERING EVERYONE...
ANYWHERE!

GENERATOR SETUP

Step 1 - Remove Shipping Braces

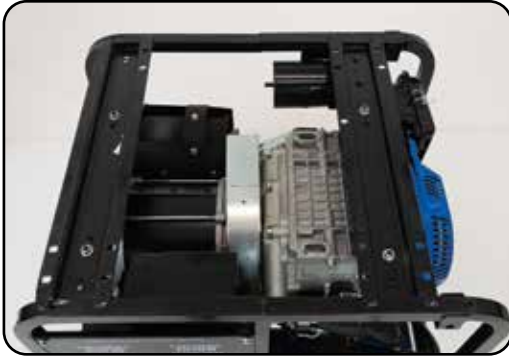

1. Unpack

- a. Remove the generator from the box.
- b. Place the largest piece of packing foam on a flat surface.
- c. Flip the generator upside down on the pad.



CAUTION: NEVER attempt this if you have put fuel or oil in the generator.



2. Remove braces

- a. The shipping braces prevent engine movement during shipment. Flip the generator over and remove the brightly colored braces between the motor and the frame, and the wood brace under the generator.



Note: Shipping braces can be thrown away, they will not be needed again.

GENERATOR SETUP (CONTINUED)

Step 2 - Wheel Kit Installation (Optional)



1. Install support legs

- a. Secure the support legs to the frame with the provided lock nuts.



2. Install wheel axles

- a. Place the smallest washer onto the wheel axle bolts.
- b. Insert wheel axle bolts through the frame and secure with the provided nut and wrenches.



3. Install inside wheel washers

- a. Place one of the large washers onto the axles.



4. Install wheels

- a. Place the wheels onto the axles.



5. Install outside wheel washers

- a. Place the other large washers onto the axles.



6. Install cotter pins

- a. Place the cotter pin through the hole at the end of the axle and bend it out to secure the wheel.



7. Install handles

- a. Attach the handles to the brackets on the frame using the provided bolts and nuts.



CAUTION: Do not over-tighten the handles, it will prevent free movement.



8. Flip over assembled

- a. Flip the assembled generator over onto its wheels and support brackets.

GENERATOR SETUP (CONTINUED)

Step 3 - Connect the Battery



1. Remove the battery cover

- a. Remove the battery cover plate using the wrench from the toolkit.



2. Locate the negative cable

- a. Locate the negative battery cable above and behind the battery. One side is connected to ground and the other end needs to be connected to the battery.
- b. Route the free end to the negative battery terminal.



3. Connect the negative cable

- a. Push the black rubber boot up the wire to expose the connector.
- b. Securely connect the free end of the battery cable to the negative battery terminal using the screw and nut from the battery with the screwdriver and wrench from the toolkit.



4. Reinstall the battery plate

- a. Cover the connected terminal with the black rubber boot.
- b. Reinstall the battery cover plate using the wrench from the toolkit.

Step 4 - Adding Oil

The generator requires engine oil to operate properly. The generator, when new from the package, contains no oil in the crankcase*. You must add the proper amount of oil before operating the generator for the first time. This amount is equal to the oil capacity of the engine crankcase:

Model Number	XP13000X
Engine Oil Capacity	40.5 fl. oz. (1.2L)



WARNING: Do not apply engine oils with additives or 2-stroke gasoline engine oils; they don't have enough lubrication and may shorten the engine's service life.

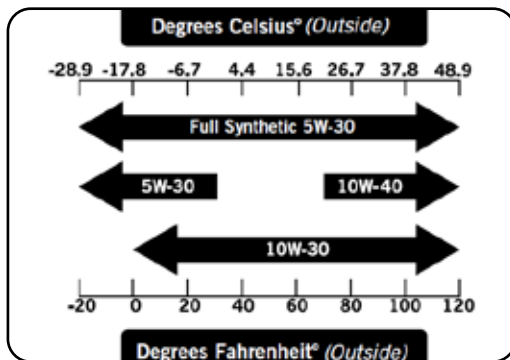

Engine oil recommended: SAE 10W-30.

Viscosity varies with regions and temperatures. Choose your oil viscosity using the chart to the left.

* A small amount of oil from factory testing may be present on arrival.

* Synthetic oil may be used after the 8 hour initial break-in period. Using synthetic oil does not increase the recommended oil change interval. Full synthetic 5W-30 oil will aid in starting in cold temperatures <5°C (41°F).



Add oil

- Make sure the generator is on a level surface.
- Unscrew the oil filler/dipstick cap from the engine.
- Using a funnel, add the appropriate amount of oil into the crankcase. You will know the crankcase is full when the oil level has reached the lower lip of the opening you have just poured the oil into.
- Replace the oil filler cap.



WARNING: Do not overfill the crankcase. This may damage the motor and shorten the overall life of your generator.

GENERATOR SETUP (CONTINUED)

Step 5 - Adding Gasoline (Optional)



Add gasoline

- Make sure the generator is on a level surface.
- Unscrew gas cap and set aside (NOTE: the gas cap may be tight and hard to unscrew).
- Slowly add unleaded gasoline to the fuel tank. Be careful not to overfill. The fuel gauge on the top of the gas tank indicates how much gasoline is in the generator gas tank.
- Replace fuel cap and wipe up any spilled gasoline with a dry cloth.

Model Number	XP13000X
Gas Tank Capacity	8.3 US gal. (31L)



WARNING: Gas can expand. Do not fill the gas tank to the very top. Leave a minimum of 1.5 in open space. Gasoline and gas fumes are highly flammable. Do not fill the tank near an open flame. Always check for fuel spills.

IMPORTANT:

- To ensure that the generator runs smoothly use only FRESH, UNLEADED GAS WITH AN OCTANE RATING OF 87 OR HIGHER.
- Never use an oil/gasoline mixture. Never use old gas.
- Avoid getting dirt or water in the fuel tank.
- Gas can age in the tank and make it hard to start up the generator in the future.
- Never store generator for extended periods of time with fuel in the tank.

Step 6 - Grounding the Generator



Attach grounding wire

- Ground the generator by tightening the grounding nut against a grounding wire.
- Connect the other end to a copper or brass grounding rod that's driven into the earth.

A generally acceptable grounding wire is a No. 12 AWG (American Wire Gauge) stranded copper wire.



Grounding codes can vary by location. Please contact a local electrician to check the grounding regulations for your area.

Note: If the generator is connected to a home, then it won't be necessary to attach the separate grounding wire and you can opt to use your home ground instead. Please see a certified electrician for further options with grounding your generator.



WARNING: Failure to properly ground the generator can result in electrocution.

High Altitude Operation

At high altitudes, the standard carburetor air/fuel mixture will be too rich. The performance will decrease, and fuel consumption will increase. A very rich mixture will also foul the spark plug and cause hard starting. Operation at an altitude that differs from that at which this engine was certified, for extended periods of time, may increase emissions. High altitude performance can be improved by specific modifications to the carburetor. If you always operate your generator at altitudes above 3,000 feet (900 meters), have a dealer perform this carburetor modification. This engine, when operated at high altitude with the carburetor modifications for high altitude use, will meet each emission standard throughout its useful life. Even with carburetor modification, engine horsepower will decrease by about 3.5% for each 1,000-foot (300-meter) increase in altitude. The effect of altitude on horsepower will be greater than this if no carburetor modification is made.

When the carburetor has been modified for high altitude operation, the air/fuel mixture will be too lean for low altitude use. Operation at altitudes below 3,000 feet (900 meters) with a modified carburetor may cause the engine to overheat and result in serious engine damage.



POWERING EVERYONE...
ANYWHERE!



STARTING THE GENERATOR

If this is not your first time using the generator there are still steps you should take to prepare it for operation each time you use it.

IMPORTANT: At this point, you should be familiar with the procedures described in the first portion of this section entitled "GENERATOR SETUP" If you have not yet read this section, go back and read it now.

BEFORE YOU START YOUR GENERATOR

Step 1 - Check the Oil



Check the oil

The generator is equipped with an automatic shutoff to protect it from damage due to low oil. Nonetheless, you should check the oil level of the engine before each use to ensure that the engine crankcase has a sufficient amount.

To check the oil level:

- a. Make sure the generator is on a level surface.
- b. Unscrew the oil filler/dipstick cap.
- c. With a dry cloth, wipe the oil off of the stick on the inside of the cap.
- d. Insert the dipstick as if you were replacing the cap and then remove it again. There should now be oil on the stick. If there is no oil on the stick, or oil only at the very end of the stick, you should add oil until the engine crankcase is filled (see “Adding Oil” portion of the “Maintenance” section).
- e. Be sure to replace the cap when finished checking oil.



Model Number	XP13000X
Engine Oil Capacity	40.5 fl. oz. (1.2L)

Step 2 - Check the Gas Level (Optional)



Check fuel level

If running the engine on gasoline, check to see that there is sufficient gasoline in the fuel tank. The fuel gauge on top of the tank will give a rough estimate of the gasoline level. The gauge will appear white then fill red as the tank is filled.

Note: Fuel gauge may not register with less than 1/3 fuel tank full.



WARNING: Gasoline and gasoline fumes are highly flammable.

- Do not fill the tank near an open flame.
- Always allow the engine to cool for several minutes before refueling.
- DO NOT overfill the fuel tank. Fuel expands when shaken or heated. ALWAYS leave 1½" space or more at the top of the tank.
- ALWAYS use fresh fuel or stabilized fuel. Old gasoline (older than 30 days) can cause permanent damage to the fuel system.
- Always check for fuel spills.

STARTING THE GENERATOR

Starting the Generator



1. Turn breaker OFF

The breaker is located on the right side of the front power panel. Flip the breaker down to prevent accidental load when starting the generator.



2. Turn battery switch ON

The battery switch is located on the top center of the main power panel. Turn the switch "ON" to allow power to the push-button start.



3. Turn idle control OFF

The idle control is located on the top center of the main power panel. Turn the switch "OFF" to prevent the unit from trying to idle down before the engine is warmed up.



4. Start the generator

The push-button start is located on the left side of the main power panel. Press the button for 1 second and release to start the generator.



5. Turn breaker ON/ Connect

The breaker is located on the right side of the front power panel. Flip the breaker up to allow the power to flow to the receptacles. Connect your devices to the receptacles on the front panel. Start with the largest loads first.



CAUTION: Disconnect all electrical loads from the generator before attempting to start!



WARNING: Operating the starter motor for more than 5 seconds can damage the motor. If the engine fails to start, wait 10 seconds before operating the starter again.

STARTING THE GENERATOR (CONTINUED)

Starting the Generator Using Recoil Start



1. Shut breaker OFF

The breaker is located on the right side of the front power panel. Flip the breaker down to prevent accidental load when starting the generator.



2. Turn battery switch ON

The battery switch is located on the top center of the main power panel. Turn the switch "ON" to allow power to the push-button start.



3. Turn idle control OFF

The idle control is located on the top center of the main power panel. Turn the switch "OFF" to prevent the unit from trying to idle down before the engine is warmed up.



4. Close choke

The choke lever is located above the air filter to the left of the recoil start. Slide the lever to the right to cut the air supply and allow more gas into the engine to start.



5. Pull the recoil start

The recoil start is located on the left side panel next to the air filter. Pull the recoil handle slowly until resistance is felt, then quickly pull the recoil handle until fully extended.



CAUTION: Release the recoil handle only after the cord has retracted. Releasing the recoil handle while extended may cause harm to yourself or your equipment.

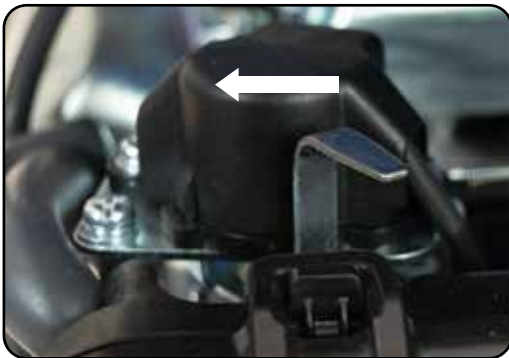

6. Open choke

After the engine has started, push the choke left to the “OPEN” position as the engine warms up.



7. Turn breaker ON/ Connect

The breaker is located on the right side of the front power panel. Flip the breaker up to allow the power to flow to the receptacles. Connect your devices to the receptacles on the front panel. Start with the largest loads first.



POWERING EVERYONE...
ANYWHERE!



USING THE GENERATOR

If this is not your first time using the generator there are still steps you should take to prepare it for operation each time you use it.

IMPORTANT: At this point you should be familiar with the procedures described in the first portion of this section entitled "GENERATOR SETUP" If you have not yet read this section, go back and read it now.

USING THE GENERATOR

AC Usage

- You may connect electrical devices running on AC current according to their wattage requirements.
- The chart below shows the rated and surge wattage of your generator according to its model number.
- The rated wattage corresponds to the maximum wattage the generator can output on a continuous basis.
- The surge wattage corresponds to the maximum amount of power the generator can output for a short period of time. In addition to the rated wattage listed by the device, many electrical devices such as refrigerators require short bursts of extra power to stop and start their motors. The surge wattage ability of the generator covers this extra power requirement.

Fuel Source	Rated (Running) Wattage	Surge (Peak) Wattage
Gasoline	10500	13000

The total running wattage requirement of the electrical devices connected to the generator should not exceed the rated wattage of the generator itself. To calculate the total wattage requirement of the electrical devices you wish to connect, find the rated (or running) wattage of each device. This number should be listed somewhere on the device or in its instruction manual.

If you cannot find this wattage, you may calculate it by multiplying the voltage requirement by the amperage drawn: $\text{watts} = \text{volts} \times \text{amps}$. If these specifications are not available, you may estimate the watts required by your device by using the chart on the next page.

Once you have found the rated wattage requirement of each electrical device, add these numbers to find the total rated wattage you wish to draw from the generator. If this number exceeds the rated wattage of the generator, DO NOT connect all these devices. Select a combination of electrical devices, which has a total rated wattage lower than or equal to the rated wattage of the generator.

Tool or Appliance	Rated (Running) Watts	Additional Surge Watts
Electric water heater (40 gal)	4000	0
Hot plate	2500	0
Radial arm saw	2000	2000
Electric stove	1500	0
Circular saw	1500	1500
Air compressor (1 HP)	1500	3000
Window air conditioner	1200	1800
Miter saw	1200	1800
Microwave	1000	2000
Well water pump	1000	1500
Reciprocating saw	960	1040
Sump pump	800	1200
Refrigerator freezer	800	1200
Furnace blower	800	1300
Computer	800	0
Electric drill	600	900
Television	500	0
Deep freezer	500	800
Garage door opener	480	600
Stereo	400	0
Box fan	300	600
Clock radio	300	0
Security system	180	0
DVD player	100	0
Common light bulb	75	0



CAUTION: The generator can only run at its surge wattage capacity for a very short time. Connect only electrical devices requiring a rated (running) wattage equal to or less than the rated wattage of the generator. Never connect devices requiring a rated wattage equal to the surge wattage of the generator.

*NOTE: The above wattage figures are estimates only.
Try to check the wattage listed on your electrical devices before consulting this chart.*

↑
SURGE GUARD
TRANSFER SWITCH
MODEL 4-20 10000V 60 A 60 Hz

FRON

DUAL FUEL XP13000HX

Duro Max
POWER SYSTEMS

OPERATION & SAFETY

- Fuel Selection
- Starting & Running
- Overload Protection
- Safety Precautions
- Maintenance

CONTROL CENTER

START STOP TEST

15 AMP 20 AMP 30 AMP 40 AMP 50 AMP 60 AMP

120V 240V

GASOLINE	PROPANE
13000 PEAK WATTS	1235 PEAK WATT
10500 RUNNING WATTS	9975 RUNNING WATTS

BATTERY POWER - ALWAYS USE TO RECHARGE BATTERY

Connecting the Generator to a Home



Extension cords

- The most straightforward and affordable option.
- Zero commitment, no installation needed: Simply plug in your appliances and go!
- Perfect for renters, RV/camping trips, and power on the job-site.



Transfer switch

- The safest, most effortless way to power your home.
- Automatically switches power over to your generator during an outage. Requires an electrician to install.
- Once you choose which circuits you want to power, you're locked into your configuration.



Interlock kit

- Choose what circuits you want to run.
- Requires an electrician to install, but you have the flexibility of switching up your circuits depending on your power needs.
- More hands-on, and some electrical knowledge is needed so you don't overload the generator.

USING THE GENERATOR (CONTINUED)

Connecting a Load to the Generator

NOTE: Be sure to attach devices to the correct receptacle (outlet).

- 120V devices can be directly connected to the 120V ONLY receptacles.
- 120V devices can be connected to the 120/240V receptacle using an appropriate adapter.
- 240V devices can ONLY be connected to the 240V receptacle.



CAUTION: Do not connect 50Hz or 3-phase loads to the generator.



1. Plug in devices

Plug in devices to the appropriate receptacle. When using the generator, balance the load as closely as possible. Placing more load on one side of the circuit will reduce the breaker trip period.



2. Turn breaker ON

Flip the circuit breaker up to the "ON" position to allow power to the receptacles.



3. Turn on connected devices

Start or turn on appliances, starting with the biggest loads first.

Choosing the Right Power Cord

Long or thin cords can drain the power provided to an electrical device by the generator. When using such cords, allow for a slightly higher rated wattage requirement for the electrical device. See the table below for recommended cords based on the power requirement of the electrical device.

DEVICE REQUIREMENTS		WIRE GAUGE BY LENGTH (ft.)				
AMPS	WATTS (120/240V)	10	25	50	100	150
5	600/1200	18	16	14	12	10
10	1200/2400	16	14	12	12	10
15	1800/3600	14	14	12	12	10
20	2400/4800	12	12	12	10	10
25	3000/6000	12	10	10	10	8
30	3600/7200	10	10	10	8	NR
40	4800/9600	8	8	6	6	NR
50	6000/12000	6	6	6	NR	NR
*NR = NOT RECOMMENDED		*Gauge based on twisted copper wire				

From home back up to just running your electric edger and everything in-between DuroMax has the power cord for you. All DuroMax cords are 100% twisted copper wire for maximum life and reliability.

Length	120V 15A					240V 30A	240V 50A
	14 Gauge	12 Gauge		10 Gauge		L14-30P/ L14-30R	14-50P/ CS6364
	Single Outlet	Single Outlet	Triple Outlet	Single Outlet	Triple Outlet		
10 ft						XP3010GC	
15 ft							XP5015GC
25 ft	XPC14025A	XPC12025A	XPC12025C	XPC10025A	XPC10025C	XP3025GC	XP5025GC
50 ft			XPC12050C	XPC10050A	XPC10050C	XP3050GC	XP5050GC
100 ft		XPC12100A	XPC12100C	XPC10100A	XPC10100C		

USING THE GENERATOR (CONTINUED)

Using the Digital Multimeter

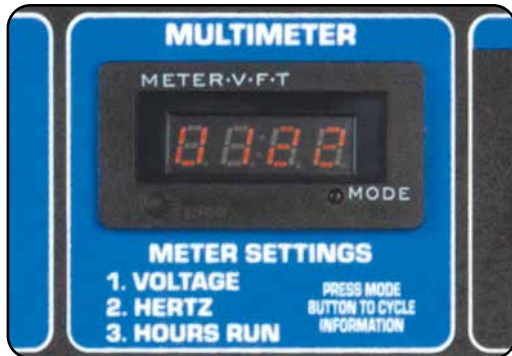

When the generator is started, the display will read the current voltage. Press the MODE button to cycle through the multimeter functions.



1. Voltage

The voltage currently produced by the generator in volts.



2. Frequency

The frequency currently produced by the generator in Hz.



3. Hours run

The number of hours the engine has currently been running.



4. Hours total

The number of hours the generator has been run in total.

Idle Control Usage

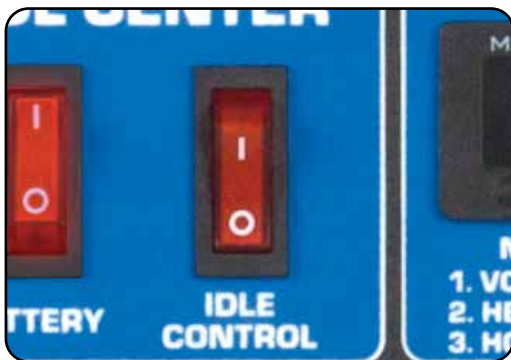

Idle control

The idle control feature lowers the RPM of the generator when there is no load to save gas and decrease engine noise.

When a load is applied, the engine will resume normal speed to provide usable power.

Turn on the idle control when using intermittent loads like power tools and air compressors.

The idle control feature is designed for gasoline only use.



WARNING: Power is unusable when idle control is engaged.

- DO NOT use the idle control function when using the generator for backup house power.
- Idle control function will cause massive fluctuations in voltage and hertz.
- Low amperage loads may not trigger the idle up function.



POWERING EVERYONE...
ANYWHERE!



MAINTENANCE AND CARE

Proper maintenance and storage of your generator is essential to ensure trouble free use of your generator when you need it.

By following the maintenance and care requirements, you can keep your generator running smooth and efficient for years to come.

MAINTENANCE AND CARE

Proper routine maintenance of your generator is essential for safe, economical, and trouble-free operation. It will also help reduce air pollution.



WARNING: Improper maintenance, or failure to correct a problem before operation, can cause a malfunction in which you can be seriously injured or killed. Always follow the inspection, maintenance recommendations, and schedules in this instruction manual.

- Make sure the engine is off before you begin any maintenance or repairs.
- Let the engine and exhaust system cool before touching.
- To reduce the possibility of fire or explosion, be careful when working around gasoline. Use only a nonflammable solvent, not gasoline, to clean parts. Keep cigarettes, sparks, and flames away from all fuel-related parts.

Maintenance Schedule

Remember that this schedule is based on the assumption that your machine will be used for its designed purpose. Sustained high-load, high-temperature operation, or use in unusually wet or dusty conditions, will require more frequent service.

SERVICE	EVERY USE	1ST MO. OR 8 HRS. (BREAK IN)	EVERY 3 MO. OR 50 HRS. OF HEAVY USE	EVERY 6 MO. OR 100 HRS. OF NORMAL USE	EVERY 12 MO. OR 300 HRS.	EVERY 3 YRS. OR 500 HRS.
ENGINE OIL	CHECK	CHANGE	CHANGE	CHANGE		
AIR CLEANER	CHECK	CHECK	CHANGE	CHANGE		
SEDIMENT CUP			CLEAN	CLEAN		
SPARK PLUG			CLEAN / ADJUST	CLEAN / ADJUST		
SPARK ARRESTOR	CHECK				CLEAN	
IDLE SPEED					CHECK / ADJUST	
VALVE CLEARANCE					CHECK / ADJUST	
FUEL TUBE	CHECK				CHECK / REPLACE	
FUEL TANK / FILTER					CLEAN	
COMBUSTION CHAMBER						CLEAN

Break-In Period

As the best practice for any new combustion motor it's recommended to perform the break in procedure as follows:

- Run the generator for the first 6-8 hours on conventional oil, then change the oil. After the break-in period synthetic oil may be used.
- During the break in period of the first 6-8 hours keep the generator load under 50% for optimal results.
- Check and clean the air filter if necessary after the break-in period.

Maintenance Log

As a best practice it's recommended to keep a log of the generator hours and maintenance to ensure your generator is always operating to its full potential.

Date	Generator Hours	Maintenance Performed

Checking the Oil



Check the oil

The generator is equipped with an automatic shutoff to protect it from damage due to low oil. Nonetheless, you should check the oil level of the engine before each use to ensure that the engine crankcase has a sufficient amount.

To check the oil level:

- a. Make sure the generator is on a level surface.
- b. Unscrew the oil filler/dipstick cap.
- c. With a dry cloth, wipe the oil off of the stick on the inside of the cap.
- d. Insert the dipstick as if you were replacing the cap and then remove it again. There should now be oil on the stick. If there is no oil on the stick, or oil only at the very end of the stick, you should add oil until the engine crankcase is filled (see “Adding Oil” portion of the “Maintenance” section).
- e. The oil will be visible in the oil fill spout when full.
- f. Be sure to replace the cap when finished checking oil.



Model Number	XP13000X
Engine Oil Capacity	40.5 fl. oz (1.2 L)

Changing the Oil



CAUTION: Worn out or dirty oil does not cool the generator properly and can lead to catastrophic engine damage.

In addition to regular oil changes, it is necessary to drain the oil from the crankcase if it has become contaminated with water or dirt.



1. Remove drain plug

Using a 12 mm hex wrench, unscrew the oil drain plug, which is located on the crankcase underneath the oil filler/dipstick cap.

Allow all the oil to drain from the generator.



2. Drain oil

Drain oil into an approved oil disposal container. Contact your local auto parts store for information on oil disposal.



3. Replace drain plug

Replace the oil drain plug and tighten with a 12 mm hex wrench.

Cleaning the Air Filter

MAINTAIN AIR FILTER

Clean air filter after every 50 hours of use
(every 10 hours in unusually dusty conditions)

Wash filter element with household detergents.
Wipe out dust from air filter housing before
replacing filter element.

Never clean with a brush

Routine maintenance of the air cleaner helps maintain proper airflow to the carburetor. Check that the air cleaner is free of excessive dirt after every use.



CAUTION: Improper maintenance may cause less air to enter the engine or dirty air to enter the engine causing overheating and engine wear.



1. Remove the filter cover screw

Remove the filter cover screw.



2. Remove filter cover

Remove the filter cover and the sponge-like element from the casing.



3. Clean out filter casing

Wipe the dirt from inside the empty air cleaner casing.



4. Wash cleaner element

Wash the sponge-like elements in household dish detergent and warm water.



5. Dry cleaner element

Pat dry on a dry cloth and allow the elements to dry completely.



6. Add engine oil to elements

Soak the dry elements in a small amount of engine oil. Ring out any excess oil.



7. Replace elements in casing

Replace the sponge-like elements in the air cleaner casing and replace the cover.

MAINTENANCE AND CARE (CONTINUED)

Spark Plug Maintenance



The spark plug is important for proper engine operation. A good spark plug should be intact, free of deposits, and properly gapped.



CAUTION: Improper maintenance may cause reduced fuel economy, misfires, trouble starting, or damage to the spark plug threads.



1. Remove spark plug cap

Pull on the spark plug cap to remove it.



2. Remove spark plug

Unscrew the spark plug from the generator using the spark plug wrench included with this product.



3. Inspect spark plug

Visually inspect the spark plug. If it is cracked or chipped, discard and replace it with a new spark plug. We recommend using an F6RTC spark plug such as NGK BPR6ES.



4. Measure plug gap

Measure the plug gap with a gauge. The gap should be 0.7-0.8 mm (0.028-0.031 in).



5. Clean and re-gap

If you are re-using the spark plug, use a wire brush to clean any dirt from around the spark plug base and then re-gap the spark plug.



6. Install spark plug

Screw the spark plug back into its place on the generator using the spark plug wrench.



7. Replace spark plug cap

Replace the spark plug cap.

Emptying the Gas Tank



If you have been using gasoline in your generator, before storing your generator for extended periods of time you should drain your generator fuel tank of gasoline.



CAUTION: Do not store fuel from one season to another. Gasoline sold at the pump today contains additives such as ethanol that even when stored properly may damage the fuel system components.

1. Shut fuel valve OFF

Turn the fuel valve to the “OFF” position.



2. Remove fuel filter cup

Remove the fuel filter cup (see “Removing the Fuel Filter Cup” earlier in this section).



3. Empty fuel filter cup

Empty the fuel filter cup of any fuel.





4. Drain gas from the generator

With a funnel underneath the fuel valve to catch the gas, turn the fuel valve to the "ON" position. Drain all the gas from the generator.



5. Shut fuel valve OFF

Turn the fuel valve to the "OFF" position.



6. Replace fuel filter cup

Reinstall the fuel filter cup.



7. Store emptied gas

Store the emptied gasoline in a suitable place and add fuel stabilizer to keep fuel fresh and usable.

Cleaning the Fuel Filter Cup

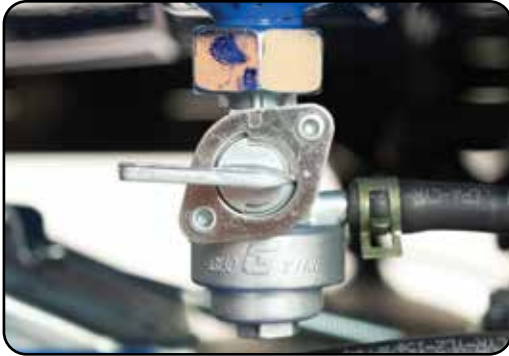

1. Shut fuel valve OFF

Turn the fuel valve to the "OFF" position.



2. Remove fuel filter cup

Unscrew the fuel filter cup from the fuel valve using a wrench.



3. Clean filter cup

Clean the cup of all sediment using a rag or brush.



4. Replace fuel filter cup

Reinstall the fuel filter cup.

Transporting the Generator



1. Empty the gas tank

Fully drain your gas tank as shown in “Emptying the Gas Tank” on page 56-57.



2. Disconnect the spark plug

Pull on spark plug cap to disconnect spark plug from ignition wire.



CAUTION: Do not obstruct any ventilation openings and keep the generator in a cool dry area.



CAUTION: Never place any type of storage cover on the generator while it is still hot.

MAINTENANCE AND CARE (CONTINUED)

Storing the Generator for Same Day Use

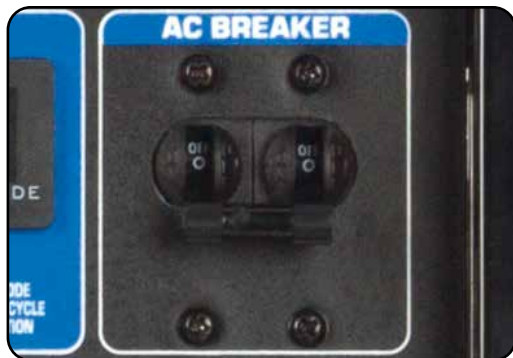

1. Turn the main breaker OFF

Move the main breaker to the "OFF" position.



2. Run the generator

Allow the generator to run for 3-5 minutes.



3. Turn the generator OFF

Hold the start button for 3 seconds to shut off the generator.



4. Turn battery switch OFF/ Store

Turn the battery switch to the "OFF" position, and store the generator.



CAUTION: Do not obstruct any ventilation openings and keep the generator in a cool dry area.

Storing the Generator for Use Within 30 Days



1. Turn breaker OFF and run

Follow steps 1 and 2 as shown on "Storing the Generator For Same Day Use" on page 60.



2. Shut fuel valve OFF and run dry

Shut the fuel valve "OFF" and allow generator to run until it stalls out.



3. Turn the battery switch OFF

Turn the battery switch to the "OFF" position.



4. Add fuel stabilizer and store

Add fuel stabilizer to gas remaining in tank, and store generator.

MAINTENANCE AND CARE (CONTINUED)

Storing the Generator for Longer Than 30 Days

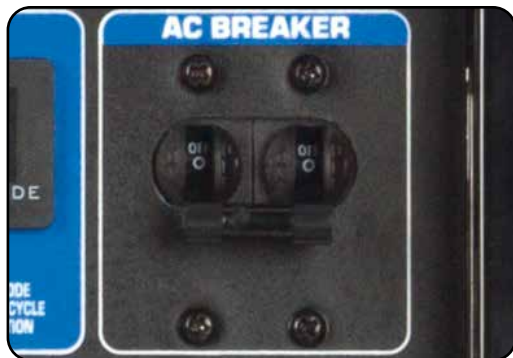

1. Turn breaker OFF and run

Follow steps 1 and 2 as shown on “Storing the Generator For Same Day Use” on page 60.



2. Shut fuel valve OFF and run dry

Shut the fuel valve “OFF” and allow generator to run until it stalls out.



3. Turn the battery switch OFF

Turn the battery switch to the “OFF” position.



4. Empty the gas tank

Fully drain your gas tank as shown in “Emptying the Gas Tank” on page 56-57.



5. Drain the carburetor

Remove drain bolt from carburetor and drain small amount of fuel in carburetor bowl.



6. Remove spark plug

Remove spark plug as shown in "Spark Plug Maintenance" on page 54.



7. Add oil to cylinder

Add 2 tablespoons of 10W-30 motor oil directly into the spark plug hole, and pull the recoil to lubricate cylinder. After lubricating cylinder reinstall the spark plug.



8. Remove battery and charge

Remove the generator battery and place it on a 12V battery tender indoors.

SPECIFICATIONS

Model Number	XP13000X
AC Rated Wattage	10,500 W
AC Surge Wattage	13,000 W
AC Rated Voltage	120/240V
Dimensions	30"L x 29"W x 26"H
Weight	240 lbs
Recommended Oil	10W-30
Engine Displacement	500 cc
Gasoline Capacity	8.3 gal
Oil Capacity	40.5 fl. oz. (1.2 L)
Bore	94 mm
Stroke	72 mm
Engine Speed	3600 rpm
Oil Cooling Type	Splash
Bearing Type	Stainless steel ball bearing
Cylinder Sleeve	Cast iron sleeve
Fuel Delivery System	Carburetor
Valve Type	OHV
Engine Type	4-Stroke
Engine Cooling Type	Forced air
Run Time @ 50%	8.5 hr.
Starting Type	Electric/ Recoil
Noise Level	<74 dB
Neutral System	Floating
AC Rated Frequency	60 Hz
AC Phase	Single
Winding Material	100% copper windings
Emissions Compliance	EPA/CARB



TROUBLESHOOTING

This section of the manual is to help you troubleshoot problems with your generator.

TROUBLESHOOTING

Problem	Description	Solution
The engine will not start	Engine switch is "OFF"	Set engine switch to "RUN"
	Fuel Valve is "OFF"	Turn the fuel valve to "ON"
	Choke is open	Close the choke
	The engine is out of fuel	Add fuel
	Fuel is old or contaminated	Change fuel
	Spark plug is dirty	Clean spark plug
	Spark plug is broken	Replace spark plug
	The generator is not level	Move the generator to a level surface
	Oil is low	Add/ change the oil
Engine runs, but there is no electrical output	The circuit breaker is "OFF"	Turn "ON" circuit breaker
	Wiring connection is bad	Replace extension cord(s)
	Device connected to generator is malfunctioning	Disconnect malfunctioning device
The generator runs but does not support all electrical devices connected	Generator is overloaded	Disconnect 1 or more items to reduce the load
	Device connected to the generator is bad	Disconnect malfunctioning device
	The air filter is dirty	Clean/ replace the air filter

Changing/ Inspecting the Carbon Brushes



The carbon brushes in conjunction with the AVR regulates power from the generator. The carbon brushes are wearable parts and should be inspected every 250 running hours.



1. Remove generator cover

Remove the 2 bolts of the generator cover then pull the cover off the generator.



2. Remove bolt from brush

Remove the bolt holding the carbon brush.



3. Disconnect AVR wires

Remove the two wires from the AVR on the carbon brush.

■ TROUBLESHOOTING (CONTINUED)

Changing/ Inspecting the Carbon Brushes (Cont.)



4. Install new brush

Install new carbon brush with bolt.



5. Connect AVR wires

Insert and connect the 2 wires from the AVR, be sure to connect + and - correctly.



6. Replace generator cover

Replace the back cover of the generator and secure it with the 2 bolts.

Changing/ Inspecting the AVR



The carbon brushes in conjunction with the AVR regulates power from the generator. If the generator is overheated or overloaded, the AVR may be damaged and require replacement.



1. Remove generator cover

Remove the 2 bolts of the generator cover then pull the cover off the generator.



2. Remove AVR bolts

Remove the 2 bolts holding the AVR.



3. Disconnect AVR wire clip

Disconnect the wire clip.

■ TROUBLESHOOTING (CONTINUED)

Changing / Inspecting the AVR (Continued)



4. Disconnect wires from brush

Remove the 2 wires from the AVR on the carbon brush.



5. Install new AVR

Install the new AVR with the 2 bolts.



6. Reconnect wires to brush

Insert and connect the 2 wires from the AVR, be sure to connect + and - correctly.



7. Reconnect the AVR wire clip

Reconnect the wire clip.



8. Replace generator cover

Replace the back cover of the generator and secure it with the 2 bolts.

WIRING DIAGRAM

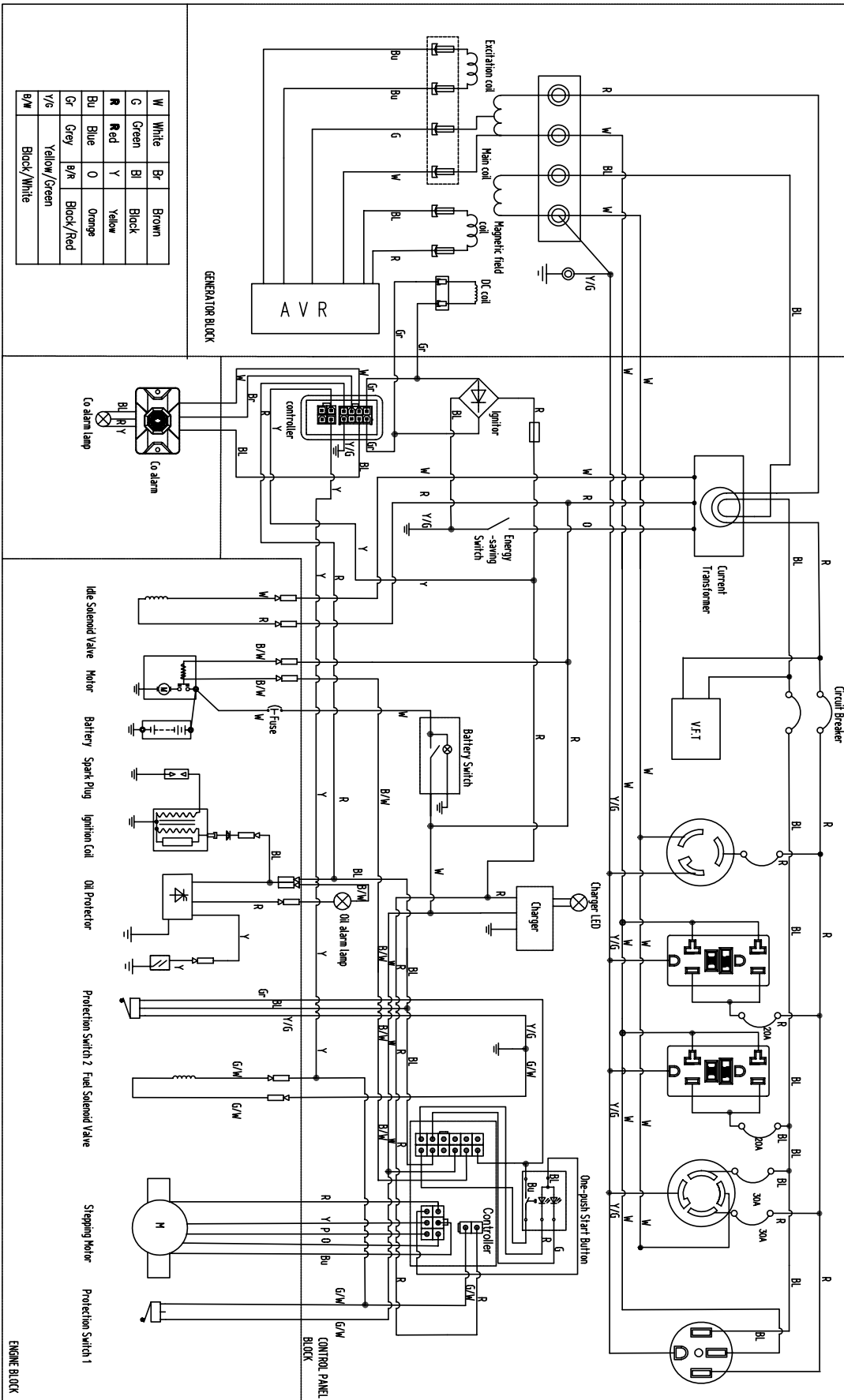



POWERING EVERYONE...
ANYWHERE!

WARRANTY

5-year Warranty

All DuroMax Power Equipment warrant the original purchasers to a 5-year Parts Warranty (Residential Use ONLY: Unusually heavy or commercial use is covered for a period of 1-year) in the event of failure due to defects in electrical or mechanical components. Freight on any items submitted for replacement or repair under the Warranty is the responsibility of the equipment owner. This warranty is non-transferable and only valid to the original purchaser.

Warranty Exclusions

The DuroMax Power Equipment warranty does not cover repairs or returns when the fault is: Normal Wear and Tear, Installation Use or Maintenance Services, Cosmetic defects, Accessories, Failures due to acts of God or Natural Disasters, or problems related to/from aftermarket or non-OEM parts.

Warranty Limitations

DuroMax Power Equipment does not claim or hold any obligation to loss of time, freight charges, use of the product, or any incidental damages from the use of this product. THIS WARRANTY IS IN LIEU OF ALL OTHER WARRANTIES, EXPRESSED OR IMPLIED.

U.S. FEDERAL AND CALIFORNIA EMISSIONS CONTROL WARRANTY STATEMENT YOUR WARRANTY RIGHTS AND OBLIGATIONS

The U.S. Environmental Protection Agency (EPA), California Air Resources Board, and DuroMax Power Equipment are pleased to explain the emissions control system's warranty on your 2022/2023 small off-road engine.

In California, new small off-road engines must be designed, built, and equipped to meet the State's stringent anti-smog standards. DuroMax Power Equipment must warrant the emissions control system on your small off-road engine for the period listed below provided there has been no abuse, neglect, or improper maintenance of your small off-road engine leading to the failure of the emission control system.

Your emissions control system may include parts such as: carburetors or the fuel injection system, ignition system, catalytic converters, fuel tanks, fuel lines (for liquid fuel and fuel vapors), fuel caps, valves, filters, clamps, connectors, and other associated components. Also, included may be hoses, belts, sensors, and other emission-related assemblies.

Where a warrantable condition exists, DuroMax Power Equipment will repair your small off-road engine at no cost to you including diagnosis, parts, and labor.

MANUFACTURER'S WARRANTY COVERAGE:

This emissions control system is warranted for two years. If any emissions-related part on your small off-road engine is defective, the part will be repaired or replaced by DuroMax Power Equipment.

OWNER'S WARRANTY RESPONSIBILITIES:

As the small off-road engine owner, you are responsible for performance of the required maintenance listed in your owner's manual. DuroMax Power Equipment recommends that you retain all receipts covering maintenance on your small off-road engine, but DuroMax Power Equipment cannot deny warranty coverage solely for the lack of receipts or your failure to ensure the performance of all scheduled maintenance.

As the small off-road engine owner, you should be aware that the DuroMax Power Equipment may deny you warranty coverage if your small off-road engine or a part has failed due to abuse, neglect, or improper maintenance or unapproved modifications.

You are responsible for presenting your small off-road engine to a DuroMax Power Equipment distribution center or service center as soon as the problem exists. The warranty repairs shall be completed in a reasonable amount of time, not to exceed 30 days.

If you have any questions regarding your warranty coverage, contact us at 844-387-6629 or email support@duromaxpower.com.

DEFECTS WARRANTY REQUIREMENTS:

The warranty period begins on the date the engine or equipment is delivered to an ultimate purchaser and extends for a period of Two Years.

GENERAL EMISSIONS WARRANTY COVERAGE:

DuroMax Power Equipment warrants to the ultimate purchaser and each subsequent owner that the engine or equipment is:

1. Designed, built, and equipped to conform with all applicable regulations adopted by the Air Resources Board; and
2. Free from defects in materials and workmanship that causes the failure of a warranted part for a period of two years.

The warranty on emissions-related parts will be interpreted as follows:

1. Any warranted part that is not scheduled for replacement as required maintenance in the Owner's Manual must be warranted for the warranty period stated above. If any such part fails during the period of warranty coverage, it must be repaired or replaced by DuroMax Power Equipment according to Subsection (4) below. Any such part repaired or replaced under the warranty must be warranted for a time not less than the remaining warranty period.

WARRANTY (CONTINUED)

2. Any warranted part that is scheduled only for regular inspection in the Owner's Manual must be warranted for the warranty period stated above. A statement in such written instructions to the effect of "repair or replace as necessary" shall advise owners of the warranty coverage for emission related parts. Replacement within the warranty period is covered by the warranty and will not reduce the period of warranty coverage. Any such part repaired or replaced under warranty must be warranted for a time not less than the remaining warranty period.
3. Any warranted part that is scheduled for replacement as required maintenance in the Owner's Manual must be warranted for the period prior to the first scheduled replacement point for that part. If the part fails prior to the first scheduled replacement, the part must be repaired or replaced by the engine manufacturer according to Subsection (4) below. Any such part repaired or replaced under warranty must be warranted for a time not less than the remainder of the period prior to the first scheduled replacement point for the part.
4. Repair or replacement of any warranted part under the warranty must be performed at no charge to the owner at a warranty station.
5. Notwithstanding the provisions of Subsection (4) above, warranty services or repairs must be provided at all manufacturer distribution centers that are franchised to service the subject engines.
6. The owner must not be charged for diagnostic labor that leads to the determination that a warranted part is in fact defective, provided that such diagnostic work is performed at a warranty station.
7. The manufacturer is liable for damages to other engine components proximately caused by a failure under warranty of any warranted part.
8. Throughout the emission control system's warranty period stated above, the manufacturer must maintain a supply of warranted parts sufficient to meet the expected demand for such parts and must obtain additional parts if that supply is exhausted.
9. Manufacturer-approved replacement parts that do not increase the exhaust or evaporative emissions of the engine or emissions control system must be used in the performance of any warranty maintenance or repairs and must be provided without charge to the owner. Such use will not reduce the warranty obligations of DuroMax Power Equipment.
10. Add-on or modified parts that are not exempted by the Air Resources Board may not be used. The use of any non-exempted add-on or modified parts will be grounds for disallowing a warranty claim made in accordance with this Article. DuroMax Power Equipment will not be liable under this Article to warrant failures of warranted parts caused by the use of an add-on or modified part.
11. DuroMax Power Equipment shall provide any documents that describe warranty procedures or policies within five working days of request by the Executive Officer.

Exhaust Emission Warranty Parts List.

1. Fuel Metering System
 - i. Carburetor and internal parts (and/or pressure regulator or fuel injection system).
 - ii. Air/fuel ratio feedback and control system.
 - iii. Cold start enrichment system.
2. Air Induction System
 - i. Controlled hot air intake system.
 - ii. Intake manifold.
3. Ignition System
 - i. Spark Plugs.
 - ii. Magneto or electronic ignition system.
 - iii. Spark advance/retard system.
4. Air Injection System
 - i. Air pump or pulse valve.
 - ii. Valves affecting distribution of flow.
 - iii. Distribution manifold.
5. Catalyst or Thermal Reactor System
 - i. Catalytic converter.
 - ii. Thermal reactor.
 - iii. Exhaust manifold.
6. Particulate Controls
7. Traps, filters, precipitators, and any other device used to capture particulate emissions.
8. Electronic controls.
9. Vacuum, temperature, and time sensitive valves and switches.
10. Hoses, belts, connectors, and assemblies.

Evaporative Emission Warranty Part List

1. Fuel Tank
2. Fuel Cap
3. Fuel Line (for liquid fuel and fuel vapors)
4. Fuel Line Fittings
5. Clamps*
6. Pressure Relief Valves*
7. Control Valves*
8. Control Solenoids*
9. Electronic Controls*
10. Vacuum Control Diaphragms*
11. Control Cables*
12. Control Linkages*
13. Purge Valves*
14. Gaskets*
15. Liquid/Vapor Separator
16. Carbon Canister
17. Canister Mounting Brackets
18. Carburetor Purge Port Connector

* Note: As they relate to the evaporative emission control system.

DuroMax Power Equipment will furnish with each new engine written instructions for the maintenance and use of the engine by the owner

CUSTOMER SERVICE

DuroMax Power Equipment is committed to ensuring that our products perform when they need to. Our generators are your lifeline in the event of an emergency. Should you have any problems, please contact our customer service department:

DUROMAX POWER EQUIPMENT
5800 Ontario Mills Parkway
Ontario, CA 91764

Customer Service: 844-DUROMAX
Customer Service Hours: 8-5 pm PST Mon-Fri

Website: www.duromaxpower.com
Email: customerservice@duromaxpower.com







5800 Ontario Mills Parkway
Ontario, CA 91764
United States

844-DUROMAX