

VEVOR[®]

**PROFESSIONAL HOME BREWING
MACHINE
INSTALLATION MANUAL**

VEVOR[®] PROFESSIONAL HOME BREWING MACHINE

DM-N30



NEED HELP? CONTACT US!

Have product questions? Need technical support? Please feel free to contact us:

 CustomerService@vevor.com

This is the original instruction, Please read all manual instructions carefully before operating. VEVOR reserves clear interpretation of our user manual. The appearance of the product shall be subject to the product you received. Please forgive us that we won't inform you again if there is any technology or software updates on our product.

Thank you for purchasing this microbrewery system.

Please follow the instructions to get the best use of your machine. The brewing process illustrated below is only a guide for reference. Since there are various brewing formulas and conditions, the results are accordingly different. This machine is designed for you to adjust the settings to meet your brewing requirements.

Safety Instructions

Please read all the instructions carefully, and keep this manual for future reference.

- Check the product's rating label and ensure that the device voltage fits your outlet voltage before use.
- The plug should be connected to the earth wire.
- Do not use the device if the cord or plug is damaged. It should be replaced before use.
- Do not use an adaptor as the wattage and power of this device are high.
- Switch off the button before removing the plug.
- Always switch it off before trying to move the water boiler.
- Be sure to avoid electric supply overloaded.
- As the device requires extra power, do not use extensions if under 13amp.
- This device requires a 13amp-16amp plug.
- Products may be connected to this extension.
- The device must be only used as intended. It must be operated in a safe, fault-free condition. Be sure to check the proper conditions before each use.
- The appliance is only to be installed in safe locations.
- Never dip the mash tun into water. Always protect the electric power cable from the mixture.
- **Do not switch on the water boiler if the water tank is empty.**
- **Do not remove the lid while boiling.**
- **DRY-BURNING: The machine is equipped with dry-burning protection. When the appliance is burnt, this function will be activated automatically. First, the dry-burning thermostat will cut out while the element overheats. Please fill some water inside or wait until the heating element cools down, then turn on the switch again. In case of burnt, please always make sure there are at least 3 liters of liquid inside. (The problems caused by dry-burning without adding water are not covered by the warranty! Although this machine is equipped with dry-burning protection, please pay attention when using it.)**
- **Please do not turn on the pump during wort boiling since air bubbles will cause the pump to idle and wear out under high temperatures. The machine damage caused by this reason is not under warranty coverage.**
- **It is not recommended to use the pump for pumping out the wort after cooling, as there is no filter on the pump inlet, which will cause brew debris to enter the pump, potentially blocking and damaging the system.**
- Switch off the pump after mashing. Please do not remove the curved pipe before closing the valve and switching off the pump.

What's In The Box

- The water temperature should be no higher than +40°C;
- The maximum submersing depth should not exceed 10m.
- The PH of water should be in 6.5-8.5.
- The maximum diameter of passable solid particles: Ø15~Ø35mm.



1	Digital Programmable Controller	5	Circulation Valve (Mash Flow Technology)
2	Switches (PCB / Power and Pump)	6	Connector (Cam-lock)
3	Tap	7	Circulation Tube (Mash Flow Technology)
4	Built-in Pump		

Parts

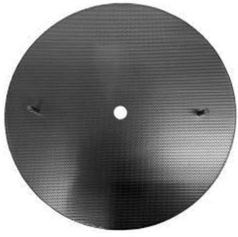

Top Sparge Plate
for Grain Basket

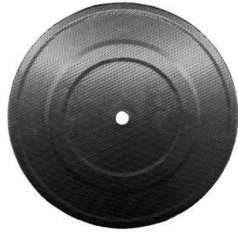

Bottom Sparge Plate
for Grain Basket



Glass Lid Cover with
Hole for Circulation Pipe



Bazooka Mesh
Filter for Tap



Circulation Pipe
(Cam-Lock Connector)



Bottom
Tube

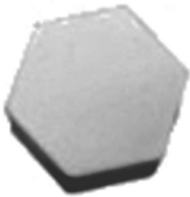

Grain Stopper: White Screw
Cap for Telescopic Overflow



Screw Nut for
Telescopic Overflow



Grain Basket



Grain Basket Handle





Telescopic Overflow Pipe
for Grain Basket



Operation

Switch Operation

The "PCB" switch is an ON/OFF switch for the power of the Digital Controller that controls the heating elements. The "PUMP" button is the ON/OFF switch for the pump.

	
Switch ON	Switch OFF

Tap Operation

		
Closed.	To open, pull the circle towards the end of the lever and turn the lever counterclockwise by 90°.	Open. To close, pull the circle towards the end of the lever and turn the lever clockwise by 90°.

Valve Operation

This valve serves to open and close the wort circulation. It is also used to set the correct wort flow during mashing.

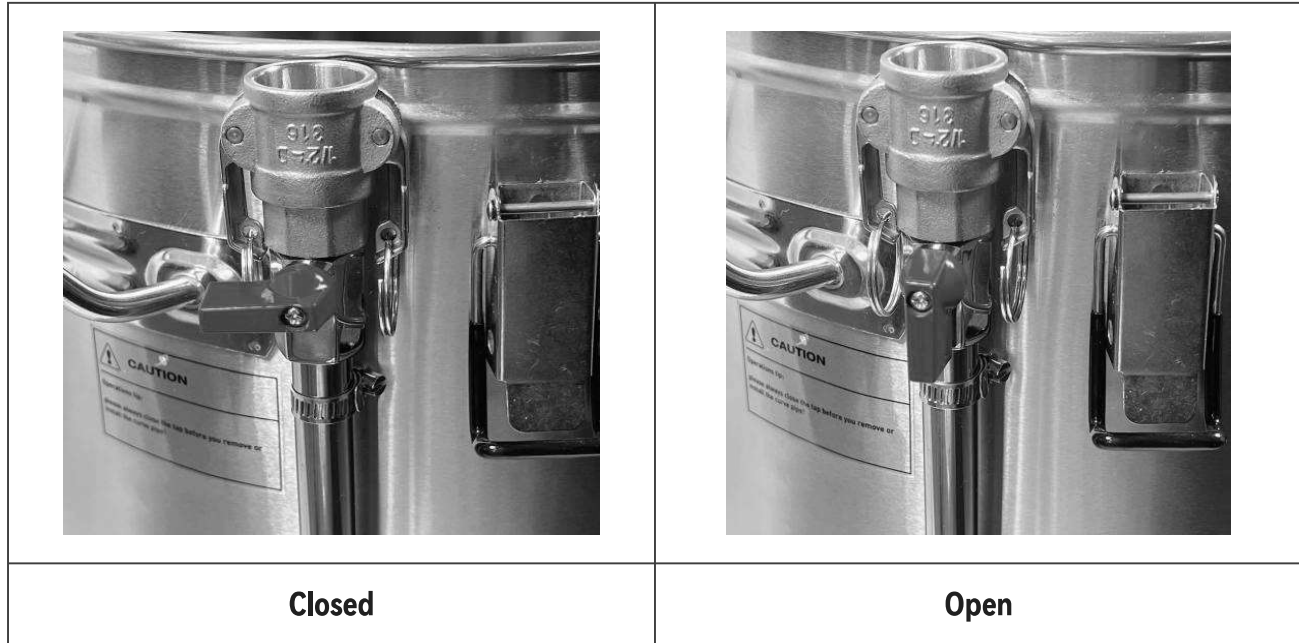

Note: Never open the circulation valve before assembling the circulation tube and make the tube go through the lid hole. Otherwise, the hot water or wort may cause burns.

Circulation Tube Assembly

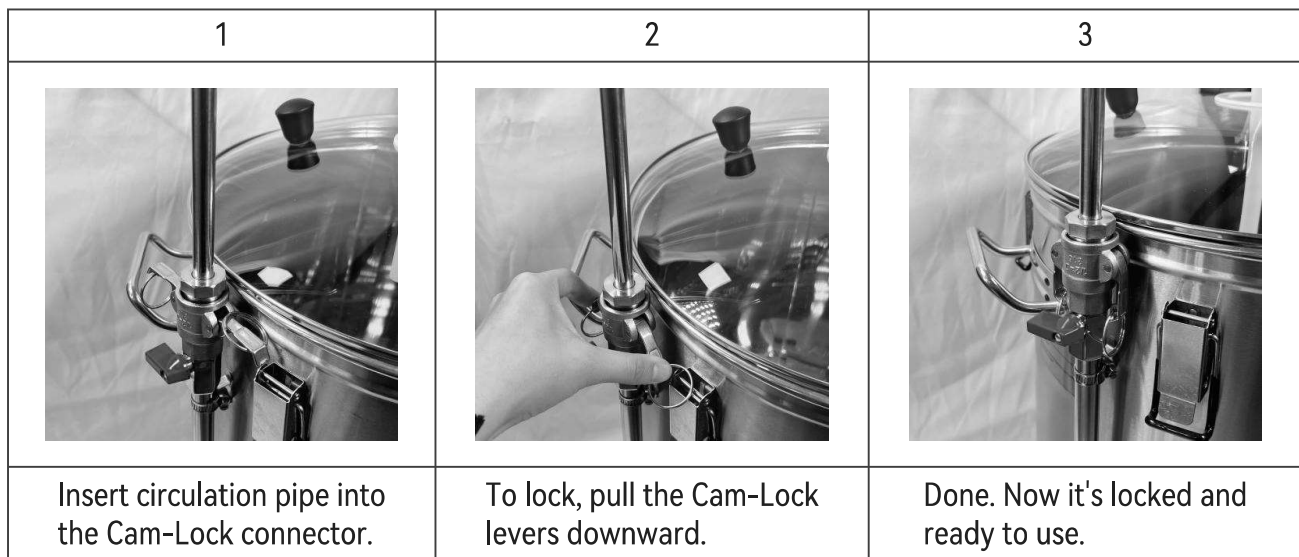

Note:

- Using the blue valve to adjust the flow rate for a correct circulation speed. If the pump speed is too fast, the grain basket will overflow down the central pipe, and the bottom of the boiler may run dry and cause ingredients to burn and overheat the heating element.
- Please adjust the flow until an excellent rate of circulation is achieved.



Grain Basket Assembly

1. Lift with the top handle and put the grain basket into the brewery. Then remove the handle.
2. Insert the overflow pipe assembly into the brewery. When adding the mash water and grains, remove the top sparge plate and add the grain stopper.
3. When the mashing is completed, lift the grain basket with the handle and hook its feet to the rim of the brewery. Then sparge.

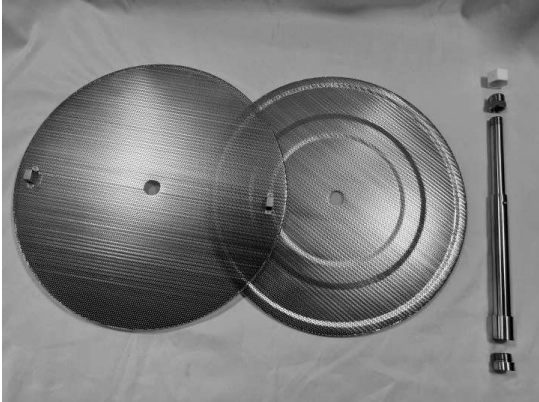

Grain Basket Overflow Pipe Assembly

Assemble the Grain basket's overflow pipe insert. This insert holds the malt grains in place inside the grain basket. The overflow pipe allows the wort to flow freely from the top sparge plate to the bottom if needed. The grain stopper screw cap is only used during mash-in, so the milled grain cannot fall into the overflow pipe. Remove it when all grains have been added. When adding the mash water and grains, remove the top sparge plate and add the grain stopper.

1	2
	
<p>Components prepared.</p>	<p>Assemble Use the bottom screw to connect the bottom sparge plate with the telescopic overflow pipe. Then attach the top screw nut to the telescopic overflow pipe.</p>

Bazooka Mesh Filter Assembly on Tap



Bottom Little Tube Assembly



Note: To prevent the malt from clogging the water hole, please insert this tube into the pump before using the device.

How To Use The Controller?

Control Panel and Key Functions

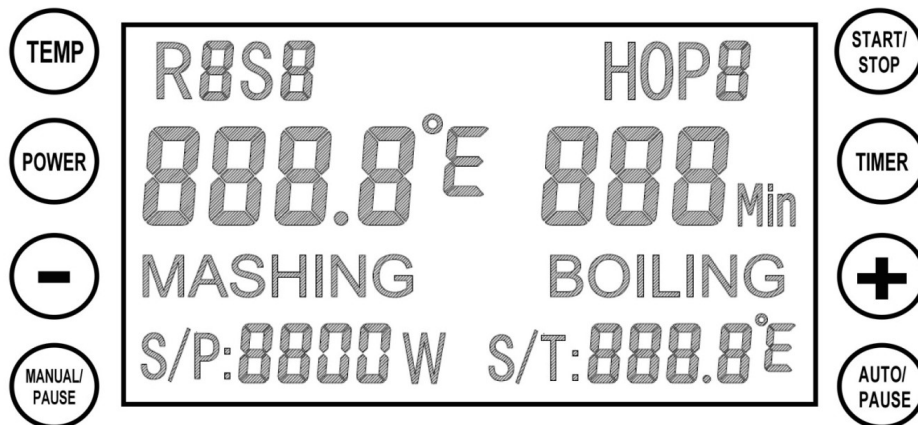

Temp Button	Press to set target temperature for each step.
Power Button	Press to set power for each step.
Timer Button	Press to set timer for each step.
"-" Button	Press to reduce the value.
"+" button	Press to increase the value.
Start/Stop	Press to start or stop the program.
Manual/Pause	Press to enter manual mode. Press to pause the program on manual mode.
Auto/Pause	Press to enter auto mode. Press to pause the program on auto mode.
S/P: W	Set the power.
S/T: °C	Set the temperature.
-H	When it's flashing, the element is heating to the target temperature.

Manual Mode Setting

1. Turn on the power switch, then press the **MANUAL** button.
2. **TEMP** is for Temperature setting, **POWER** is for Wattage setting, and **TIMER** is for session timing. All these 3 must be set before the device starts working. P.S. You can set these 3 settings in any order.
3. Press the **START** button when all the 3 settings have been made, and the manual session will start. An "**H**" flashing at the top left corner means the device is heating.
4. The default boiling temperature is 100°C in our program. The timer will not be triggered if the temperature does not indicate 100°C. In this case, please put the cover on for 1-2 mins. (or see below) to achieve 100°C on display.
5. If the device starts to boil, but shows a lower temp on display, make the following adjustment to set the temp at 100°C and trigger the timer.
6. Press the "-" and "+" buttons together until the display shows the C1/F1 sign. The temperature correction range is from -10°C to +10°C or -50°F to +50°F.
7. Press the Manual/Pause button during heating, and the device will return to the edit page. Then, you can edit Temp/Power/Timer. Press the Manual/Pause button again to confirm and device back to heating.
8. Long-press the **TEMP** button for 5 seconds to switch Celsius to Fahrenheit. This operation can only be preceded when you switch on the device before any setting.

Memory Function in Manual Mode

1. Press the **MANUAL/PAUSE** button in the **edit page** for 5 seconds and release it to record the last setting. There's a ringing sound of a bell for a successful recording.
2. Press the **START** button after the above operation, the device will go back to work and carry out the input data.
3. Press the **STOP** button, and the device will stop working.
4. Long-press the **AUTO/PAUSE** button in the **BLANK PAGE** as below (display shows the current temperature only as below) for 5 seconds to restore factory settings. There's a slower ringing for successful restoring.



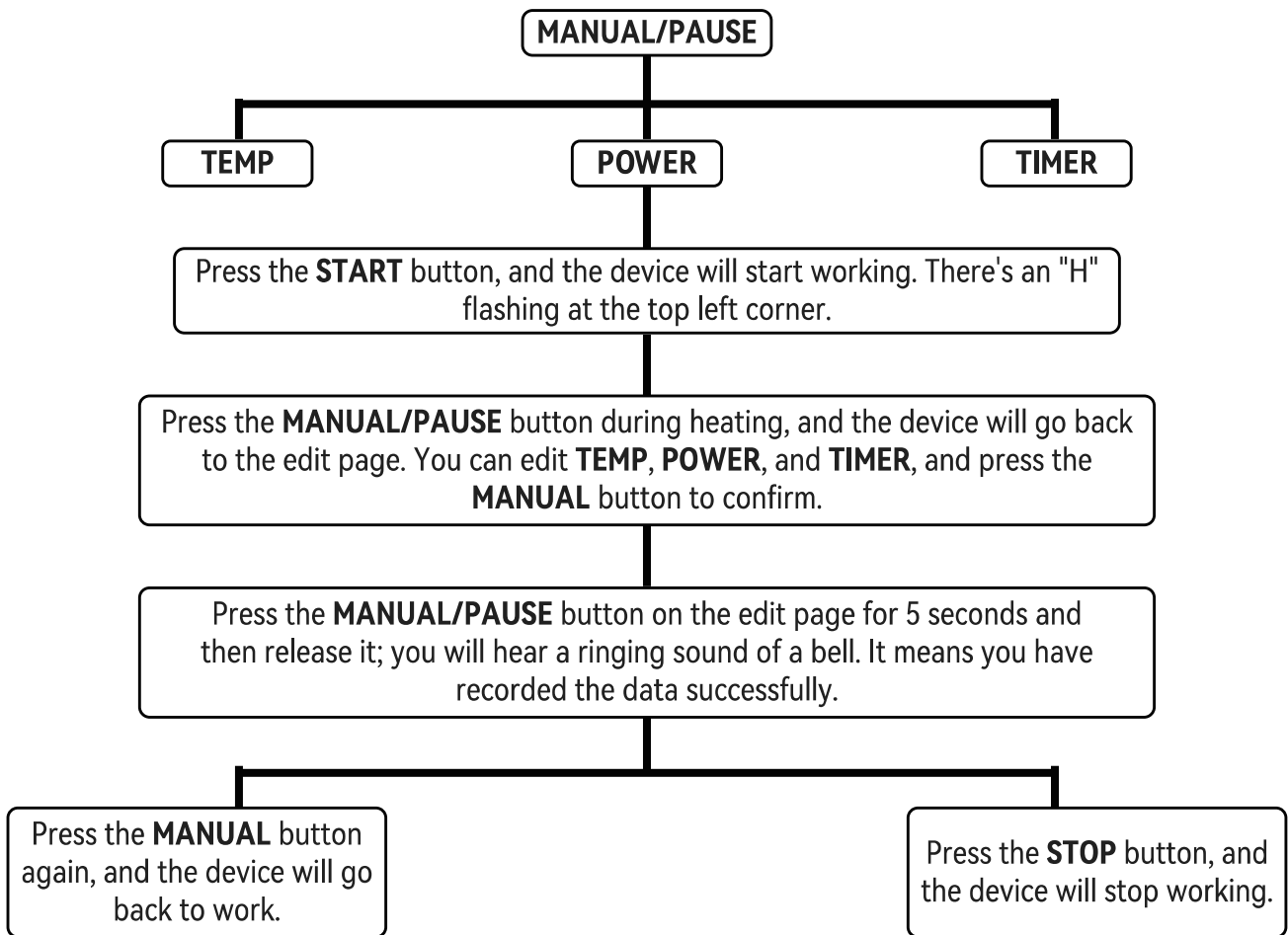

Auto Mode Setting

1. Switch on the device, then press the **AUTO** button.
2. S1 will be shown on the top left corner. Input the 3 settings - **TEMP**, **TIMER**, and **POWER** as above.
3. After setting the 1st program, press the **AUTO** button again to enter the 2nd program setting. The 3rd to 9th programs are set as the 1st and 2nd.
4. When you have entered up to 9 steps as required, press the **START** button to confirm the above step mashing settings.
5. The step after boiling will be skipped if 9 steps are too much for you. This program only supports one boiling setting in each recipe. You can adjust the boiling power during operation anytime.
6. **When S1 is finished, there is a reminder ringing. The program will not enter the 2nd step unless you press the AUTO button to confirm. It is an ingredients-filling reminder.**
7. **The boiling reminder is the same as above. When the device finishes the step before boiling, a reminder rings. The program will not enter boiling step unless you press the AUTO button for confirmation. It is a sparing reminder.**
8. The **PAUSE** button will stop the element and timer from working temporarily, and you can amend the data afterward. Press the **AUTO** button to continue.
9. Press the **START** button when auto mode is running, then you can skip the step you do not need instantly.

10. **Setting hop reminder in boiling process, press "-" or "+"** for countdown timer setting. Press the **TIMER** button for the 2nd, 3rd...9th settings. The countdown timer must be **boiling leads time>1st >2nd>3rd...>9th**. Press the **START** button to start to heat.

11. Long-press the **POWER** and **TIMER** buttons for 5 seconds in the **BLANK PAGE**, the operation will enter recipe selection. Press "-" or "+" to choose the required recipe. Recipe storage is up to 9 programs. Press the **START** button to confirm the selected recipe, and the **BLANK PAGE** will be shown on display. Then, press the **AUTO/PAUSE** button to enter the chosen recipe edit page. You can press the **START** button to run the picked-up program instantly or press the **AUTO/PAUSE** button to edit or check the program step by step.

12. If you press the **STOP** button to skip all the steps, the device stops working, the display shows **END**, and the bell rings for 30 seconds. Press the **STOP** button again to enter the **BLANK PAGE**.

Memory Function in Auto Mode

1. After setting all the data you need in auto mode, press the **STOP** button to enter **BLANK PAGE**. Please do not switch off the device and follow steps below for recording.

2. Press the **MANUAL** button to enter the manual edit page. Then, long-press the **MANUAL** button for 5 seconds and release it. You can record the last manual and auto mode settings. There is a ringing sound of a bell for a successful recording.

3. Switch off/on the device, then, press the **AUTO** button, the 1st step of the last chosen program will be shown on display.

4. Press the **START** button, and the device start working.

5. Our program does not support batch storage. Each recording needs to repeat the above instruction.

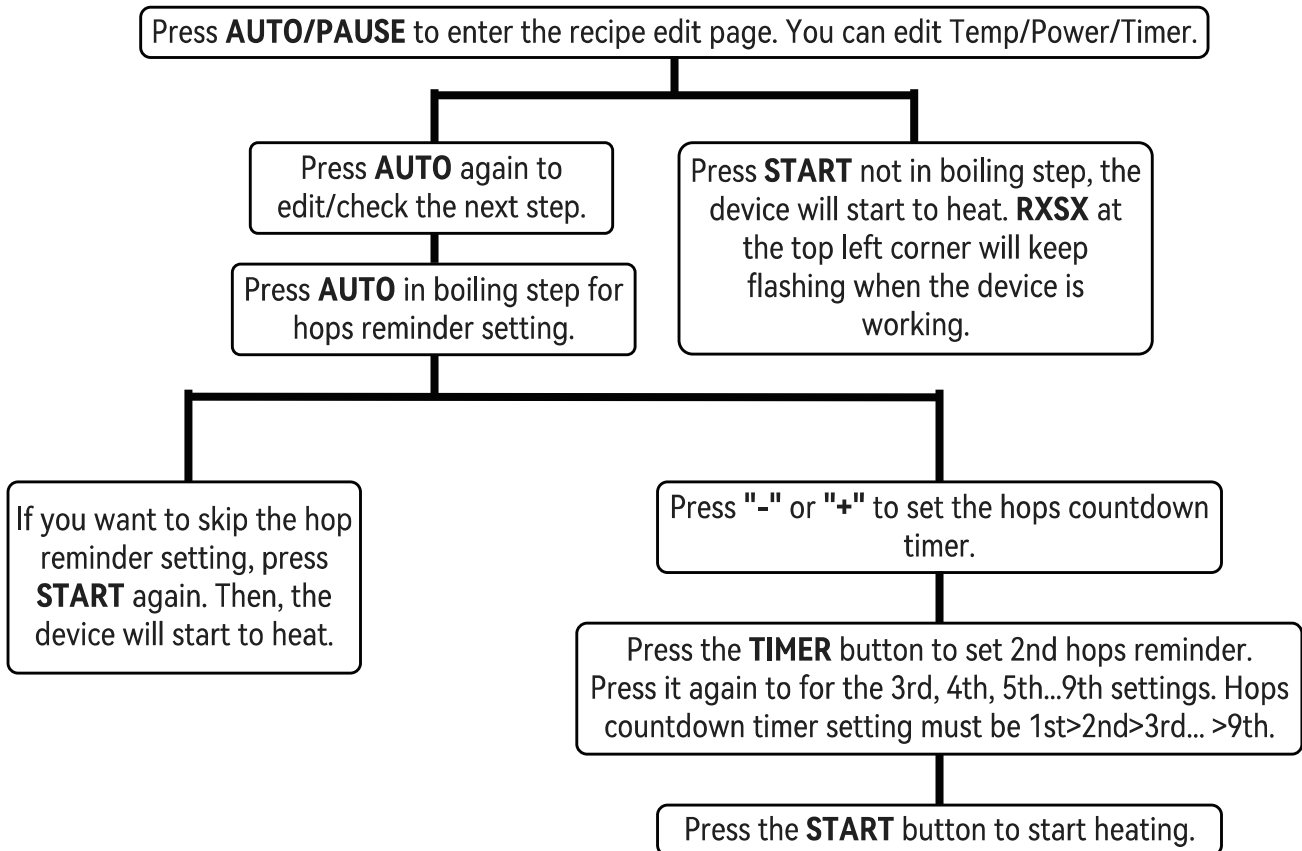

Recipe Selection in Auto Mode

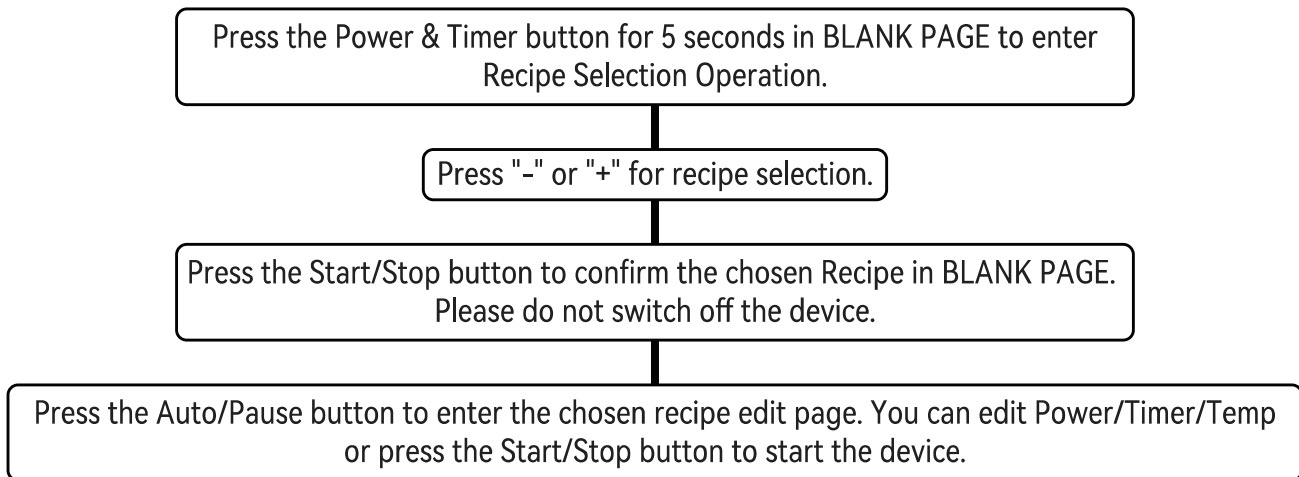

Brewing Preparation

- The device must be positioned on a stable, secure, and horizontal support structure before use.
- A full vessel contains boiling hot liquids and can weigh up to 40kg. 50L up to 50kgs horizontal positioning is a prerequisite for transfer pumping during the brewing process. Avoid an unsteady base.
- The device may not be moved during the brewing process. The handles are only meant for transporting the device in an empty state.
- It is imperative to keep children, frail persons, and animals away from the device while it is in operation. Remember that boiling water is very dangerous.
- Always clean all the parts of your brewing equipment. Hygiene is imperative to get good brewing results.
- Before use, it is acceptable to heat a quantity of hot water in the boiler to sterilize the brewing equipment, etc.
- After grinding the malt, it is recommended to shake it before saccharifying it. Dry burning should be avoided.
- You are now ready to brew!

Brewing Process (Example)

- Always clean the machine before and after use.
- Assemble the Bazooka filter to the tap and add the required quantity of water before switching it on.
- Heat up the water to 66°C-68°C, then add the grain into the grain basket and stir it gently.
- Start your circulation pump when the correct temperature is reached, then regulate the pump flow as shown in the section below.
- The standard heat session time is 60mins for the 1st mashing (recipes may vary).
- The 2nd mashing temperature is 78-80°C, and the session time is 20mins (recipes may vary).
- After mashing, please carefully lift the grain basket with the separate handle, and locate the grain basket lugs onto the support ring on the boiler rim.
- Use your sparging water to extract excess sugars from the grain in the basket. Remember to leave basket to drain into the boiler for about 10mins after sparging.

- Heat up the water to the boiling temperature, which can be done while the basket is draining. The boiling session time is 90mins (recipes may vary).
- Add the hops etc., at the correct timings according to your recipe.
- To sterilize the equipment, immerse your wort chiller about 15mins before the boiling is finished.
- After boiling, cool down the wort to 20°C before transferring it to your fermenting vessel via the drain tap/bazooka filter on the boiler front.

Maintenance

- It is essential to clean the device after use. The dry ingredients may stick onto the metal and inside the pump.
- Rinse the device with 5L-10L 60°C water for 15 mins or more until you make sure it is clean. Please turn on the pump during cleaning.
- Do not use any sharp metal implement to remove the residue. Use a soft cloth or soft scouring pad to clean the inside of the boiler instead. (Vinegar can be good for cleaning.)
- Any wort residue marks on the boiler base should be cleaned off before the next use.
- Flush the pump reversely by connecting a hose to the curved pipe.
- Suitable cleaning products can be used. (Please check their suitability before.)
- Do not splash any electronic parts of the device.
- Do not immerse the machine in the water.
- Store the device in a dry place. Do not plug in when not in use.

Troubleshooting Tips

Ingredients stuck in the pump	A: Flush the pump by connecting a hose to the curve pipe. B: Dismantle the pump to remove the ingredients.
Fail to reach 100°C	A: Put the cover on for 1 to 2 mins. B: Do temperature correction.
C1--Celsius temperature correction	A: Press "-" and "+" simultaneously to enter the C1 temperature correction setting. The setting range is from -10°C to +10°C.
F1--Fahrenheit temperature correction	A: Press "-" and "+" simultaneously to enter the C1 temperature correction setting. The setting range is from -50°F to +50°F.
ERR-1 shown on display	A: A low-temperature warning indicates a lower temperature than -20°C. B: The sensor connector is loosened. C: Open the underneath and check the sensor. Re-connect it if it loosens.
ERR-2 shown on display	A: An overheat/boil-dry warning indicates a higher temperature than 120°C. B: The sensor is fails. Please get in touch with the dealer for replacement.
Suddenly shut off during heating	A: Lower the heat up power. B: Replace the overheat protection thermostat.

Technical Data

Model No.	DM-N30
Volume	30L up to top, 35L to full line
Voltage	European Specification 220V-240V
	American Specification 110V-120V
Power	European Specification 2500W
	American Specification 1800W
Frequency	European Specification 50Hz
	American Specification 60Hz

Electric Circuit

American Specification

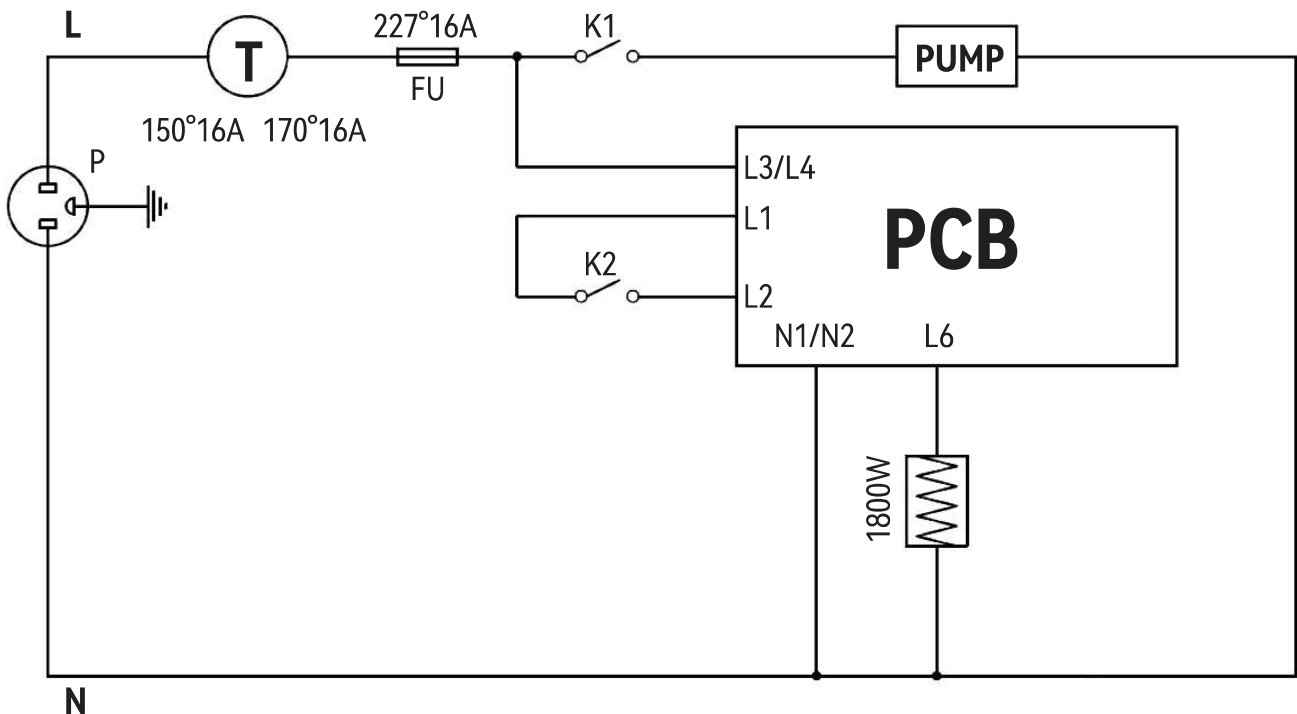

European Specification

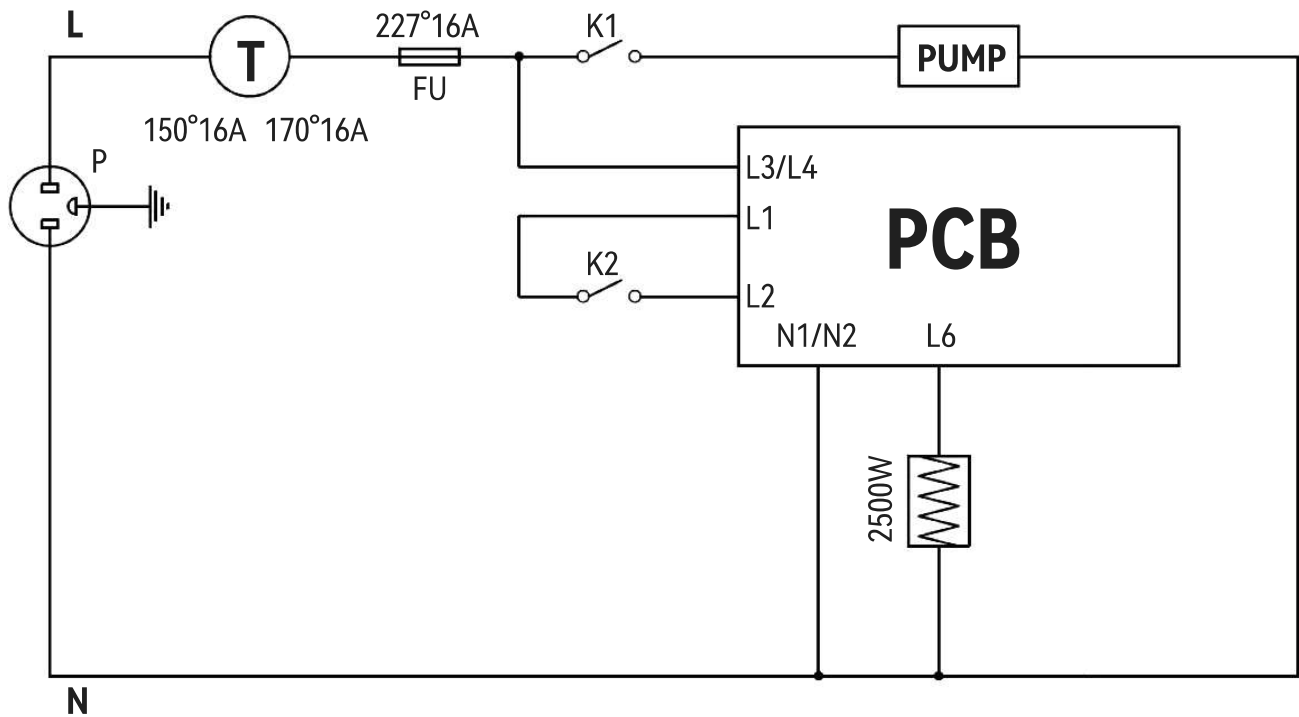

Manufacturer: Foshan Shunde Damai Kitchen Utensils Co.,Ltd

ADD: Ronggui, Shunde, Foshan City, Guangdong Province

EU Importer: WAITCHX

Address: 250 bis boulevard Saint-Germain 75007 Paris

EC	REP	EUREP GmbH Unterlettenweg 1a, 85051 Ingolstadt, Germany
-----------	------------	---

VEVOR[®]

E-mail: CustomerService@vevor.com