

**MODEL:**

SAP24LPG

SAP24NG

# Eztankless



## Tankless Hot Gas Water Heater

Installation and Operation Manual



CSA/ANSI Z21.10.3:19·CSA4.3:19

**WARNING**

If the information in these instructions is not followed exactly, a fire or explosion may result causing property damage, personal injury or death.

— Do not store or use gasoline or other flammable vapors and liquids in the vicinity of this or any other appliance.

— WHAT TO DO IF YOU SMELL GAS

- Do not try to light any appliance.
  - Do not touch any electrical switch; do not use any phone in your building.
  - Immediately call your gas supplier from a neighbor's phone. Follow the gas supplier's instructions.
  - If you cannot reach your gas supplier, call the fire department.
- Installation and service must be performed by a licensed professional.

## CONGRATULATIONS

Congratulations and thank you for choosing our tankless water heater. Before use, please read this manual carefully and thoroughly. Keep this manual for future reference. If you need an additional manual, contact the manufacturer or your local distributor. When you call, please tell us the product name and the serial number of your unit written on the rating plate of the water heater.

# Installation Manual and Owner's Guide

## **WARNING:**

If the information in these instructions is not followed exactly, a fire or explosion may result in property damage, personal injury or death.

- Do not store or use gasoline or other flammable vapors and liquids in the vicinity of this or any other appliance.
- WHAT TO DO IF YOU SMELL GAS
  - Do not try to light any appliance.
  - Do not touch any electrical switch; do not use any phone within your building.
  - Immediately call your gas supplier from a neighbor's phone. Follow the gas supplier's installation.
  - If you cannot reach to your gas supplier, call the fire department.
- Installation and service must be performed by a qualified installer, service agency or the gas supplier.



If you have any questions, please call or write to :  
[support@eztankless.com](mailto:support@eztankless.com)

Tel.: 765-885-5125

Please place this manual in the water heater accessory for reference when maintenance, adjustment or repair is required.



# Contents

## Installation Manual

1. Specification.....	05
2. Introduction.....	06
3. Safety Guide.....	09
3.1 General.....	09
4. Installation Instructions.....	10
4.1 General.....	10
4.2 Water heater installation check list.....	14
4.3 Prepare For Installation.....	15
4.4 Installation Space.....	16
4.5 Installation Warning.....	17
4.6 Typical Installation.....	19
4.7 Exhaust Pipe Specifications.....	20
5. Venting Instructions.....	21
5.1 General.....	21
6. Vent Termination Clearances.....	23
7. Combustion Air Supply.....	25
8. Gas And Gas Pipe Specifications .....	29
8.1 General.....	29
9. Gas Connection.....	30
10. Water Connection.....	31
11. Pressure Reducing Valve.....	32
11.1 Maintenance.....	32
12. Electrical Connections.....	33
13. Initial Test Run.....	34

## Owner's Guide

14. Operational Safety.....	37
15. Operational Instructions.....	39
15.1 Built-in Controller.....	39
15.2 Controller Thermometer....	39
16. Troubleshooting.....	41
17. Maintenance.....	46
18. Antifreeze System.....	47
18.1 Antifreeze Tips.....	47
19. Gas pressure test position.....	48
20. Component Diagram.....	49
21. Wiring Diagram.....	51
22. Packing List.....	52

# Specification Installation Manual

MODEL		SAP24
Natural Gas Input (Operating Range)	Btu/Hr	Min.:17,000 Max.:170,000
Propane Input (Operating Range)	Btu/Hr	Min.:17,000 Max.:170,000
Gas Connection		3/4"NPT
Water Connections		3/4"NPT
Water Pressure*	psi(MPa)	15-150 (0.1-1)
Natural gas Inlet Pressure	"W.C.(kPa)	Min. 3.5 (0.87) Max. 10.5 (2.61)
Propane Inlet Pressure	"W.C.(kPa)	Min. 8.0 (1.99) Max. 13.0 (3.23)
Net weight	lbs (kg)	39.3(17.8)
Dimensions	inch	H26.2xW17.1xD7.3 H665xW435xD186.5

mm

Ignition Electric Ignition

Electric	Supply		VAC / Hz	120 /60
	Consumption	Ratedpower	W /A	43/0.6
		Standby	W /A	2/0.15
		reeze-Protection	W /A	100/0.85

Water heater Category\*\* Category III



**\*15 psi or above is recommended for water maximum flow.**

**\*\*The category of the water heater with respect to the venting system.**

**Water heater Category** – water heaters of other than direct vent type, for outdoor installation, are divided into four categories based on static pressure produced in the vent and flue loss.

**Category I** - a water heater that operates with a non-positive vent static pressure and with a vent gas temperature that avoids excessive condensate production in the vent.

**Category II** - a water heater that operates with a non-positive vent static pressure and with a vent gas temperature that may cause excessive condensate production in the vent.

**Category III** - a water heater that operates with a positive vent static pressure and with a vent gas temperature that avoids excessive condensate production in the vent.

**Category IV** - a water heater that operates with a positive vent static pressure and with a vent gas temperature that may cause excessive condensate production in the vent.

#### **NOTE:**

- Check the rating plate to ensure that this product matches your specifications.
- The manufacturer reserves the right to discontinue, or change at any time, specifications or designs without notice and without incurring obligation.

## **Introduction**

- This manual provides the information you need to install, operate, and maintain your water heater.
- The model description is listed on the nameplate, which is located on the side panel of the water heater.
- Read all installation instructions thoroughly before installing this product.
- If you have any questions or concerns about this device, please consult the manufacturer or its local agent.
- The unit is a boxless gas fast water heater designed to effectively supply hot water continuously during proper installation.
- **This water heater can only be installed indoors for indoor models.**

- The principle of an instant hot gas water heater is simple:

## SAP24:

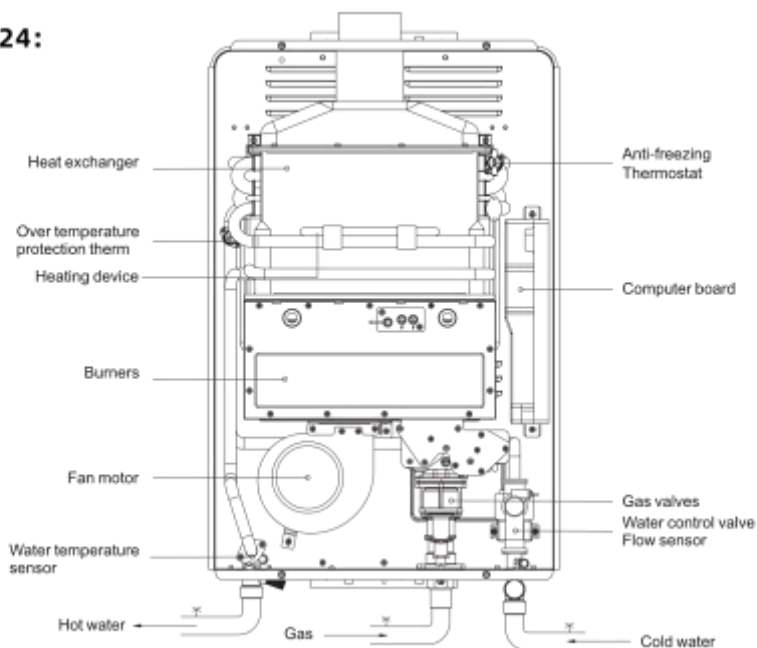

\* This diagram illustrates tankless water heater design concepts only and does not accurately represent the water heater's physical description.

1. A hot water tap is turned on.
2. Water enters the heater.
3. The water flow sensor detects the water flow.
4. The computer initiates the fan motor and sends a signal to the igniter to create an ignition spark.
5. The gas ignites and flames appear within the burner chamber.
6. Water circulates through the heat exchanger and then gets hot.
7. Using thermistors to measure temperatures throughout the water heater, the computer modulates the gas and water valves to ensure proper output water temperature.
8. When the tap is turned off, the unit shuts down.

**This series of gas water heaters with solar linkage function by default:**

- a. When it is detected that the inlet water temperature reaches a predetermined value, the water heater does not start;
- b. When the combustion work is started, and the inlet water temperature is less than the set temperature by 4 °F (2 °C), the water heater stops working;
- c. When the combustion work is started, if the inlet water temperature is  $\geq 140$  °F (60 °C), the water heater stops working.

Controller temperature adjustment range (°F)	System start condition		Normal combustion conditions	
	Inlet water temperature (°F)	Set temperature - inlet water temperature (°F)	Inlet water temperature (°F)	Set temperature - inlet water temperature (°F)
95~149 (35 °C ~ 65 °C)	< 113 (45 °C)	$\geq 7$ (4 °C)	< 140 (60 °C)	> 4 (2 °C)

# Safety Guide

## Safety Definition

### DANGER

Indicates an imminently hazardous situation which, if not avoided, will result in death or serious injury.

### WARNING

Indicates an imminently hazardous situation which, if not avoided, could result in death or serious injury.

### CAUTION

Indicates an imminently hazardous situation which, if not avoided, could result in minor or moderate injury.

### NOTICE

Indicates information considered important but not hazard related.

## General

1. Follow all local regulations, or in the absence of local regulations, follow the current version of the US National Gas Code: **US ANSI Z223.1/NFPA 54**, and/or **CSA B149.1**, Natural Gas and Propane Installation.
2. Ground the equipment properly in accordance with all local regulations or without local regulations, using the National Electrical Code: **ANSI / NFPA 70** or **Canadian CSA standard C 22.1** Canadian Electrical Code Part 1.
3. Carefully plan where you plan to install the water heater. **please ensure: Your water heater will have enough flammable air and proper ventilation.** Install the water heater in a location where water leaks do not damage the surrounding area. (See page 11)
4. **Check the gas type, gas pressure, water pressure and rated current on the nameplate.**

\* If the unit does not meet your requirements, please do not install and consult the manufacturer.

5. If any problems occur, turn off all hot water taps and turn off the gas. Then call a trained technician or gas company or manufacturer.

# Installation Instructions

## General

1. Follow all local regulations, or in the absence of local regulations, follow the current version of the US National Gas Code: **US ansi z 223.1 / nfpa 54** or **Canada b 149.1** natural gas, propane installation specifications.
2. All gas water heaters require proper and careful installation to ensure safe and efficient operation. **This manual must be strictly observed.** Read the "Safety Guide" section.
3. The manifold pressure is preset at the factory. It is computer controlled and does not require adjustment.
4. Maintain proper maintenance space when installing equipment, so that it can be easily connected or removed.
5. The water heater must be installed in a place where it can be used at any time with a suitable amount of combustion air. **The indoor water heater must be vented to the outside.**
6. The electrical connection requires disconnecting the unit for maintenance and safety to turn off the power to the water heater.
7. **Do not install the unit where the exhaust vents point to any openings in the building.** Ensure that the vent terminal meets the required distance from any door or opening by local regulations to prevent exhaust gases from entering the building.
8. **Carefully select the installation location of the water heater.** Lint and fine powder contaminants can block the air intake and reduce fan operation. This in turn, can lead to burning anomalies and shorten the life of the water heater. Regularly ensure that the area around the water heater air inlet are free of dust, debris and other contaminants.
9. **This water heater is for indoor installation only.**
  - The water heater requires a 3-inch exhaust pipe. See the subsequent sections for more details.
  - Only install the water heater in an area where the temperature is not below freezing. **THE WARRANTY DOES NOT COVER DAMAGE CAUSED BY FREEZING.**
  - The water heater must be securely mounted to a wall or other suitable structure.
  - The water heater cannot be installed on the floor.

## WARNING

- Water temperatures above 125 °F (52 °C) can cause severe burns or burns. The factory water temperature is set at 107 °F (42 °C) to minimize the risk of burns. Always check the water temperature before taking a shower or shower.

- Do not store or use gasoline or other flammable materials, vapors or liquids near this equipment.

- Do not connect to water or gas connections as this can damage the valve and can cause serious injury or death.

- Do not use this product if it is immersed in water. Call a qualified installer or service facility immediately to replace the water-immersed water heater. Do not attempt to repair the unit. Must be replaced.

- Do not disconnect the power supply if the ambient temperature is below freezing. The frost protection system is only effective when the device has power. **IF THE HEAT EXCHANGER IS DAMAGED DUE TO FREEZING, IT IS NOT COVERED BY THE WARRANTY.**

- Failure to follow these warnings can result in serious personal injury or death.



## WARNING

- Installation and repair must be performed by a qualified installer (for example, a licensed plumber or gas fitter) or the warranty will be void.
- The installer (authorized professional) is responsible for properly installing the water heater and complying with all national, state/provincial and local regulations.
- The manufacturer does not recommend installing the water heater in a pit or location where gas and water may accumulate.
- Do not point the vent to any operating window, door or opening to the building.
- Do not install any air debris (such as a dryer) that could cause debris to get trapped in the combustion chamber unless the system is directly ventilated.
- Do not install the unit in water, debris or flammable vapors that may enter the flue terminal or intake line.
- Due to safety issues, the manufacturer does not recommend installing the water heater in the attic. Such as if you install the water heater in the attic:
  - Make sure the equipment has adequate combustion air and proper ventilation. Failure to do so may result in carbon monoxide poisoning or death.
  - Keep the area around the water heater clean. When the dust collects on the flame, the sensor will turn off the error code.
  - Place the equipment for easy repair and maintenance.
  - If a leak occurs, it is recommended to install a drain pan or other waterproof protection under the water heater.
  - Failure to follow these warnings can result in serious personal injury, death and/or property damage.

## NOTICE

### **The warranty does not cover damage caused by water quality.**

- This water heater can only use potable water. Do not introduce pool, well or hot spring water or any chemically treated water into the water heater.

- For all other types of applications, the water hardness level for single family applications should not exceed 7 grains per gallon (120 ppm) or 4 grains (70 ppm) per gallon.

The hardness of the water can cause scaling and can affect/damage the water heater. Hard scale must be avoided or controlled by proper water treatment.

- The PH of the water must be between 6.5 and 8.5.

- When the water heater is installed in a beauty salon, dry cleaner or NOTICEhe location where there is such a chemical in the air. Whenever any other location, the manufacturer recommends direct venting.

Certain chemicals used in beauty salons or dry cleaners may affect the flame sensor. In this case underneath, the water heater may not work properly.

- Although the water heater is designed to operate with minimal sound, the manufacturer does not recommend installing the unit on a wall close to the bedroom or in a room for quiet study or meditation.

- As with any water heating device, there is possibility of leakage at certain times during the life of the product. The manufacturer is not responsible for any water damage that may occur. If you install a drain pan under the unit, make sure it does not restrict the flow of combustion air.



## Water heater installation check list:

- Unbox and check whether the water heater, installation manual and owner's guide, parts and accessories bag, are coming in the box.
- Check to ensure there are no corrosive chemicals in the air intake.
- Water supply should be free of chemicals, and water hardness that higher than allowed level may damage the water heater.
- Ensure there is enough space required for installation.
- Ensure there is enough distance required between the exhaust vent and air inlet of houses.
- Ensure you are using the right exhaust vent products, and follow the installation manual from the suppliers.
- For indoor water heater models, ensure the number of elbows used does not exceed the maximum quantity allowed, and the exhaust vent pipe's total length (including the elbows, each is equivalent to 6 feet) does not exceed the maximum length allowed for the water heater.
- For indoor water heater models, ensure the exhaust vent pipe is outward and downward the slope of 3 degrees.
- Turn off hot water switch, turn on cold water switch and the drain screw, flush the debris and air out of the water pipes. Debris inside the water may damage the water heater. Please use buckets or extra water pipes if needed.
- Ensure no water leakages.
- Turn off cold and hot water switches before cleaning up water inlet filter. Put a bucket under the water heater's filter to catch any water out of the water heater. Screw out the water inlet filter, wash off debris and dusts, and then hand screw the filter back in. When it's done, turn on the cold and hot water switches.
- Ensure the pressure relieve valve's relieving capacity exceeds that of the water heater Btu input rating. Please refer to the specifications on the side of machine for Btu input ratings.
- Install a manual gas shut-off valve between the water heater and your gas supply line.
- Check to confirm there is no gas leakage in piping and fittings.
- Confirm the gas inlet pressure in the min-max range as required.
- Confirm you are using the gas type as required by the water heater.
- Confirm the power supply is 120 V/60 Hz, and properly grounded.
- Confirm the thermostat works normally.
- Connect a gas manometer to the pressure port to verify the system is working normally. Turn on appliances that use high flow rate hot water and set the water heater to its maximum operation capacity, the inlet gas pressure must be higher than the minimum pressure on the specification label.
- Do not induct poisonous chemicals into drinking water, like the chemicals used to process broiler water.
- Drain the water out of the water heater if you are not using the water heater for a significant time period.

# Prepare for installation

## Parts included



Tankless  
Water Heater



User's Manual



Assembly Kit



Warranty



Service Card



Perforated Paper

## Tools needed (Not included)



Screw Driver



Pipe Wrench



Wrench



Gloves



Safety Glasses



Levelling  
Instrument



Hammer Drill  
With Concrete Bits



Soapy Water



Gas Leak Detector



Ruler

## Materials needed (Not included)



Teflon Tape



Approved Venting



Pressure Relief Valve

## Materials that may be needed (Not included)



NPT3/4-in x 1/2-in dia  
Threaded Male Adapter



1/2"Hex Nipple



Threaded Tee Fitting  
(Middle 3/4")



Hot Water  
Isolation Valve



Cold Water  
Isolation Valve



Single gang  
electrical box



Electrical  
Adhesive Tape



Pipe Wrap  
Insulation



Thermostatic  
Mixing Valve

## Installation space

### **⚠ WARNING**

Keep all space clear around the water heater. Failure to do so may cause fire, death, personal injury or property loss.

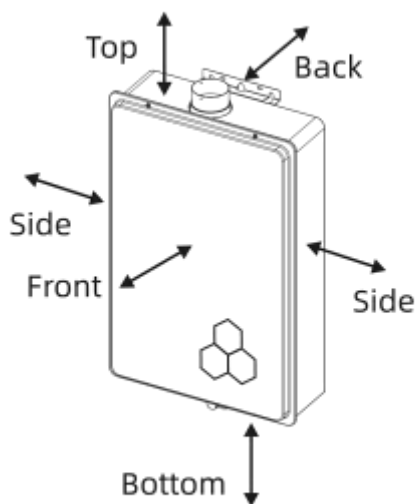

Minimum clearances from combustible or noncombustible construction and for servicing and proper operation:

Top	Bottom	Front	Back	Sides
12" (305 mm)	12" (305 mm)	24" (610 mm)	0" (0 mm)	6" (150 mm)

## Installation Warning

**NOTICE** For your safety, please read before installation.

Before installing the water heater, please contact your local gas supplier or gas management department to select qualified gas pipes, pressure regulators, cylinders, clamps, exhaust pipes, etc., Installator must be entrusted to qualified professional technicians or workers (please do not to install by yourself, for improper installation may cause security issues, and even endanger the user's life). Before installation, please reconfirm whether the type of gas you use is the same as the gas specified on the nameplate of the water heater.

The water heater is a forced-discharge type water heater, and the exhaust gas produced by the water heater must be discharged to the outdoor atmosphere in strict accordance with the requirements. It is strictly forbidden to use this water heater without properly installing the exhaust pipe according to the requirements of this instruction.

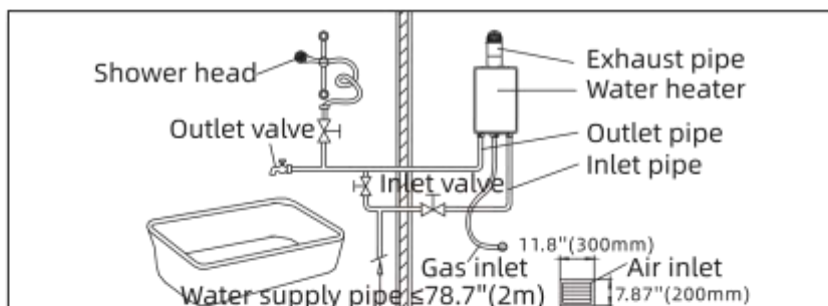

1. Do not install in a place where strong wind can blow, otherwise the flame of the water heater will be extinguished or incomplete combustion will occur.
2. The water heater is forbidden to be installed outside the house, to avoid wind, sun and freezing of the water heater.
3. The water heater inlet must be connected to the outside, with exhaust pipe installed.

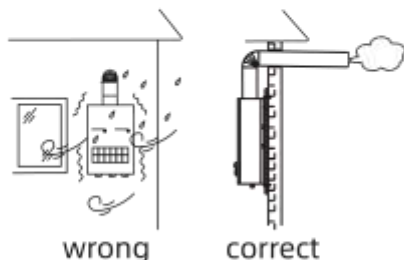

4. It is strictly forbidden to install in the closet.

5. Do not install near flammable materials (such as curtains, gasoline/organic solvents, etc.) and corrosive chemicals (such as alcohol) to avoid fire or corrosion.

6. Do not install the water heater on the vehicle or on the vessel.

7. There shall be no power line, electrical equipment or gas pipeline above the installation position of the water heater. The horizontal distance between the water heater and the electrical equipment shall be greater than **15.7" (400 mm)**; gas appliances such as gas ovens and gas stoves shall not be provided below; and shall not be close to the induction cooker or microwave oven.

Such as strong electric radiation appliances.

8. Install the water heater to the surrounding walls and ceilings at a distance of **5.9" (150 mm)** or more. The installation location should be no. For the construction of combustible materials, if the installation site is flammable or flame retardant, it should be separated by heat-proofplate. The distance between the heat-proofplate and the wall should be greater than **0.39" (10 mm)**.

9. The inlet valve should be installed at the inlet of the water heater; a gas shut-off valve should be installed at the inlet of the water heater.

10. The outlet of the exhaust pipe must be outside the house.

11. Users of propane gas should use qualified gas pressure reducing valves and hoses to ensure the normal operation and safe use of the water heater. Users who use piped gas must ask the gas company or the corresponding management department to connect the gas pipe.

12. The power socket must be grounded reliably. Otherwise, the water heater should be grounded reliably.

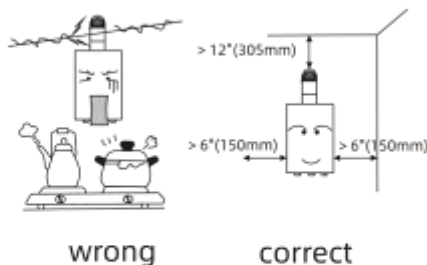
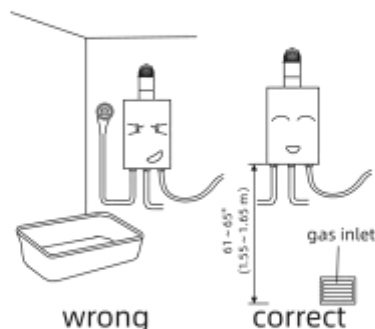

## Typical Installation

1. Determine the installation location (see installation precautions) and determine the installation height. The height of the water heater's operation display panel and the human eye level are appropriate.

2. When installing the water heater, keep it vertical and do not tilt.

3. As shown on the right, first install the mounting hole on the wall. The upper mounting hole is fixed by the expansion screw, and the lower mounting hole is inserted into the plastic plug. Hang the water heater, place the washer and nut on top, and tighten the nut. Screw on the self-tapping screws below.

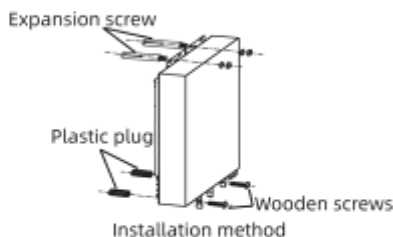

### Precautions for installation of exhaust pipe:

1. The exhaust pipe must be installed when the water heater is used.

2. The elbow and the straight pipe are combined into a smoke exhaust pipe. One elbow is equivalent to 6 ft (1.8 m). But the total length of elbows and straight pipe must not exceed 37 ft (11.5 m).

3. The installation of gas water heater pipe should be outward and downward the slope of  $3^\circ$  is such that when the outdoor temperature is too low, the condensed water does not flow back into the interior of the water heater.

4. When the flue passes through a wall made of combustible materials, it must be covered with an insulating flame retardant material greater than 1 inch thick.

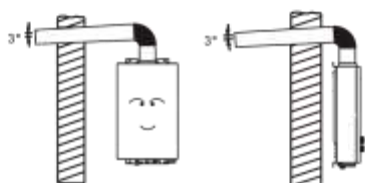

The flue duct should have a slope of  $3^\circ$  outward and downward

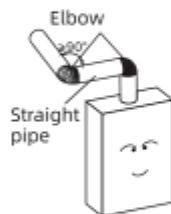

The total length of elbows and straight pipe must not exceed 37 ft ( 11.5 m ).

5. The flue should not be hidden in the ceiling as much as possible. If it is unavoidable, it needs to be wrapped with flame-retardant insulation material, covering a thickness of 1 inch or more. The distance from the flue to the combustible item should be greater than 1 ft.

6. The gap between the flue and the round hole in the wall through which it passes cannot be permanently filled with cement to facilitate maintenance.

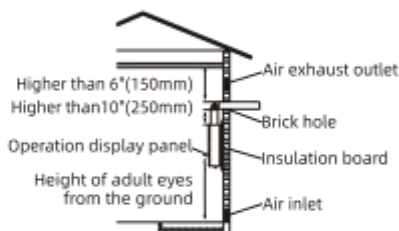

7. The exhaust vents shall not be installed in the ventilation of the building and on the common flue.

## ⚠ WARNING

It is absolutely forbidden to use this water heater without installing a smoke exhaust pipe.

## Exhaust Pipe Specifications

- The maximum length of exhaust vent piping must not exceed **37 ft (11.5m)** for **3" (76.2 mm)** venting, which depends on the elevation where the water heater is installed, Do not use more than **4** elbows. See the table below.
- When the horizontal vent run exceeds **5 ft (1.5 m)**, support the vent run at **3 ft (0.9 m)** intervals with overhead hangers.

Diameter	Max. No. of Elbows (Number of 90° Elbows)	Max. Vertical and Horizontal (Total) Vent Length
3 in (76 mm)	4	37 ft (11.5 m)

\*For each elbow added, deduct 6 ft (about 1.8 m) from max. vent length.

No. of Elbows (Number of 90° Elbows)	Max. Vertical or Horizontal (Total) Vent Length
	3" (76.2 mm) Straight tube length Altitudes 0 to 3,000 ft (0 to 914 m)
0	37 ft (11.5 m)
1	31 ft (9.7 m)
2	25 ft (7.9 m)
3	19 ft (6.1 m)
4	13 ft (4.3 m)

\* Length include vent terminators, termination elbows, or rain caps.

\* Horizontal vent terminators: The water heater shall use 3" zv termination house with damper, part: 2svshtd vent terminators produced by Z-flex US Inc.

\* Minimum clearance from Type B flue or vent connector to combustible construction, 1 inch. Type B Vent or Vent connector shall be used.

## Venting Instructions

### General



- Improper installation of ventilation on this equipment can result in excessive carbon levels and carbon monoxide can cause severe personal injury or death.
- Improper installation can result in nausea or suffocation, serious injury or death from carbon monoxide and smoke poisoning.
- Improper installation will void the product warranty.

Indoor models must be vented according to the current version of the National Gas Code "Equipment Exhaust" section: **US ANSI z 223.1 / NFPA 54 and/ or B 149.1 natural gas section 8 Canadian propane** and propane installation specifications, and applicable local building codes.



## General rules for venting water heaters:

- Place the water heater as close as possible to the vent termination.
- Exhaust pipe must be flexible enough to be removed from the top of the water heater, for proper service and inspection.
- Avoid using oversized exhaust pipes or using extremely long pipes unless it is part of an approved general exhaust system.
- For roof ventilation, a rain cap or other form of terminal must be installed to prevent rain from entering interior.
- A water heater shall not be connected to a chimney flue serving a separate appliance, designed to burn solid fuel.
- **Provisions for adequate combustion and ventilation air in accordance with one of the following:**
  - A) the National Fuel Gas Code, ANSI Z223.1/NFPA 54;
  - B) CSA B149.1, Natural Gas and Propane Installation Code;
  - C) applicable provisions of the local building code.
- **Minimum clearances from combustible or noncombustible construction should be 6 inches sides, 0 inch back, and 12 inches top.** Minimum clearance from Type B flue or vent connector to combustible construction 1 inch. Type B Vent or Vent connector shall be used.
- **When the appliance is installed directly on carpeting,** an isolating metal or wood panel that is 3 inches (at least) exceeding each side length should be placed under. **When the appliance is installed into an alcove or closet,** a panel should be place to cover the entire floor, which is strong enough to carry appliance weight while operating.

## General rules for the termination of vents:

- The water heater should not be connected to the chimney flue of a separate unit used to burn solid fuel.
- Avoid placing the water heater exhaust terminal near any indoor air intake, for the fans discharging flue remains and smoke, or else the remains would return into the building which is harmful to health.
- Locate the exhaust terminal so that will not be blocked by any debris at all times. Most specifications require the terminal to be at least 12 inches (305 mm) above grade and the expected snow level, but the installer can determine if it should be higher based on job site conditions and applicable specifications.



CAUTION

Label all wires prior to disconnection during service or maintenance. Wiring errors can cause improper and dangerous operation.  
Verify proper operation after maintenance.

# Vent Termination Clearances

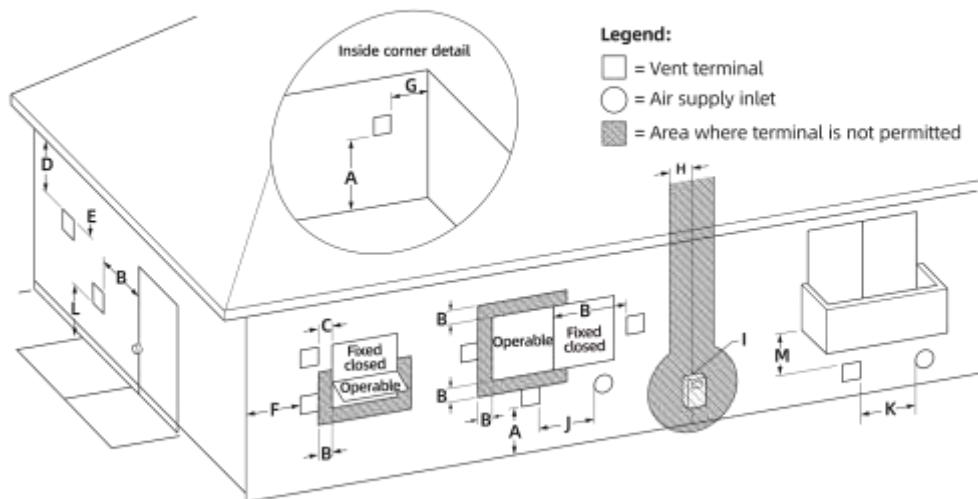

		Canadian installations <sup>1</sup>	US installations <sup>2</sup>
A =	Clearance above grade, veranda, porch, deck, or balcony	12 in (30 cm)	12 in (30 cm)
B =	Clearance to window or door that may be opened	6 in (15 cm) for appliances ≤ 10,000 Btuh (3 kW), 12 in (30 cm) for appliances > 10,000 Btuh (3 kW) and ≤ 100,000 Btuh (30 kW), 36 in (91 cm) for appliances >100,000 Btuh (30 kW)	4 ft (1.2 m) below or to side of opening; 1 ft (300 mm) above opening
C =	Clearance to permanently closed window	*	*
D =	Vertical clearance to ventilated soffit located above the terminal within a horizontal distance of 2 ft (61 cm) from the center line of the terminal	*	*
E =	Clearance to unventilated soffit	*	*
F =	Clearance to outside corner	*	*
G =	Clearance to inside corner	*	*
H =	Clearance to each side of center line extended above meter/regulator assembly	*	*

		Canadian installations <sup>1</sup>	US installations <sup>2</sup>
I =	Clearance to service regulator vent outlet	Above a regulator within 3 ft (91 cm) horizontally of the vertical center line of the regulator vent outlet to a maximum vertical distance of 15 ft (4.5 m)	*
J =	Clearance to nonmechanical air supply inlet to building or the combustion air inlet to any other appliance	6 in (15 cm) for appliances ≤ 10,000 Btuh (3 kW), 12 in (30 cm) for appliances >10,000 Btuh (3 kW) and ≤ 100,000 Btuh (30 kW), 36 in (91 cm) for appliances >100,000 Btuh (30 kW)	4 ft (1.2 m) below or to side of opening; 1 ft (300 mm) above opening
K =	Clearance to a mechanical air supply inlet	6 ft (1.83 m)	3 ft (91 cm) above if within 10 ft (3 m) horizontally
L =	Clearance above paved sidewalk or paved driveway located on public property	7 ft (2.13 m)†	7 ft (2.13 m)
M =	Clearance under veranda, porch deck, or balcony	12 in (30 cm)‡	*

\* For clearances not specified in **ANSI Z223.1/NFPA 54** or **CSA B149.1**, one of the following shall be indicated:

- i) The minimum distance from adjacent public walkways, adjacent buildings, openable windows, and building openings shall not be less than those values specified in the National Fuel Gas Code, **ANSI Z223.1/NFPA 54**, and/or the Natural Gas and Propane Installation Code, **CSA B149.1**;
  - ii) Information on preventing blockage by snow;
  - iii) Information on protecting building materials from degradation by flue gases.
- † A vent shall not terminate directly above a sidewalk or paved driveway that is located between two single family dwellings and serves both dwellings.
- ‡ Permitted only if veranda, porch, deck, or balcony is fully open on a minimum of two sides beneath the floor.

### Notes:

- 1) In accordance with the current **CSA B149.1**, Natural Gas and Propane Installation Code.
- 2) In accordance with the current **ANSI Z223.1/NFPA 54**, National Fuel Gas Code.
- 3) If locally adopted installation codes specify clearances different than those illustrated, then the most stringent clearance shall prevail.
- 4) For other than a direct vent appliance, the appliance must be located as close as practicable to a chimney or gas vent.
- 5) The appliance should be located in an area where leakage of the tank or connections will not result in damage to the area adjacent to the appliance or to lower floors of the structure. When such locations cannot be avoided, it is recommended that a suitable drain pan, adequately drained, be installed under the appliance. The pan must not restrict combustion air flow.

## Combustion Air Supply

### ⚠ WARNING

The gas water heater requires a sufficient source of clean air for combustion and ventilation. Without enough air, your water heater may not function properly and may cause excessive and abnormal carbon monoxide causing poisoning or death.

### NOTICE

- The guidelines in this section apply to installations within the United States. All U.S. installations must conform to the National Fuel Gas Code, ANSI Z223.1/NFPA 54 (current edition) and local codes.
- Canadian requirements differ from the guidelines in this section. In Canada, follow the requirements of B149.1 (Natural Gas and Propane Installation Code, current edition) as well as local and provincial codes. Contact your local code enforcement agency for direction.

Before installing the water heater, you must be sure to supply the required amount of air to the water heater and any other gas equipment in the same area and provide adequate air for combustion and ventilation. If you are not sure of the correct way to supply air to your water heater, please consult a professional.

**Check chemicals:** The air used for combustion and ventilation must be clean and free of corrosive chemicals. If corrosive chemicals such as sulphur, fluorine or chlorine are present, the water heater must be vented directly. Failures due to these corrosive chemicals are not covered by the warranty.

**WARNING!** In all cases, ensure that there are no corrosive chemicals in the air intake. The presence of such chemicals at the air inlet can result in death, personal injury or property damage. **Examples of locations where external air is required due to chemicals include:**

- Beauty salon
- Photo Processing Lab
- Indoor swimming pool
- Laundry, hobby or craft room
- **Chemical storage is not recommended to locate water heaters, such as aerosol sprays, detergents, bleaches, cleaning solvents, gasoline, air fresheners, paint and varnish removers, and refrigerants.**

**All installation is recommended to operate within area with enough combustion air or with fully ventilated with outdoor air.** Be cautious that most modern houses are sealed even with large rooms. For some circumstances when uncertainty about whether ventilation is adequate occurs, contact local gas company for safety checks.

## The instructions below will help determine if the water heater can be installed without outdoor ventilation.

Calculate the total Btu/h rating of all equipment. To calculate the required combustion air and ventilation, add the Btu/h rating of all gas appliances (eg water heaters, furnaces, dryers) in the same area. Do not include appliances that are directly ventilated. See the example below.

The Btu/h rating of your water heater is on the nameplate. The Btu/h rating should be on the rating plate of the other gas appliance. If you are unsure of the Btu/h rating, contact the manufacturer or have qualified personnel to determine the ventilation requirements.

**Note:** If you are replacing an old water heater with a Btu/h rated higher water heater, the amount of ventilation required may be greater.

### Example:

Gas appliance	Btu/h rated
Gas water heater	170,000
Stoves	75,000
Dryer	20,000
Total	265,000

### Your appliance:

Gas appliance	Btu/h rated
Gas water heater	170,000
Total	170,000

Calculating the amount of air in a room The air demand depends on the size of the room.

**Room volume (ft<sup>3</sup>) = floor area (ft<sup>2</sup>) x ceiling height (ft)**

If there are large objects in the room (such as refrigerators, stoves, cars), subtract their volume.

You can better estimate the available air. **Air volume = room capacity - object capacity. Note:** Adjacent rooms with permanently open doorways can be counted as part of the calculation. Calculate the amount of air required to install in an unrestricted attic, with a water heater in the garage or space requiring a space of at least 50 ft<sup>3</sup> (1.42 m<sup>3</sup>) total input of all gas appliances in the same area per 10,000 Btu/h the amount. Required air volume (ft<sup>3</sup>) = total energy level of the equipment (Btu/h) x 50 ft<sup>3</sup> / 1000 (Btu/h) Example:

$(294,000 / 1000) \times 50 = 14,700 \text{ ft}^3$

If the air volume in the room is less than the required air volume, the water heater must be ventilated or lifted directly.

Provide a permanent external air opening to draw in enough air. If you want to provide combustion air for outdoor ventilation, go to "Using Outdoor Ventilation Installation" .

If the amount of indoor air is greater than the amount required, the water heater can be installed without external ventilation.

Otherwise, the water heater may lack oxygen to properly ignite, Negative air pressure may also draw back through the chimney or appliance vents.

Please also mind that: exhaust fans may affect the amount of combustion air available indoor, such as electric appliances like stoves, fans, and dryers.

The solution is to install with enough supplementary vents.

Installation for outdoor ventilation is recommended for most circumstances.

You may need to increase ventilation when lacks adequate ventilation.

Supplying outside air to a water heater typically requires two openings. One opening must be **12 inches (305 mm)** from the floor. The other opening must be **12 inches (305 mm)** from the ceiling. Although a single opening is not preferred, it can be used to introduce outside air when minimum free area is determined (refer to Table 1). When combining air from another room for ventilation, two openings must be applied where air discharges through the crawling space or attic to be fully ventilated.

About pipes, vertical or horizontal pipes are feasible.

**Several options of ventilation are listed below.**

**1. Directly to the outdoors**

**2. Vertical pipe**

**3. Horizontal pipeline**

**4. Single opening (not recommended unless larger than 100 in<sup>2</sup> (6.5 cm<sup>2</sup>).**

Single opening is not applicable to compact spaces less than 50 ft<sup>3</sup> (1.42 m<sup>3</sup>) per 1000 Btu/h or from another room.)

**5. For larger rooms, if necessary, refer to "Calculate the amount of air in the room" above to determine if the total volume of the room is sufficient, while manufacturer does not recommend.**

The minimum individual free zone vent required is sized according to the total Btu/h (Table 1) , rating all appliances within (using the "before" calculation) and the type of vents used.

**Calculating the minimum size of the vents and piping.**

The venting cross-sectional area required to provide a free area depends on the covering on the vent. Typical vents use shutters or grilles to protect the opening. The blinds or grill itself block some free areas, so the openings may need to be larger to meet the minimum free area requirements. Calculate the required cross-sectional area using the following formula: Cross-sectional area = minimum required free area percentage of free area covered (in decimals - Eg, 60 % = 0.6) For example, an opening of 100 in<sup>2</sup> (645 cm<sup>2</sup>) installation area is required if use metal blinds rated at 75% free zone (100in<sup>2</sup> ÷ 0.75 =134 in<sup>2</sup>), then a 134 in<sup>2</sup> (865 cm<sup>2</sup>) opening is required. If you don't know the % available area of the blinds or grill, use the following values:

- For wooden shutters or grilles: **25%**
- For metal shutters or grilles: **75%** follow these rules to ensure that the vents and ducts provide adequate airflow:
- Each vent must be no less than **100 in<sup>2</sup> (645 cm<sup>2</sup>)**.
- The pipe must have the same cross-sectional area as the free area of the opening.
- The minimum size of a rectangular pipe must not be less than **3 inches (76 mm)**.
- All screens must have a grid of **1/4 inch** or larger.
- The removable blinds must be locked open or interconnected to automatically open during operation.
- Keep blinds and grills clean and free of debris or other obstructions. Check that the air source is clean and free of chemicals. The air used for combustion and ventilation must be clean, free from corrosive or flammable chemicals. **Failures caused by corrosive chemicals in the air are not covered by the warranty.** The combustion air must be free of sulfur-containing, acid-containing chemicals such as fluorine and chlorine. Make sure that these chemicals are not in the air at the vents.

# Gas And Gas Pipe Specifications

## General



WARNING

- First check that the gas type matches the nameplate.
- Make sure that all gas regulators in use are operating properly and provide gas pressure within the specified range as shown below. Excessive intake pressure can cause serious accidents.
- Convert this unit from natural gas to propane or vice versa. Contact your local dealer to get the right device for your gas type. The manufacturer is not responsible for any property and/or personal injury caused by gas conversion.
- Failure to follow these warnings can result in serious personal injury, carbon monoxide poisoning or death.

### • Maximum and minimum gas pressure:

Gas type	Intake pressure
Natural Gas	Min. 3.5" W.C. (0.87kPa)-Max. 10.5" W.C.(2.61kPa)
Propane	Min. 8.0" W.C. (1.99kPa)-Max. 13.0" W.C.(3.23kPa)

- Inlet gas pressures outside the above range of values may adversely affect the performance of the water heater. These pressures are measured when the water heater is fully operational.
- The intake pressure must not exceed the above maximum values; gas pressures outside the specified range will result in hazardous operating conditions and equipment damage.
- **Be sure to disconnect the gas line from the water heater before the main gas supply pressure test is completed to avoid damaging the water heater.**
- If the heater's supply pressure is greater than the specified maximum, a pressure regulator is required. The regulator must reduce the gas pressure to within acceptable limits.
- Install the gas regulator according to the manufacturer's instructions.
- **The regulator must be sized for the water heater input and provided with the specified pressure listed on the nameplate.**
- It is recommended that there be at least **3 ft (1 m)** of tubing between the regulator outlet and the water inlet gas connection in the absence of a minimum installation distance.



## Gas Connection

1. Install a manual gas shut-off valve between the water heater and the gas supply line.
2. When the gas connection is completed, the gas leak test must be performed by applying soapy water to all gas fittings and observing the air bubbles or using a gas leak detection device.
  - During any system stress test where the test pressure exceeds  $\frac{1}{2}$  psi (3.5 kPa), it must be the water heater and its separate shut-off valve are disconnected from the air supply piping system.
  - During pressure testing of any gas supply piping system with a test pressure equal to or less than  $\frac{1}{2}$  psi (3.5 kPa), the water heater must be isolated from the air supply piping system by closing its separate manual shut-off valve.
3. Always remove any debris and/or water gas lines before connecting to the air inlet.

### NOTICE

Do not use this product if any parts are underwater. Contact the installer or service agency immediately to replace the flooded water heater. Do not try to repair the heater. Replacement must be done!

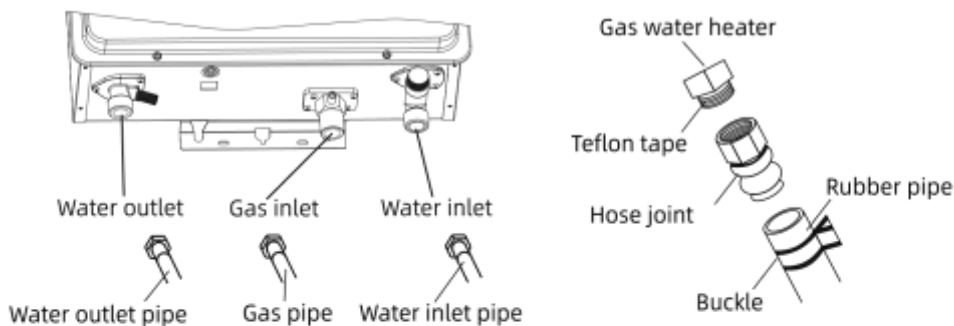

**Note:** Use sealant tape or other approved sealing method on the threads for a secure, no water or gas leakage.

## Water Connection

### **⚠ WARNING**

Do not use this product if any parts are underwater. Contact the installer or service agency immediately to replace the flooded water heater. Do not try to repair the heater. Replacement must be done!

### **NOTICE**

Do not reverse the hot and cold inlet connections of the water heater. If connected in reverse, the water heater will not start properly.

**All piping, fittings, valves and other components, including welding materials, must be suitable for drinking water systems.**

1. The on/off valve must be installed in the cold water inlet of the water heater between the main water supply line and the water heater.
2. Flush the water line to remove any debris before installing the water heater.
3. There is a wire mesh filter in the cold water inlet for filtering debris into the heater. This requires regular cleaning to maintain optimal flow.

## Pressure Reducing Valve

The water heater has a built-in high temperature disconnect switch as a standard safety function (called a Hi-limit switch), so a "pressure only" safety valve is required.

- **The unit is not equipped with an approved pressure reducing valve.**
  - An approved pressure relief valve must be installed at the hot water outlet.
  - The pressure relief valve must comply with **ANSI Z21.22 • CSA 4.4.**
- Installation must comply with local regulations.
- The input capacity of this series of water heaters must be at least 199,000 Btu/h .
  - The pressure relief valve is rated for a **maximum pressure of 150 psi (1 Mpa).**
  - The drain line of the pressure reducing valve must be guided so that hot water does not splash out and cause damage or personal injury.
  - Connect the drain hose to the pressure relief valve so that the end of the tube is **6 inches (152 mm)** from the floor. The tube must be completely drained without any bends or blockages.
  - If the pressure relief valve is periodically discharged, this may be due to thermal expansion in the closed water supply system. Please contact your water supplier or local plumbing professional to find out how to correct this situation. Do not block the pressure relief valve.
  - **The pressure relief valve must be manually operated periodically to check that it is operating correctly.** Before manually operating the valve, check that the pressure relief valve is vented in a safe place.
  - **Do not place a valve between the safety valve and the water heater.**

## Maintenance

- The dirt will directly affect the normal function of the safety valve function. It requires hot water system maintenance of anti-fouling and anti-scaling cleaning.
- **The user must check the relief valve at least once a year.** When checking, turn off the water heater's power supply and gas. Turn on the water inlet switch to create pressure in the water system. The gently open relief valve handle until there is water out and then gently close, if there is no water out, indicating that the valve is invalid, this time should immediately turn off the water heater water switch and ask the service personnel to deal with. Before operating the handle, check the discharge line connecting the valve to ensure that the water drained from the valve can be drained to a suitable place.



**WARNING**

Before manually operating the pressure reducing valve, check that the hot water is discharged in a safe place. If water cannot escape from the end of the drain, turn off the air supply and turn off the power and call a qualified person to determine the cause. See the manufacturer of the pressure relief valve for inspection and maintenance requirements.

- Do not check the safety valve when the water heater is in normal operation to avoid hot water burns.

This is a concept drawing only.

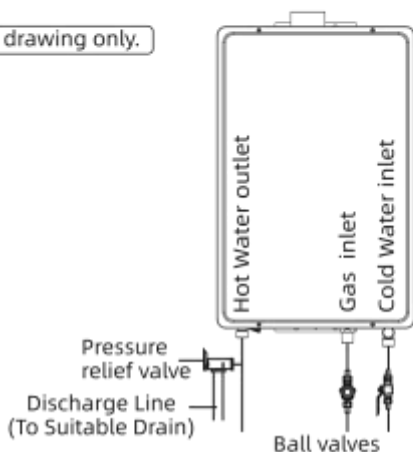

## Electrical Connections



**WARNING**

• Comply with the electrical code requirements of local authorities with jurisdiction. If there is no such requirement, please follow the current version of the National Electrical Code **ANSI/ NFPA 70** or the current Canadian version of **CSA C22.1** Canadian Electrical Code Part 1.

• **When repairing or replacing parts in the water heater**, mark all wires before disconnect to make it easy to reconnect. Incorrect wiring can result in incorrect and dangerous operation. Confirm correct operation after repair.

• Failure to follow these warnings can result in personal injury or death.

1. The water heater must be grounded. Do not connect the ground wire to a gas or water pipe.

2. The water heater requires a 120 VAC, 60 Hz power supply and is properly grounded.

• For maintenance reasons, appropriate disconnects (ie on/off switches,

plugs, etc.) must be provided to control the main power supply to the water heater. (Must comply with local regulations.)

- Connect the power supply to the water heater exactly as shown in the wiring diagram.
3. The plug of the water heater is not plugged into the standard American three-pin plug, and the socket must be properly grounded.
  4. A surge protector is recommended to protect the equipment from power surges.

## For your safety, please read before operation.

- Check for leaks in the gas and water connections for the first time before the ignition.
- Open the main gas supply valve of the unit by hand only to avoid any sparks. Never use tools. If the knob does not turn by hand, do not attempt to force rotation; call a qualified service technician. Forced repairs may result in a fire or explosion due to a gas leak.
- Always check for leaks at the bottom of the unit, as some gases are heavier than air and may settle toward the floor.
- Check gas pressure. See p.21.
- Do not attempt to manually ignite the burner. It is equipped with an electronic ignition device that automatically ignites the burner.
- Check that the water heater is ventilated and that the flammable air is normal.
- Do not use this product if it is in contact with water or immersed in water. Contact a qualified installer or service facility immediately to replace the water heater. Do not attempt to repair the device! It must be replaced!

## Initial Test Run









WARNING

If you smell the gas:

- Do not attempt to start the water heater.
- Do not touch any electric switch.
- Do not use any mobile phones in your building. Call your gas supplier immediately from your neighbor's phone. Follow the instructions of the gas supplier.
- If you are unable to contact your gas supplier, please call the fire department.
- Failure to follow these warnings can result in fire or explosion, resulting in serious injury or death.

The user confirms that the water heater is installed correctly before the initial use, and carefully checks whether the connection is correct and there is no leakage. **After confirming, please follow the steps below:**

### First trial run

1	Turn on the water heater's 120V, 60Hz power supply.	
2	Remove debris from the inlet screen.	
3	Open the valve on the inlet water.	
4	Turn on the hot water tap, make sure there is water flowing out, then turn off the hot water tap.	
5	Open the manual gas valve.	
6	Press the on/off button on the controller and set the desired hot water temperature.	
7	When you turn on the hot water tap, you can enjoy the constantflow of hot water.	

# Owner's Guide

## CONGRATULATIONS

Congratulations and thank you for choosing our tankless water heater. Before use, we recommend that you read through this installation manual carefully. Keep this manual for future reference. If you need an additional manual, contact the manufacturer or your local distributor. When you call, please tell us the product name and the serial number of your unit written on the rating plate of the water heater.

# Operational Safety

## FOR YOUR SAFETY READ BEFORE OPERATING

**WARNING:** If you do not follow these instructions exactly, a fire or explosion may result causing property damage, personal injury or loss of life.

A. This appliance does not have a pilot. It is equipped with an ignition device which automatically lights the burner. Do not try to light the burner by hand.

B. **BEFORE OPERATING** smell all around the appliance area for gas. Be sure to smell next to the floor because some gas is heavier than air and will settle on the floor.

### WHAT TO DO IF YOU SMELL GAS

- Do not try to light any appliance.
- Do not touch any electric switch; do not use any phone in your building.
- Immediately call your gas supplier from a neighbor's phone. Follow the gas supplier's instructions.
- If you cannot reach your gas supplier, call the fire department.

C. Use only your hand to turn the gas shutoff valve. Never use tools. If the valve will not turn by hand, don't try to repair it, call a qualified service technician. Force or attempted repair may result in a fire or explosion.

D. Do not use this appliance if any part has been under water. Immediately contact a qualified installer or service agency to replace a flooded water heater. Do not attempt to repair the unit! It must be replaced!

## OPERATING INSTRUCTIONS

1. STOP! Read the safety information above on this label.
2. Set the thermostat to lowest setting.
3. Turn off all electric power to the appliance.
4. Do not attempt to light the burner by hand.
5. Turn the gas shutoff valve located on the outside of the unit to the closed position.
6. Wait five (5) minutes to clear out any gas. If you then smell gas, STOP! Follow "B" in the safety information above on this label. If you don't smell gas, go to the next step.
7. Turn the gas shutoff valve located on the outside of the unit to the open position.
8. Turn on all electrical power to the appliance.
9. Set thermostat to desired setting.
10. If the appliance will not operate, follow the instructions in "To Turn Off Gas to Appliance" and call your service technician or gas supplier.

## TO TURN OFF GAS TO APPLIANCE

1. Set the thermostat to lowest setting.
2. Turn off all electric power to the appliance if service is to be performed.
3. Turn the gas shutoff valve located on the outside of the unit to the closed position.



It is absolutely forbidden to use this water heater without installing a smoke exhaust pipe.



## ⚠ WARNING

Steam from flammable liquids can explode and catch fire, causing death or severe burns.



Do not use or store flammable products such as benzene, solvents or adhesives in the same room or area near the water heater.

Read and follow the water heater warnings and instructions. If the user manual is missing, contact your retailer or manufacturer.

### Save flammable products:

1. Keep away from the heater.
2. In approved containers.
3. Closed, children are not in contact.
4. The Water heater has a main burner that can be turned on at any time and ignites flammable vapors.

### steam:

1. Can't see.
2. It is heavier than air.
3. Take a long road on the floor.
4. Can be transported from other rooms to the main burner by air flow.

## ⚠ WARNING

1. Water temperature above 125 °F (52 °C) will immediately cause severe burns or scalding.
2. Children, the disabled and the elderly are at the highest risk of being burned.
3. Test the water temperature before bathing or showering.
4. The outlet temperature of the water heater is set to 120 °F (50 °C). If the water temperature you need is lower than this setting, please follow the instruction manual.
5. Use this heater at your own risk. Test the water temperature before showering. Do not leave children or infirm unattended. For available temperature limit valves, please consult your local water supply company pipeline retailer.

Pressure relief valve hot water supply system unit complying with safety valve and automatic shut-off gas standard, **ANSI Z21.22 • CSA 4.4**, should be installed at the manufacturer's designated position during installation. Pressure relief device for safe operation of water heaters. Do not disassemble or block the safety valve. No valves shall be provided between the safety valve and the water heater. The relief valve should be placed in a position where it will not cause damage. Also, no other reducer fittings or other restrictions may be placed on the drain line to limit flow. For installation and maintenance of pressure relief valves, see the installation manual heading "Relief Valves" Valve Discharge Lines and other safety precautions.



# Operation Instructions

## Built-in controller

### FOR YOUR SAFETY

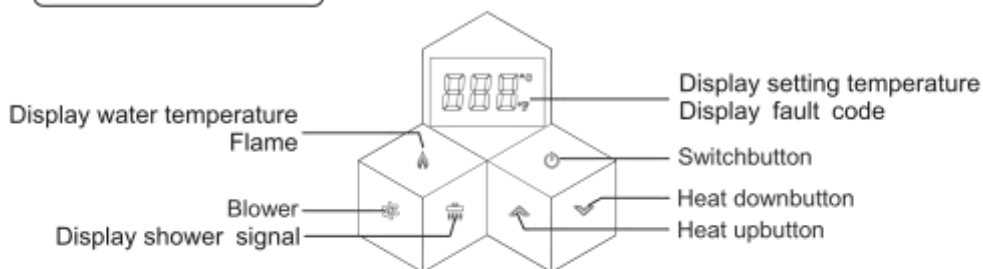
Do not store or use gasoline or other flammable vapors and liquids in the vicinity of this or any other appliance.



1. The unit's outlet water temperature setting range is 95°F ~ 149°F;
2. Press “”, the temperature will increase; Press this button continuously the temperature increase continuously.
3. Press “”, the temperature will decrease. Press this button continuously the temperature will decrease continuously.

## Controller Thermometer

°F	95	96	98	100	102	104	105	107	109
°C	35	36	37	38	39	40	41	42	43
°F	111	113	114	116	118	120	122	123	125
°C	44	45	46	47	48	49	50	51	52
°F	127	129	131	132	134	136	138	140	141
°C	53	54	55	56	57	58	59	60	61
°F	143	145	147	149					
°C	62	63	64	65					

\*Factory setting (default): 107°F (42°C)

## How to use the mixing valve:

1. Turn on the cold water tap.



2. Mix hot and cold water to get the proper water temperature.



3. When the use is over, close the water valve.



**WARNING**

Minors are not allowed to operate the water heater themselves unless accompanied by a guardian.

- If the temperature is set too high, it may cause hot water burns.
- If overheating occurs or the gas supply cannot be turned off, turn off the manual switch gas control valve to the unit.



**WARNING**

Temperatures above 125°F (52°C) can cause severe burns or scalding. The risk of injury to children, the disabled and the elderly is high.

°F	120	125	130	135	140	145	150	155
°C	49	52	54	57	60	63	66	68
Time to produce serious burn	More than 5 minu	One and a half to two	About 30 seconds	About 10 seconds	Less than 5 seconds	Less than 3 seconds	About 1.5 seconds	About 1 seconds

# Troubleshooting

Before You Call For Service Troubleshooting Tips Save time and money! Review the charts on the following pages first and you may not need to call for service. This water heater incorporates a variety of shut off devices that prevents the operation of the water heater down if undesirable combustion conditions occur. Such as the presence of a blockage of the combustion air vent insufficient gas or pressure which can impact the safe operation of the water heater. Please contact a Qualified Service Technician if this occurs. When the water heater fails, the display shows the fault code, and the buzzer continuously sends out "B, B, B" alarms. Please follow the table below.

Error Code	Possible Cause	Fault Handling
When the system is turned on or working, the wired controller displays code "E0", and the buzzer alarms the fault.	<ol style="list-style-type: none"><li>1. The outlet water temperature sensor connector is loose or has poor contact.</li><li>2. The outlet water temperature sensor is damaged (open circuit, short circuit or metal parts).</li></ol>	<ol style="list-style-type: none"><li>1. Clamp the outlet water temperature sensor terminal.</li><li>2. Replace the water temperature sensor.</li></ol>

<p>When the system is turned on the working or the working, the displays code "E1" and the buzzer alarms the fault.</p>	<ol style="list-style-type: none"> <li>1. The gas valve is not open.</li> <li>2. The gas supply pressure or gas composition is abnormal, causing accidental flameout.</li> <li>3. The igniter, ignition needle is damaged or the line is faulty.</li> <li>4. Damage to the flame induction needle or wire failure.</li> <li>5. The combustion system (burner, nozzle, air control panel, proportional valve, sectional valve) is damaged, the specifications are inconsistent or the wiring is wrong, resulting in abnormal combustion.</li> <li>6. The control program or parameter settings are incorrect, resulting in unstable combustion.</li> <li>7. The fan speed is abnormal, resulting in unstable combustion.</li> </ol>	<ol style="list-style-type: none"> <li>1. Open the gas valve to ensure that the water heater can get normal gas supply.</li> <li>2. Confirm that the gas type and pressure meet the requirements of the water heater.</li> <li>3. Check if the igniter, ignition pin and circuit are damaged, and replace the damaged parts.</li> <li>4. Check if the flame induction needle is damaged and replace the damaged parts.</li> <li>5. Check if the combustion system is damaged, if the wiring is wrong, and replace the damaged parts.</li> <li>6. Check whether the program and parameters meet the values in the parameter table.</li> <li>7. The wind speed of the fan is abnormal. Check whether the program and parameters meet the values in the parameter table.</li> </ol>
<b>Error Code</b>	<b>Possible Cause</b>	<b>Fault Handling</b>
<p>When the system is turned on, the wired controller displays code "E2" and the buzzer alarms the fault.</p>	<ol style="list-style-type: none"> <li>1. The feedback pin is bent and in contact with other metal parts.</li> <li>2. The feedback pin plug-in terminal is loose and hits the metal part.</li> <li>3. Feedback pin wire is broken.</li> </ol>	<ol style="list-style-type: none"> <li>1. Replace the ignition feedback needle assembly.</li> <li>2. Plug the feedback pin terminal correctly and firmly into the feedback pin.</li> <li>3. Check if the wire is disconnected and replace the wire.</li> </ol>

<p>When the system is turned on working, the wired controller displays code "E3" and the buzzer alarms the fault.</p>	<ol style="list-style-type: none"> <li>1. The thermostat opens or the wire is faulty.</li> <li>2. The gas supply pressure or gas composition does not match, causing abnormal combustion.</li> <li>3. The control program or parameter settings are incorrect, resulting in abnormal requirements combustion.</li> <li>4. The combustion system is damaged or the specifications are inconsistent, resulting in abnormal combustion.</li> </ol>	<ol style="list-style-type: none"> <li>1. Check the temperature controller or circuit and replace the damaged parts.</li> <li>2. Confirm that the gas type and pressure meet the requirements of the water heater.</li> <li>3. Check whether the program and parameters meet the values of the parameter table.</li> <li>4. Check the combustion system for damage and replace damaged parts.</li> </ol>
<p>When the system is turned on working, the wired controller displays code "E4" and the buzzer alarms the fault.</p>	<ol style="list-style-type: none"> <li>1. The inlet water temperature sensor connector is loose or has poor contact.</li> <li>2. The inlet water temperature sensor is damaged (open circuit, short circuit or metal parts).</li> </ol>	<ol style="list-style-type: none"> <li>1. Clamp the water temperature sensor terminal.</li> <li>2. Replace the water temperature sensor.</li> </ol>

Error Code	Possible Cause	Fault Handling
<p>When the system is turned on or working, the wired controller displays code "E5" and the buzzer alarms the fault.</p>	<ol style="list-style-type: none"> <li>1. The fan signal is not detected or the speed is too low in the system startup 5s.</li> <li>2. During operation, the fan speed is not detected for 2s consecutively, or the speed is too low.</li> <li>3. The power supply voltage is too low, causing the fan speed to slow down.</li> </ol>	<ol style="list-style-type: none"> <li>1, 2, the fan assembly, controller damage or line failure, causing the fan not to run or the speed is too low, check the fan, the main controller is damaged, the wiring is damaged, loose, replace the damaged parts.</li> <li>3. Confirm whether the power supply and fan voltage meet the design requirements.</li> </ol>
<p>During the system working process, the wired controller displays code "E6" and the buzzer alarms the fault.</p>	<ol style="list-style-type: none"> <li>1. The gas supply pressure or gas composition does not match, causing abnormal combustion.</li> <li>2. The control program or parameter settings are incorrect, resulting in abnormal combustion.</li> <li>3. The water temperature sensor specifications do not match, the display temperature is much higher than the actual temperature.</li> <li>4. The combustion system is damaged or the specifications are inconsistent, resulting in abnormal combustion.</li> <li>5. The heat exchanger fins of the heat exchanger are poorly welded, and the heat transfer is slow. After the water valve is closed, the water in the tube is continuously heated.</li> </ol>	<ol style="list-style-type: none"> <li>1. Confirm that the gas type and pressure meet the requirements of the water heater.</li> <li>2. Check whether the program and parameters meet the values of the parameter table.</li> <li>3. Test whether the actual water outlet temperature and the wired controller display temperature are close (<math>\pm 3^{\circ}\text{C}</math>), and replace the wrong outlet water temperature sensor.</li> <li>4. Check the combustion system for damage and replace damaged parts.</li> <li>5. Detect if the heat exchanger fins are poorly welded and replace the damaged parts.</li> </ol>

<p>When the system is turned on or working, the wired controller displays "E7" and the buzzer alarms the fault.</p>	<ol style="list-style-type: none"><li>1. The valve connector is loose or has poor contact.</li><li>2. The valve is short-circuited.</li></ol>	<ol style="list-style-type: none"><li>1. Clamp the water temperature sensor terminal.</li><li>2. Check if the valve coil is short circuited and replace the damaged parts.</li></ol>
---	---	--



Error Code	Possible Cause	Fault Handling
<p>When the system is turned on or working, the wired controller displays code "E8" and the buzzer alarms the fault.</p>	<ol style="list-style-type: none"> <li>1. During operation, the fan speed continuously exceeds the set value of 5 s speed.</li> <li>2. The outdoor wind pressure is too high, and the fan speed exceeds the upper limit of the speed.</li> <li>3. A large amount of carbon in the heat exchange fins (when the gas source is used incorrectly), causing blocked, and the fan speed increase exceeds the upper limit of the speed.</li> </ol>	<ol style="list-style-type: none"> <li>1. Check if the exhaust passage is blocked.</li> <li>2. Stop starting, and start after no strong wind in the outdoor.</li> <li>3. Remove the heat exchanger, use a brush to gently clean the carbon on the fins, and ensure that the type and pressure of the gas used subsequently meet the requirements of the water heater.</li> </ol>
<p>During the system working process, the wired controller displays "En" and the buzzer alarms the fault.</p>	<p>In order to prevent oxygen deficiency, some models have timing protection. Please turn off the tap and use it after a while.</p>	<ol style="list-style-type: none"> <li>1. Set the appropriate time according to the usage habits, and the timed shutdown time can be set to 20, 30, 40, 50, 60 minutes.</li> <li>2. It is not necessary to set "OF" to turn off the timing function.</li> </ol>
<p>Fault alarm release and reset method: If the above code appears, please check the waterway, the gas path is normal, press "Switch button" to turn off or turn off the power to restart. The water heater is restored to normal use. If the above operations cannot be resumed, please notify the after-sales service personnel.</p>		

## The following phenomenon is not a malfunction:

Problem	Possible Cause
White smoke at the exhaust	When the outdoor temperature is too low, the discharged smoke encounters outdoor cold air and condenses into a white mist.
Water is not hot	If the water flow is too low, the water will get cold. The minimum water flow rate is required to be 0.55 gallons per minute----SAP24. Make sure the water heater is running smoothly.
The water heater suddenly shuts down	When timing protection is up, the water heater will shut down automatically. Press on the power button to restart the water heater.
Close the hot water valve, but the fan cannot stop immediately	This is a function to delay the fan off, so that the exhaust gas of the water generated by the combustion of the water heater is completely discharged, ensuring user's safety.
After the water heater starts, it does not supply hot water immediately	There is a distance from the water heater to the hot water tap, because there is still cold water in the water pipe, it takes time to drain the cold water. The longer the pipe, the more time it takes to drain the cold water.

After the water heater is powered on, the controller does not respond

There is no power input, please check the circuit.

# Maintenance

It can only be carried out by authorized personnel and cannot be modified privately. For your comfort and safety, **we recommend checking and maintaining the product every month.** Broken turn on the power and allow the unit to cool before performing maintenance. Do not disassemble the air line and safety devices during maintenance. There are some electronic components in this device. Please do not open, avoid using any kind of liquid to clean electronic components.

## • Daily inspection:

1. periodic examination the inlet and venting systems. And clean up in time.
  - Check the intake louvers for dust and debris to avoid clogging.
  - Check the exhaust vents for dust and debris to avoid clogging.
2. Check if the appearance of the device is abnormal.
3. Check the device for abnormal noise during operation.
4. Check for leaks. (soap water can be used to detect leakage)
5. When carbon deposits are found, they should be promptly notified to the after-sales service provider for maintenance. The serviceman will remove the burner with the crater facing down, use a bristled brush to remove the coke, or replace the burner with a new one.

## • Maintenance instructions:

1. Clean the equipment regularly. Do not use chemical lotions and volatile solvents.
2. To ensure better performance, clean the intake blinds and exhaust pipe. This ensures that combustion and ventilation are unhindered.
3. Close the inlet pipe, remove the inlet filter plug, remove the filter, clean and reinstall.
4. Wipe the display with a damp cloth. Do not use gasoline or grease cleaners to avoid shape changes.
  - Keep the equipment area clean and free of flammable materials, gasoline and other flammable vapors and liquids.
  - If the temperature is set too high, it may cause hot water burns.
  - If overheating occurs or the gas supply cannot be turned off, turn off the manual switch gas control valve to the unit.

**Note:** When servicing, mark all wires before disconnecting. Improper wiring can result in improper operation and danger. Check if the operation is normal after maintenance.

## Minimum load adjustment method:

Set the temperature on the controller to 35 °C and increase the inlet water temperature so that the outlet temperature is above 35 °C. It then proves that the water heater is operating at its minimum heat load.

Service Center: [support@eztankless.com](mailto:support@eztankless.com)

Tel.: 765-885-5125

# Antifreeze System

• This water heater is equipped with an automatic electric heating unit for antifreeze.

The specification is 120 V 101w. When the temperature is in the range of 3 °C (37.4 °F)~8°C (46.4 °F), electric heating starts. Make sure the power is on when you need to start heating.

• **If you do not use the heater for a long time:**

1. Disconnect the water heater from the water source and turn off the water and gas.
2. Discharge the water from the water heater completely.  
This will protect your equipment from freezing and damage.

## Antifreeze Tips

• When the temperature is below 8 °C (46.4 °F) while above 3 °C (37.4 °F), keep your water heater staying plugged in a 120V 60Hz power supply, the anti-freeze system will automatically heat up to prevent the water heater from damages. No manual work is needed.

• While if the temperature is below 3 °C (37.4 °F), or the machine is not in use for a considerable time, the water heater must be drained to avoid freezing damages. And here is the process:

- 1) Turn off the gas shut-off valve.
- 2) Power off the water heater and unplug the power supply to the machine.
- 3) Turn off the water supply shut-off valve.
- 4) Turn on hot water taps in the house, to release the water and pressure in the pipes.
- 5) Screw out the drain screw on the hot water outlet.
- 6) Remove the inlet water filter from the cold water inlet and it's valve by turning counterclockwise.
- 7) Use a bucket to collect the residual water while draining. It may take more than 10 minutes to drain out the water thoroughly.
- 8) Securely screw the drain screw back in place; and screw the inlet water filter back in place.
- 9) Before you use the water heater next time, plug it into a 120V 60Hz power supply, and power on the water heater, and then open the water supply valve, hot water outlet valve, and the gas valve.

• Please note damages caused by freezing are NOT covered under the tankless water heater warranty as an industry standard. Please make sure to take all the measures to protect your water heater.

## Gas pressure test position

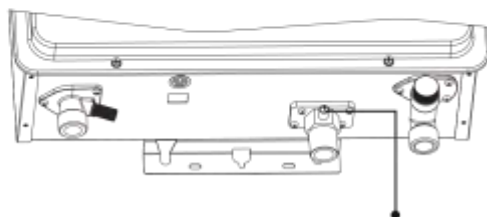

**Pressure measuring nozzle**

- The gas inlet has a pressure measuring nozzle. The inlet gas pressure can be measured by unscrewing the screw.

**Note:** Please close the gas valve before connecting the measuring instrument. Avoid accidents such as fires.

# Component Diagram

Here is the place to replace the spare parts:

**SAP24:**

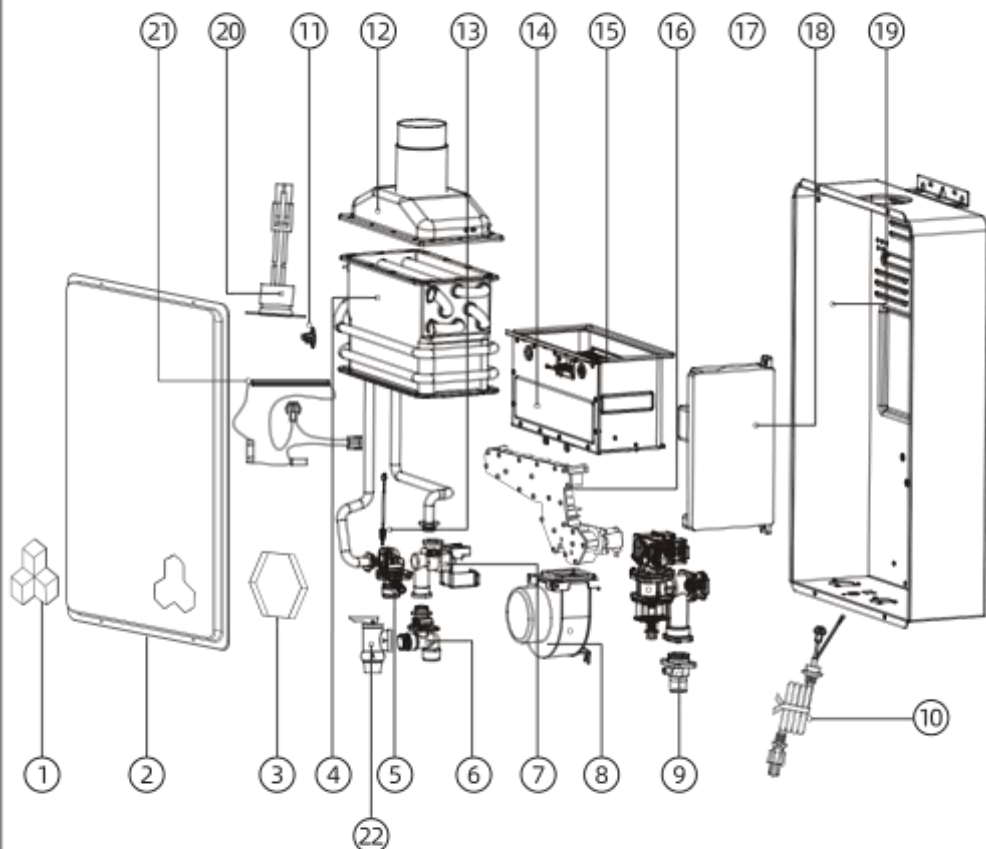

## SAP24

No.	Name	QTY.	Remarks
1	Decoration board	1	
2	Front panel	1	
3	Display assembly	1	
4	Heat exchanger	1	
5	Water outlet connector	1	
6	Water inlet connector	1	
7	Water proportional valve	1	
8	Motor fan assembly	1	
9	Intake connector	1	
10	Power line	1	
11	Over temperature protection thermostat	1	
12	Chimney	1	
13	Water outlet temperature sensor	1	
14	Burner	1	
15	Ignition pin assembly	1	
16	Manifold	1	
17	Proportional valve	1	
18	Controller	1	
19	Back panel	1	
20	Anti-freezing thermostat	1	
21	Heating device	1	
22	Pressure Relief Valves ( for canada )	1	







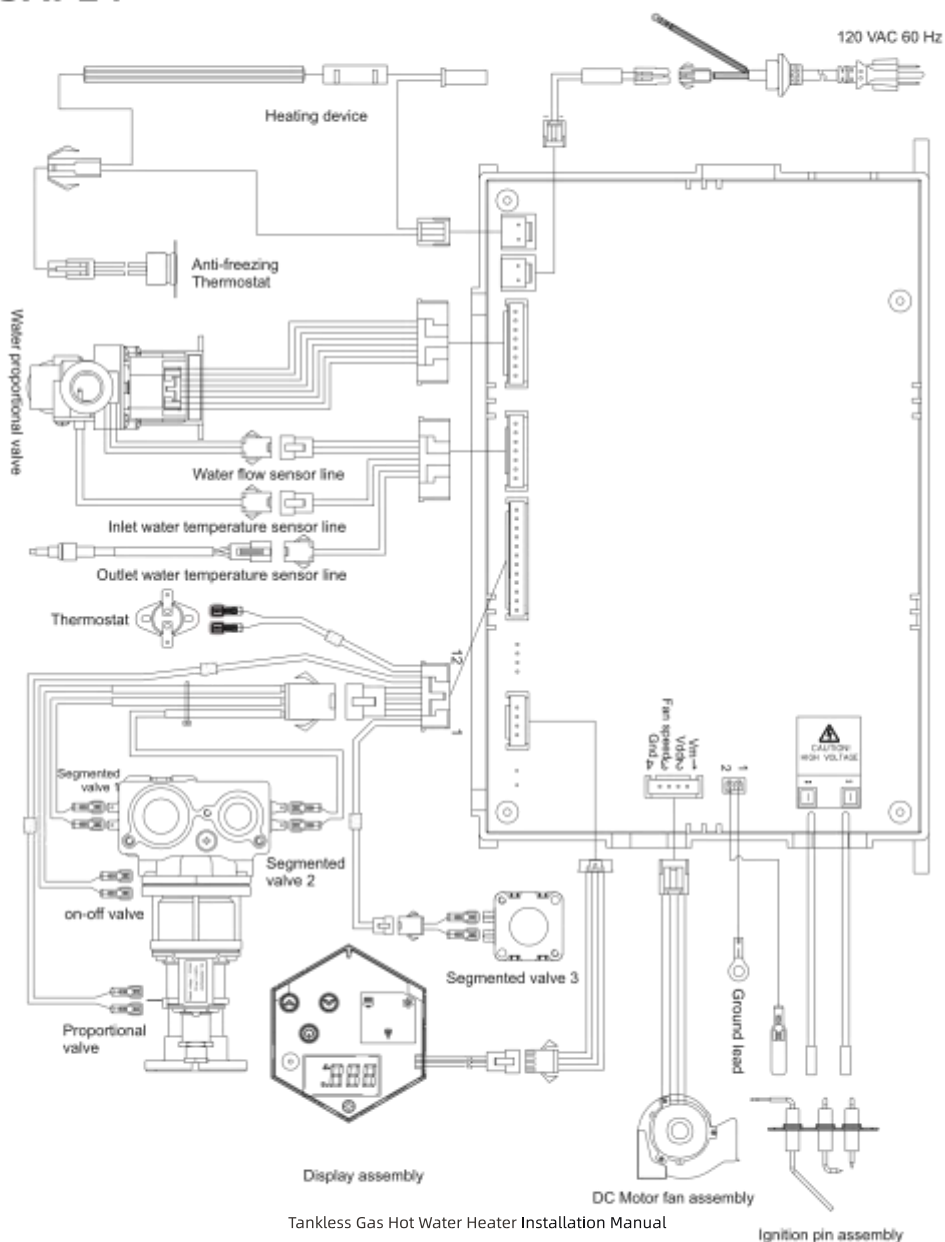

# Wiring Diagram

## SAP24



# Packing List

Check if the following items are included in the water heater.

Gas water heater	Installation manual and owner's guide	Fittings bag
 QTY1	 QTY1	 QTY1
Warranty	Service Card	Perforated Paper
 QTY1	 QTY1	 QTY1



# Eztankless



**Tel: 765-885-5125 | E-mail: [support@eztankless.com](mailto:support@eztankless.com)**

1.05.06.4026