

POWERSMART[®]

INSTRUCTION MANUAL

4400W Open Frame Inverter Generator

Model # PS5040

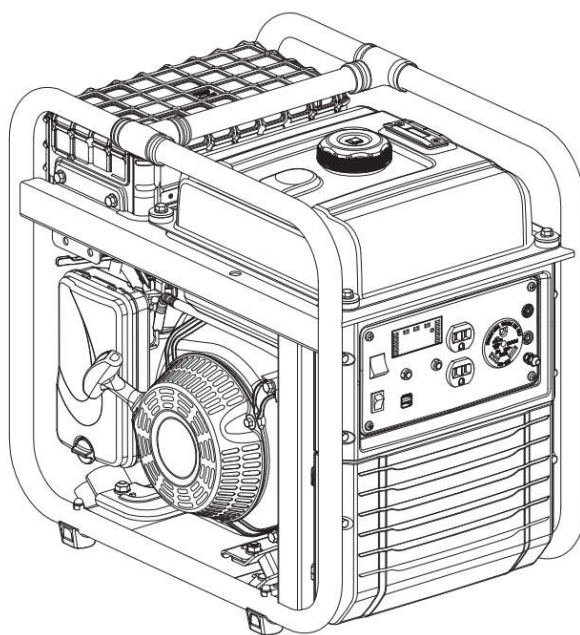

Have product questions or need technical support? Please feel free to contact us!

Website: www.Amerisuninc.com
www.powersmartusa.com

Toll free: 1-800-791-9458 M-F 9-5 EST

Email: support@amerisuninc.com

CONTENTS

Technical data.....	3
Introduction.....	4
Safety information.....	4
General safety rules	5
Important safety instructions.....	6
Symbols.....	7
Knowing your generator.....	8
Generator preparation.....	10
Starting the generator.....	13
Using the generator.....	15
Stopping the generator.....	17
Maintenance.....	17
Storage & transport procedures.....	20
Troubleshooting.....	21
Wiring diagram.....	22
Exploded view & parts list.....	23
Warranty statement.....	28

TECHNICAL DATA

4400W Open Frame Inverter Generator	Model # PS5040
Engine type:	4 stroke, OHV, single cylinder with forced air-cooling system
Spark plug gap:	0.6-0.8 mm (0.024-0.031 in.)
Displacement:	224 cc
Fuel tank capacity:	2.54 gallons
Oil capacity:	20.3 fl.oz
Rated wattage:	3500W
Starting wattage:	4400W
Rated voltage:	120V
Rated current:	29.2A
Frequency:	60Hz
Phase:	Single
USB output voltage:	5V
Dimensions (L x W x H):	20.9 x 13.8 x 19.3 inches
Noise rating:	68 dB at 23Feet
Weight:	72.8 lbs.

INTRODUCTION

Thank You for Purchasing a PowerSmart® Product. This manual provides information regarding the safe operation and maintenance of this product. Every effort has been made to ensure the accuracy of the information in this manual. PowerSmart® reserves the right to change this product and specifications at any time without prior notice.



Please keep this manual available to all users during the entire life of the generator.

This manual contains special messages to bring attention to potential safety concerns, generator damage as well as helpful operating and servicing information. Please read all the information carefully to avoid injury and machine damage.

QUESTIONS? PROBLEMS?

Please contact our Customer Service Dept. with any questions and/or comments, either by Email: support@amerisuninc.com, or Toll Free at (800)791-9458. We are available Mon-Fri 9am-5pm EST to help solve any issues that you might encounter.

NOTICE REGARDING EMISSIONS

Engines that are certified to comply with U.S. EPA emission regulations for SORE (Small Off Road Equipment), are certified to operate on regular unleaded gasoline, and may include the following emission control systems: (EM) Engine Modifications and (TWC) Three-Way Catalyst (if so equipped).

SAFETY INFORMATION

Before operating this generator, read and observe all warnings, cautions, and instructions on the generator and in this Owner's Manual.

NOTE: The following safety information is not meant to cover all possible conditions and situations that may occur. Read the entire Owner's Manual for safety and operating instructions. Failure to follow instructions and safety information could result in serious injury or death.

This safety alert symbol is used to identify safety information about hazards that can result in personal injury.



A signal word (DANGER, WARNING, or CAUTION) is used with the alert symbol to indicate the likelihood and the potential severity of injury. In addition, a hazard symbol may be used to represent the type of hazard.

DANGER Indicates a hazard, which, if not avoided, will result in death or serious injury.

WARNING Indicates a hazard, which, if not avoided, could result in death or serious injury.

CAUTION Indicates a hazard, which, if not avoided, might result in minor or moderate injury.

CAUTION when used without the alert symbol, indicates a situation that could result in damage to the engine or generator.

GENERAL SAFETY RULES

For any questions regarding the hazard and safety notices listed in this manual or on the product, please call (800) 791-9458 Mon-Fri 9-5 EST before using the generator. Please read and understand the instructions in this manual before starting the engine or attempting to operate this unit.

DANGER: CARBON MONOXIDE

Using a generator indoors **CAN KILL YOU IN MINUTES**. Generator exhaust contains carbon monoxide (CO). This is a poison gas you cannot see or smell. If you can smell the generator exhaust, you are breathing CO. But even if you cannot smell the exhaust, you could be breathing CO.

NEVER use a generator inside homes, garages, crawlspaces, or other partly enclosed areas. Deadly levels of carbon monoxide can build up in these areas. Using a fan or opening windows and doors does **NOT** supply enough fresh air. **ONLY** use a generator outside and far away from windows, doors, and vents. These openings can pull in generator exhaust.

Even if you use a generator correctly, CO may leak into the home. **ALWAYS** use a battery-powered or battery-backup CO alarm in the home. If you start to feel sick, dizzy, or weak after the generator has been running, move to fresh air **RIGHT AWAY**. See a doctor. You may have carbon monoxide poisoning.



WARNING: The exhaust from this product contains chemicals known to the State of California to cause cancer, birth defects, or other reproductive harm.



WARNING: This generator may emit highly flammable and explosive gasoline vapors, which can cause severe burns or even death if ignited. A nearby open flame can lead to explosion even if it isn't directly in contact with gasoline.

- Do not operate near open flame.
- Do not smoke near generator.
- Always operate on a firm, level surface.
- Always turn generator off before refueling. Allow generator to cool for at least 2 minutes before removing fuel cap. Loosen cap slowly to relieve pressure in tank.
- Do not overfill fuel tank. Gasoline may expand during operation. Do not fill to the top of the tank. Allow for expansion.
- Always check for spilled fuel before operating.
- Empty fuel tank before storing or transporting the generator.



WARNING: This generator produces powerful voltage, which can result in electrocution.

ALWAYS ground the generator before using it (see the “Ground the Generator” portion of the “GENERATOR PREPARATION” section).

Generator should only be plugged into electrical devices, either directly or with an extension cord.

NEVER connect to a building electrical system without a qualified electrician. Such connections must comply with local electrical laws and codes. Failure to comply can create a back-feed, which may result in serious injury or death to utility workers.

- Use a ground fault circuit interrupter (GFCI) in highly conductive areas such as metal decking or steel work. GFCIs are available in-line with some extension cords.
- Do not use in rainy conditions.
- Do not touch bare wires or receptacles (outlets).
- Do not allow children or non-qualified persons to operate.



WARNING: This generator produces heat when running. Temperatures near exhaust can exceed 150°F (65°C).

Do not touch hot surfaces. Pay attention to warning labels on the generator identifying hot parts of the machine.

Allow generator to cool down after use before touching engine or areas of the generator that become hot during use.

CAUTION: Misuse of this generator can damage it or shorten its life.

Only use generator for its intended purposes.

Operate only on dry, level surfaces.

Allow generator to run for several minutes before connecting electrical devices.

Shut off and disconnect any malfunctioning devices from generator.

Do not exceed the wattage capacity of the generator by plugging in more electrical devices than the unit can handle.

Do not turn on electrical devices until after they are connected to the generator.

Turn off all connected electrical devices before stopping the generator.

Turn the engine switch to “OFF” position when the engine is not running.

IMPORTANT SAFETY INSTRUCTIONS

SAVE THESE INSTRUCTIONS – This manual contains important instructions for the PowerSmart® 4400W generator that should be followed during installation and maintenance of the generator.

Generators vibrate in normal use. During and after the use of the generator, inspect both the generator as well as extension and power supply cords for damage resulting from vibration. Have damaged items repaired or replaced as necessary. Do not use plugs or cords that show signs of damage such as broken or cracked insulation.











For power outages, permanently installed stationary generators are better suited for providing backup power to the home. Even a properly connected portable generator can become overloaded. This may result in overheating or stressing of the components, possibly leading to a generator failure.



WARNING: If this generator is used as a supply for a building’s wiring system, the generator must be installed by a qualified electrician and connected to a transfer switch as a separately derived system in accordance with the National Electrical Code, NFPA 70. The generator shall be connected to a transfer switch that switches all conductors excluding the equipment grounding conductor. The frame of the generator shall be connected to an approved grounding electrode.

SYMBOLS

Some of the following symbols may be used on this product. Please study them and learn their meaning. Proper interpretation of these symbols will allow you to operate the product better and safer.

SYMBOL	NAME	DESIGNATION/EXPLANATION
V	Volts	Voltage
A	Amperes	Current
Hz	Hertz	Frequency (cycles per second)
W	Watts	Power
MIN	Minutes	Time
	Safety Alert	Precautions that involve your safety.
	Read the user's manual	To reduce the risk of injury, user must read and understand user's manual before using this product.
	Carbon monoxide hazard	Never operate the generator in an enclosed area. Engine exhaust contains carbon monoxide. Only operate the generator outside and away from windows, doors and vents.
	Ground	Consult with local electrician to determine grounding requirements before operation.
	Clearance	Keep all objects at least 5 feet (1.5m) from generator. Heat from the muffler and exhaust gas can ignite combustible objects.
	Electric shock alert	Beware of electric shock hazard.
	Fire/Explosion	Fuel and its vapors are extremely flammable and explosive. Fire or explosion can cause severe burns or death. Keep generator at least 5 feet (1.5m) from all objects to prevent combustion.
	Wet conditions alert	Do not expose to rain or use in damp locations.
	Hot Surface	To reduce the risk of injury or damage, avoid contact with any hot surface.
	Open Flame Alert	Fuel and its vapors are extremely flammable and explosive. Keep fuel away from smoking, open flames, sparks, pilot lights, heat, and other ignition sources.

KNOWING YOUR GENERATOR

Use the illustrations below to become familiar with the locations and functions of the various components and controls of this generator.

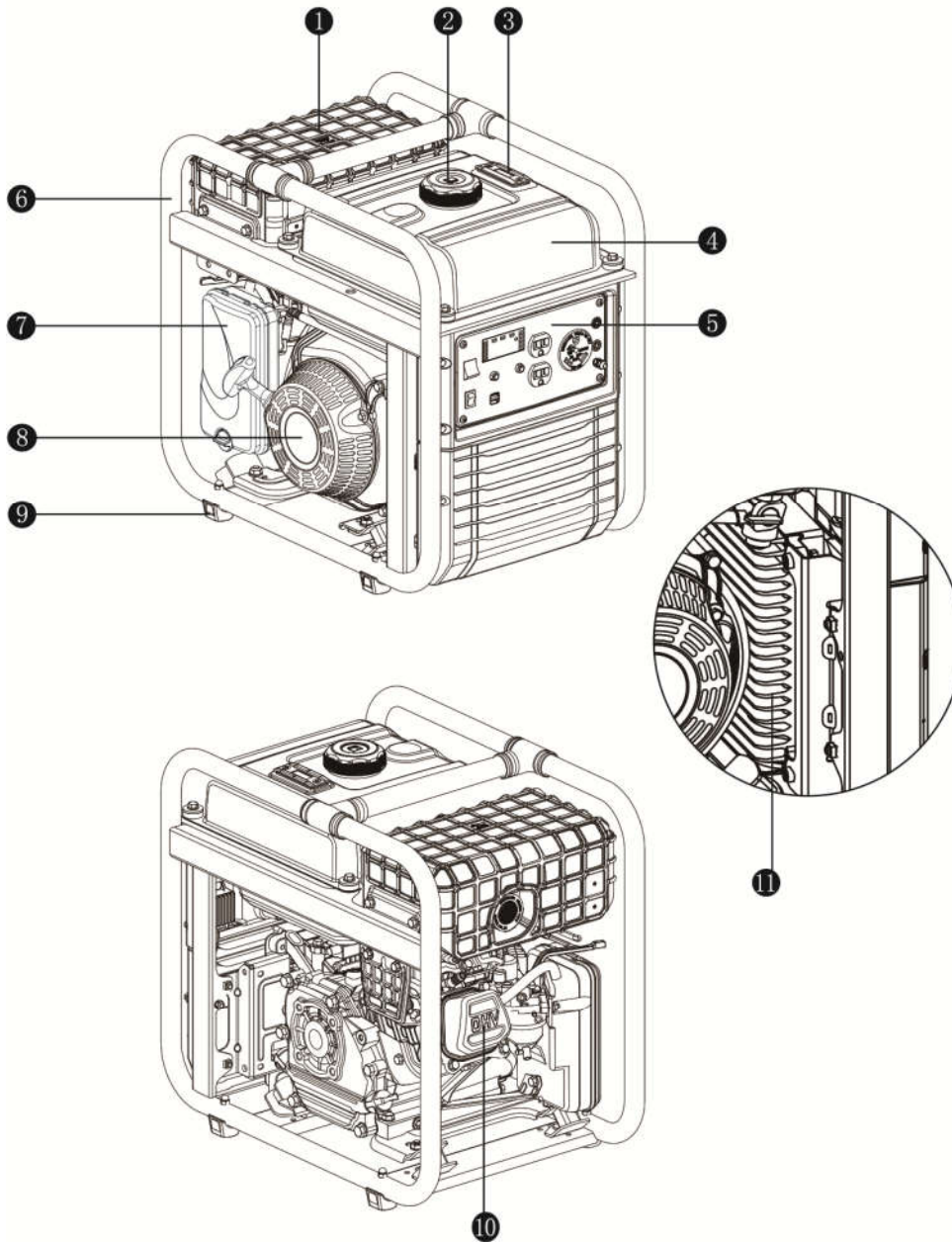

- | | | |
|------------------------|------------------|------------|
| ① Muffler | ⑥ Rack | ⑪ Inverter |
| ② Fuel cap | ⑦ Air filter | |
| ③ Fuel level indicator | ⑧ Starter | |
| ④ Fuel tank | ⑨ Supporting leg | |
| ⑤ Control panel | ⑩ Valve cover | |

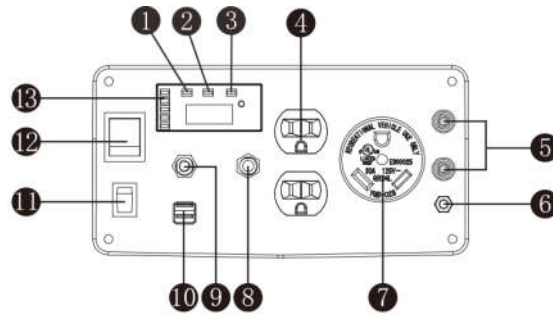

- | | | |
|--|-------------------------|---------------------|
| ① Oil alarm lamp | ② Overload indicator | ③ Running indicator |
| ④ AC output receptacle | ⑤ Parallel kit terminal | ⑥ Ground terminal |
| ⑦ AC American-type three-hole receptacle | ⑧ AC breaker | ⑨ DC breaker |
| ⑩ USB | ⑪ Energy-saving switch | ⑫ Engine Switch |
| ⑬ Load indicator | | |

Parallel kit terminal

It used for parallel operation with another inverter (parallel kit sold separately)

Running indicator (green)

The running indicator lights up when generating set starts and has normal output.

Overload indicator (red)

When the overload indicator is on, it indicates that the generating set is overload and it may cause overheat of frequency converter, or increase of AC voltage. And then the AC protector works. It will stop the output of generating set to protect the electric equipment and the generating set itself. At this time, the running indicator (green) is off and the overload indicator (red) is on, but the engine is still in running state.

When the generating set has no output and the overload indicator is on, please take the following steps:

1. Lower the total power of the connected electric devices to the rated output range of generating set.
2. Check the air intake for impurities and check the control parts for abnormal situation. Handle immediately if necessary.
3. Press the reset button.

Oil alarm lamp (yellow)

When the oil level drops below the lower limit, the oil protection system will stop the engine automatically and oil alarming lamp will blink by pulling the recoil starter. The engine will not run until the oil has been filled to the proper level.

Note: If engine flames out or fails to start, please adjust Engine switch to “ON” position and then pull the recoil starter. If the oil alarming lamp lights up, it shows lack of oil. Please add appropriate oil and restart the engine.

Energy-saving switch

When the energy-saving switch is in “ON” position, the energy saving equipment controls the engine rotate speed according to the connected loads. There will be good fuel consumption and low noise.

When the energy-saving switch is in “OFF” position, the engine will always run in rated rotate speed no matter it is connected to the loads or not (See the parameter table for details).

Note: Please set the energy-saving switch to “OFF” position when connect to air compressor, sinking pump etc. because these equipments need large starting current.

GENERATOR PREPARATION

The following section describes steps necessary to prepare the generator for use. If after reading this section, you are unsure about how to perform any of the steps please call (800) 791-9458 Mon-Fri 9-5 EST for customer service. Failure to perform these steps properly can damage the generator or shorten its lifespan.

Unpacking

Unpack the generator and all its parts. Do not discard the carton or any packaging until the generator is completely assembled.

Step 1 - ADD OIL



WARNING: This engine is not filled with oil before send out to the factory. User must add the proper amount of oil before operating the generator for the first time. Any attempt to crank or start the engine before it has been properly filled with the recommended type and amount of oil may result in engine damage and void your warranty.

The oil capacity of the engine crankcase is 20.3 fl. oz. For general use (above 40° F), we recommend 10W-30, 4-stroke engine oil.

ENGINE OIL RECOMMENDATIONS

Select good quality detergent oil bearing the American Petroleum Institute (API) service classifications SJ, SL, or SM (synthetic oils may be used). Use the ASE viscosity grade of oil from the following chart that matches the starting temperature anticipated before the next oil changes.

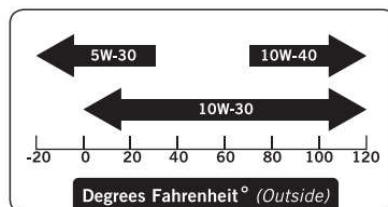

Engine Oil Temperature Recommendations

To add oil, follow these steps:

1. Place the engine on a level surface with engine stopped.
2. Remove the dipstick (See fig.1) and wipe it clean.
3. Reinstall dipstick into tube, rest on oil fill neck, DO NOT thread cap into tube.
Remove the dipstick again and check oil level. Level should be at top of indicator on dipstick.
4. Fill to the upper limit (marked with "H") of the dipstick with the recommended oil if the oil level is low (See fig.2).
5. Reinstall and fully tighten the dipstick.

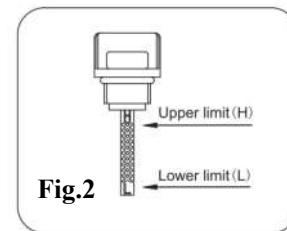
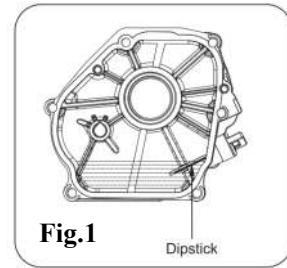

CAUTION: Operate generator only on a level surfaces. The engine is equipped with a low oil sensor (applicable types) that will automatic stop the engine when the oil level falls below the safe limit. To avoid the inconvenient of an unexpected shutdown, fill to the upper limit and check the oil level regularly.

Step 2 - ADD GASOLINE



WARNING: This generator may emit highly flammable and explosive gasoline vapors, which can cause severe burns or even death if ignited. A nearby open flame can lead to explosion even if not directly in contact with gasoline.

Use clean, fresh, regular unleaded gasoline with a minimum octane rating of 87. Do not mix oil with gasoline. Always wipe up any spilled fuel.

To add gasoline, follow these steps:

1. Make sure the generator stopped and it is on a level surface.
2. Unscrew fuel cap and set aside.
NOTE: The fuel cap may be tight and hard to unscrew.
3. Slowly add unleaded gasoline to the fuel tank. Be careful not to overfill.
The capacity of the fuel tank is 2.54 gallons (See fig.3).
NOTE: Do not fill the fuel tank to the very top. Gasoline will expand and spill over during use even with the fuel cap in place.
4. Reinstall fuel cap and wipe clean any spilled gasoline with a dry cloth.

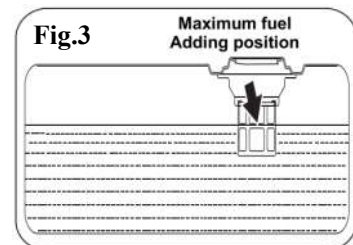

IMPORTANT:

- Do not fill tank indoors.
- Do not fill tank when the engine is running or hot.
- Never use an oil/gasoline mixture.
- Never use old gasoline.
- Avoid getting dirt or water into the fuel tank.
- Gasoline can age in the tank and make starting difficult. Never store generator for extended periods of time with fuel in the tank or the carburetor.
- Turn the fuel cock off and drain the fuel from the carburetor.

NOTICE:

- Never use engine or carburetor cleaner products in the fuel tank or permanent damage may occur.
- It is important to prevent gum deposits from forming in essential fuel system parts, such as the carburetor, fuel filter, fuel hose or tank during storage. Also, experience indicates that alcohol-blended fuels (called gasohol, ethanol or methanol) can attract moisture, which leads to separation and formation of acids during storage.
Acidic fuel can damage the fuel system of the generating set while in storage. Be sure to review the instruction given in “Storage” section.
- Gasoline/ Alcohol Blends: up to 10% alcohol, 90% unleaded gasoline by volume is approved as a fuel. Other gasoline/alcohol blends are not approved.
- Effects of old, stale or contaminated fuel are not warrantable.

Step 3 - GROUND THE GENERATOR

WARNING: Failure to properly ground the generator can result in electrocution.

The generator must be properly connected to an appropriate ground. It helps prevent electrical shock if ground fault condition exists in the generator or in connected electrical devices, especially when the unit is equipped with a wheel kit. Proper grounding also helps dissipate static electricity, which often builds up in ungrounded devices.

A ground terminal on the frame of the generator has been provided on the generator end. For remote grounding, connect a length of heavy gauge(4mm²) copper wire between the generator ground terminal and a copper rod driven into the ground.

The National Electrical Code requires that the frame and external electrically conductive parts of this generator be properly connected to an approved earth ground.

Local electrical codes may also require proper grounding of the unit. We strongly recommend that you consult with a qualified electrician for grounding requirements in your area.

ELECTRICAL DEVICES

Disconnect all electrical devices from the generator and switch off the AC circuit breaker before start the engine.

The generator may be hard to start with electrical devices.

The connected electrical equipment must not exceed the maximum limit of the generator. Please refer to the specification table for details.

NOTE: After completing the above preparation, the generator is ready to be started.

STARTING THE GENERATOR

Before starting the generator, make sure you have read and performed the steps in the “Generator Preparation” section of this manual. If you are unsure about how to perform any of the steps in this manual, please call (800) 791-9458 Mon-Fri 9-5 EST or email: support@amerisuninc.com for customer service.



DANGER: CARBON MONOXIDE.

Using a generator indoors CAN KILL YOU IN MINUTES.

Generator exhaust contains carbon monoxide (CO). This is a poison gas you cannot see or smell. If you can smell the generator exhaust, you are breathing CO. Even if you cannot smell the exhaust, you may be breathing CO.

NEVER use a generator inside homes, garages, crawlspaces, or other partly enclosed areas. Deadly levels of carbon monoxide can build up in these areas. Using a fan or opening windows and doors does NOT supply enough fresh air.

ONLY use a generator outside and far away from windows, doors, and vents. These openings can pull in generator exhaust. Even if you use a generator correctly, CO may leak into the home. **ALWAYS** use a battery-powered or battery-backup CO alarm in the home.

If you start to feel sick, dizzy, or weak after the generator has been running, move to fresh air **RIGHT AWAY**. See a doctor. You may have carbon monoxide poisoning.



WARNING: This generator produces powerful voltage, which can result in electrocution.

ALWAYS ground the generator before using it (see the “Ground the Generator” portion of the “Generator Preparation” section).

- Generator should only be plugged into electrical devices, either directly or with an extension cord. **NEVER** connect to a building electrical system without a qualified electrician. Such connections must comply with local electrical laws and codes. Failure to comply can create a back-feed, which may result in serious injury or death to utility workers.
- Use a ground fault circuit interrupter (GFCI) in highly conductive areas such as metal decking or steel work. GFCIs are available in-line with some extension cords.
- Do not use in rainy or wet conditions.
- Do not touch bare wires or receptacles (outlets).
- Do not allow children or non-qualified persons to operate.

CAUTION: Disconnect all electrical loads from the generator before attempting to start.

STARTING THE ENGINE

To start the generator, perform the following steps:

1. Turn the fuel valve to the “ON” position (See fig.4).

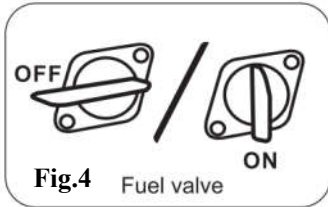

2. Pull the choke valve switch to “OFF” position (See fig.5).

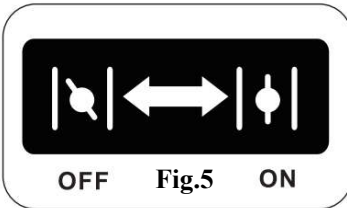

When in cold engine status, turn the choke valve to “ON” position, or turn it to “half -open” position. When in hot engine status. When fail to start the engine for twice, fully open the choke then operate switch or recoil.

CAUTION: Choke plate should be setting in different width due to temperature and other factors.

3. Turn the switch to “ON” position. The switch button according to the open position, and then seize the starter handle and slow pulling until there is a sense of resistance so far, and quickly pull to start (See fig.6).

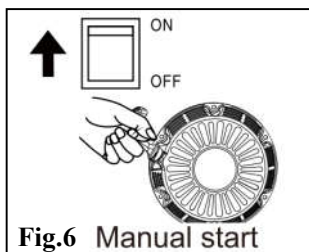

WARNING: Rapid retraction of the starter cord will pull hand and arm towards the engine faster than you can let go.

Unintentional startup can result in entanglement, traumatic amputation or laceration. Broken bones, fractures, bruises or sprains.

4. When starting, slowly turn choke lever to “ON” position as temperature rises. If engine runs unstable (with shake), shift the lever to “half-open” position until the engine runs stable before rest the lever to “ON” position (See fig.7).

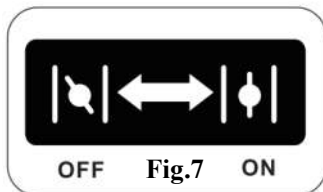



WARNING: During the engine warm up, partly open for the choke is necessary until the temperature to a certain level.

5. The generator may be normally loaded.



WARNING: Connect the output terminal of the generator with the electric equipment. Do not start or stop the engine when the electric equipment is in “ON” status.

USING THE GENERATOR

CONNECT TO ELECTRICAL DEVICES

1. Inspect power cord for damage before using. There is a hazard of electrical shock from crushing, cutting or heat damage.
2. Allow the engine to stabilize and warm up for a few minutes after starting.
3. Make sure that the generating set has been properly grounded. If the electric devices require grounding, the generating set must ground.
4. Make sure that the electric devices are in “OFF” position. And the load current is not higher than the maximum withstanding current of single socket.
5. Connect and start the electric devices.
6. Turn off all electric devices and disconnect them from the generating set.
7. If the generating set supplies for several loads or electric devices, start the smallest one first and the largest one last.



DANGER: To reduce the risk of electrical shock, DO NOT use electrical cords that are worn, frayed, bare or otherwise damaged. DO NOT touch bare wires or receptacles. DO NOT handle generating set or electrical cords while standing in water, while barefoot, or while hands or feet are wet.

LOADING CAPACITY



WARNING: Do not overload the generating set. Exceeding the generating set’s capacity can damage the generating set and/or electric devices

connected to it.

You must make sure your generating set can supply enough rated (running) and (starting) watts for the electrical devices at the same time. Follow these simple steps to calculate the running and starting watts necessary for your purposes.

1. Count the electrical devices you will power at the same time.
2. The amount of power you need to run all the devices is the total rated (running) watts of these items.
3. Identify how many surge (starting) watts you will need. Surge wattage is the short burst of power needed to start electric motor-driven tools or appliances such as a circular saw or refrigerator.

Because not all motors start at the same time, total surge Watts can be estimated by adding only the electrical

Electric equipment		Rate power(W)	Starting power(W)
Appliances	Tablet computer27"	80	100
	Energy saving lamb	5-50	5-50
	Electric cooker	1000	1000
	Computer	250	250
	Electric fan	50	100
	Washing machine	250	500
	Refrigerator	50	300
	Air-conditioner	1600	3200
Electric tooling	Electric hammer	1000	1500
	Impact Hammer	3000	6000
	Water pump	2200	5000
	Electric welding machine	5000	7500
	Air compressor	5000	10000

Wattage Reference Chart

device(s) with the highest additional surge watts to the total rated watts from step 2.



WARNING: You must isolate the generator from electric utility by opening the electrical system's main circuit breaker or main switch if the generator is used for backup power. Failure to isolate the generator from the power utility may result in injury or death to electric utility workers and damage to the generator due to backfeed of electrical energy.



CAUTION: When the overload indicator is on (See fig.8), it indicates that the generating set is overload and it may cause overheat of frequency converter, or increase of AC voltage. And then the AC protector works. It will stop the output of generating set to protect the electric equipment and the generating set itself. At this time, the running indicator(green) is off and the overload indicator(red) is on, but the engine is still in running set.

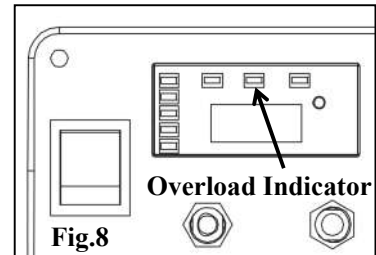

When the generating set has no output and the overload indicator is on, please take the following steps:

1. Lower the total power of connected electric devices to the rated output range of generating set.
2. Check the air intake for impurities and check the control parts for abnormal situation. Handle immediately if necessary.
3. Press the reset button (See fig.9).

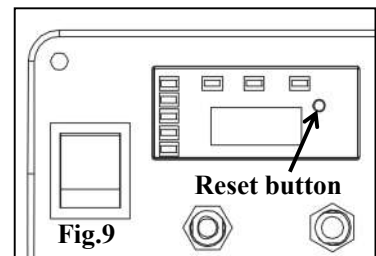

PARALLEL OPERATION

Make sure that the generating set is in a good running state before connecting it to other generating sets. The total power of electric devices should not exceed rated power of generating set.

When electric motor starts, the overload indicator (red) will light up and normally it will stop within 4 seconds. If it cannot stop, please call (800) 791-9458 Mon-Fri 9-5 EST or email: support@amerisuninc.com for customer service.

During parallel operation, energy-saving switches of generating sets should be in the same position. To parallel operation, perform the following steps:

1. Connect one generating set to other generating set(s) in parallel. Use the parallel kit to make the parallel connection (the parallel kit needs to be purchased separately).
2. Start the engine in proper order and make sure that the running indicator (green) is normal.
3. Connect the plug of electric devices to the AC receptacle of parallel kit.
4. Run the electric devices.



CAUTION: When overload too much, overload indicator (red) blinks continuously, and the generating set may be damaged. When overload a little, overload indicator (red) lights up continuously, it may shorten the service life of generating set. When continuously operating the generating set, power cannot exceed the rated power of generating set.

The total power of electric devices cannot exceed the rated power of generating set. The manufacturers of electric devices or tools always list the rated power of similar models or serial number.

STOPPING THE GENERATOR



WARNING: Never stop the engine with electrical devices connected and with the connected devices turn “ON”.

1. Remove all the load on generator.
2. Allow the generator run at no load for a few minutes to stabilize internal temperatures of the engine and generator.
3. Turn the engine switch to “OFF” position.(See fig.10)

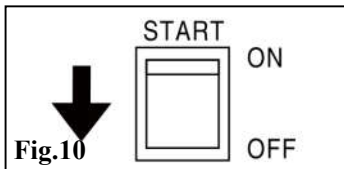

4. Turn the fuel valve to “OFF” position (See fig.11).

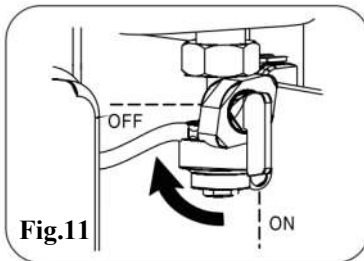

5. Remove the plug of all electric equipment from the generator panel (See fig.12).

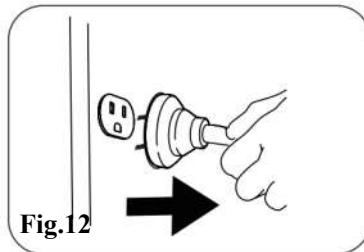

MAINTENANCE



WARNING: Accidental starts can cause severe injury or death. Remove and ground spark plug wire before performing any service.



WARNING: The filter element may contains PAHs, PAHs are harmful for your health. Please wear gloves for protection during air filter maintenance.

Proper routine maintenance of the generator will help prolong the life of the machine. Please perform maintenance checks and operations according to the schedule in below chart.

		Each time before use	10 hours or the first month ^{Note2}	50 hours or every three months ^{Note2}	100 hours or every six months ^{Note2}	300 hours or every year ^{Note2}
Engine oil	Inspection	√				
	Replacement		√		√	
Air filter	Inspection	√				
	Cleaning			√ ^{Note3}		
Spark plug	Inspection and adjustment				√	
	Replacement					√
Spark Arrester ^{Note1}	Cleaning				√	
Idle speed	Inspection and adjustment					√ ^{Note4}
Valve clearance	Inspection and adjustment					√ ^{Note4}
Low permeability oil tube ^{Note1}	Inspection	Every two years ^{Note4}				
Oil tube	Inspection	Every two years ^{Note4}				

NOTE:

Note1: Applicable types (if available).

Note2: Before each season and after then (whichever comes first).

Note3: Service more frequently under severe , dusty, dirty conditions.

Note4: To be performed by knowledgeable, experienced owners or the authorized dealer.

GENERATOR MAINTENANCE



WARNING: Never clean the generator when it is running! Never use water to clean the generating set. Water can enter the generating set through the cooling slots and damage the generating set windings.



WARNING: Do not modify the generator in any way. Do not tamper with governed speed. Generator supplies correct rated frequency and voltage when running at factory set. Tampering with the factory set governor will void your warranty.

- Make certain that the generator is kept clean and stored properly.
- Use a damp cloth to clean exterior surfaces of the generating set. Use a soft brush to clean the dirt and oil.
- Use an air compressor (25 PSI) to clear dirt and debris from the generating set.
- Inspect all air vents and cooling slots to ensure that they are clean and unobstructed.

ENGINE MAINTENANCE

Checking the oil

The oil capacity of the engine crankcase is 20.3 fl. oz.

1. Place the engine on a level surface with engine stopped. Check the engine oil level. Remove the oil maintenance cover. Remove the dipstick and wipe it clean.
2. Reinstall dipstick into hole, rest on oil fill neck, DO NOT thread cap into hole.
3. Remove the dipstick again and check oil level. Level should be between the upper and lower limit. Fill to the upper limit of the dipstick with the recommended oil if the oil level is too low.
4. Reinstall and fully tighten the dipstick.

Changing the oil



WARNING: Change the oil when in hot engine state. The oil can reach up to 140°C under that condition. Careful operation should be taken to prevent burns.

1. Place the engine on a level surface.
2. Clean area around dipstick and drain plug.
3. Remove the oil dipstick (See fig.13).
4. Remove the oil drain plug and allow the oil to drain completely.
5. Unscrew the oil gauge after tightening the drain bolts.
6. Add recommended oil to the upper limit (see add oil instruction above).
7. Reinstall and fully tighten the dipstick.

Dispose of used oil at an approved waste management facility.

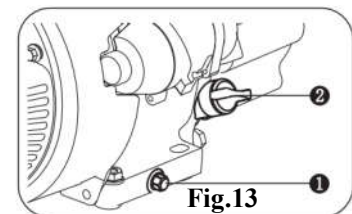

1 Oil drain plug 2 Dipstick

AIR FILTER

Routine maintenance of the air cleaner helps maintain proper airflow to the carburetor. Occasionally check that the air cleaner is free of excessive dirt.

1. Loosen the filter fix bolt and remove the cover of the air filter (See fig.14).
2. Remove the foam filter element.
3. Wash in liquid detergent and warm water.
4. Squeeze thoroughly dry in a clean cloth.
5. Saturate in clean engine oil.
6. Squeeze in a clean, absorbent cloth to remove all excess oil.
7. Place the filter in the assembly.
8. Fasten the air filter cover with the fix bolt, and the mounting it back to the air filter body.

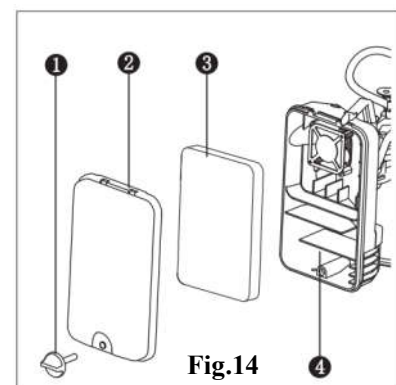

1 Filter fix bolt
2 Air filter cover
3 Foam filter element
4 Air filter body



WARNING: Do not run the engine without the air filter, or serious danger can result.

SPARK PLUG

Spark plug gap : 0.6mm-0.8mm(0.024-0.031 in).

Spark plug tighten torque: 15-20N.m

The spark plug is important for proper engine operation. A good spark plug should be intact, free of deposits, and properly gapped. Refer to Recommended Maintenance Schedule. To inspect the spark plug:

1. Clean any dirt from the spark plug cap and spark plug base.
2. Remove the spark plug cap.
3. Using socket wrench to loose and remove the spark plug.
4. Inspect the spark plug and spark plug washer, if it was broken or worn, replace with a new one. Clean the spark plug with wire brush if reuse it.
5. Check spark plug gap. Carefully bend side electrode to adjust the gap if necessary.
6. Carefully thread the plug into the engine by hand.
7. After the spark plug is seated, use spark plug wrench to tighten the plug.
8. Attach the spark cap to the plug and connect the spark plug wire to the plug.



CAUTION: Only use recommended spark plug or equivalent. Do not use spark plugs that have improper heat range.

SPARK ARRESTER

1. Allow the generating set to cool completely before servicing the spark arrester.
2. Remove the two bolt holding the cover plate which retains the end of the spark arrester to the muffler.
3. Remove the spark arrester screen.
4. Carefully remove the carbon deposits from the spark arrester screen with a wire brush (See fig.16).
5. Replace the spark arrester if it is damaged.
6. Reinstall the spark arrester in the muffler and attach with the two screws.

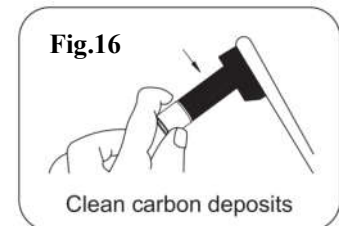

STORAGE & TRANSPORT PROCEDURES

STORAGE



WARNING: Gasoline is highly flammable and extremely explosive. Empty the fuel tank and shut off fuel valve before storing or transporting this generating set.

The generating set should be started at least once every 2 weeks and allowed to run for at least 20 minutes. Follow the instructions below for longer term storage if the generating set will be out of service for 2 months or more.

- Allow the generating set to cool completely before storage.
- Clean the generating set according to instruction in maintenance section.
- Drain all fuel completely from the fuel tank, fuel hose and carburetor to prevent gum from forming.
- Turn off the fuel supply at the fuel valve.
- Change the oil.
- Reattach the spark plug.
- Remove the spark plug and pour about 15ml of oil into the cylinder. Crank the engine slowly to distribute the oil and lubricate the cylinder.
- Store the unit in a clean, dry area out of direct sunlight.

TRANSPORT

To prevent fuel spillage when transporting or during temporary storage, the generating set should be secured upright in its normal operating position, with the engine switch OFF. The fuel valve lever should be turned OFF.

When transporting:

- Do not overfill the tank.
- Do not operate the generating set while it is on vehicle. Take the generating set off the vehicle and use it in a well-ventilated place. Avoid a place exposed to direct sunlight when putting the generating set on a vehicle. If the generating set is left in an enclosed vehicle for many hours, high temperature inside the vehicle could cause fuel to vaporize resulting in a possible explosion.
- Do not drive on a rough road for an extended period with the generating set on a rough road, drain the fuel from the generating set beforehand.

TROUBLESHOOTING

Failure	Cause	Removal method
Engine won't start.	Engine switch is "OFF".	Turn engine switch to the "ON" position.
	No Fuel.	Fill tank per instructions in this manual.
	Inadequate engine oil.	Check oil level. This engine is equipped with a low oil sensor. The engine cannot be started unless the oil level is above the prescribed lower limit.
	No ignition.	Remove the spark plug cap. Clean any dirt from around the plug base, then remove the spark plug. Install the spark plug in the plug cap. Turn the engine switch "ON". Grounding the electrode to any engine ground, pull the recoil starter to see if sparks jump across the gap. If there is no spark, replace the plug. Reinstall the plug and start engine according to instructions in this manual. Consult Customer Service if necessary.
Generator has no output.	Overload protection	Disconnect the load and push the reset button.
	Inadequate cord sets or extension cords.	Check cord sets or extension cords capabilities in section Controls; Cable Size in this manual. Consult Customer Service if necessary.

WIRING DIAGRAM

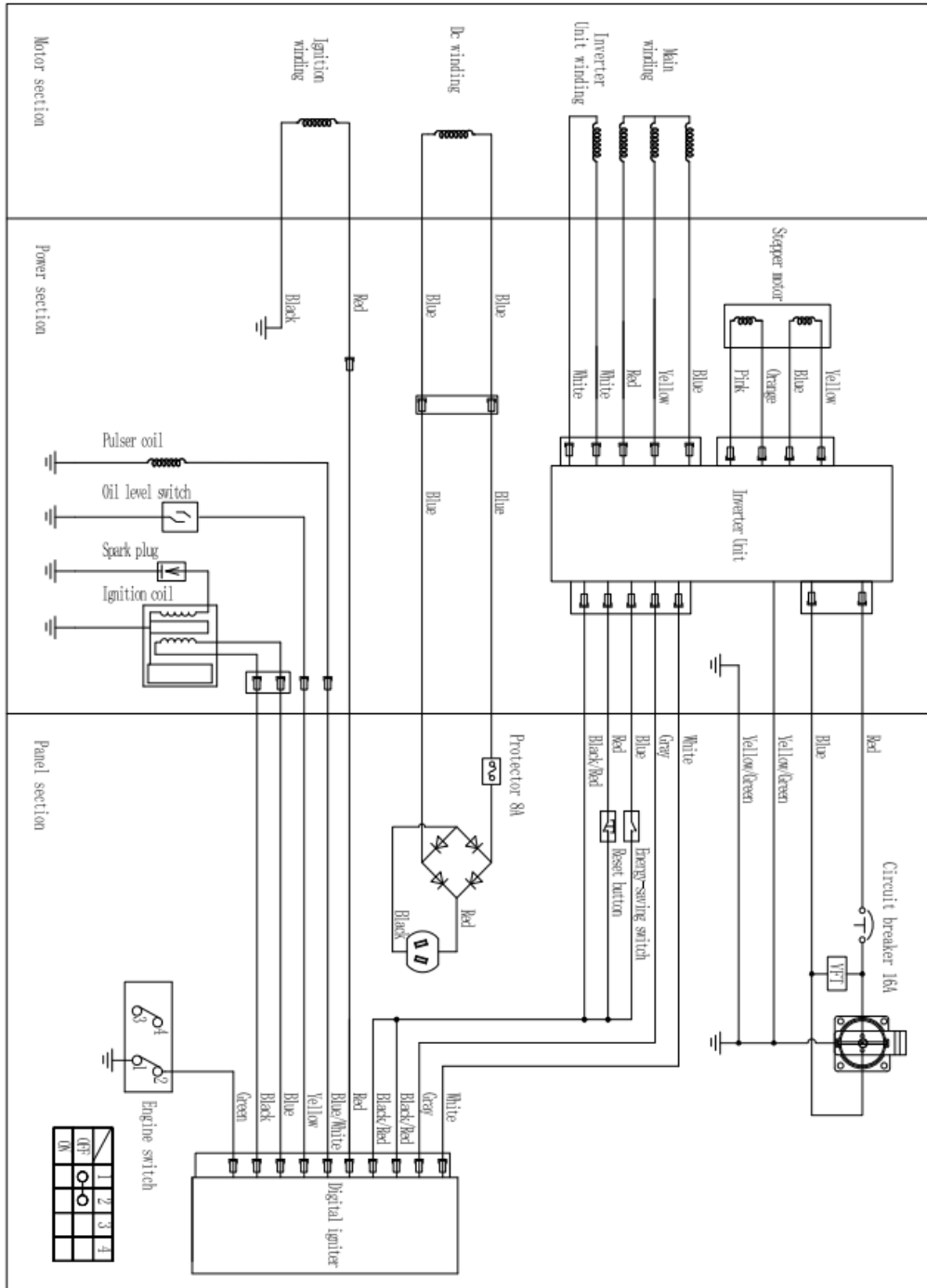

EXPLODED VIEW & PARTS LIST

Generator exploded view

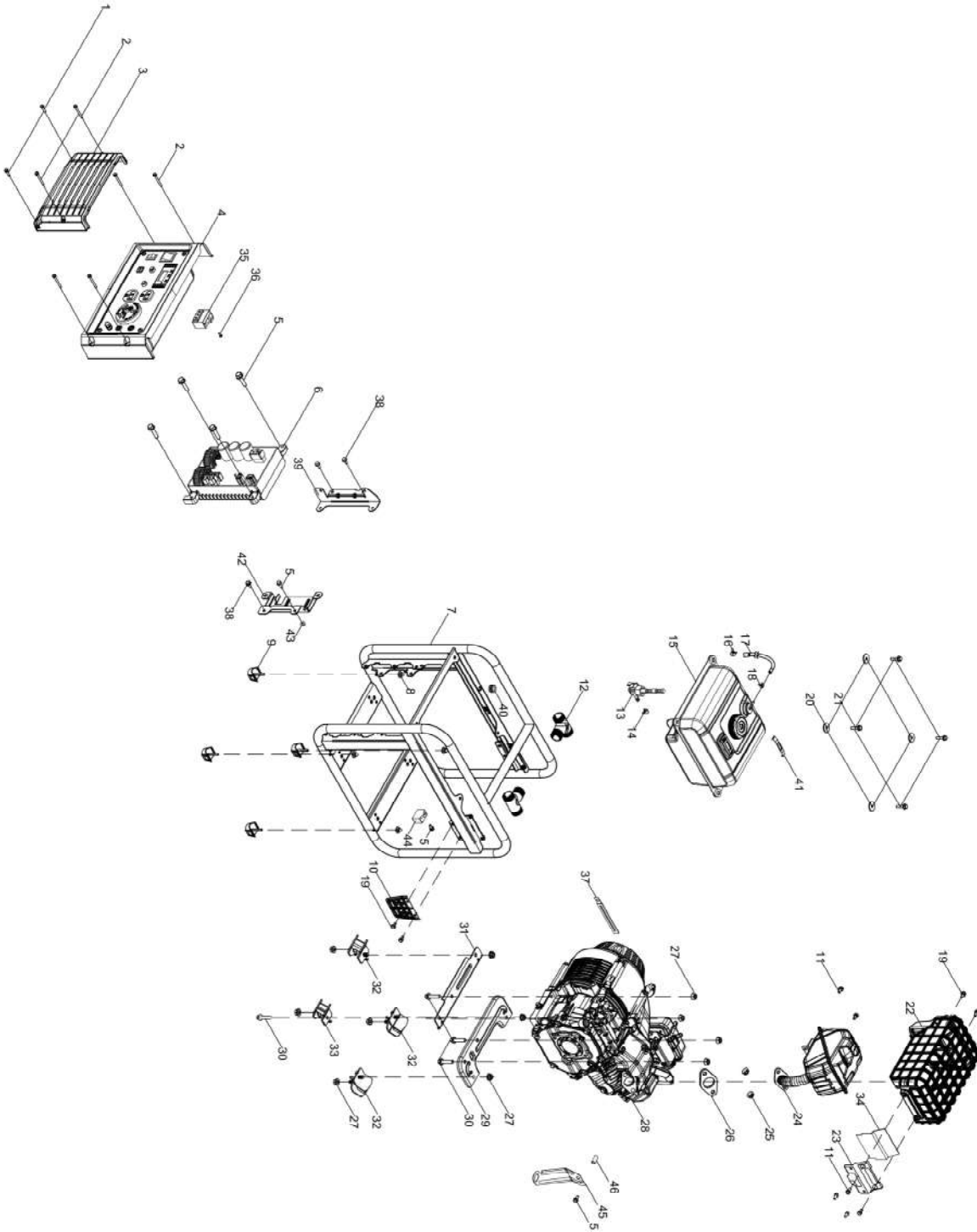

Generator parts list

Item	Stock#	Description	Qty.	Item	Stock#	Description	Qty.
1	100011533-0005	Bolt, M6×22	2	24	100122169	Muffler	1
2	100011539-0001	Bolt, M6×45	6	25	100011422-0004	Nut, M8	2
3	100087975	Inverter Protective Cover	1	26	100006526	Gasket, Muffler	1
4	100162760-0001	Control Panel	1	27	100079483-0001	Nut, M8	11
5	100011265-0003	Bolt, M6×18	7	28	1ZZDDF037	Engine	1
6	100093717	Inverter	1	29	100087976-0002	Engine Rear Board	1
7	100087978-0003	Frame Assembly	1	30	100011320-0002	Bolt, M8×35	4
8	100011135-0001	Nut, M6	4	31	100087977-0002	Engine Front Board	1
9	100093522	Damping Pad	4	32	100093524	Damping Pad	3
10	100087578	Muffler Plate	1	33	100093523	Damping Pad	1
11	100011570-0001	Bolt, M6×12	6	34	100099954	Insulation Foam	1
12	100098960	Decorating parts	2	35	100137347-0001	Ignition Module	1
13	100136320	Fuel Switch	1	36	100011250-0002	Bolt, M5×14	1
14	100005138	Clamp	1	37	100000655	Clip	1
15	100095915-0002	Fuel Tank	1	38	100011260-0005	Bolt, M6×10	3
16	100005159	Clamp	1	39	100121844-0001	Electric Starter Base	1
17	100098961	Fuel Hose	1	40	100009075	Damping Pad	1
18	100005148	Clamp	1	41	100059920-0001	Oily Sense Clip	1
19	100011261-0004	Bolt, M6×12	4	42	100127970-0001	Lithium Battery Support Board	1
20	100010439-0002	Washer, φ6.5×2×φ25	4	43	100011452-0003	Nut, M6	1
21	100011268-0003	Bolt, M6×25	4	44	100156648	Rectifier	1
22	100099957	Muffler Guard	1	45	100021030	Air Filter Bracket	1
23	100098959	Heat Insulation Board	1	46	100004232	Bush, φ12×φ6×8	1

Engine exploded view

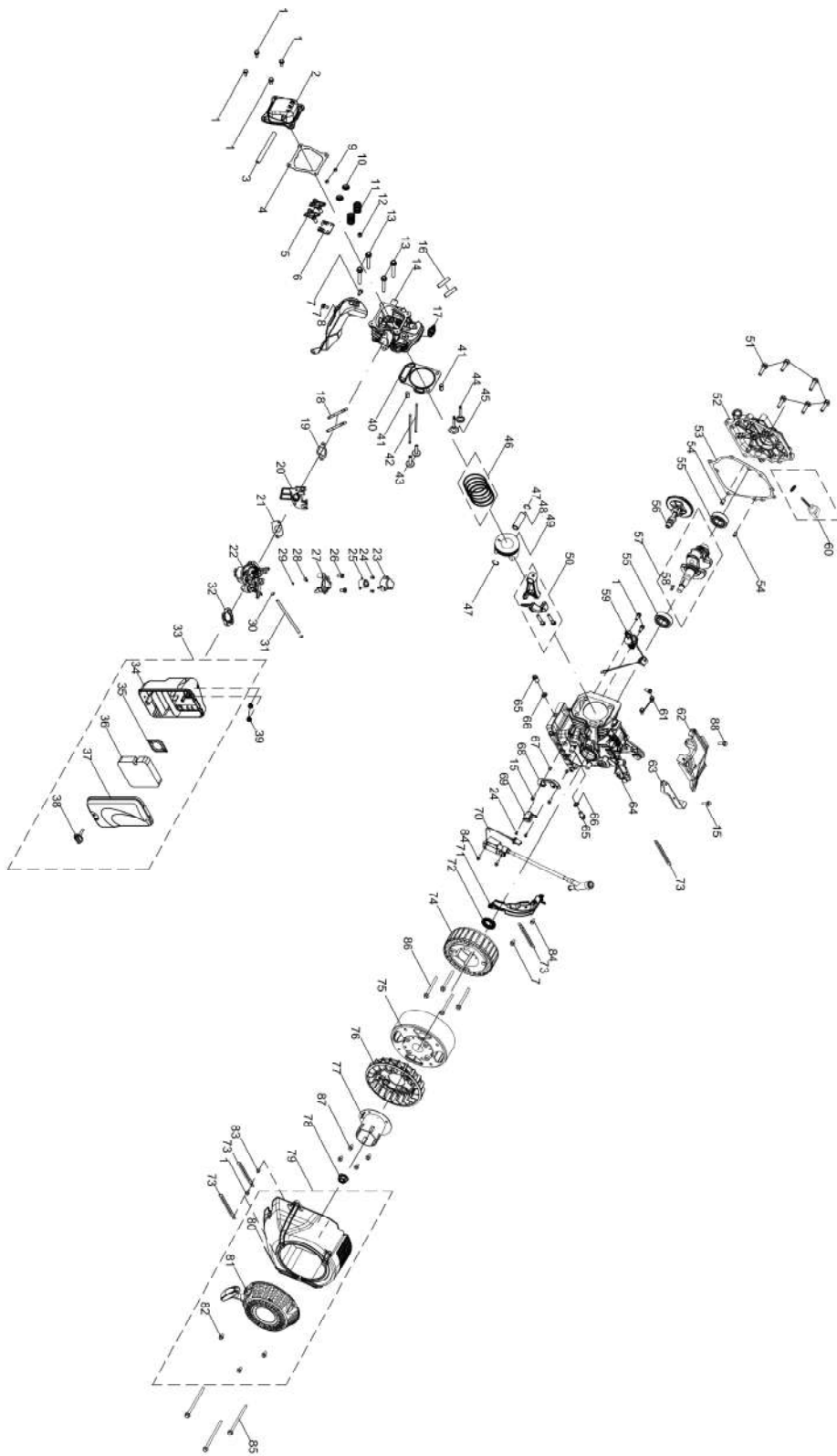

Engine parts list

Item	Stock#	Description	Qty.	Item	Stock#	Description	Qty.
1	100011264-0003	Bolt, M6×16	7	27	100030062	Motor Base	1
2	100056645	Valve Cover	1	28	100033258	Guide Clamp	1
3	100713739	Breather Hose	1	29	100052405	Spring	1
4	100010181	Gasket, Valve Cover	1	30	100005137	Clamp	2
5	100004419	Rocker Arm Assembly	2	31	100017699	Fuel Hose φ4×φ10×320	1
6	100050881	Rocker Arm Base	1	32	100005629	Gasket, Carburetor	1
7	100011260-0005	Bolt, M6×10	3	33	100098952	Air Filter Assembly	1
8	100007083	Shroud	1	34	100099680	Air Filter Base Assembly	1
9	100050896	Valve Locker	4	35	100005078	Air Filter Baffle	1
10	100073758	Valve Spring Seat	2	36	100004771	Air Filter Element	1
11	100713979	Valve Spring	2	37	100087055	Air Filter Cover	1
12	100004599	Intake Valve Seal	1	38	100004949	Bolt	1
13	100002464-0001	Bolt, M8×60	4	39	100011463-0002	Nut, M6	2
14	100079792	Cylinder Head	1	40	100155656	Gasket, Cylinder Head	1
15	100055588-0009	Bolt, M6×20	3	41	100010558	Pin, φ10×16	2
16	100010387	Stud, M8×34	2	42	100077152	Push Rod	2
17	100009376	Spark Plug	1	43	100004262	Tappet	2
18	100061091	Stud, M6×98	2	44	100713981	Exhaust Valve	1
19	100078607	Gasket, Carburetor Insulator	1	45	100713980	Intake Valve	1
20	100122101	Insulator	1	46	100003243	Piston Ring Set	1
21	100078606	Gasket, Carburetor	1	47	100003221	Circlip	2
22	100127490	Carburetor	1	48	100003123	Piston Pin	1
23	100050035	Stepping Motor Cover	1	49	100003086	Piston	1
24	100051029-0002	Screw, M4×6	4	50	100003446	Connecting Rod Assembly	1
25	100093486	Stepping Motor	1	51	100011319-0001	Bolt, M8×32	6
26	100010947-0001	Screw, M4×12	2	52	100128008	Crankcase Cover	1

Item	Stock#	Description	Qty.	Item	Stock#	Description	Qty.
53	100010148	Gasket, Crankcase	1	71	100130948	Lower Shield	1
54	100010550	Pin,φ8×14	2	72	100017644	Oil Seal, φ25×φ41.25×6	1
55	100010761	Bearing, TM6205	2	73	100000655	Clip	4
56	100099599	Camshaft	1	74	100135644	Stator Assembly	1
57	100126476	Crankshaft	1	75	100126953	Rotor	1
58	100010577	Woodruff Key	1	76	100087582	Cooling Fan	1
59	100062919	Oil Sensor	1	77	100087581	Starter Cup	1
60	100004105-0005	Dipstick	1	78	100011459-0003	Nut, M14×1.5	1
61	100011215-0001	Bolt, M6×12	3	79	100130836-0001	Recoil Starter	1
62	100139133	Governor Gear Bracket	1	80	100128650	Blower Housing	1
63	100122098	Muffler Bracket	1	81	100136927	Recoil Starter	1
64	100130838	Crankcase	1	82	100011565-0001	Bolt, M6×10	3
65	100010272	Earth Bolt	2	83	100054365	Bush, φ6.5×φ15×7	1
66	100010459	Washer, φ10×1.5×φ16	2	84	100011266-0004	Bolt, M6×20	3
67	100004232	Bush, φ12×φ6×8	2	85	100011284-0003	Bolt, M6×100	3
68	100122099	Trigger Support	1	86	100011543-0001	Bolt, M6×65	4
69	100146622	Trigger	1	87	100011581-0001	Bolt, M6×14	4
70	100130837	Ignition Coil	1	88	100055589-0009	Bolt, M6×16	1

TWO (2) YEARS LIMITED WARRANTY

PowerSmart is committed to building equipment that will provide years of dependable service. Our warranties are consistent with our commitment and dedication to quality.

TWO (2) YEARS LIMITED WARRANTY OF POWER SMART PRODUCTS FOR HOME USE.

PowerSmart ("Seller") warrants to the original purchaser only, that all PowerSmart consumer power tools will be free from defects in material or workmanship for a period of two (2) years from date of purchase. If the tool(s) is used while providing professional or commercial services, the warranty coverage shall be for a maximum of (90) days.

SELLER'S SOLE OBLIGATION AND YOUR EXCLUSIVE REMEDY under this Two (2) Years Limited Warranty and, to the extent permitted by law, any warranty or condition implied by law, shall be the repair or replacement of parts, without charge, which are defective in material or workmanship and which have not been misused, carelessly handled, or improperly repaired, by person(s) other than an Authorized Seller or Service Center.

Please be aware that normal wear parts are not covered this warranty. This includes drive belts, blades and grass bags. Carburetor issues, and/or other damage found to be the result of stale, contaminated or compromised fuel, are not covered under this limited warranty.

To make a claim under this Limited Warranty, you must return the entire power tool product; transportation prepaid, to PowerSmart. The owner must include a legible copy of the original receipt, which shall list the date of purchase, along with the company's name where the product was purchased.

THIS LIMITED WARRANTY DOES NOT APPLY TO ANY ACCESSORY ITEMS INCLUDED WITH THE TOOL SUCH AS CIRCULAR SAW BLADES OTHER RELATED ITEMS OR TO ANY REPLACEMENT PARTS LISTED UNDER MAINTENANCE.

ANY IMPLIED WARRANTIES SHALL BE LIMITED IN DURATION TO TWO (2) YEARS FROM DATE OF PURCHASE. SOME STATES IN THE U.S. AND SOME CANADIAN PROVINCES DO NOT ALLOW LIMITATIONS ON HOW LONG AN IMPLIED WARRANTY LASTS, SO THE ABOVE LIMITATION MAY NOT APPLY TO YOU.

IN NO EVENT SHALL SELLER BE LIABLE FOR ANY INCIDENTAL OR CONSEQUENTIAL DAMAGES (INCLUDING BUT NOT LIMITED TO LIABILITY FOR LOSS OF PROFITS) ARISING FROM THE SALE OR USE OF THIS PRODUCT. SOME STATES IN THE U.S. AND SOME CANADIAN PROVINCES DO NOT ALLOW THE EXCLUSION OR LIMITATION OF INCIDENTAL OR CONSEQUENTIAL DAMAGES, SO THE ABOVE LIMITATION OR EXCLUSION MAY NOT APPLY TO YOU.

THIS LIMITED WARRANTY GIVES YOU SPECIFIC LEGAL RIGHTS, AND YOU MAY ALSO HAVE OTHER RIGHTS WHICH VARY FROM STATE TO STATE IN THE U.S., PROVINCE TO PROVINCE IN CANADA AND FROM COUNTRY TO COUNTRY.

For questions, comments, technical assistance or to order repair

1-800-791-9458 (M-F 9am – 5pm EST) Email:

support@amerisuninc.com

PLEASE SAVE ALL OF YOUR ORIGINAL RECEIPTS. THIS WARRANTY IS VOID WITHOUT THEM.