

P30L LCD 30A Solar Charge Controller

CHC-LCD-30

User's Manual

Table of Contents

1	Introduction.....	3
1.1	Features.....	3
1.2	Safety Information.....	3
1.3	Specifications.....	4
1.3.1	Electrical Specifications.....	4
1.3.2	Physical Specifications.....	4
2	Installation.....	4
2.1	Electrostatic (ESD) Precautions.....	4
2.2	Mounting.....	4
2.3	Connections.....	5
2.4	Parallel Connections.....	7
3	Operation.....	7
3.1	Button Definitions.....	8
3.2	LCD Graphic Indicators.....	8
3.3	LCD Interface Cycle.....	9
3.4	Interface Definitions.....	9
3.4.1	Battery Voltage – MAIN Interface.....	9
3.4.2	Battery Temperature Interface.....	10
3.4.3	PV – Solar Panel Output Current Interface.....	10
3.4.4	Load Current Interface.....	10
3.4.5	PV – Solar Panel Generated Charge Interface.....	10
3.4.6	Load Consumed Charge Interface.....	11
3.4.7	Low Voltage Disconnect (LVD) Parameter Interface.....	11
3.4.8	Low Voltage Reconnect (LVR) Parameter Interface.....	11
3.4.9	Over Voltage Disconnect (OVD) – Float Parameter Interface.....	12
3.4.10	Load Mode – Timed Control Interface.....	12
3.5	Error Conditions.....	13
3.5.1	Low Voltage Protection.....	13
3.5.2	Overload Protection.....	13
3.5.3	Short-Circuit Protection.....	13
3.5.4	Solar Panel Connection.....	14
3.5.5	Load In-Rush.....	14
4	Application.....	14
4.1	Wire Gauge Reference.....	14
4.1.1	Wire Thickness.....	14
5	Troubleshooting And Support.....	14
5.1	Maintenance & Care.....	14
5.2	Troubleshooting.....	14
5.3	Support.....	15
5.4	Warranty.....	15
5.4.1	Restrictions.....	15
5.4.2	Warranty Claims & Return Procedures.....	15
5.4.3	Disclaimer.....	16
5.4.4	Limitation of Liability.....	16

1 INTRODUCTION

The WindyNation P30L Solar Charge Controller provides an intelligent multifunctional charging and power management solution for the solar charging of 12 and 24 volt battery systems. Operation is conveniently presented and parameters are controlled via a customized LCD display screen interface.

The controller features an automatic 12V or 24V DC detect function that will identify the battery voltage upon initial battery connection and uses Pulse-Width Modulation (PWM) allowing for a highly efficient and battery-friendly charge control. An external temperature sensor provides software controlled charge compensation that accurately adjusts the over-discharge and over-charge voltages to maximize your batteries' life.

Built in protection includes overload, short circuit, reverse polarity, lightning/surge, PV panel reverse current, over charging, and discharging protection. In the event of a short circuit or overload event, the system will be protected and remain undamaged.

The enclosure is made of durable plastic with visual LCD graphic symbols to provide status indications of charge, battery status, and system faults.

Read this manual carefully before installing or using the controller and keep it for future reference.

1.1 FEATURES

- ✓ Compact size is easy to mount on wall or panel.
- ✓ Visual LCD display
- ✓ User adjustable operation
- ✓ Intelligent PWM Charging Mode
- ✓ Automatic battery charging temperature compensation
- ✓ User settable charging & discharging voltage parameters
- ✓ User settable working modes of loads
- ✓ Accumulative function of charging & discharging AH
- ✓ Protection for battery bank discharging
- ✓ Protection for battery low voltage
- ✓ Battery reverse polarity protection
- ✓ Delayed auto restart after overloading protection
- ✓ Charge controller maintains batteries and extends battery life
- ✓ Convenient screw terminals for wiring
- ✓ Separate connections for PV panel, battery, and load
- ✓ Built-in overload and short circuit protection
- ✓ User selectable on, off, and time modes
- ✓ Wide operating temperature range -10°C to +60°C (14°F to +140°F)

1.2 SAFETY INFORMATION

Please read the installation and operating instructions carefully prior to use. Pay special attention to the **IMPORTANT** and **WARNING** statements in the manual.

WARNING:

Never install during a lightning storm or where unsafe voltages are present.

Solar panels produce power when exposed to light. Shade solar panels whenever solar panel wires are exposed.

Do not use with equipment that exceeds the rated power for this device.

1.3 SPECIFICATIONS

1.3.1 Electrical Specifications

Parameter	CHC-LCD-30
Rated Charge Current	30 Amps
Rated Load Current	30 Amps
Typical Idle Consumption	At idle < 5mA
Maximum Solar Input Voltage	48V DC
Rated Working Voltage	12V DC or 24V DC Battery Systems
Float Charging Voltage (adjustable)	12.8V-15V DC / 25.6V-30V DC Default: 13.7V
Low Voltage Protection (adjustable)	9.0V-12.3V DC / 18.0V-24.6V DC Default: 10.7V
Low Voltage Recovery (adjustable)	11.0V-13.4V DC / 22.0V-26.8V DC Default: 12.6V
No Load Loss	≤30mA
Loop Voltage Drop	≤170mV
Temperature Compensation	-4.0 mV/Cell/°C

1.3.2 Physical Specifications

Parameter	Value
Dimension (H x W x D)	3.54" (90mm) x 7.40" (188mm) x 1.89" (48mm)
Unit Weight	12.7 oz. (360g)
Operating Temperature	14°F to 140°F (-10°C to 60°C)
Operating Humidity	≤90% relative humidity (non-condensing)
Wire Size	Up to 16mm ² (7AWG)

2 INSTALLATION

- Insure all terminating connections are clean and tight to prevent arcing and overheating.
- The controller must be installed in an area that satisfies all of the following conditions:
 1. Dry: Avoid any location where water can contact the controller
 2. Cool: Ambient air temperature between 30°F and 105°F (0°C and 40°C)
 3. Ventilated: Allow at least 4 in (10 cm) of clearance above and below and at least 1 in (25 mm) on each side for proper air flow.

2.1 ELECTROSTATIC (ESD) PRECAUTIONS

All electronic circuits may be damaged by static electricity. To minimize the likelihood of electrostatic damage, discharge yourself by touching an electrical ground (e.g.: copper pipe) prior to handling the unit and avoid touching components on the circuit boards. The risk of electrostatic damage is highest when relative humidity is below 40%.

2.2 MOUNTING

Mounting is optional; however, the environment must be dry and protected from water.

1. The controller can be mounted on a vertical or horizontal surface. If mounted vertically, the unit should be oriented such that neither end is at the top so foreign material cannot settle into the unit.
2. Install four user-supplied fasteners through the four mounting slots and into the mounting surface.
3. Tighten all the fasteners to ensure the controller cannot slide in any direction.

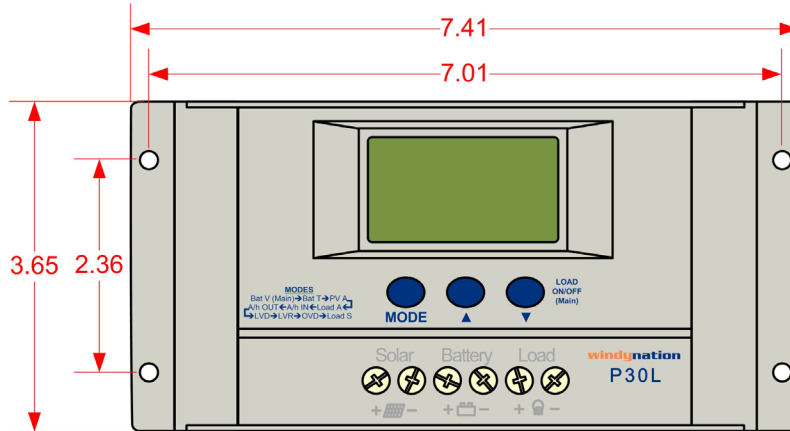

IMPORTANT: For best results, mount the charge controller and batteries as close to the panels as practical.

2.3 CONNECTIONS

WARNING: Loose connectors result in excessive voltage drop and may over heat wires, which can cause the wire insulation to melt. This can cause electrical fires. Verify all connections are secure and have no voltage drop.

IMPORTANT: The NEC requires that the wires carrying the system current never exceed 80% of the conductor's current rating (sizing recommendations are located in Section 4).

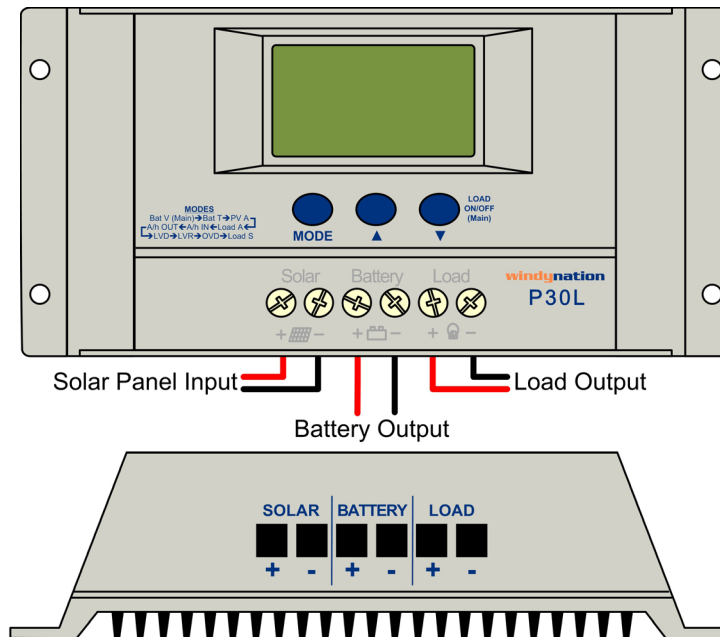

IMPORTANT: The screw-down terminals on the charge controller accept 7~26AWG wire.

IMPORTANT: Strip the wire ends approximately 0.3" (7.6mm) before connecting to the charge controller. Use caution when handling the stripped wires to avoid electric shock.

1) Connect the Battery

Connect the charge controller to the battery **BEFORE** connecting the solar panels to the charge controller. Insert the battery wiring to the **BATTERY** terminals on the front of the charge controller and tighten the terminals from the top of the controller using a screwdriver to ensure a good connection is made. Be sure to note the polarity of each terminal; the charge controller self-protection feature will prevent damage from

reverse polarity connections, but the charge controller will not function until the battery is connected properly. **A 40 amp fuse needs to be placed in the positive wire connecting the charge controller to the battery.**

2) Connect the Solar Panel (PV) Array

Insert the solar panel wiring to the SOLAR terminals on the front of the charge controller and tighten the terminals from the top of the controller using a screwdriver to ensure a good connection is made. Be sure to note the polarity of each terminal; the charge controller self-protection feature will prevent damage from reverse polarity connections, but the charge controller will not function until the PV Array is connected properly. **A 30 amp in-line fuse needs to be placed in the positive wire connecting the charge controller to the solar panel(s).**

WARNING: High voltages may be present on the solar panel output wiring. Solar panels produce electricity when exposed to light. Make sure the solar panels are placed in the shade and are NOT in direct sunlight. Use caution and avoid touching any conductors in the system circuit to avoid electric shock.

3) Connect the Load (Optional)

This step is optional and only required if you want to power a small (less than 30A) DC load through the charge controller. Connect the wires from the appliance to the LOAD terminals on the front of the charge controller and tighten the terminals from the top of the controller using a screwdriver to ensure a good connection is made. Be sure to note the polarity of each terminal; the charge controller self-protection feature will prevent damage from reverse polarity connections, but the charge controller will not function until the load is connected properly. **A 30 amp fuse needs to be placed in the positive wire connecting the charge controller to the load.**

4) Connect the Battery Temperature Sensor – BTS (Optional)

The charge voltage required by batteries changes with battery temperature. Temperature compensation of the charge voltage enhances battery performance and life, and decreases battery maintenance. Automatic temperature compensation can be provided through use of the optional battery temperature sensor (included). The Temperature compensation is $-4.0 \text{ mV/Cell/}^\circ\text{C}$.

- 1) Plug the provided BTS cable into the socket labeled “BTS” located on the left side of the controller as shown below.

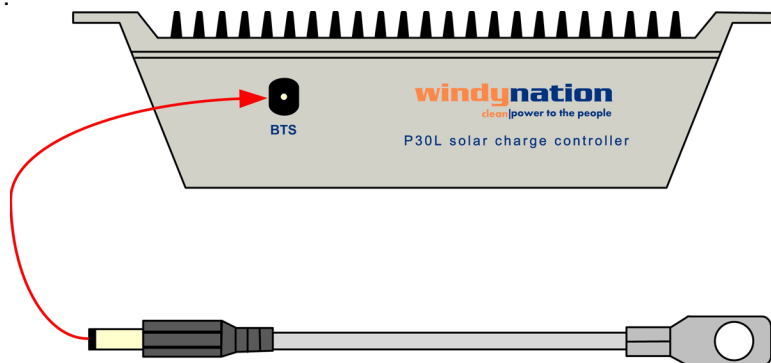

- 2) Secure the ring terminal on the BTS directly to any side of the battery to be monitored, below the electrolyte level as shown below. When multiple batteries are used, it is best to place the sensor between batteries and place the batteries in an insulated box to reduce the influence of the ambient temperature outside the battery enclosure.

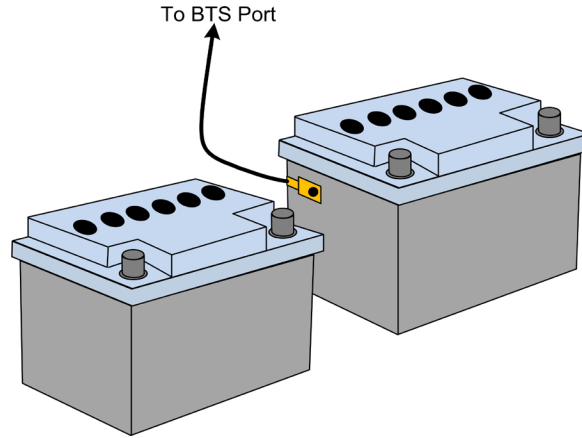

CAUTION: High power electrical systems pose dangers and it is the user's responsibility to be familiar with these dangers and take any necessary action to ensure safe use. Shorting a battery or connecting your controller to a battery can supply huge currents and have serious consequences including explosions, causing fire, damage to equipment, and personal injury including death.

2.4 PARALLEL CONNECTIONS

Multiple controllers can be installed in parallel on the same battery bank to achieve higher charging current. For example, connecting two units in parallel can allow for 60 amps of charging current, and connecting three units in parallel can allow for up to 90 amps of charging current.

Additional parallel controllers can also be added in the future, however, each Controller must have its own PV array as shown below.

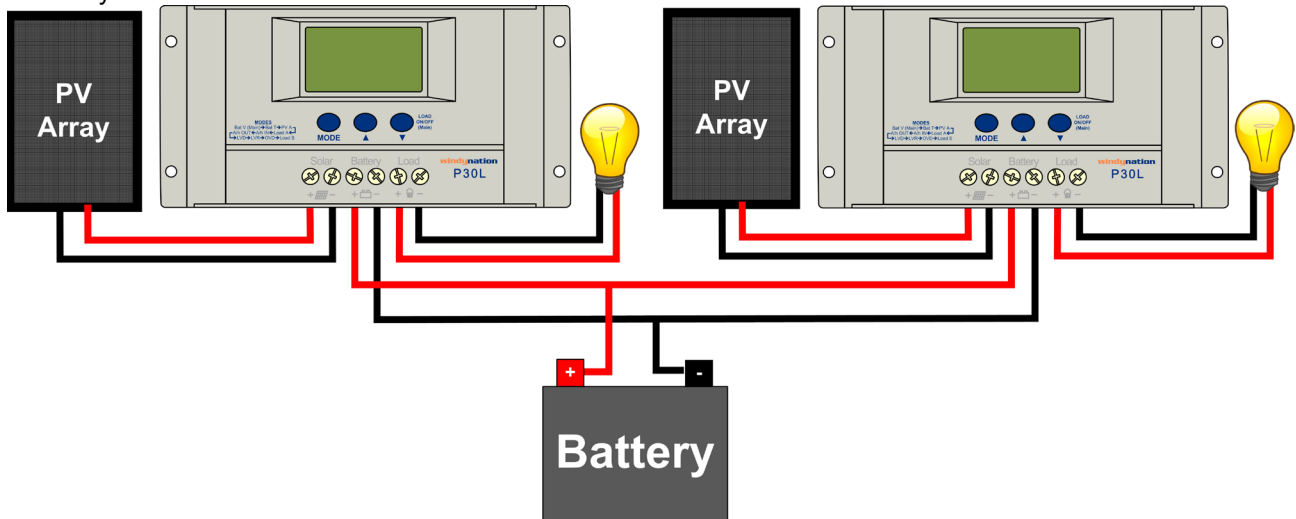



3 OPERATION

Once the controller is properly connected, the main display interface will appear in the LCD and the current battery voltage will be displayed. Press the 'UP' or 'DOWN' buttons to cycle through the ten different interfaces available on the P30L controller. The cycle pattern of the interfaces is presented in Section 3.3 and the definition of each interface is presented in Section 3.4. Some of the parameters presented can be reset. In order to reset an eligible interface, press the 'MODE' button for at least 5 seconds and the parameter should reset. Similarly, some parameters are user configurable. In order to set an eligible interface, press the 'MODE' button for at least 5 seconds. The number on the interface will start to blink or flicker and the parameter value can be adjusted using the 'UP' or 'DOWN' buttons. **Once the desired value**

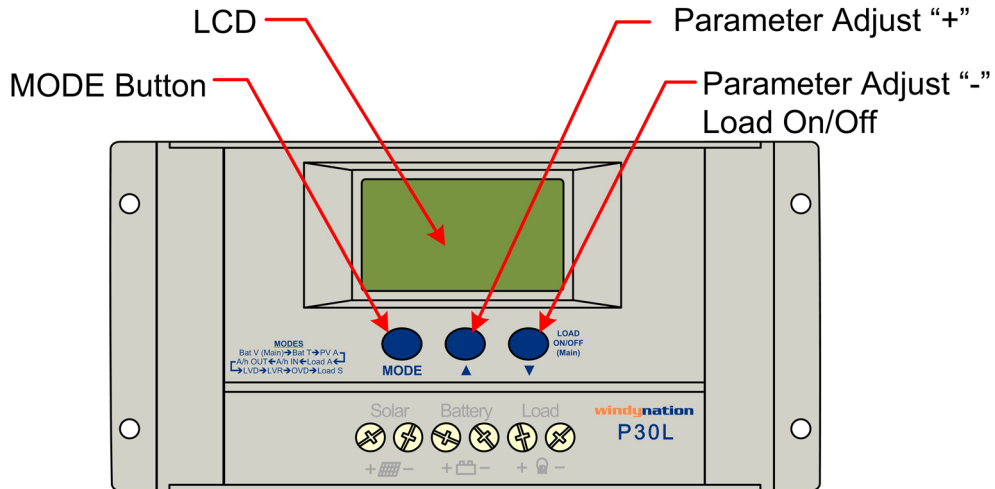







is set, press the mode button for over 5 seconds to exit the setting interface, and the number will stop blinking or flickering.









3.1 BUTTON DEFINITIONS

Button	Name	Description
	MODE	Toggles the active LCD interface in a circular motion as defined in Sec 3.1.3
	UP	Positive (+) parameter adjustments. Holding button for >5 seconds will reset parameters.
	DOWN / LOAD	Negative (-) parameter adjustments. At "MAIN" interface screen, will turn the LOAD on and off.

3.2 LCD GRAPHIC INDICATORS

LCD Symbol	Description
	Stop power supply to LOADs
	Supply power to LOADs, No current drawn from Load
	Supply power to LOADs, Load is drawing current
	Load Icon
	Solar Panel Icon
	Battery Icon
	Load Light Control Icon
	Load Timing Control Icon

	Stop Charge to Battery
	Full Charging to Battery
	Float Charging to Battery
	Normal Working Condition
	Error/Abnormal Working Condition
	Battery Capacity

3.3 LCD INTERFACE CYCLE

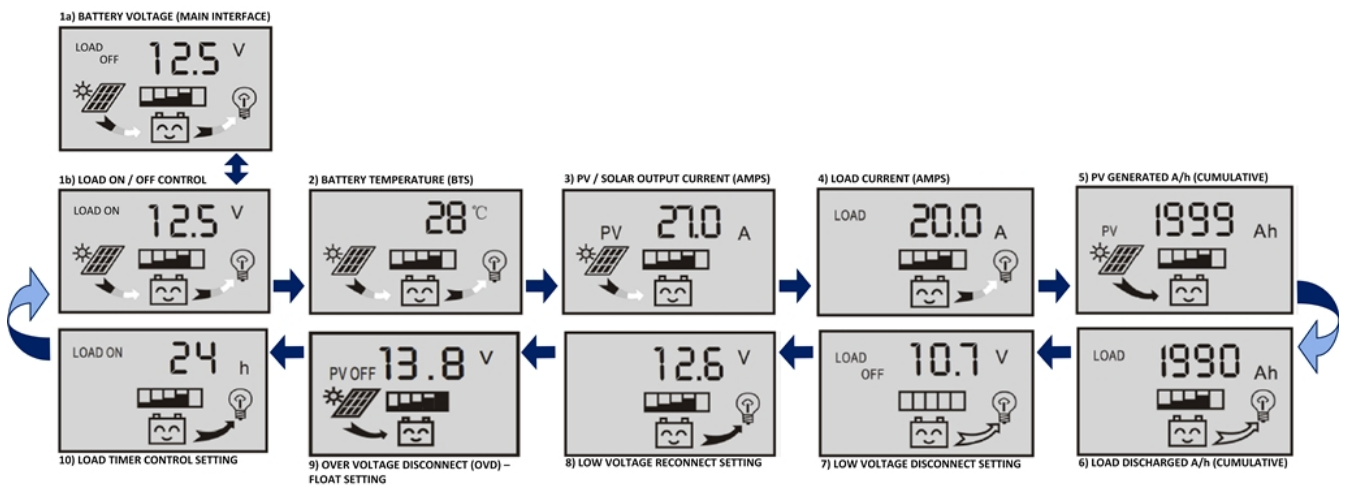

3.4 INTERFACE DEFINITIONS

The P30L has ten different graphical interfaces. Each interface contains different information. The Main Interface displays the current state of the Load, PV charging, Load discharging, battery capacity, and overall system working condition as shown below.

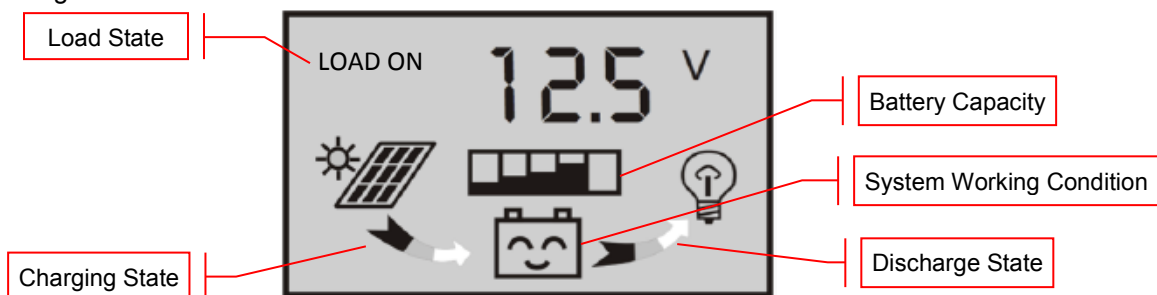

3.4.1 Battery Voltage – MAIN Interface

This is the MAIN Interface and the displayed number is the present battery voltage (displayed in Volts).

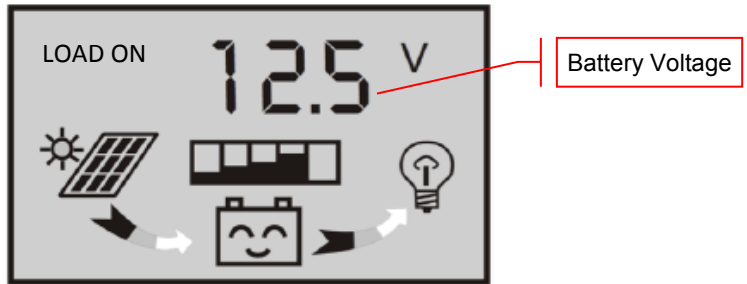

By pressing the 'DOWN / LOAD' button from this interface, you can turn the load ON or OFF.
NOTE: The Load on/off function is not available in any other interface.

3.4.2 Battery Temperature Interface

The value displayed in this interface is the temperature at the Battery Temperature Sensor (BTS) as described in Section 2.3 (displayed in degrees Celsius). The temperature is used for the temperature compensation of battery charging.

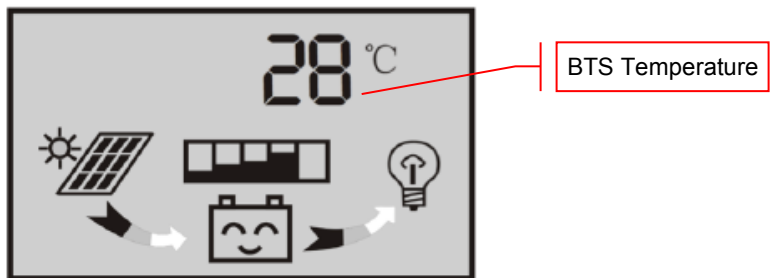

3.4.3 PV – Solar Panel Output Current Interface

The value displayed in this interface is the input current to the battery from the controller; i.e.: the current being generated by the solar panels (displayed in Amps).

NOTE: The amount of current sent to the battery depends on the battery State of Charge (SOC)

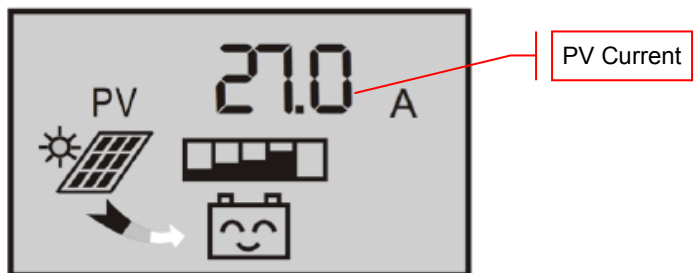

3.4.4 Load Current Interface

The value displayed in this interface is the output current from the controller to the load; i.e.: the current being consumed by the load (displayed in Amps).

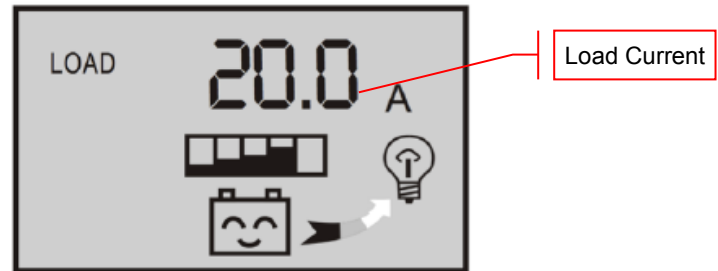

3.4.5 PV – Solar Panel Generated Charge Interface

The value displayed in this interface is the cumulative, generated charge of the solar panels sent from the controller to the battery, displayed in Amp-hours (Ah). For example, if 5 amps is supplied to the battery from the solar panel(s) for 1 hour, then 5 Ah will be displayed on the LCD.

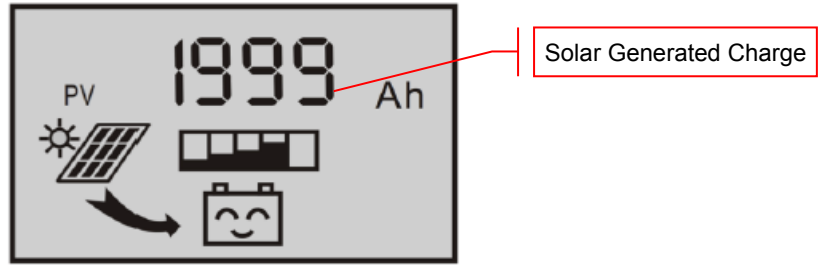

NOTE: Press the 'MODE' button for over 5 seconds to clear/reset the cumulative, generating charge (Ah).

3.4.6 Load Consumed Charge Interface

The value displayed in this interface is the cumulative, consumed charge of the Load displayed in Amp-hours (Ah).

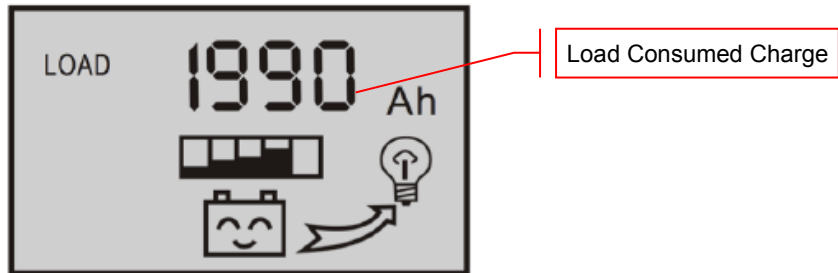

NOTE: Press the 'MODE' button for over 5 seconds to clear/reset the cumulative, consumed charge (Ah).

3.4.7 Low Voltage Disconnect (LVD) Parameter Interface

The value displayed in this interface is the Low Voltage Disconnect protection voltage set for the controller. If the battery voltage is lower than the set protection voltage, the controller will automatically disconnect the load to prevent the battery from over-discharging. The Low Voltage Disconnect is user settable.

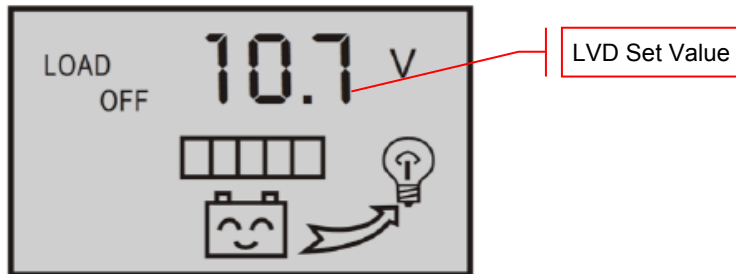

NOTE: To change the LVD voltage, press the 'MODE' button for over 5 seconds until the number starts to blink / flicker. The controller will enter the adjustable mode, where you can use the 'UP' and 'DOWN' buttons to adjust the parameter. After the value has been set, press the 'MODE' button for over 5 seconds to exit the adjustable mode and store the setting.

3.4.8 Low Voltage Reconnect (LVR) Parameter Interface

The value displayed in this interface is the Low Voltage Reconnect voltage set for the controller. After the controller enters into a low voltage protection state (Section 3.4.7), and the battery voltage recovers to the value set for the Low Voltage Reconnect, the controller will reconnect the load automatically.

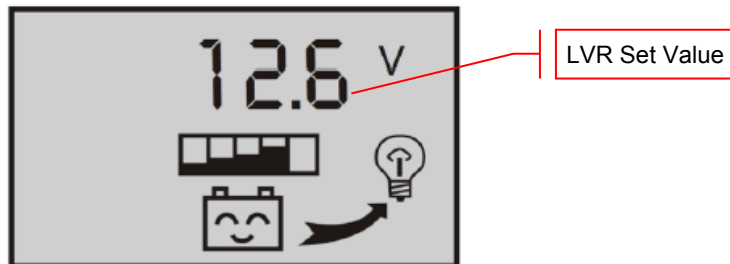

NOTE: To change the LVR voltage, press the 'MODE' button for over 5 seconds until the number starts to blink / flicker. The controller will enter the adjustable mode, where you can use the 'UP' and 'DOWN' buttons

to adjust the parameter. After the value has been set, press the 'MODE' button for over 5 seconds to exit the adjustable mode and store the setting.

3.4.9 Over Voltage Disconnect (OVD) – Float Parameter Interface

The value displayed in this interface is the value at which the charge controller will stop charging the battery. When the battery voltage reaches this voltage, the controller will disconnect the charging solar panel(s) to prevent the battery from overcharging. After the battery voltage drops below the Over Voltage Disconnect value, the controller will reconnect the charging solar panel(s).

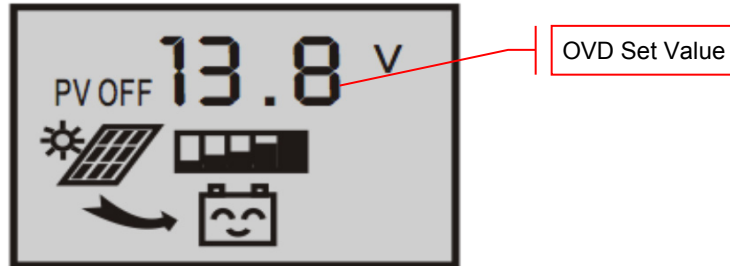

NOTE: To change the OVD value, press the 'MODE' button for over 5 seconds until the number starts to blink / flicker. The controller will enter the adjustable mode, where you can use the 'UP' and 'DOWN' buttons to adjust the parameter. After the value has been set, press the 'MODE' button for over 5 seconds to exit the adjustable mode and store the setting.

3.4.10 Load Mode – Timed Control Interface

The P30L charge controller has a mode setting function to set specific operation parameters. It is preset to the factory default of normal control (24 hours). In 'Normal' mode, the load will draw from the battery at all times, and the PV panel will charge the battery when sunlight is available. It is also possible to have the load remain on for a set duration, and when that set time period has elapsed, the load will switch off. The duration setting is available in increments of 1 hour and 1-23 hour delays can be selected.

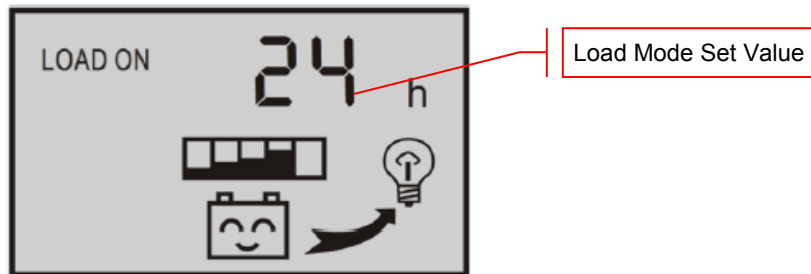

NOTE: To change the Load Control value, press the 'MODE' button for over 5 seconds until the number starts to blink / flicker. The controller will enter the adjustable mode, where you can use the 'UP' and 'DOWN' buttons to adjust the parameter. After the value has been set, press the 'MODE' button for over 5 seconds to exit the adjustable mode and store the setting.

Value	Mode	Function
24h	Normal (Default)	Load is supplied continuous power.
1h – 23h	Timed Control	Load is supplied power at nighttime and continues working for the specified duration (in hours). For example, if the Load Control Value is set to 2h, then the load will be turned on at night time and remain on for a period of 2 hours.
0h	Light Control	Load starts to supply power after dark and stops at dawn (sunrise).

IMPORTANT: There is a 10 minute delay before turning on the load in order to make sure it is really dark and not a passing cloud etc.

3.5 ERROR CONDITIONS

3.5.1 Low Voltage Protection

If the battery voltage is lower than the protection voltage (Section 3.4.7), the controller will enter the low voltage protection state and the load will be disconnected. The use of solar panels or an alternate charger is required to charge the battery to the recovery level (Section 3.4.8). The controller will enter into the normal working state and power will be supplied to the load once the battery voltage exceeds the Low Voltage Protection voltage.

When in Low Voltage Protection State, the LCD will look similar to the image below.



3.5.2 Overload Protection

If the Load is drawing a current 1.2 times the rated current of the controller for three (3) seconds or more, the controller will enter into an Overload Protection State. When in this state, any loads applied will need to be removed one by one until power is again supplied to the loads. The controller will supply power to the loads automatically within seconds of being within an acceptable level or you may repeatedly press the 'DOWN' button to recover the power supply. However, if the load is not at an acceptable level, the controller will go back into the protection state.

When in Overload Protection State, the LCD will look similar to the image below and the Load Icon will blink or flicker.

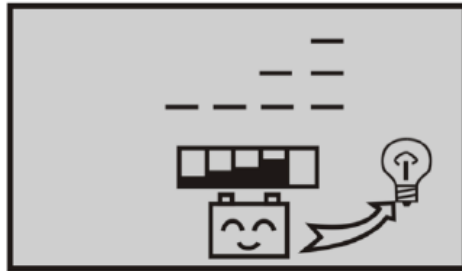

3.5.3 Short-Circuit Protection

If a shorted circuit is detected in the Load, the controller will enter into a short-circuit protection state. When in this state, check the loads and/or connecting cables for any damage or short-circuiting. Once the problem has been identified and corrected, repeatedly press the 'DOWN' button to recover the power supply.

When in Short-Circuit Protection State, the LCD will look similar to the image below and the Load Icon will blink or flicker.

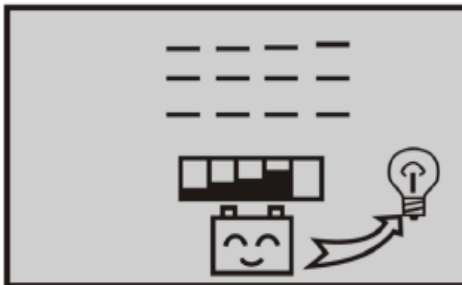

3.5.4 Solar Panel Connection

If the Solar Panel Icon  is blinking or flickering, it means the controller does not detect the existence of solar panels. Check that all the connections with the solar panels are making good contact and are in good condition. Check the connection terminals on the controller for any open-circuit conditions.

3.5.5 Load In-Rush

If the Load Icon  is blinking or flickering when you turn on the load, it means the starting in-rush current for the load is more than twice that of the rated working current. Please lower or remove the load and restart the controller.

4 APPLICATION

4.1 WIRE GAUGE REFERENCE

4.1.1 Wire Thickness

AWG	Diameter inches (mm)	Ohms per 1000ft	Break Force	Square mm2
16	0.051 (1.29)	4.016	75 lbs	1.30
14	0.064 (1.63)	2.525	119 lbs	2.08
12	0.081 (2.05)	1.588	197 lbs	3.30
10	0.102 (2.59)	0.999	314 lbs	5.26
8	0.129 (3.26)	0.628	480 lbs	8.30
6	0.162 (4.11)	0.395	760 lbs	13.30
4	0.204 (5.19)	0.249	1210 lbs	21.15
2	0.258 (6.54)	0.156	1930 lbs	33.62
1	0.289 (7.35)	0.124	2430 lbs	42.41
0 (1/0)	0.325 (8.25)	0.098	3060 lbs	53.49
00 (2/0)	0.365 (9.27)	0.078	3860 lbs	67.43
000 (3/0)	0.410 (10.4)	0.062	4860 lbs	85.01
0000 (4/0)	0.460 (11.68)	0.049	6120 lbs	107.22

5 TROUBLESHOOTING AND SUPPORT

The Controller requires minimal care. It is recommended to inspect all the connections at least two times per year for insulation damage or corrosion and to ensure all connections are tight and secure.

5.1 MAINTENANCE & CARE

- Clean the area around the controller of any dirt or debris with a cloth.
- Tighten the screws on the terminals. Inspect for loose, broken, or burnt wire connections.
- Inspect batteries for cracked or bulging cases and corroded terminals.
- Make sure the PV array is clean and remove any debris.

5.2 TROUBLESHOOTING

Problem	Possible Remedies
---------	-------------------

<p>The charge to battery LCD indicator doesn't appear when the solar panel is exposed to sunlight.</p>	<ol style="list-style-type: none"> 1. Check if the solar panel cables are connected properly. 2. Check to make sure the correct battery is being used. 3. Check all wiring connections to make sure they are in their designated locations and make sure that there are no loose connections. 4. Measure the PV array open-circuit voltage and confirm normal limits. 5. Measure the PV voltage and the battery voltage at the controller terminals. <ol style="list-style-type: none"> a. If voltage at terminals is within specifications, PV array is charging battery. b. If the PV voltage is within specifications to the open circuit voltage rating of the panels, but the battery voltage is low, the charge controller may not be charging the battery and it may be damaged.
<p>The 'LOAD ON' indicator is on but there is no power output.</p>	<ol style="list-style-type: none"> 1. Load open circuit. 2. Check cables and connections and any other load switches. 3. Over discharge of the battery. The controller will resume normal operation after the battery has finished charging.

5.3 SUPPORT

If you are experiencing technical problems, and cannot find a solution in this manual, you can contact Windy Nation Inc. for further assistance.

- Call: (805) 323-6445
- Email: support@windynation.com
- Write: 1404 Fleet Ave, Ventura, CA 93003

For challenging issues or to just ask a question, consider using our FREE Community Forums! Consult our community of DIY'ers for fast answers to all your questions.

Post on our Forums: <http://www.windynation.com/community/>

5.4 WARRANTY

Windy Nation warrants that the Power Controller (the "Product"), will be free from manufacturing defects in materials and workmanship under normal authorized use consistent with product instructions for a period of one (1) year from the date the original purchaser ("Customer") receives the Product (the "Warranty Period"). This warranty extends only to the original purchaser. The Customer's sole and exclusive remedy and the entire liability of Windy Nation, its suppliers and affiliates for breach of the warranty is, at Windy Nation's option, either (i) to replace the Product (or defective component part(s)) with a new or reconditioned Product (or component part(s)); (ii) to repair the reported problem; or (iii) to refund the purchase price of the Product. Repaired or replaced products are warranted for the remainder of the original warranty period only. No employee, agent, dealer or other person is authorized to give any warranties on behalf of Windy Nation not expressly set forth in this limited warranty.

5.4.1 Restrictions

No warranty will apply if the Product (i) has been altered or modified except by Windy Nation; (ii) has not been installed, operated, repaired, or maintained in accordance with instructions supplied by Windy Nation; (iii) has been subjected to abnormal physical, thermal or electrical stress, misuse, negligence, or accident. If Windy Nation determines that the problem with the Product is not due to a manufacturing defect in Windy Nation's workmanship or materials, or otherwise does not qualify for warranty repair, then the Customer will be responsible for the costs of all necessary repairs and expenses incurred by Windy Nation.

5.4.2 Warranty Claims & Return Procedures

To be eligible for service under this warranty, the Customer must submit a service request within the Warranty Period by contacting Windy Nation in writing or via telephone and obtaining a Returned Materials Authorization ("RMA") number. This RMA must be obtained before returning any product under this warranty. Notification must include a description of the alleged defect, the manner in which the Product was used, the

serial number (if applicable), and the original purchase date in addition to the name, address, and telephone number of the Customer. Within five (5) business days of the date of notification, Windy Nation will provide the Customer with an RMA number and the location to which the Customer must return the defective Product. Any Product returned for warranty service shall be shipped at the expense and risk of the Customer. The Customer must return the entire Product kit (or, if authorized by Windy Nation, the defective component parts), within fifteen (15) days after issuance of the RMA number. Windy Nation will be under no obligation to accept any returned Product that does not have a valid RMA number. Customer's failure to return the Product within fifteen (15) days of its receipt of an RMA number may result in cancellation of the RMA. All parts that Windy Nation replaces shall become Windy Nation's property on the date Windy Nation ships the repaired Product or part back to the Customer. Windy Nation will use all reasonable efforts within thirty (30) days of receipt of the defective Product to repair or replace such Product. If a warranty claim is invalid for any reason, the Customer will be charged at Windy Nation's then-current rates for services performed and will be charged for all necessary repairs and expense incurred by Windy Nation. If Windy Nation determines that a warranty claim is valid, it will ship the repaired or replaced Product to Customer at Windy Nation's cost.

5.4.3 Disclaimer

EXCEPT FOR THE EXPRESS LIMITED WARRANTY SET FORTH IN THE PREVIOUS PARAGRAPH, WINDY NATION DISCLAIMS ALL WARRANTIES, EXPRESS, IMPLIED AND STATUTORY INCLUDING, WITHOUT LIMITATION, THE IMPLIED WARRANTIES OF MERCHANTABILITY AND FITNESS FOR A PARTICULAR PURPOSE WITH RESPECT TO ANY PRODUCTS PROVIDED BY WINDY NATION. NO ORAL OR WRITTEN INFORMATION OR ADVICE GIVEN BY WINDY NATION, ITS DEALERS, DISTRIBUTORS, AGENTS OR EMPLOYEES SHALL IN ANY WAY INCREASE THE SCOPE OF THIS WARRANTY. WINDY NATION DOES NOT WARRANT THAT THE QUALITY OR PERFORMANCE OF THE PRODUCTS WILL MEET YOUR REQUIREMENTS OR THAT YOU WILL BE ABLE TO ACHIEVE ANY PARTICULAR RESULTS FROM USE OR MODIFICATION OF THE PRODUCTS.

Some jurisdictions do not allow the limitation or exclusion of implied warranties or how long an implied warranty may last, so the above limitations may not apply to you. In any such jurisdiction, the warranty shall be limited to the minimum warranty and period required by law.

WINDY NATION EXPRESSLY DISCLAIMS ALL LIABILITY FOR BODILY INJURIES OR DEATH THAT MAY OCCUR, DIRECTLY OR INDIRECTLY, BY USE OF THE PRODUCT BY ANY PERSON.

5.4.4 Limitation of Liability

UNDER NO CIRCUMSTANCES WILL WINDY NATION OR ITS AFFILIATES OR SUPPLIERS BE LIABLE OR RESPONSIBLE FOR ANY LOSS OF USE, INTERRUPTION OF BUSINESS, LOST PROFITS, LOST DATA, OR INDIRECT, SPECIAL, INCIDENTAL, OR CONSEQUENTIAL DAMAGES OF ANY KIND REGARDLESS OF THE FORM OF ACTION, WHETHER IN CONTRACT, TORT (INCLUDING NEGLIGENCE), STRICT LIABILITY OR OTHERWISE, EVEN IF WINDY NATION OR ITS AFFILIATE OR SUPPLIER HAS BEEN ADVISED OF THE POSSIBILITY OF SUCH DAMAGE.

Some states do not allow the exclusion or limitation of incidental or consequential damages, so these limitations may not apply to you. Neither Windy Nation nor its affiliates or suppliers will be held liable or responsible for any damage or loss to any items or products connected to, powered by or otherwise attached to the Product. The total cumulative liability to Customer, from all causes of action and all theories of liability, will be limited to and will not exceed the purchase price of the Product paid by Customer. This warranty gives the Customer specific legal rights and the Customer may also have other legal rights that vary from state to state.