

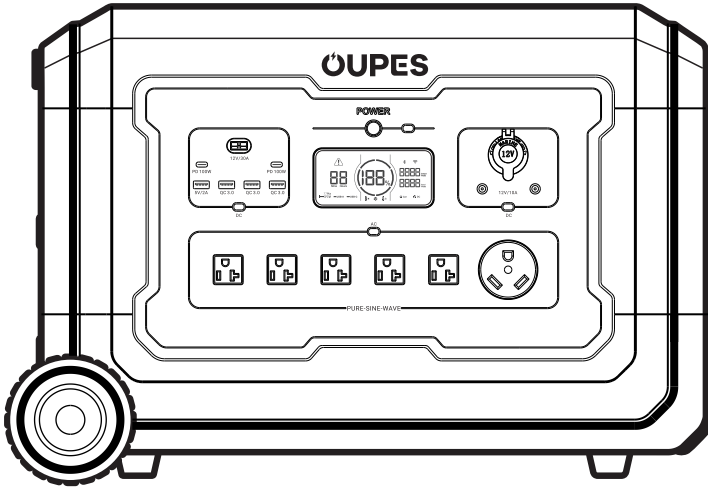

3600W PORTABLE POWER STATION



MEGA 3

User Manual

Content

Disclaimer	1
OUPES APP	2
Sign up and log in	2
Sign up	2
Log in	3
Log in by third-party account	3
Connection setup	3-8
Bluetooth connection	7
Device's Wi-Fi hotspot connection	8
IoT connection	8
Device Control and Upgrade	8-9
Device Control	8
Firmware upgrade	8
Personal Settings and More	10
Modify avatar and nickname	10
Change Password	10
Product List	10
Product Description	11-14
Parameter Specifications	11-12
Function Description	13-14

LCD Screen Description	14
Instructions for use	14-16
Recharge Methods	16-21
AC Charging	16-17
Solar Charging	18-19
Car Charging	19
Power Pack Charging	20-21
Other Functions	21-23
EPS	21-22
Frequency Switching	22
Disconnection switch	23
FAQ	24-25
Fault Code and Trouble Shooting	26-27
Storage & Maintenance	28

Disclaimer

Please read and fully understand this product user manual before use. And keep it well for future reference. If not use this product correctly, you would cause serious injury to yourself or others, or result in product damage and property damage. Once you use this product, you are deemed to have understood, recognized and accepted all terms and content of this user manual. You are solely responsible for your actions and all consequences arising therefrom. OUPES is not responsible for all the losses caused by the user's failure to use the product in accordance with the User Manual.

In compliance with laws and regulations, OUPES reserves the right of final interpretation of this document and all related documents of this product. Subject to update, revision or termination without prior notice, please visit official website for the latest product information.

- The Company is not responsible for any damage caused by force majeure (e.g. fire, typhoon, flood, earthquake or customer's negligence, abuse or use in other unusual circumstances).

- The Company is not responsible for the loss caused by the use of non-standard connectors.

- The Company is not responsible for any damages caused by the wrong operation which don't follow the instructions of user manual.

OUPES APP

Control, monitor and customize your OUPES Mega3 from afar with the OUPES App.
Download at: <https://wp-cn.doiting.com/release/oupes/download.html?param=1,JTEK3,0>

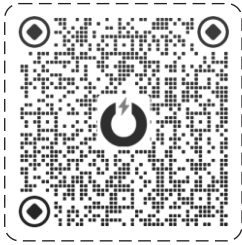

Privacy policy

By using OUPES Products, Applications and Services, you consent to the OUPES Term of Use and Privacy Policy, which you can access via the "About" section of the "User" page on the OUPES App or on the official OUPES website at

<https://oupes.com/pages/terms-and-conditions>
and
<https://oupes.com/pages/privacy-policy>

Sign up and log in

Sign up

Open the App, click "**Sign up now**" to sign up.

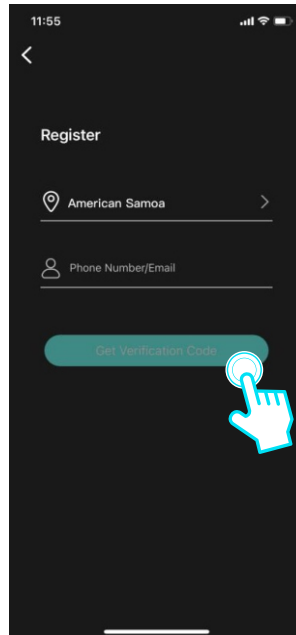
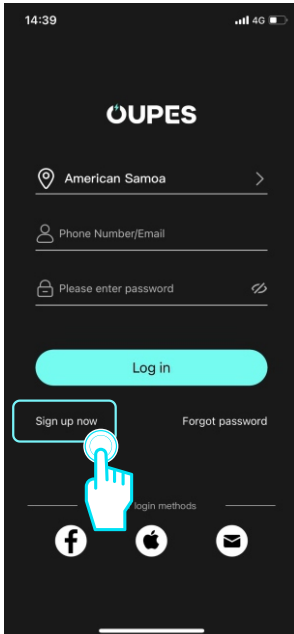

Log in

If you have an account already, tap "Log in" to enter your account name & password. If you forget your password, on the password login page, click "Forgot Password" and follow the steps to reset it.

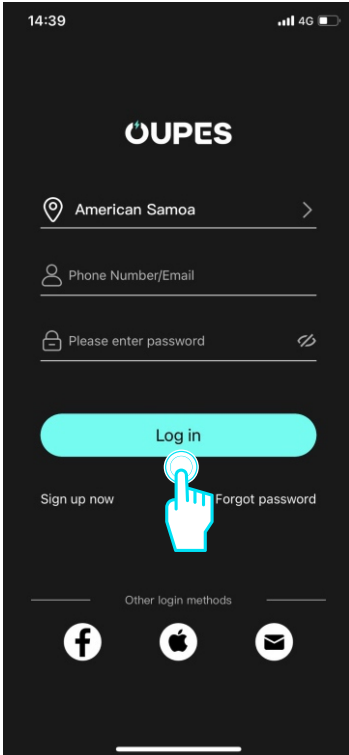

Log in by third-party account

The Android version OUPES App supports users to log in through Facebook and Google accounts. The IOS version OUPES app supports users to log in through Facebook, Google, and Apple ID. Click the third-party platform icon at the bottom of the OUPES App login interface to log in using a third-party account.

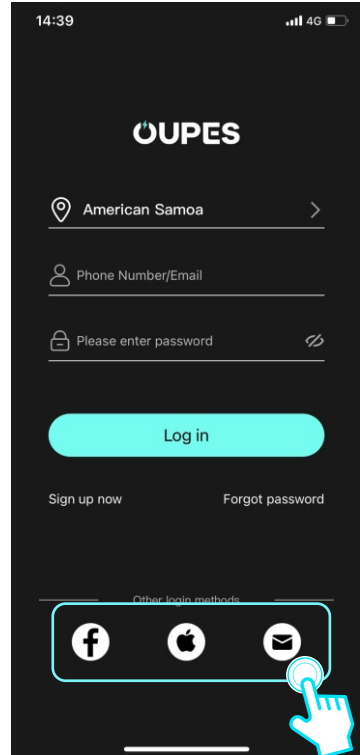

Connection setup

There are three connection methods for OUPES devices: Bluetooth, the device's Wi-Fi hotspot, and IoT.

When the OUPES App establishes a Bluetooth or a Wi-Fi hotspot connection with the device, you can view the real-time status of the device through the App, then control and manage the device wirelessly. OUPES also provides users with an advanced way to connect devices: IoT connection. Based on establishing a Bluetooth or Wi-Fi hotspot connection between the mobile App and the

device, the device can be set up to connect to the Internet by joining your Wi-Fi, and the connection has changed to the IoT connection at the same time, then users can use the App to control and manage the OUPES device anytime and anywhere.

Bluetooth connection

Automatically discover Bluetooth devices

Turn on the "IoT" button on the device, the APP will automatically search and pop up "Discover Device", click to confirm to add the device.

Select the device to be link and click Next.

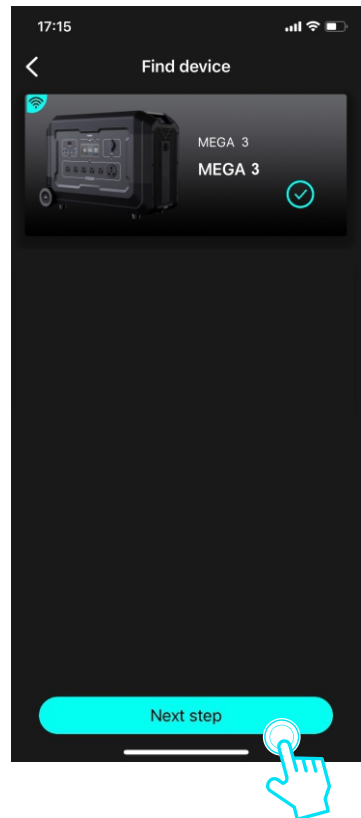
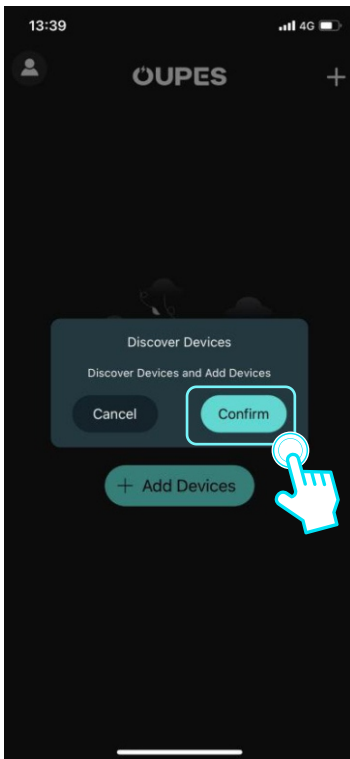

Click the pairing button and match the 2.4GHz frequency Wi-Fi signal, enter the password and click OK. After the Wi-Fi matching is successful, start to connect the device. After the loading is completed, the connection is successful.

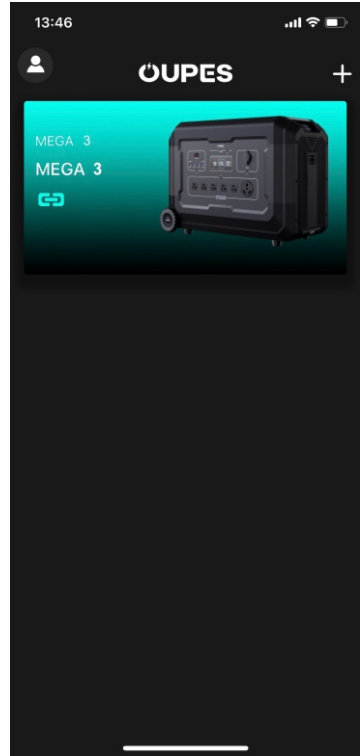
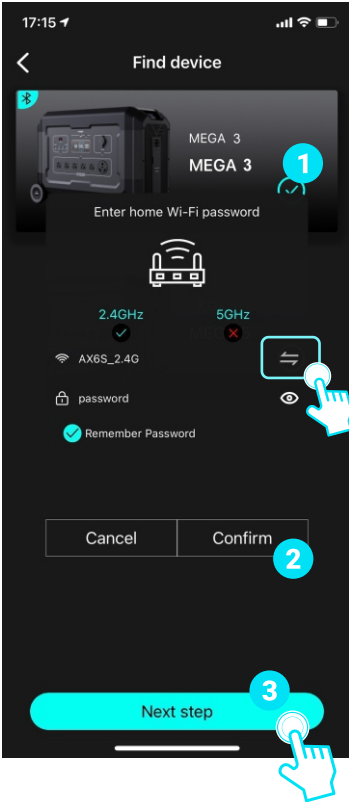

Note: Mega3 only supports 2.4GHz frequency Wi-Fi connection, please use 2.4GHz frequency Wi-Fi.

Automatically discover Bluetooth

If the "Discover devices" dialog does not appear on the home page of the App, you can click the "Add Device" button to search for nearby Bluetooth devices. If you click the "Add Device" button, the App does not scan the Bluetooth of the device to be added, you can manually select the corresponding device, and reset it according to the App guidelines, then connect the Bluetooth. If the Bluetooth cannot be found after the above steps, please check whether the device is powered on and try again. If you fail repeatedly, please contact the official customer service for technical support.

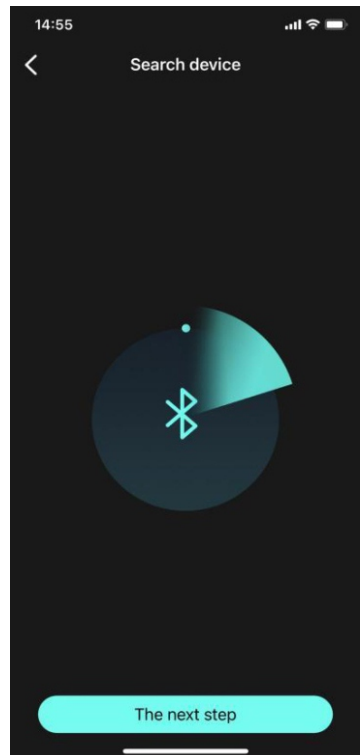
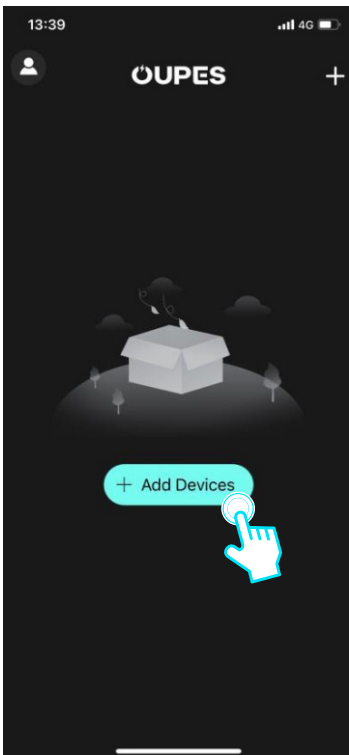

Device's Wi-Fi hotspot connection

Click the "Add Device" button on the home page of the App, you can select the corresponding device that supports a Wi-Fi hotspot connection in the manually added device list, and according to the instructions of the App, click the "IoT" button to reset the device and connect to Wi-Fi hot spot.

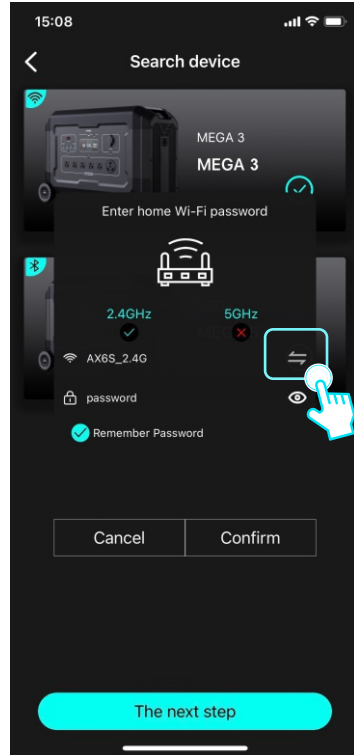
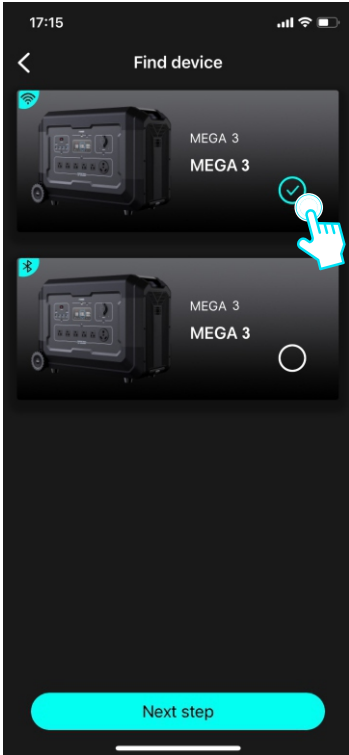

IoT connection

Before establishing a Bluetooth or a Wi-Fi hotspot connection between the App and the device, please ensure that the device is installed with OUPES App and connected to the internet. At this time, the device is connected to the IoT, and the Mega3 can be controlled by App anywhere with the Internet.

Device Control and Upgrade

Device Control

After the successful connection, the App will display the connected device. By clicking the corresponding device icon, you can enter the device details page to view the real-time status and data, and control it.

Device Control

When the App is connected to the device via Bluetooth, Wi-Fi hotspot, or IoT, it is online. You can view the device status and data in real-time on the App device details page, control the device, unbind the device, etc.

Device is Offline

When there is no Bluetooth, Wi-Fi hotspot, or IOT connection between the App and the device, is offline, and you cannot view the device status and data or control the device in the App.

Firmware upgrade

The firmware upgrade function is an essential feature of the OUPES App. A new firmware version will be released to fix known bugs, improve performance, and add new features.

Check for new firmware version

There are two methods to check whether the current device has a firmware version to be upgraded: automatic detection and manual checking.

Automatic detection: After the App enters the device details page, if an upgradeable firmware version is detected, a pop-up window will appear to remind you to upgrade it.

Manual checking: You can upgrade the firmware by selecting the "Firmware Upgrade" item from the Settings of App device details page.

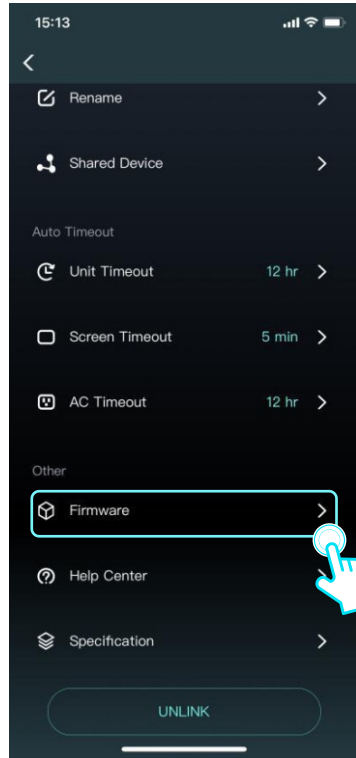

Personal Settings and More

Modify avatar and nickname

Enter the OUPES App, click the "👤" button at the upper left to enter the homepage, and then click the avatar and nickname area at the top to enter the Personal Settings page.

On the Personal Settings page, click the avatar or nickname button, and follow the prompts on the page to modify the avatar or nickname.

Change Password

On the Personal Settings page, click the "Set Password" button, enter the previous and the new password twice according to the page prompts, and click Finish.

Product List

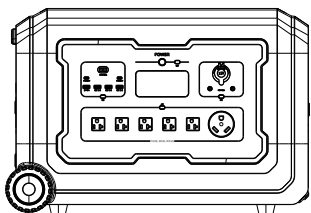

OUPES Mega 3

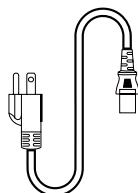

AC Charging Cable

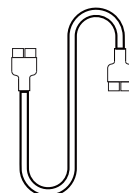

Anderson Cable

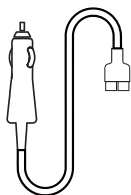

Anderson-Car
Charging Cable

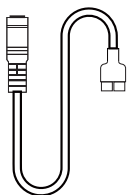

Anderson-7909 Cable

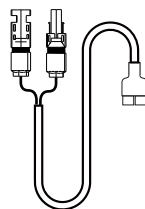

Anderson-MC4 Cable

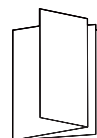

User Manual &
Warranty Card

Product Description

Parameter Specifications

Output Technical Parameters		
AC Output	Rated Voltage	100~120Vac
	Rated Power	3600W
	Peak Power	7000W
	Frequency	60Hz
DC 12V & Car lighter Output	Rated Voltage	12V
	Rated Current	10A
USB-A Output	5V/3A; 9V/2A; 12V/1.5A 【18W Max】 ; 5V/2A (Some iPhones are not applicable.)	
USB-C Output	5V/3A; 9V/3A; 12V/3A; 15V/3A; 20V/5A 【100W Max】	
Anderson Output	12V/30A	
Input		
AC Charge Input	100~120Va.c 16A Max 1800W Max	
PV(Anderson) Input	12~150Vd.c 15A Max 2100W Max	
Battery		
Rated Capacity	3072Wh	
Rated Voltage	51.2 V	
Battery Type	LiFePO ₄	

Common Information

IP Grade	Ip21
Working Temperature	0~40°C
Dimensions	25.2*11.9*17.2in (641.5*304.5*437.5mm)
Net Weight	83.33lb(37.8kg)

Function Description

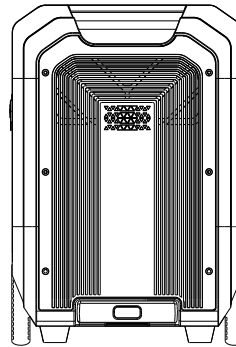
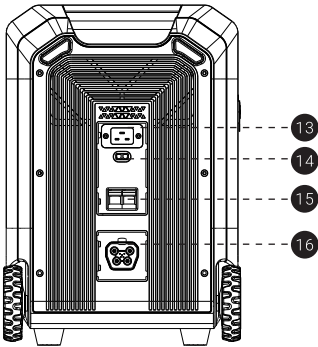
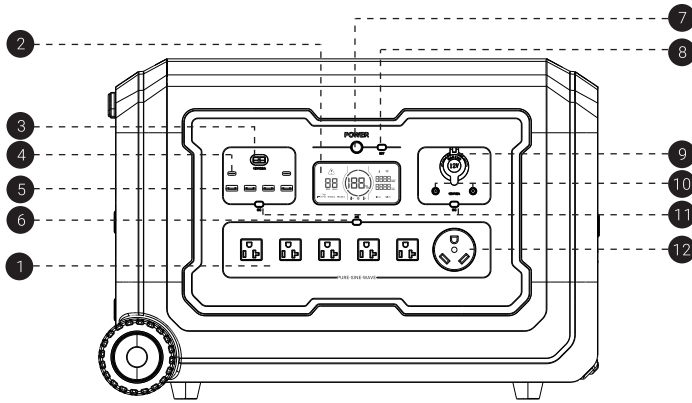

1. AC Output Port (20A Max)

2. LCD Screen

3. Anderson Output Port

4. USB-C Output Port

5. USB-A Output

6. AC Output Power On/Off Switch

7. Main Power On/Off Switch

8. IOT On/Off Switch

9. 12V Car Charger Output Port

10. DC 5521 Output Port

11. DC Output Power On/Off Switch

12. AC Output Port (30A Max)

13. AC Recharging Input Port

14. Anderson Input Port

15. Circuit Breaker Protection Switch

16. Fuel Pack Connection Port

LCD Screen Description

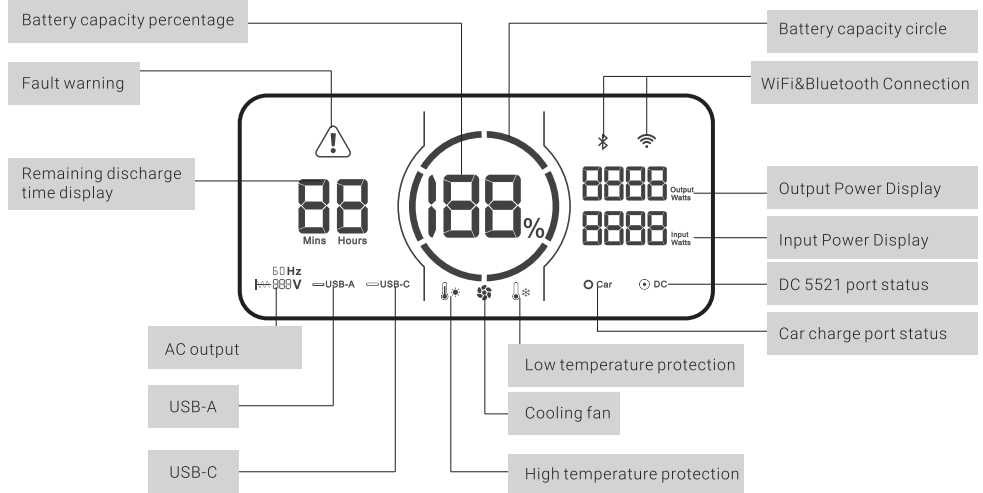

Instructions for use

The LCD Battery Capacity Circle indicates the remaining capacity. The circle has been divided into 6 equal segments, accounting for about 17%~35%~51%~68%~85%~100%.

When discharging, the blue segments of the circle will disappear to the real-time remaining capacity. When recharging, the blue circle will be flashed clockwise along the trajectory, and the digital number on the right of the circle will show you the real-time input charging power. After full charge, the whole blue circle will light up and remain stable. When charging is complete, please unplug the adapter.

Long press the power button, the power station is turned on, the LCD screen lights up, and the power button enters the white light breathing status; long press the power button (about 3 seconds or more), the product shuts down, and the LCD screen goes out.

When the main power button is turned on, lightly press the separate button of each part, the corresponding LCD screen will light up the function icon at the same time, and the function of the corresponding part can be used normally; lightly press the separate button again, the corresponding LCD screen icon will go out, and the function of the corresponding part will stop working.

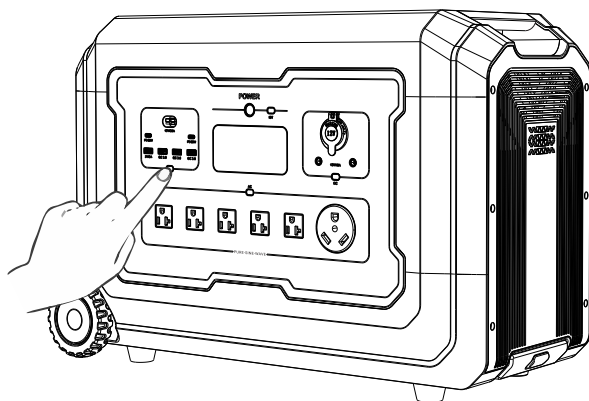

Notice :

1. After the product is turned on, short press the main power button, the LCD screen will turn off but the product will not be turned off.
2. If the product is not operated within 5 minutes, the product will enter the

sleep state and the LCD screen will automatically turn off. When the product has a load change or operation, the LCD screen automatically lights up.

3. The default standby time of this product is 12 hours. (Only main power on). The product will automatically shut down after 12 hours, and the standby time can be set on the APP.

Recharge Methods

AC Charging

Use the standard AC charging cable to charge the device and connect it as shown in the figure. When a reading appears on the input power on the screen, the device starts to charge. It can support fast charging up to 1800W, and the device can be fully charged in about 1.7 hours.

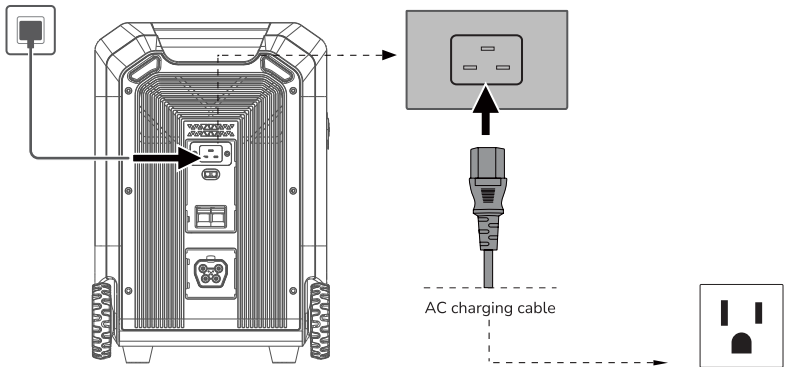

Note: Please use the AC Charging Cable included in the package for fast charging. Do not use other cables to charge. Plug directly into an AC wall outlet and make sure that the wall output current is more than 16A. Otherwise, reduce the unit charging speed with the AC Charge Speed Switch. OUPES takes no responsibilities for any consequences caused by failures to follow instructions, including but not limited to charging with other AC charging cables.

Instruction for Fast Charging & Slow Charging Switching Function

Note: The product must be turned on, and the input and output ports must be cut off.

1. Simultaneously press the IOT button + the left DC button for 3~5 seconds, the LCD screen flash and display 'SET', the product enter the input power switching interface, lightly press the IOT button to switch, 'L' means slow charging (900W input) , 'H' means fast charge (1800W input);
2. After the switching is completed, press the POWER button for 3~5 seconds to confirm the setting: the LCD screen stop flashing and display 'SUC', which means the setting is successful;
3. Press the POWER button again for 3~5 seconds to exit the fast charging & slow charging switching function.

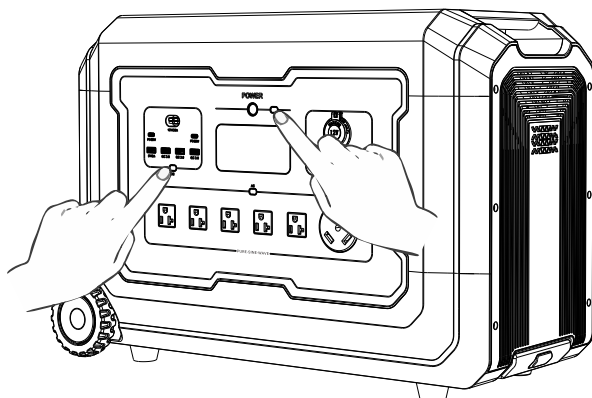

Solar Charging

Use the accessories 1 pcs Anderson-MC4 cable and 6 pcs MC4-7909 cables to connect the standard solar panel(up to 6 standard solar panels) with the device, and it will be fully charged in about 2.5H.

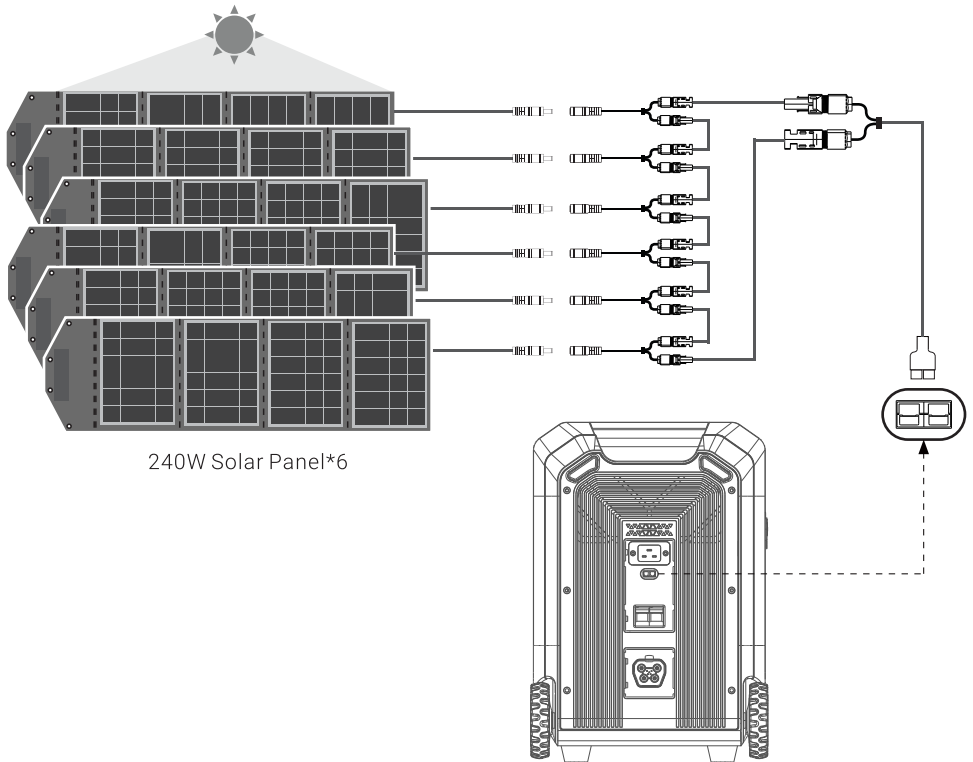

Notice :

1. The solar charging cable (MC4-7909 cable) and solar panel need to be purchased extra by yourself.
2. When using the matching solar panel to charge this product, please connect it according to the user manual.

Notice :

3. Before connecting the solar panel, please confirm that the output open circuit voltage of the solar panel is within 150V to avoid damage to the product.

Car Charging

Use the car charger port of the car to charge this product, supporting 12V/8A car charger charging. For protecting the car battery from losing power and unable to start, it is necessary to use the car charger to charge after the car is started. At the same time, ensure that the car charger port and the cigarette lighter of the car charger input cable are in good connection. The company shall not be held responsible for any loss caused by non-compliance with the standard operation.

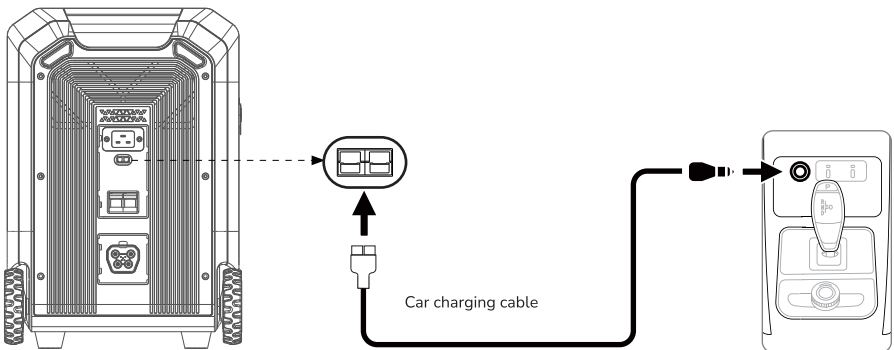

Power Pack Charging

Connect the power station and the battery pack with the dedicated cable. When the LCD display shows the charging power, it starts to charge. The battery pack can be also charged by solar charging or car charging port alone. The battery pack is sold separately.

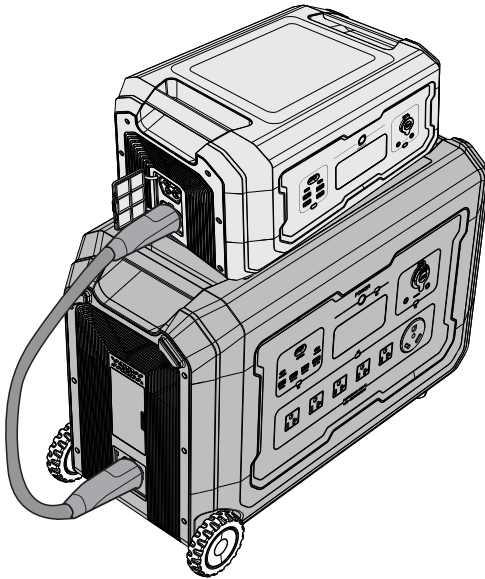

Notice :

1. Please make sure that both the product and the power pack are turned off Before connecting the power pack to this product,.
2. After this product is connected to the power pack, make sure that the LCD display of this product shows the input power, and then start to use.
3. Do not directly connect or remove the power pack during the charging and

discharging process. If you need to connect or remove the power pack when using, please turn off the power before operating.

4. Do not use your hands or other objects to touch the metal terminals at the connection port of the power pack . If there are foreign objects attached to the metal terminals, please lightly wipe with a dry cloth.

Other Functions

EPS(Emergency Power Supply)

This product supports EPS (emergency power backup) function. When connecting the power grid and the AC input port of this product through the AC charging cable, the electrical appliance can connect the AC output port of this product to work (the AC power comes from the power grid instead of the battery at this time). When the power grid is suddenly cut off, the product can be automatically switched to the battery power supply mode within 20ms.

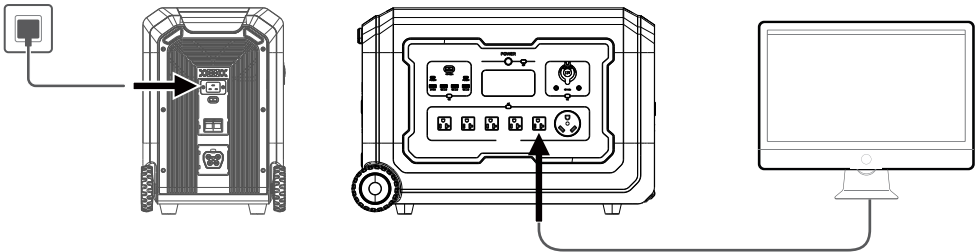

Notice :

This function is a non-professional UPS function and does not support 0ms switching. Please do not connect it to devices that require high uninterrupted power supply (such as data servers and workstations), or use it after multiple tests to confirm whether it is compatible. And it is recommended to use only one device during use, and the operating power of the device should not exceed 2200W (input + output). When the load and charging reach 2200W, the output will be turned off in one minute for overloading, and the output will be turned off in 1 second for more than 2200W. Do not use multiple devices at the same time to avoid overload protection of this product. If the device does not operate normally or data is lost due to failure to follow the instructions, the company will not bear the corresponding responsibility.

Frequency Switching

1. In the power-on state, turn off the AC output, and press the main power button & the DC button(USB output) at the same time to enter the switching frequency menu.
2. Press the AC output button to switch the frequency, the frequency to be set will continue to flash.
3. Long press the main power button to set the frequency, SUC will be displayed if the setting is successful, and then long press the main power button to exit the setting menu.

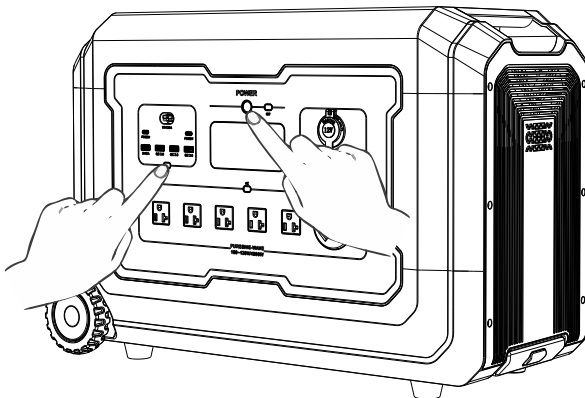

Disconnection switch

The main function of the circuit breaker is to cut off and connect the load circuit, and cut off the fault circuit to prevent the expansion of the accident and ensure safe operation. In the case of electrical overload or abnormal operation, if a fault occurs, the circuit breaker will automatically disconnect the switch to protect electrical appliances and circuits.

1. Please turn on the AC IN switch when charging by mains electricity.
2. Please turn on the AC OUT switch when loading with AC output, otherwise there will be no output at the AC output port;
3. Please turn on the AC IN and AC OUT switches at the same time if you want to use EPS function (Load takes precedence over charging: charging+load < 2200W).

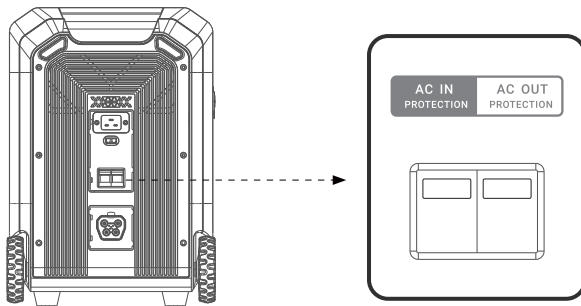

FAQ

1. What battery does the product use?

It uses high-quality lithium iron phosphate batteries(LiFePO₄).

2. What devices can the product's AC output port power?

With 3600W rated power and 7000W peak power, the product's AC output port can power most household appliances. Before you use it, we recommend that you confirm the power of the appliances first and ensure the power sum of all loaded appliances is lower than the rated power.

3. How long can the product charge my devices?

The charging time is shown on the product's LCD Screen, which can be used to estimate the charging time of most appliances with stable power usage.

4. How can I know if the product is charging?

When it's charging, the remaining charging time will be shown on the LCD Screen. Meanwhile, the charging indicator icon begins to rotate with the remaining battery percentage and the input power shown on the right of the circle.

5. How to clean the product?

Please gently wipe it with a dry, soft, clean cloth or paper towel.

6. How to store the product?

Before storing, please turn off the product first, and then store it in a dry, ventilated place at room temperature. Do not place it near water sources. For long-term storage, please discharge and charge it every three months to extend its battery life.





















7. Can this product be taken on the plane?









No.

8. Is the actual output capacity of the product consistent with the capacity stated in the user manual?

The capacity indicated in the user manual is the rated capacity of the battery pack of this product. Since this product has a certain efficiency loss during the charging and discharging process, the actual output capacity of the product is lower than the capacity specified in the user manual.

Fault Code and Trouble Shooting

Code	Description	Performance	Trouble Shooting
E000	AC output short circuit protection	  flashing, no output	Press the AC Output Power on/off button for recovery
E001	Output overload protection	  flashing, no output 	Flashing icons indicates which circuit overload. Overload protection needs to be restored manually, UPS function overload 2200W1min, 3600W1sec
E002	AC battery low power protection	The corresponding port has no output	Restart the corresponding function button to restore the function and charge in time
E003	AC output over-voltage and low voltage protection	 flashing, no output	Press the AC Output Power on/off button for recovery
E004	Abnormal AC input frequency	 flashing, no output	The frequency is normal and automatically restored
E005	Busbar high and low voltage, over-current	 flashing, No output from each part	Need to manually press the AC ON/OFF switch to restore
E006	<ul style="list-style-type: none"> ● Inverter over-temperature charging ● over-temperature protection 	  flashing, no output 	Automatic recovery after the temperature returns to normal.
E007	PV input over-voltage and low voltage protection	No PV charging	Return to normal charging after the photovoltaic input voltage is normal.
E008	12V30A overload short circuit protection	  flashing, no output	Need to manually press the DC ON/OFF switch to restore
E009	24V auxiliary power overload short circuit alarm	The DC board reports a fault, but does not turn off the output.	Reduce the load on DC port
E010	Cigarette lighter port overload and short circuit	  flashing, no output	Need to manually press the DC ON/OFF switch to restore
E011	USB-A port overload and short circuit	  flashing, no output	Need to manually press the DC ON/OFF switch to restore
E012	USB-C port overload and short circuit	  flashing, no output	Need to manually press the DC ON/OFF switch to restore
E013	Battery low voltage protection when DC discharge	 flashing, no output	Restart the corresponding function button to restore the function and charge in time

Code	Description	Performance	Trouble Shooting
E020	BMS Communication fault	 flashing, no output	Check the BMS communication line
E021	Single cell of the battery over-voltage	Capacity percentage flashing	Put the device aside and wait for the cell voltage to recover automatically.
E022	Single cell of the battery low-voltage	Capacity percentage flashing	Connect the AC charging cable and charge until the voltage returns to normal.
E023	The total voltage of the battery is too high	E023 codeflashing, but does not turn off the output	Put the device aside and wait for the cell voltage to recover automatically.
E024	The total voltage of the battery is too low	 flashing, no output	Connect the AC charging cable and charge until the voltage returns to normal.
E025	Battery cell over-temperature	  flashing, no output	Temperature recovery automatic recovery
E026	Battery cell low-temperature	  flashing, no output	Temperature recovery automatic recovery
E027	System overload	The AC icon flashes to turn off the AC function, and the DC output is normal AC load is higher than 3600W or AC+DC loads are higher than 3600W	Need to manually press the AC ON/OFF switch to restore
E028	Charging over-temperature	  flashing, device stops input	Temperature recovery automatic recovery

Storage & Maintenance

1. Please store the product away from water, heat, and metal objects.
2. In order to prolong the service life of the battery, it is recommended to use or store this product in an environment temperature between 20°C to 30°C .
3. For long-term storage, please charge and discharge the product once every 3 months (discharge to 0% first, then fully charge, and then discharge to 60% for long-term storage). Products that have not been charged and discharged for more than 6 months will not be covered under warranty.
4. For safety, do not store this product in an environment temperature above 45°C or below -10°C for a long time.
5. If the product has been idle for too long and the battery is severely low, it will enter a deep sleep protection mode. In such case, please charge the product before using it again.
6. For long-term storage, please place it horizontally.

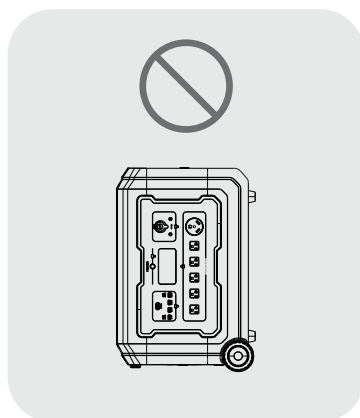
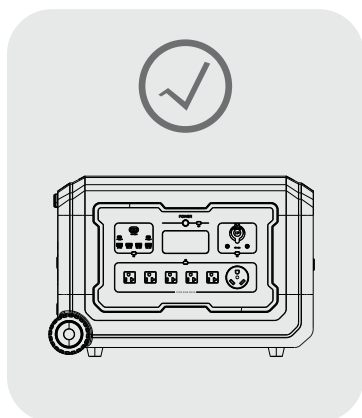

OUPEŠ