

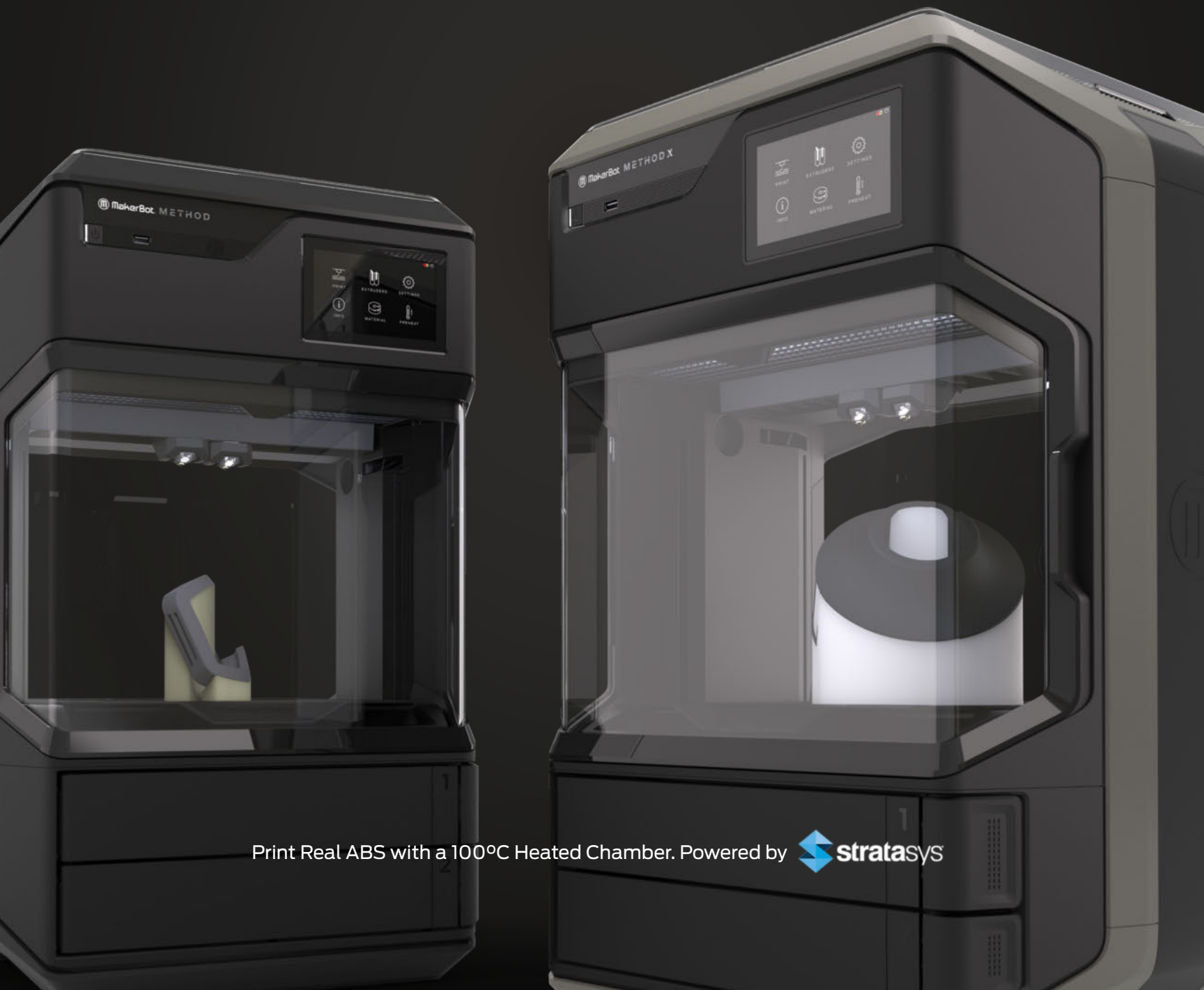

METHOD™

A Manufacturing Workstation.



Print Real ABS with a 100°C Heated Chamber. Powered by  stratasys



METHOD™

A MANUFACTURING WORKSTATION.

Print Real ABS with a 100°C Heated Chamber.

Powered by  stratasys

PRINT COMPLEX AND DURABLE ABS PARTS WITH A 100°C HEATED CHAMBER FOR END-USE ASSEMBLIES AND MANUFACTURING TOOLS.

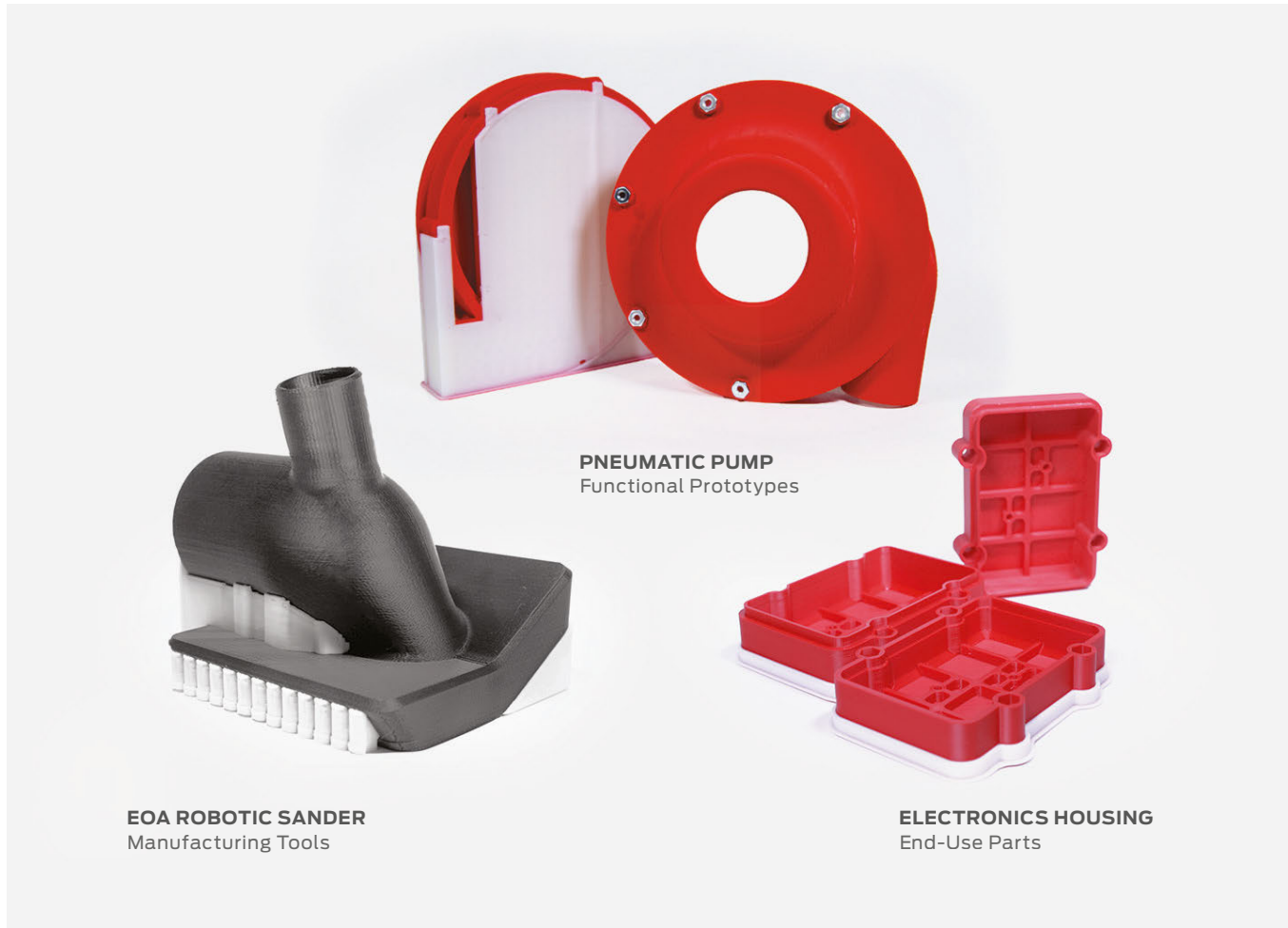

EOA ROBOTIC SANDER
Manufacturing Tools

PNEUMATIC PUMP
Functional Prototypes

ELECTRONICS HOUSING
End-Use Parts



PRINT REAL, PRODUCTION-GRADE ABS WITH A 100°C HEATED CHAMBER. POWERED BY STRATASYS®

- › Capable of withstanding 15°C higher temperatures¹ than modified desktop 3D printers ABS material formulations
- › Powered by Stratasys® SR-30 soluble support material
- › Superior Z-layer bonding provides higher strength without warping or curling

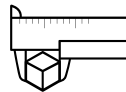

MANUFACTURING-READY MATERIALS INCLUDING REAL ABS, PETG, TOUGH, AND MORE

- › Finished part dimensional accuracy of $\pm 0.2\text{mm}$ ($\pm 0.007\text{in}$)²
- › Print complex assemblies with exact tolerances



AN AUTOMATED, TINKER-FREE INDUSTRIAL PRINTING SYSTEM.

- › 2x times faster printing than leading desktop 3D printers³
- › 300,000+ total testing hours on 150+ printers
- › Seamless CAD integration with:



MATCH DESIGN DIMENSIONS.

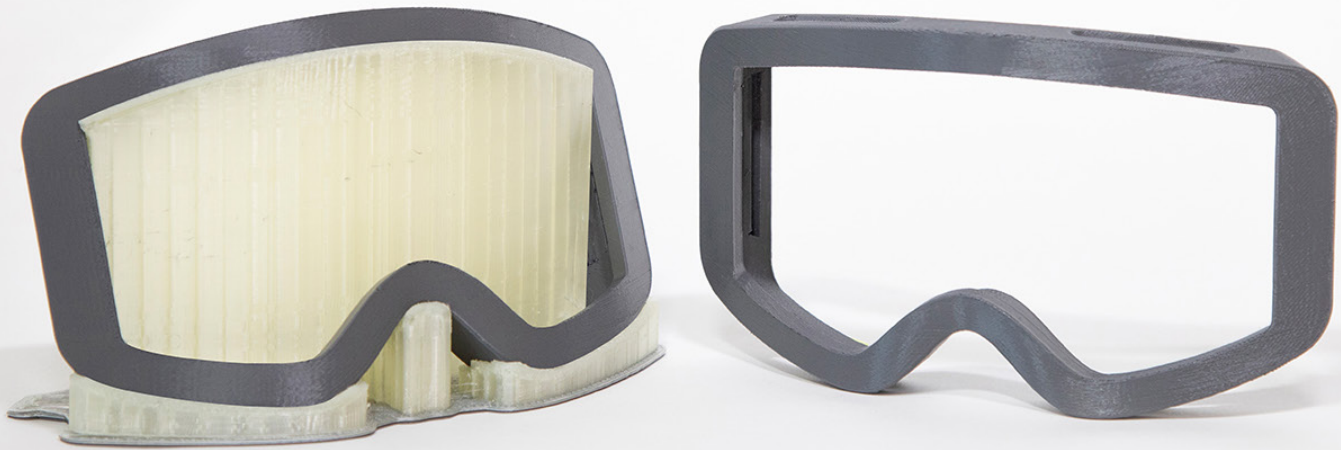

MODULAR SKI GOGGLES

ACCELERATED CONCEPT DESIGN

TECH SPECS

SIZE	17.6cm x 10.2cm x 4.9cm
VOLUME	74.5 cm ³
CAD TO PART	18h 21m
PRINTED ON	METHOD
PART COST	\$7.69 USD
MODEL MATERIAL	MakerBot Tough
SUPPORT MATERIAL	MakerBot Precision Dissolving PVA

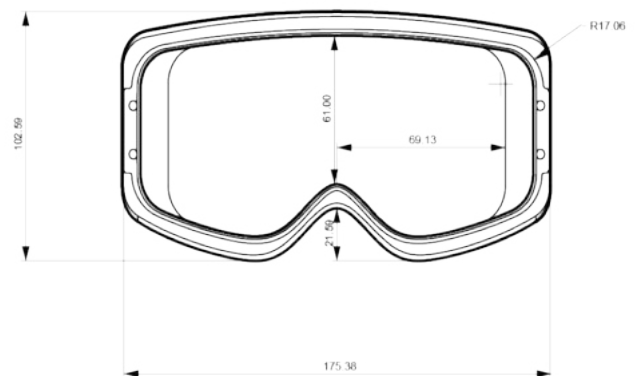

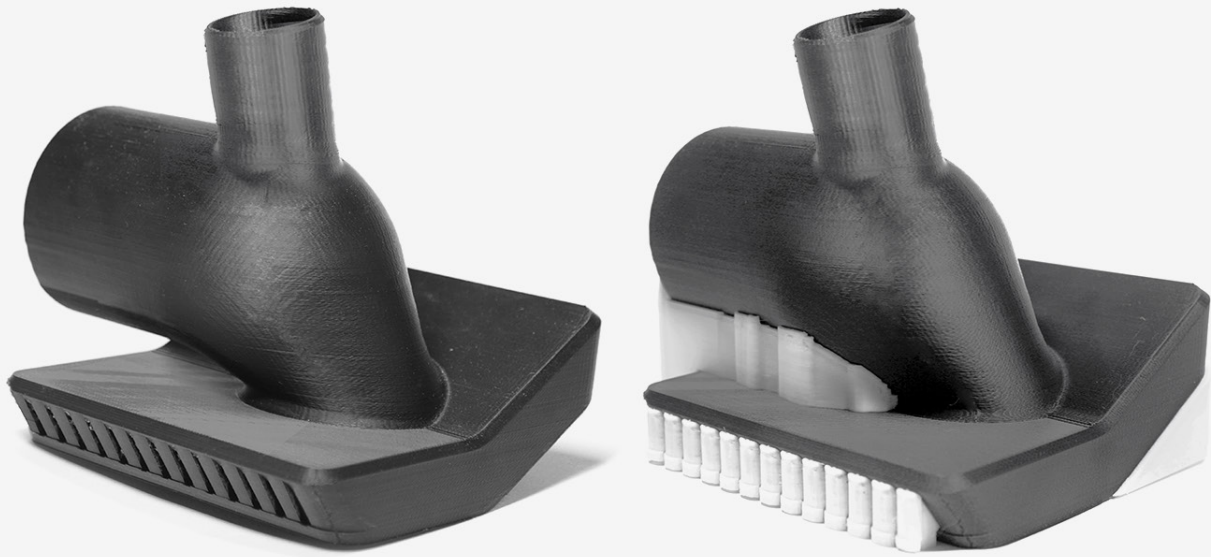

EOA ROBOTIC SANDER

MANUFACTURING TOOLS

TECH SPECS

SIZE	17cm x 15.1cm x13.7cm
VOLUME	410 cm ³
CAD TO PART	66h 15m
PRINTED ON	METHOD X
PART COST	\$12.5 USD
MODEL MATERIAL	MakerBot ABS
SUPPORT MATERIAL	Stratasys® SR-30

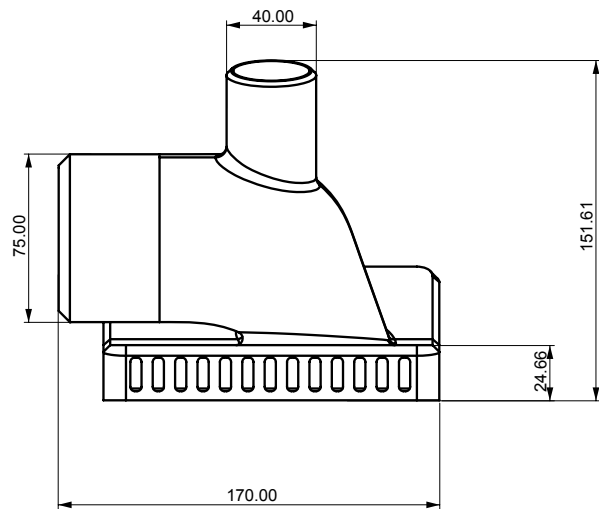

BREAKTHROUGH TECHNOLOGIES LEVERAGING PATENTS FROM STRATASYS® – THE WORLDWIDE LEADER IN INDUSTRIAL 3D PRINTING.

SENSORS + CONNECTIVITY

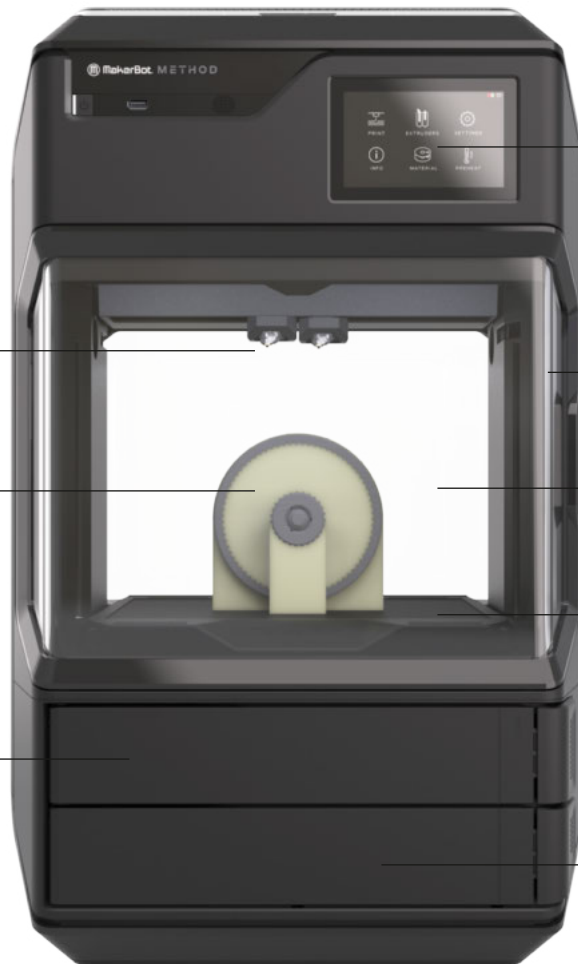

TOUCHSCREEN CONTROLS

DUAL PERFORMANCE EXTRUDERS

ULTRA-RIGID METAL FRAME
CONSTRUCTION

DISSOLUBLE SUPPORT SYSTEM

CIRCULATING HEATED CHAMBER

SPRING STEEL BUILD PLATE

DRY-SEALED MATERIAL BAYS

SMART SPOOLS AND SMART
ASSIST MATERIAL LOADER



SPEED AND DIMENSIONAL ACCURACY

DUAL PERFORMANCE EXTRUDERS

The Dual Performance Extruder system is built from the ground up to accelerate print times while providing dimensional accuracy.

SMART SENSORS FOR MATERIAL MANAGEMENT AND PRINT PROTECTION

Leveraging industrial DNA, each Performance Extruder contains a suite of sensors that detect when material is running low and allows for active jam detection during the entire print duration. It's like autonomous protection for your print—and your printer.

GREATER TORQUE WITH A 19:1 DUAL-DRIVE GEAR RATIO

From great strength comes great performance. The 19:1 dual-drive gear ratio keeps material loaded and ready for reliable material extrusion at every layer.

LENGTHENED THERMAL CORE WITH LESS THAN 60-SECOND HEAT UP TIME

A lengthened thermal core and a fast start up time ensure that materials are ready to go when your ideas are.

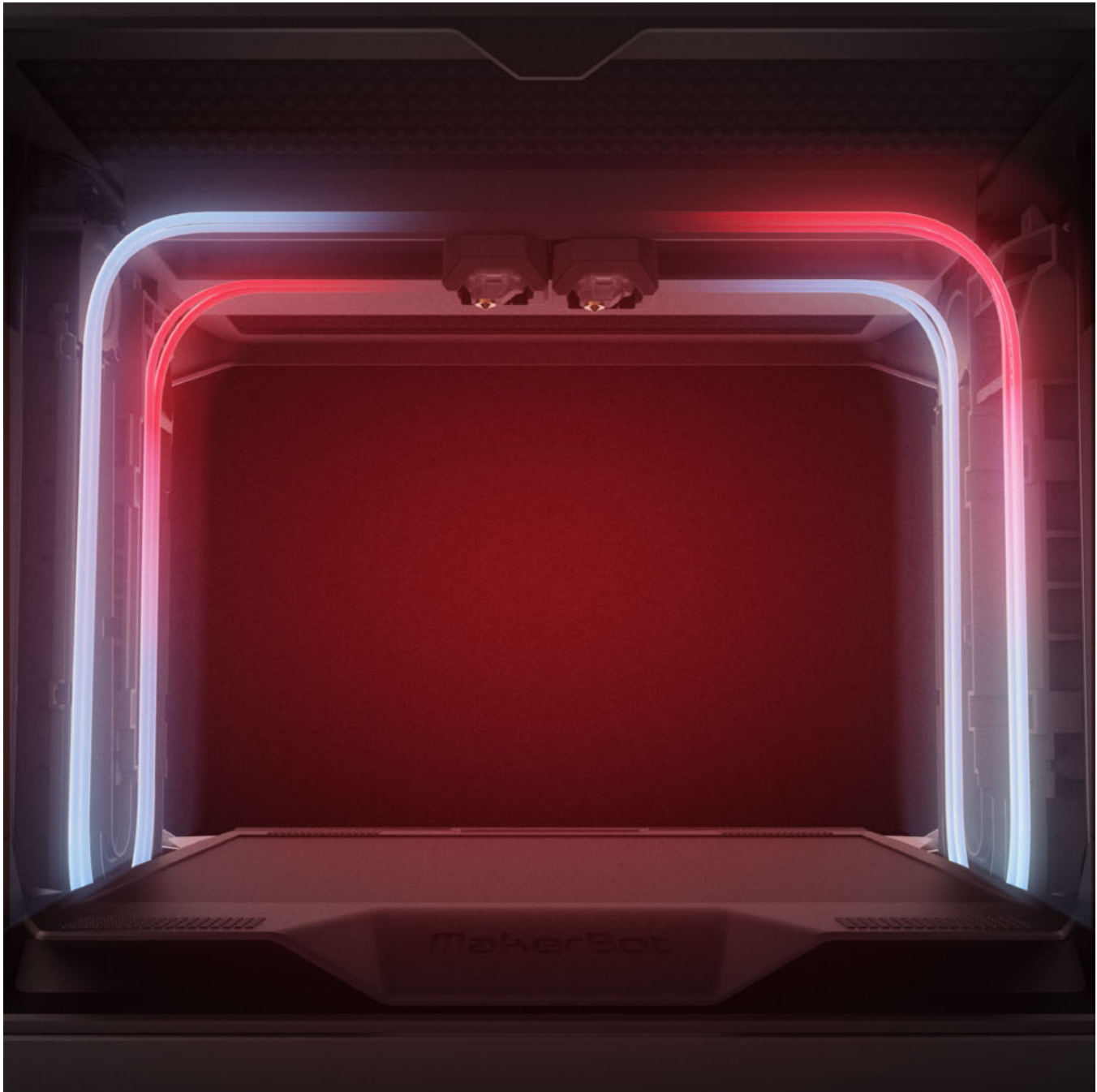

CIRCULATING HEATED CHAMBER

UNCOMPROMISED LAYER ADHESION AND PART STRENGTH

Control the temperature and quality of every layer—not just the first. While heated build plates are effective at reducing warping, METHOD takes this further with full active heat immersion during the entire duration of the print.



ULTRA-RIGID METAL FRAME CONSTRUCTION

BUILT TOUGH

A structurally-optimized metal frame runs the full length of the body to offset flexing. Less flexing means more consistent prints with better part accuracy and fewer failures.

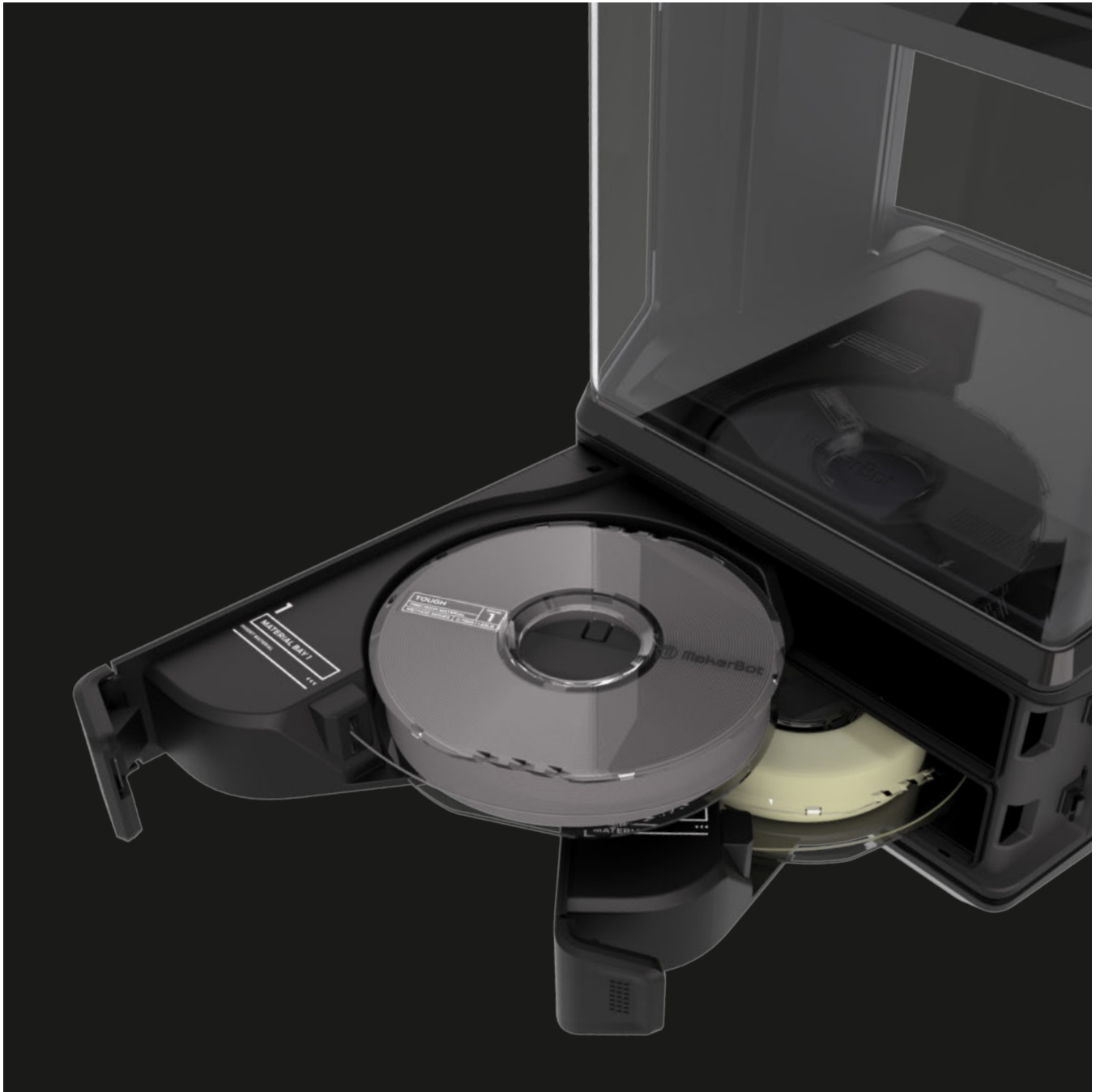

DRY-SEALED MATERIAL BAYS

OPTIMIZED MATERIAL STORAGE

Dry-Sealed Material Bays form a near-perfect seal to keep material free of damaging humidity. A suite of built-in sensors provides that your material is stored in its optimal environment—a feature previously only available in industrial 3D printers.

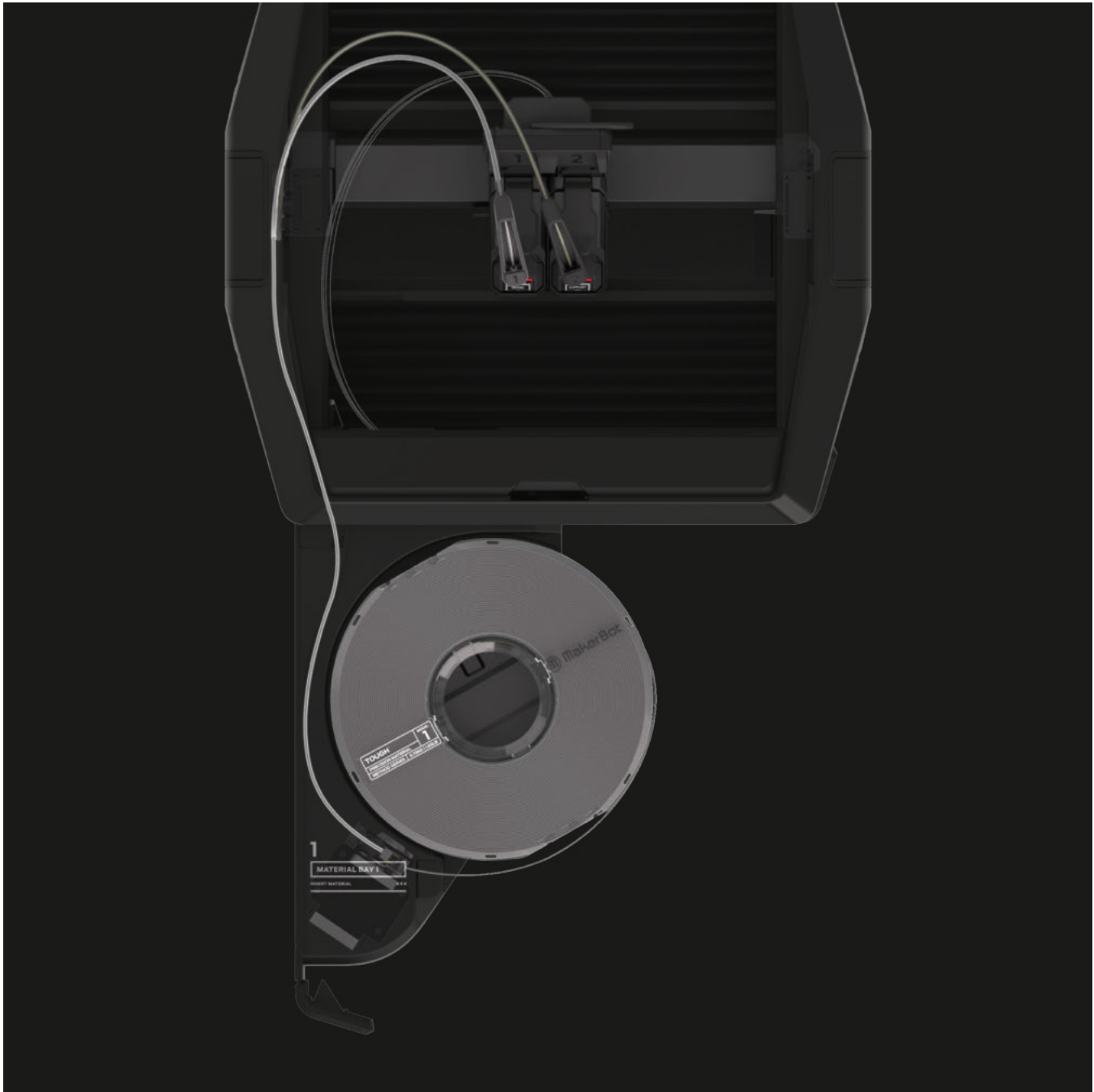

SMART SPOOLS AND THE SMART ASSIST MATERIAL LOADER

SMART MATERIAL MANAGEMENT

Insert your material and the printer does the rest. With Smart Spools, monitor material details including color and quantity remaining directly within MakerBot Print.

TOUCHSCREEN CONTROLS

Swipe, tap, print. With the built-in 5" full-color capacitive touchscreen display, receive up-to-the-second status of your current print job and navigate menus in the most intuitive way you already know—with your finger.



SMART SENSORS + CONNECTIVITY

A network of 21 intelligent sensors embedded throughout the printer gives you full control while making material and print management easy and accessible.

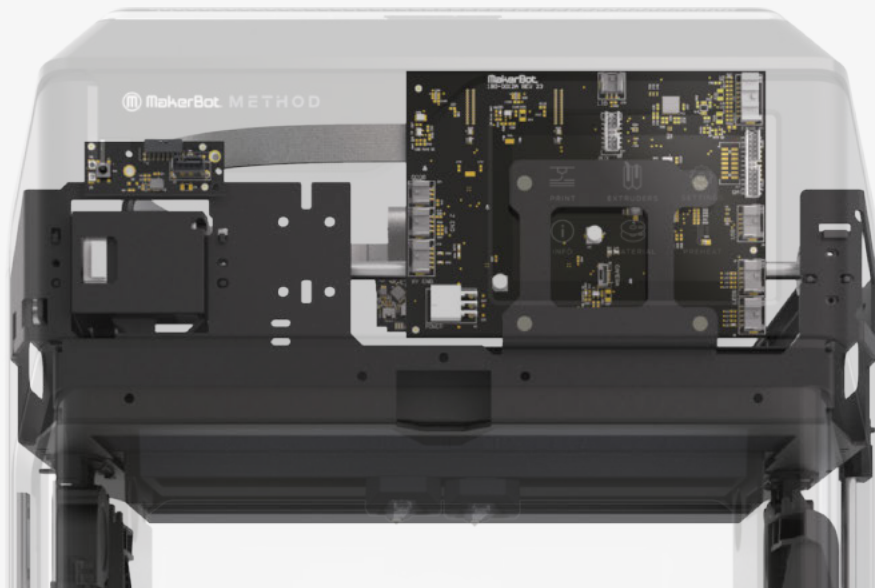

SPRING STEEL BUILD PLATE

A precision-calibrated print base and spring steel build plate provide true flatness for unyielding part accuracy.



MAKERBOT PRINT + MAKERBOT CLOUD WIRELESS PRINTING AND MONITORING

MakerBot Print works hard so you don't have to. With over 25 supported native CAD file types, you can focus on your next design sprint rather than messy plugins and conversions. Away from the office? Remotely print, monitor, and control your printer from anywhere in the world.



MAKERBOT MATERIALS FOR METHOD SERIES

MakerBot Materials for METHOD are manufactured to exacting diameter and quality specifications and shipped in a vacuum-sealed Mylar bag to preserve quality right up until opening. The new Smart Spool system sends all of your material information including color and amount remaining wirelessly to MakerBot Print for up-to-the-second material management.

Welcome to the age of smart materials.

PRECISION MATERIALS

Extensively-tested by MakerBot for the highest reliability and measurably accurate parts ⁴.

SPECIALTY MATERIALS

For users looking for special materials with advanced properties to push the limits of what's possible.

MAKERBOT PRECISION ABS

MakerBot ABS for METHOD is capable of withstanding 15°C higher temperatures, is 26% more rigid, and 12% stronger than modified ABS material formulations for desktop 3D printers.

COLOR AVAILABILITY



SUPPORT MATERIAL

Stratasys® SR-30



MAKERBOT PRECISION ASA

ASA is a weather-resistant alternative to ABS that is widely used for functional prototypes and end used parts in outdoor environments.

COLOR AVAILABILITY



SUPPORT MATERIAL

Stratasys® SR-30

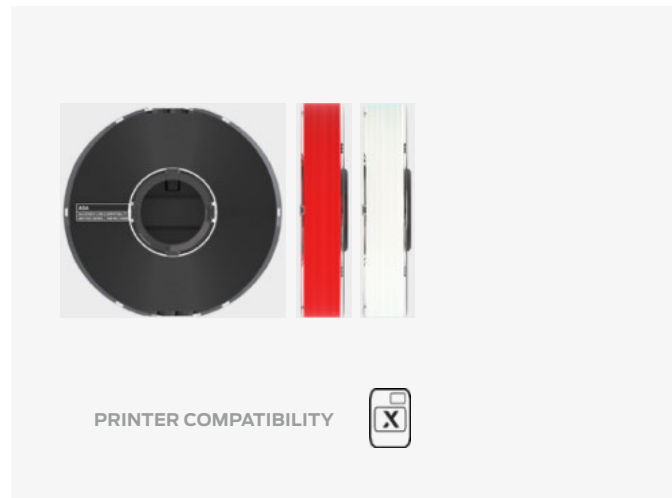

MAKERBOT PETG

High-strength and durability combine with chemical and moisture resistance to offer excellent mechanical properties.

COLOR AVAILABILITY

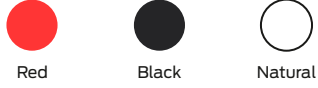

SUPPORT MATERIAL

PVA



MAKERBOT PRECISION TOUGH

MakerBot Precision Tough Material is a thermoplastic engineered for durable, strong, and precise 3D printed prototypes and fixtures.

COLOR AVAILABILITY



SUPPORT MATERIAL

PVA

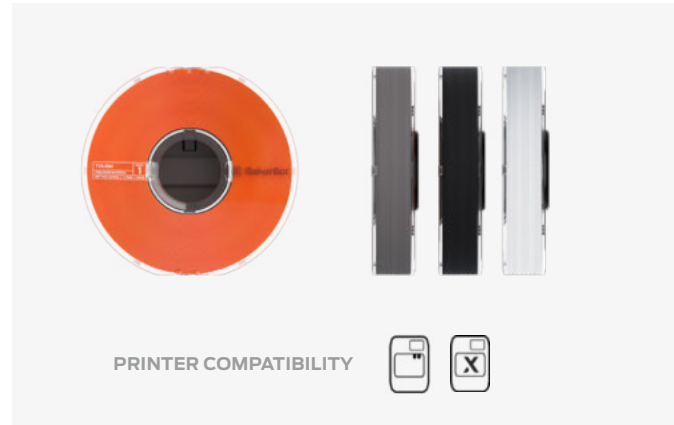

MAKERBOT PRECISION PLA

Easy to use and ideal for early-stage concept development, design details including sharp corners and edges print flawlessly with virtually no warping or curling.

COLOR AVAILABILITY

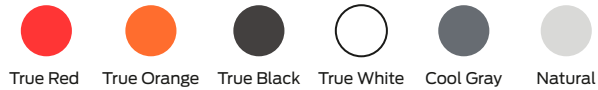

SUPPORT MATERIAL

PVA

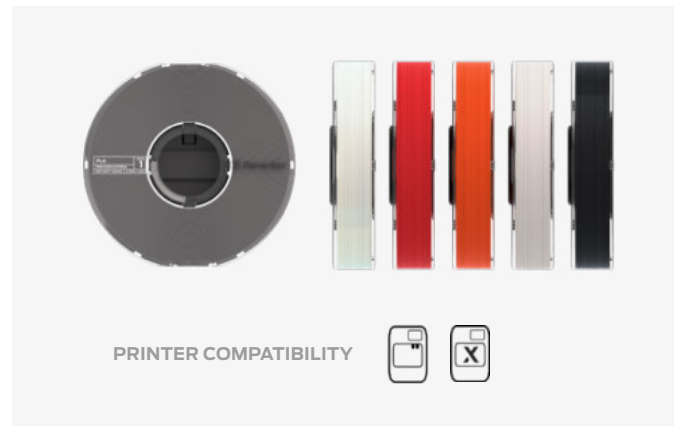

MAKERBOT NYLON

Optimized for high abrasion resistance due to excellent flexural, tensile, and impact strength. It also has good thermal properties and is heat resistant up to 180C.

COLOR AVAILABILITY



SUPPORT MATERIAL

PVA



MAXIMUM INNOVATION + MINIMAL INVESTMENT



ACCELERATE PRODUCT DEVELOPMENT

Put speed and control into your design cycles while reducing production costs to bring your products to market, fast. A project requiring 10 design iterations can be reduced to 4 days in-house using METHOD, as opposed to 40 days (including shipping) from an outsourced supplier.



REDUCED DESIGN RISK

Design mistakes found late in production can be exponentially more expensive than when found earlier in the product development cycle. METHOD allows your team to test and validate more prototypes with accuracy early and often; minimizing potential cost overruns later in production.



RECLAIM THE COST OF DEVELOPMENT TIME

Put an end to frivolous tinkering, equipment upkeep, and stalled innovation at the cost of valuable design time. With the DNA and architecture of an industrial 3D printer, METHOD is built and extensively tested by MakerBot to print reliable prototypes—no tinkering or calibration required.



EASY DEPLOYMENT AND OPERATION

Out-of-the-box deployment is fast and easy no matter the size of your organization. A range of METHOD configurations are optimized to get businesses started across multiple team sizes ranging from small design studios to factory floors.



LOW TOTAL COST OF OWNERSHIP (TCO)

From the purchase and installation to ongoing maintenance, materials, and support, METHOD is designed from the ground up to deliver industrial-quality performance at about one-third the first-year cost of ownership of an entry-level industrial 3D printer.

COMPARE METHOD MODELS



METHOD



METHOD X NEW



PRODUCT NUMBER

SKU 900-0001A

SKU 900-0002A



MATERIALS

PLA, PETG, TOUGH
NYLON NEW

PLA, PETG, TOUGH
ABS, ASA, NYLON NEW



SUPPORT

PVA

PVA
Stratasys® SR-30 NEW



CHAMBER TEMPERATURE

60°C

100°C

X bellows



Power Requirements

100 - 240 V
3.9A - 1.6A, 50 / 60 Hz
400 W max.

100 - 240 V
8.1A - 3.4A, 50 / 60 Hz
800 W max.



BUILD VOLUME

Single Extrusion
19 L x 19 W x 19.6 H cm / 7.5 x 7.5 x 7.75 in

Single Extrusion
19 L x 19 W x 19.6 H cm / 7.5 x 7.5 x 7.75 in

Dual Extrusion
15.2 L x 19 W x 19.6 H cm / 6.0 x 7.5 x 7.75 in

Dual Extrusion
15.2 L x 19 W x 19.6 H cm / 6.0 x 7.5 x 7.75 in



DIMENSIONAL ACCURACY

± 0.2mm / ±0.007in¹

± 0.2mm / ±0.007in¹



EXTRUDERS

Model Extruder
Model 1

Model Extruder
Model 1
Model 1XA

Support Extruder
Support 2

Support Extruder
Support 2
Support 2XA



APPLICATIONS



- Quick prototypes
- Fit tests
- Concept iterations

- Manufacturing tools
- End-use parts
- Functional prototypes

UNRIVALED INDUSTRY SUPPORT.

At MakerBot, we stand behind our products and know that your time is best spent innovating and printing. In addition to our Extended Warranty, MakerBot MakerCare Protection Plans provide a faster, more comprehensive level of support and service that is unrivaled in the industry. These plans include immediate phone, email, or live chat response times, quick part replacement or repair, and immediate hot swapping.

Learn more at makerbot.com/makercare.

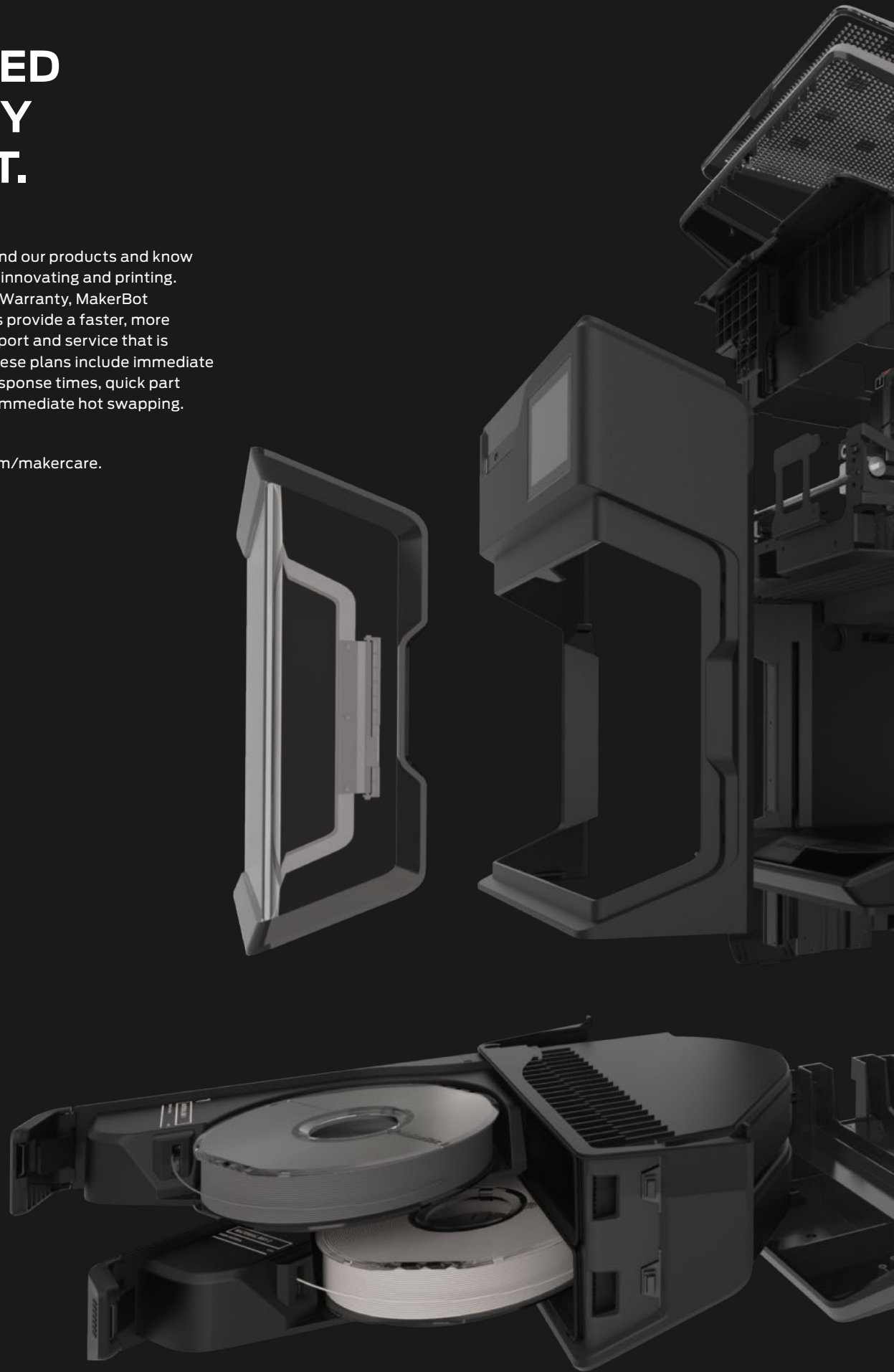

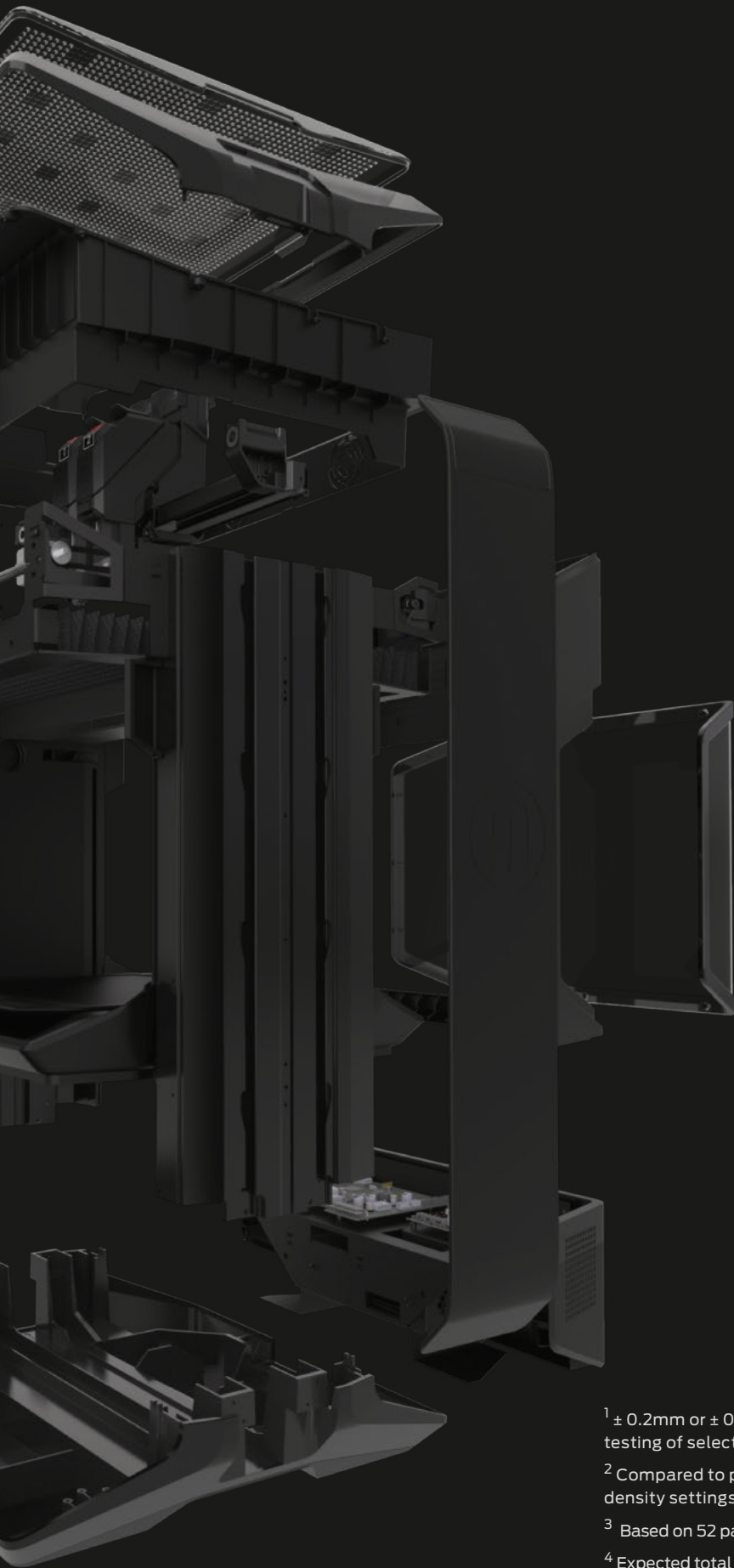

¹ $\pm 0.2\text{mm}$ or $\pm 0.002\text{ mm per mm of travel}$ – whichever is greater. Based on internal testing of selected geometries.

² Compared to popular desktop 3D printers when using the same layer height and infill density settings. Speed advantage dependent upon object geometry.

³ Based on 52 parts per year average | prices shown in USD

⁴ Expected total amount of testing to be completed prior to shipping.

⁵ Cost of material plus the cost per print of the printers depreciated over a period of 3 years.

INNOVATION. UNLOCKED.
[MAKERBOT.COM/METHOD](https://www.makerbot.com/method)