

**MAXPEEDINGRODS**  
Since 2006

# **MXR4000 GT**

DUAL FUEL INVERTER GENERATOR

## **OWNER'S MANUAL**

**MAXPEEDINGRODS**  
Since 2006



**Running  
Watts**

**3200W**  
(GASOLINE)

**3000W**  
(PROPANE)

**Peak  
Watts**

**4000W**  
(GASOLINE)

**3600W**  
(PROPANE)

# 01 INTRODUCTION

## DISCLAIMERS:

All information, illustrations and specifications in this manual are based on the latest information available at the time of publishing. The illustrations used in this manual are intended as representative reference views only. Moreover, because of our continuous product improvement policy, we may modify information, illustrations and/or specifications to explain and/or exemplify a product, service or maintenance improvement. We reserve the right to make any change at any time without notice. Some images may vary depending upon which model is shown.

## SPECIFICATIONS:

Model	MXR4000 GT	Fuel Tank Capacity	1.1gal
Running Watts	3200W(Gasoline) 3000W(Propane)	Oil Capacity	0.12gal
Peak Watts	4000W(Gasoline) 3600W(Propane)	Total Harmonic Distortion(THD)	≤3%
Rated Voltage	120V	Fuel Type	Gasoline/Propane
Rated Frequency	60Hz	Oil Type	SAE 10W-30
Phase	Single Phase	Spark Plug	A5RTC
Engine Displacement	145cc	Maximum Ambient Temperature	104°F (40°C)
Rated Speed	4850RPM	Net Weight	24kg
Starting Type	Recoil/Electric/ Bluetooth®	Generator size L*W*H(cm)	48×30.5×44



## DANGER

This manual contains important instructions for operating this inverter generator. For your safety and the safety of others, be sure to read this manual thoroughly before operating the generator. Failure to properly follow all instructions and precautions can cause you and others to be seriously hurt or killed.

# 02 WARRANTY

## 1 DURATION:

Maxpeedingrods warrants all the inverter generators against defects in workmanship under normal use for a period of 2 years from the date of retail purchase by the original end-user purchaser ("Warranty Period"), and free lifetime technical support and customer service. If a product is used for business, commercial, or industrial applications, the warranty period will be limited to ninety (90) days.

## 2 WHO GIVES THIS WARRANTY (WARRANTOR):

Chongqing Guoyu Technology Co., Ltd

## 3 WHO RECEIVES THIS WARRANTY (PURCHASER):

The original purchaser (other than for purposes of resale) of the MAXPEEDINGRODS inverter.

## 4 WHAT PRODUCTS ARE COVERED BY THIS WARRANTY:

Any portable generator supplied or manufactured by Warrantor.

## 5 WHAT IS COVERED UNDER THIS WARRANTY:

Substantial defects on material and workmanship which occur within the duration of the warranty period.

## 6 WHAT IS NOT COVERED UNDER THIS WARRANTY:

**A.** Transportation changes for sending the product to Warrantor or its authorized service representative for warranty service, or for shipping repaired or replacement products back to the customer; these charges must be borne by the customer.

**B.** Damages caused by abuse, accident, shipping, misuse, overloading, modification, and the effects of corrosion, erosion and normal wear and tear.

**C.** Warranty is voided if the customer fails to install, maintain and operate the product in accordance with the instructions and recommendations set forth in the owner's manual(s), or if the product is used as rental equipment.

**D.** Pre-delivery service, i.e. assembly, oil or lubricants, and adjustment.

**E.** Items or service that are normally required to maintain the product, i.e. lubricants and filters.

**F.** Warrantor will not pay for repairs or adjustments to the product, or for any costs or labour, performed without Warrantor's prior authorization. EXCLUSIONS AND LIMITATIONS: Warrantor makes no other warranty of any kind, express or implied. Implied warranties, including warranties of merchantability and of fitness for a particular purpose, are hereby disclaimed. This warranty service described above is the exclusive remedy under this warranty; liability for incidental and consequential damages is excluded to the extent permitted by law.

## 7 RESPONSIBILITIES OF PURCHASER UNDER THIS WARRANTY:

**A.** The purchaser must provide dated proof of purchase and must notify Warrantor within the warranty period.

**B.** Deliver or ship the serviced generator or component to the nearest Warrantor's authorized service representative. Freight costs, if any, must be borne by the purchaser.

## 8 Having any questions?

Please do contact us via your purchasing channel for quick help. We guarantee you will get satisfied and quickest solution through this way.

# TABLE OF CONTENTS

## 01

**INTRODUCTION** ----- 2

## 02

**WARRANTY** ----- 3

## 07

**OPERATION THE GENERATOR** ----- 27

## 08

**MAINTENANCE** ----- 44

## 03

**SAFETY** ----- 7

## 04

**CONTROL PANEL** ----- 14

Start the Generator ----- 28

Change Engine Oil ----- 47

Stop the Generator ----- 30

Clean the Air Filter ----- 48

Bluetooth® Function ----- 31

Replace the Spark Plug ----- 49

Pairing App ----- 31

Drain the Gasoline ----- 51

App Control Interface ----- 33

Clean the Spark Arrestor ----- 51

App Error Code ----- 35

Transport the Generator ----- 52

Low Idle Mode ----- 37

Storage the Generator ----- 53

AC Reset ----- 37

Use the Generator ----- 37

Use Generator at High Altitude ----- 38

Extension Cords ----- 39

Connect to Household Power Supply ----- 40

Connection of AC Power ----- 41

Safety Definitions ----- 8

Generator Basic Features ----- 15

Safety Symbols ----- 8

Digital Display Center ----- 16

Correct Usage ----- 9

Control Panel ----- 17

Incorrect Usage ----- 9

Carbon Monoxide Specification ----- 19

Usage Notes ----- 10

Information Notice of Bluetooth® Part ----- 19

Important Safety Instructions ----- 10

Safety Labels and Decals ----- 13

## 05

**ASSEMBLY** ----- 20

## 06

**BEFORE START THE GENERATOR** ----- 22

## 09

**TROUBLE SHOOTING** ----- 54

## 10

**SCHEMATICS** ----- 57

Unpacking ----- 21

Ground the Generator ----- 23

Package Contents ----- 21

Connect the Battery Line ----- 24

Add Engine Oil ----- 25

Add Fuel: Gasoline ----- 26

# 03 SAFETY



## SAFETY DEFINITIONS

The words DANGER, WARNING, CAUTION and NOTICE are used through out this manual to highlight important information. Be certain that the meanings of these alerts are known to all who work on or near the equipment.

### **DANGER**

Indicates a hazardous situation which, if not avoided, will result in death or serious injury.

### **WARNING**

Indicates a hazardous situation which, if not avoided, could result in death or serious injury.









### **CAUTION**

Indicates a hazardous situation which, if not avoided, could result in minor or moderate injury.

### **NOTICE**

Indicates a situation which can cause damage to the generator, personal property and/or the environment, or cause the equipment to operate improperly.

## SAFETY SYMBOLS

Symbol	Description
	Safety Alert Symbol
	Electrical Shock Hazard
	Exhaust Gas is Poisonous
	Fire Hazard
	Explosion Hazard
	Burn Hazard. (Do not touch hot surfaces)
	Read Manufacturer's Instructions
	Lifting Hazard

## CORRECT USAGE

Example location to reduce risk of carbon monoxide poisoning (see **Fig.1**).

ONLY use the generator outside and downwind, far away from windows, doors and vents.

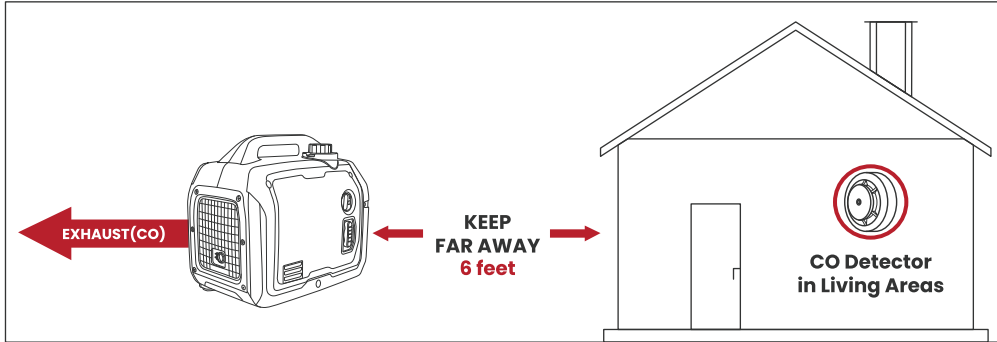
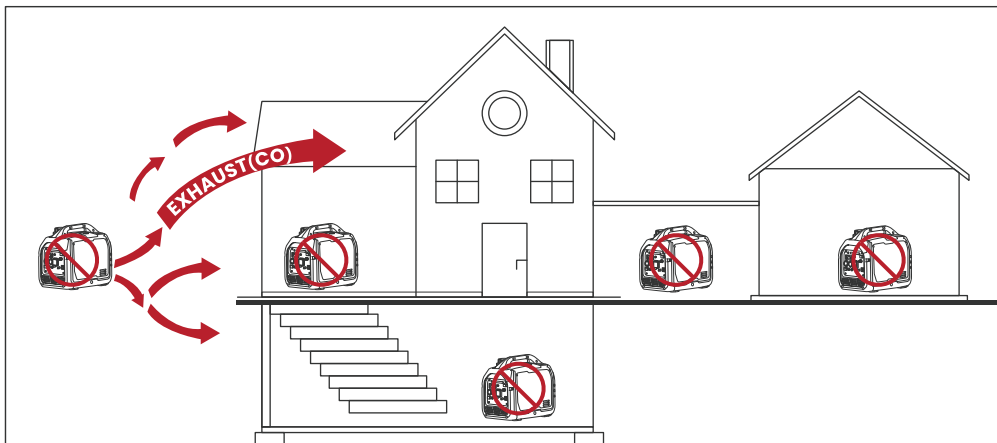

**Fig.1**

## INCORRECT USAGE

Don't use the generator in any of the following locations (see **Fig.2**):

- |                               |           |          |             |
|-------------------------------|-----------|----------|-------------|
| Near any door, window or vent | Garage    | Basement | Crawl Space |
| Living Room                   | Entry Way | Porch    | Attic       |



**Fig.2**

## USAGE NOTES



Please do not use in humid environment



Please do not smoke when refueling



Please do not spill when refueling



Please shut down the generator before refueling

## IMPORTANT SAFETY INSTRUCTIONS

### **⚠ DANGER**

Using a generator indoors CAN KILL YOU IN MINUTES. Generator exhaust contains carbon monoxide. This is a poison you cannot see or smell.



NEVER use inside a home or garage, EVEN IF doors and windows are open.



Only use OUTSIDE and far away from windows, doors, and vents.

### **⚠ DANGER**

Engine exhaust contains carbon monoxide, a poisonous gas that could kill you in minutes. You CANNOT smell it, see it, or taste it. Even if you do not smell exhaust fumes, you could still be exposed to carbon monoxide gas.

### **⚠ DANGER**

Never use the inverter in a location that is wet or damp. Never expose the inverter to rain, snow, water spray or standing water while in use. Protect the inverter from all hazardous weather conditions. Moisture or ice can cause a short circuit or other malfunction in the electrical circuit.



**DANGER**

Powerful voltage produced by the inverter could result in death or serious injury.

- DO NOT touch bare wires or receptacles.
- DO NOT operate generator in wet weather.
- DO NOT use worn or damaged electrical cords.
- DO NOT touch an operating inverter if the inverter is wet or if you have wet hands.
- DO NOT allow children or unqualified persons to operate or service the generator.
- Be sure the inverter is properly grounded before operating.
- When using generator for backup power, notify utility company.



**DANGER**

Gasoline and its vapors are extremely flammable and explosive under certain conditions, could cause burns, fire, or explosion resulting in death or serious injury and/or property damage.

- Fill or drain fuel tank outdoors, in a well-ventilated area.
- DO NOT remove the fuel cap with the engine running.
- DO NOT overfill the fuel tank. Allow space for fuel expansion.
- DO NOT refuel the generator while the engine is running.
- DO NOT light a cigarette or smoke when add fuel.
- DO NOT tip engine or equipment at angle which causes fuel to spill.
- If fuel spills, wait until it evaporates before starting engine.
- Keep fuel away from sparks, open flames or other form of ignition (such as match, cigarette, pilot lights, static electric source).
- Store any containers containing gasoline in a well-ventilated area, away from any combustibles or source of ignition.
- Check for fuel leaks after refueling. Never operate the engine if a fuel leak is discovered.



**WARNING**

Starter cord kickback (rapid retraction) will pull hand and arm toward engine faster than you can let go which could cause broken bones, fractures, bruises, or sprains resulting in serious injury.

- When starting engine, pull cord slowly until resistance is felt and then pull rapidly to avoid kickback.
- NEVER start or stop engine with electrical devices plugged in and turned on.



**WARNING**

Running engines produce heat. Severe burns can occur on contact. Combustible material can catch fire on contact.

- DO NOT touch hot muffler area.
- Allow equipment to cool before touching.



**CAUTION**

Exceeding the generator's running capacity can damage the generator and/ or electrical devices connected to it.

- DO NOT overload the generator.
- DO NOT tamper with the governed speed.
- DO NOT modify the generator in any way.
- DO NOT tamper with governor spring, links or other parts to increase engine speed.
- Start generator and let engine stabilize before connecting electrical loads.

## SAFETY LABELS AND DECALS

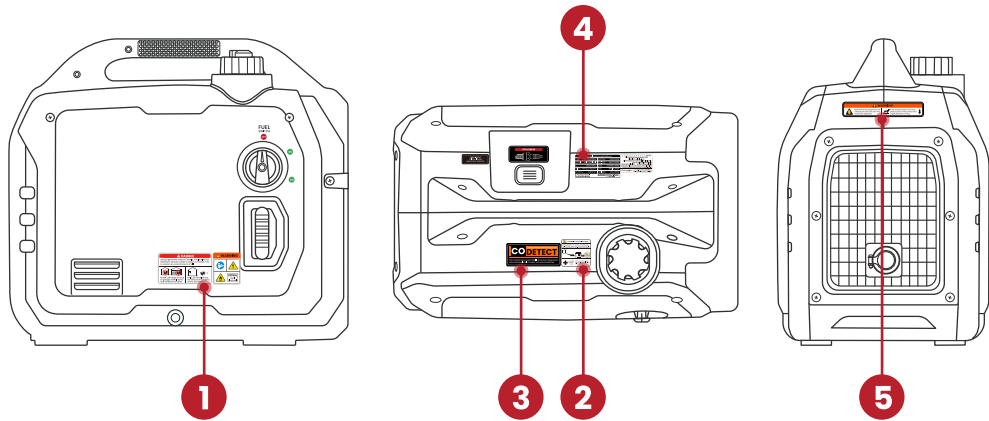

	LABEL	DESCRIPTION
1		Safety Symbols/ CO Danger
2		CO Danger
3		CO DETECT
4		PARAMETERS TABLE
5		HOT SURFACE

# CONTROL PANEL

# 04

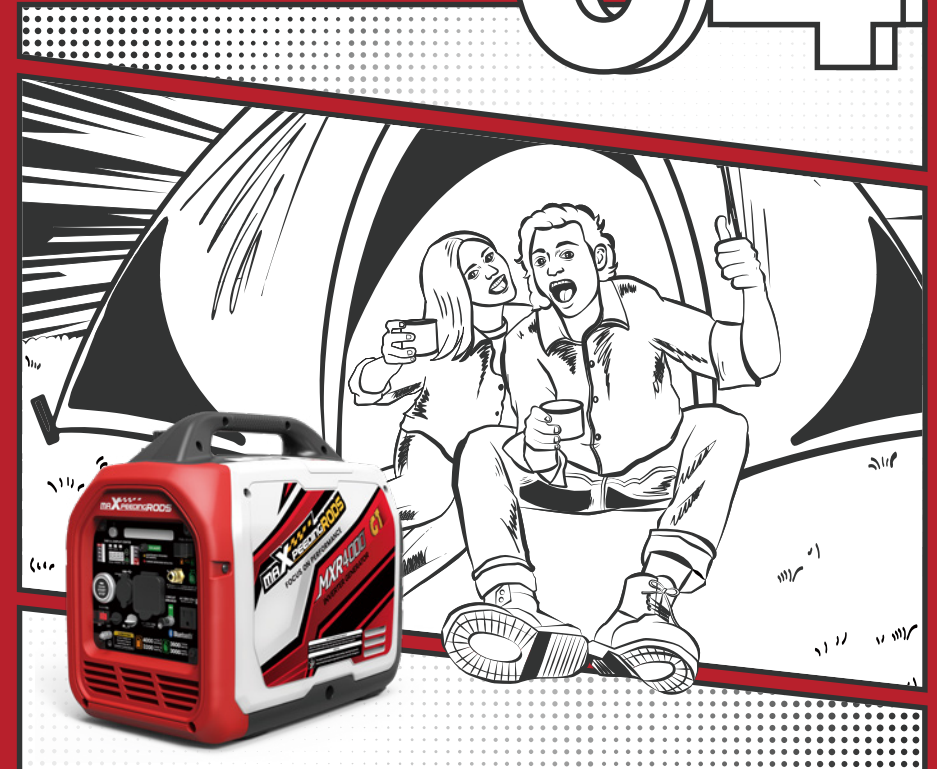



## GENERATOR BASIC FEATURES

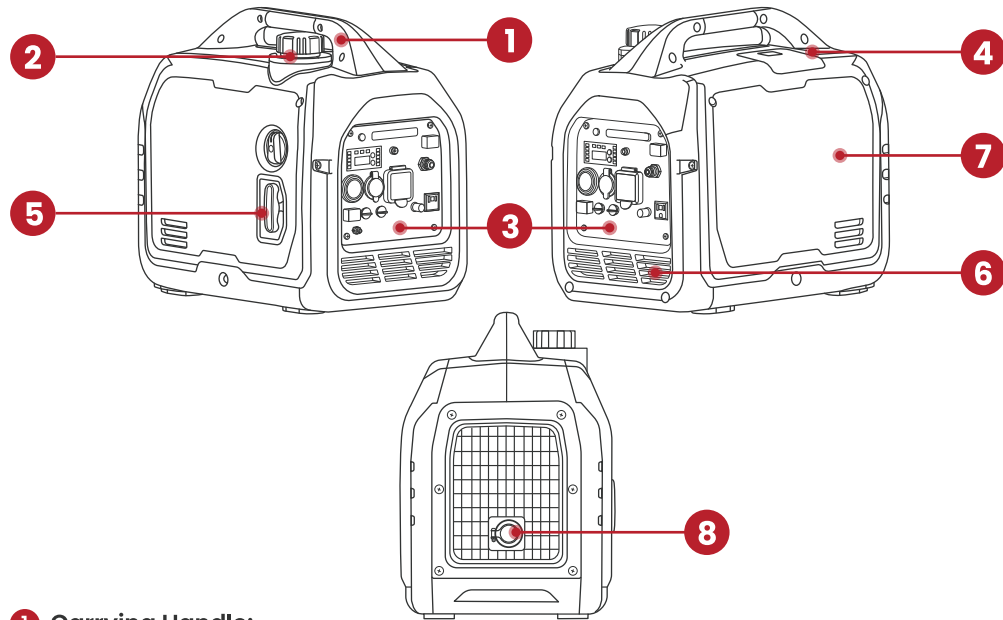

### 1 Carrying Handle:

Used to lift or carry the unit.

### 2 Fuel Cap:

Open the fuel cap to add the gasoline.

### 3 Control Panel:

See Control Panel section.

### 4 Spark Plug Access Cover:

Remove the cover to service the spark plug.

### 5 Recoil Handle:

Pull to start the engine.

### 6 Engine Cooling Vents:

Helps move airflow in unit to regulate engine temperatures.

### 7 Engine Service Panel:

Remove the panel to access the engine for maintenance.

### 8 Muffler and Spark Arrestor:

Avoid contact until the engine is cooled down. The spark arrestor prevents sparks from exiting the muffler. It must be removed for servicing.

## DIGITAL DISPLAY CENTER

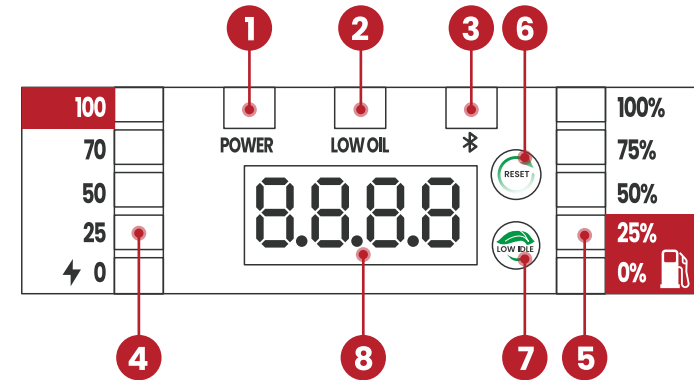

### 1 POWER Indicator Light:

Green light means normal operation; Red light means the generator overload.

### 2 LOW OIL Indicator Light:

Yellow light means the amount of oil is too low.

### 3 Bluetooth® Indicator Light:

Blue light means Bluetooth® is connected.

### 4 LOAD Indicator:

Load power display.

### 5 GASOLINE FUEL METER:

Gasoline fuel level display.

### 6 Reset Switch:

**A.** If the inverter is overloaded, the breaker will trip. Unplug the devices and reduce the load. Push button to reset the circuit.

**B.** You must press the RESET button for 3 seconds before the first time Bluetooth® pairing.

### 7 LOW IDLE:

Open the LOW IDLE mode, lowers the engine speed to match the load to save on fuel and reduce noise levels.

**Note:** When turned to the ON position, the load needs to be reduced by half for use.

### 8 Display Screen:

Scrolling display of voltage, frequency, single running time and accumulated running time.

## CONTROL PANEL

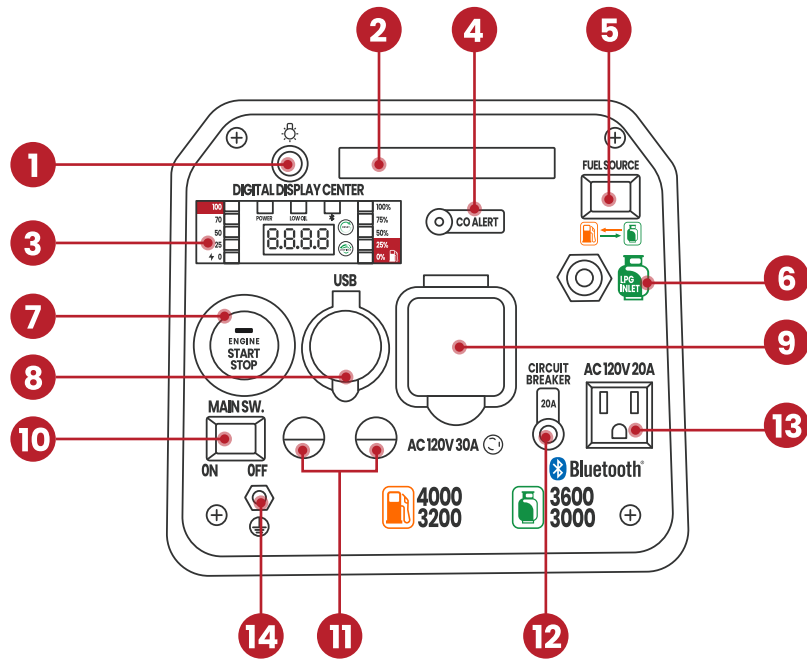

### 1 LIGHT SW:

Press the button once to turn on the light.

### 2 LED LIGHT:

Emergency Light.

### 3 DIGITAL DISPLAY METER with Indicator Lights:

Display voltage output, frequency, fuel level in liters, power output, scrolling display of single running

time and accumulated running time;

It has Low Oil LED, Output Ready LED, Bluetooth® LED Indicator Lights; it is equipped with a LOW IDLE switch and a reset switch.

### 4 CO ALARM:

Flashing red light: dangerous levels of carbon monoxide gas have built up leave immediately until area has aired out. Move generator to well-ventilated area before operation. Flashing yellow light: carbon monoxide sensor malfunction, sensor needs service.

### 5 FUEL SOURCE:

Used to select gasoline or propane operation.

### 6 LPG interface:

When you select LPG fuel, you need to connect the LPG hose.

### 7 START/STOP BOTTON:

Starts and shuts down the generator.

### 8 USB Duplex:

5V DC that come in 3 amps.

### 9 120-VOLT, 30-AMP RECEPTACLE:

The receptacle is capable of carrying a maximum of 30 amps.

### 10 MAIN SWITCH:

Allows power to the starter and panel. Prevents accidental starting.

### 11 PARALLEL CONNECTORS:

To increase AC power output, the connector sockets are used to connect the two same type generator with special paralleling cords. The connector sockets is only used to the communication between the inverters. they can not used for AC power output.

The special parallel kit shall be purchase separately.

The power output of two generators connected in parallel is: the sum of the power of the two generators x 90%.

### 12 20 AMP AC CIRCUIT BREAKER:

Circuit breaker limits the current that can be delivered through the NEMA 5-20R receptacle to 20 Amps.

### 13 120 VOLT AC, 20 AMP NEMA 5-20R RECEPTACLE:

The receptacle is capable of carrying a maximum of 20 amps.

### 14 Ground Terminal:

The ground terminal is used to externally ground the inverter.

## CARBON MONOXIDE SPECIFICATION

CO DETECT technology monitors the accumulation of carbon monoxide (CO), a poisonous gas produced by engine exhaust when the generator is running. If CO Sensor detects unsafe elevated levels of CO gas, it automatically shuts off the engine CO Sensor is not a substitute for an indoor carbon monoxide alarm or for safe operation. DO NOT allow engine exhaust fumes to enter a confined area through windows, doors, vents or other openings. Generators must ALWAYS be used outdoors, far away from occupied buildings with engine exhaust pointed away from people and buildings.

## INFORMATION NOTICE OF Bluetooth® PART

<b>Bluetooth® Part Number</b>	<b>BT2S</b>
<b>FCC ID</b>	<b>2ANDL-BT2S</b>

 **CAUTION**  
Exposure to Radio Frequency Radiation.

This product must be installed and operated with a minimum distance of 20 cm between the radiator and user body. This transmitter module is authorized only for use in device where the antenna may be installed such that 20 cm may be maintained between the antenna and users.

Any changes or modifications not expressly approved by the party responsible for compliance could void the user's authority to operate this device.

# ASSEMBLY 05



## UNPACKING

- 1 Set the shipping carton on a solid, flat surface.
- 2 Carefully cut the packing tape on top of the carton.
- 3 Remove everything from the carton except the generator.
- 4 Using the carrying handles of the unit, carefully remove the generator from the box (two people lifting is recommended).

## PACKAGE CONTENTS

Your generator comes with the items listed below.

Inverter Generator	1
Owner Manual	1
Spark Plug Socket Wrench	1
Oil Funnel	1
Screwdriver	1
Generator Dust Cover	1
US Plug	2
Generator Parallel Cables	1
Pressure Relief Valve Kit	1
L5-30P to TT-30R Adapter	1

# BEFORE START THE GENERATOR

# 06



## BEFORE START THE GENERATOR

**Location Selection – Before starting the inverter, avoid exhaust and location hazards by verifying:**

- You have selected a location to operate the inverter that is outdoors and well ventilated.
- You have selected a location with a level and solid surface on which to place the inverter.
- You have selected a location that is at least 6 feet (1.8 m) away from any building, other equipment or combustible material.
- If the inverter is located close to a building, make sure it is not located near any windows, doors and/ or vents.

### Weather

Never operate your inverter outdoors during rain, snow or any combination of weather conditions that could lead to moisture collecting on, in or around the generator.

### Dry Surface

Always operate the inverter on a dry surface free of any moisture.

### No Connected Loads

Make sure the inverter has no connected loads before starting it. To ensure there are no connected loads, unplug any electrical extension cords that are plugged into the control panel receptacles.

## GROUND THE GENERATOR

In order to prevent any damage to the generator caused by electric shock or improper electrical application, it is recommended that the generator is grounded with good conductor with insulating sheath.

- 1 Please use grounding wire with sufficient electrical energy capacity;
- 2 Connect one end of grounding wire reliable to grounding bolt on control panel of the generator set;
- 3 Insert grounding body (iron rod with a diameter of 5 ~ 10mm) 200mm below into the earth and lead it out with conductor;
- 4 Connect the other end of the grounding wire reliable to the led wire of grounding body (see **Fig.3**).

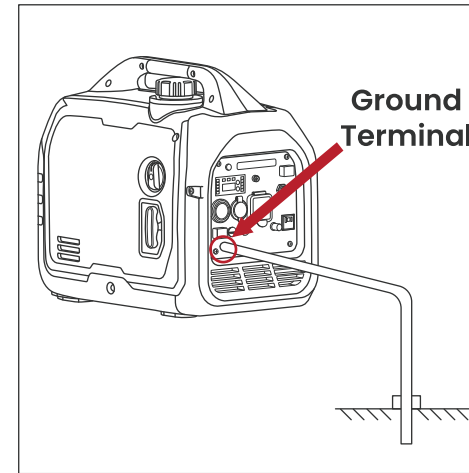

**Fig.3**



### WARNING

Be sure the inverter is properly connected to earth ground before operating.

- The portable generator stator winding is isolated from the frame and from the AC receptacle ground pin; and
- Electrical devices that require a connection between one conductor pin and the grounded receptacle pin may not function properly.

## CONNECT THE BATTERY LINE

### NOTICE

- For the first use, open the side panel and connect the battery line.
- Disconnect the battery line if long storage is required.
- The generator is equipped with a battery charging feature. Once the engine is running, will slowly recharge the battery.

- 1 Loosen the screws and remove the maintenance cover.
- 2 A quick-connect battery plug is pre-installed on the battery. Just connect the battery plug (see **Fig.4**).

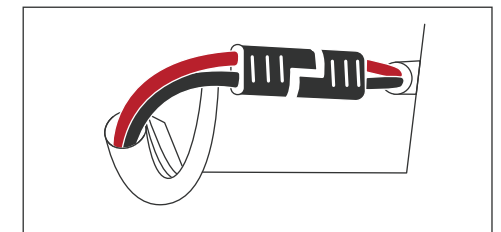

**Fig.4**

## ADD ENGINE OIL

### NOTICE

THIS GENERATOR HAS BEEN SHIPPED WITHOUT OIL. Do not attempt to crank or start engine before it has been properly serviced with recommended oil. Failure to add engine oil before starting will result in serious engine damage.

Recommended oil type for typical use is SAE 10W-30 engine oil. If running the generator in extreme temperatures, refer to the following chart.

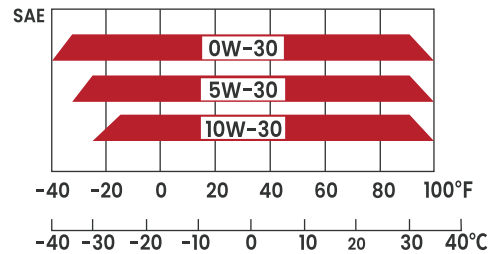

- 1 Place the generator on a flat, level surface.
- 2 Loosen the four screws and remove the maintenance cover (see Fig.5).
- 3 Remove the oil dipstick, and use the oil funnel to add 0.12gal oil. DO NOT OVERFILL (see Fig.6).

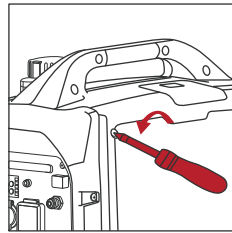

Fig.5

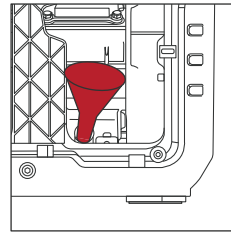

Fig.6

- 4 Check engine oil level before each use and add as needed (see Fig.7).

### NOTICE

DO NOT screw in the dipstick while checking oil level. Oil cannot exceed the upper limit of the oil level.

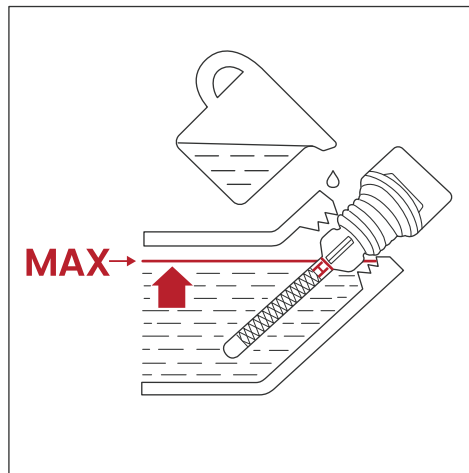

Fig.7

- 5 Tighten the oil dipstick and install the maintenance cover.



### NOTICE

This engine is equipped with a low oil shut-off and will stop when the oil level in the crankcase falls below the threshold level.

## ADD FUEL: GASOLINE

### WARNING



Never refuel the inverter while the engine is running.



Always turn the engine off and allow the inverter to cool before refueling.

**Required Gasoline** – Only use gasoline that meets the following requirements:

- Unleaded gasoline only
- Gasoline with maximum 10% ethanol added
- Gasoline with an 87 octane rating or higher

**DO NOT** use E85 or E15.

**DO NOT** use a gasoline oil mix.

**DO NOT** modify the engine to run on alternate fuels.

**DO NOT** fuel indoors.

**DO NOT** create a spark or flame while fueling.

**Filling the Fuel Tank** – Follow the steps below to fill the fuel tank:

Fuel Tank Capacity: 1.1gal

1. Shut off the generator.
2. Allow the generator to cool down so all surface areas of the muffler and engine are cool to the touch.
3. Move the generator to a flat surface.
4. Clean area around the fuel cap.
5. Remove the fuel cap by rotating counterclockwise.

### NOTICE

Do not overfill the fuel tank. Spilled fuel will damage some plastic parts.

6. Slowly add gasoline into the fuel tank. Be very careful not to overfill the tank. The gasoline level should NOT be higher than the red ring (see Fig.8).

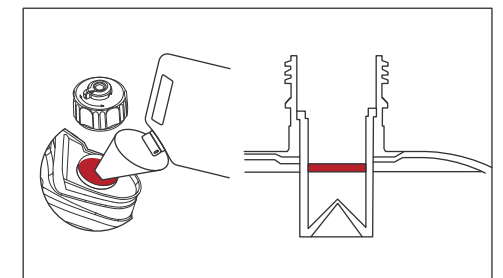
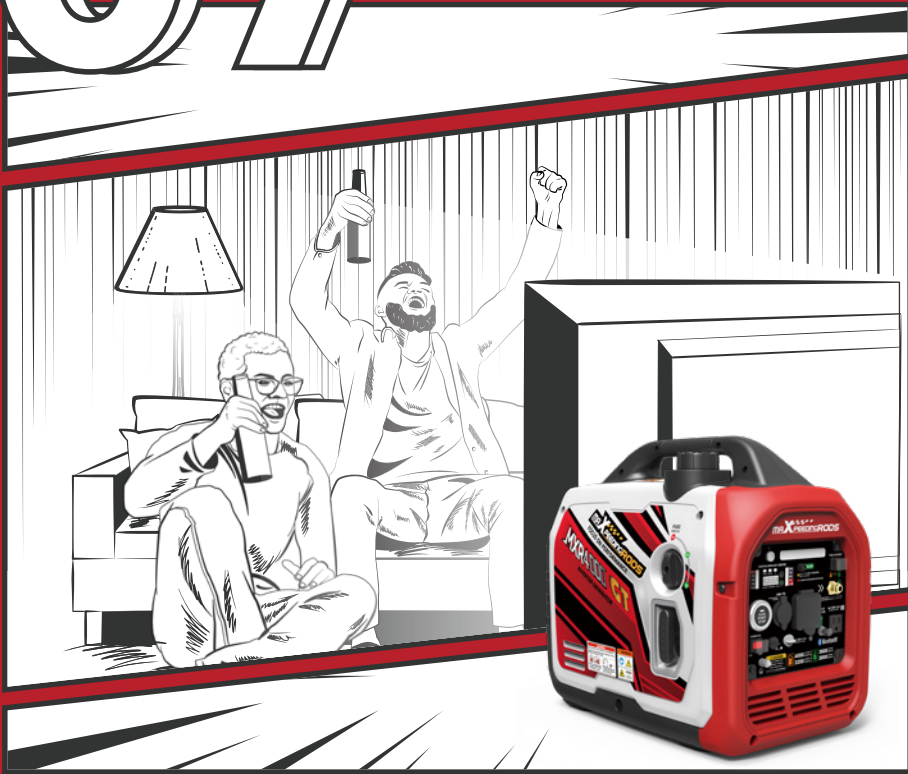

Fig.8

7. Install the fuel cap by rotating clockwise.

# 07 OPERATION THE GENERATOR



## OPERATION THE GENERATOR

### DANGER



Never use the inverter in a location that is wet or damp. Never expose the inverter to rain, snow, water spray or standing water while in use. Protect the inverter from all hazardous weather conditions. Moisture or ice can cause a short circuit or other malfunction in the electrical circuit.



Never operate the inverter in an enclosed area. Engine exhaust contains carbon monoxide. Only operate the inverter outside and away from windows, doors and vents.

- All loads are disconnected from the generator.
- The generator is properly grounded.
- The generator is connected the battery line.

## START THE GENERATOR

### 1 Select fuel

The fuel selector is located on the right side of the front control panel.

- (1) Select gasoline fuel:** Press the fuel switch to the left gasoline position (see **Fig.9**).

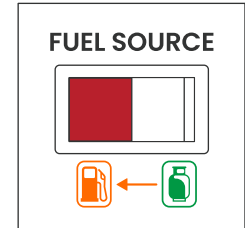

**Fig.9**

### (2) Select LPG Fuel:

**A.**Connect propane hose: Connect the propane hose to both the inlet and the propane tank. Open the propane tank (see **Fig.10**).

**B.**Press the fuel switch to the right LPG position (see **Fig.11**).

**Before attempting to start the inverter, verify the following:**

- The engine is filled with engine oil.
- The generator is situated in a proper location.
- The generator is on a dry surface.

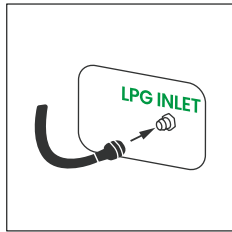

Fig.10

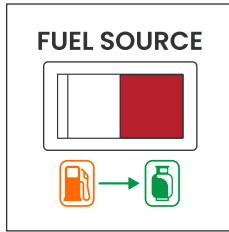

Fig.11

- Turn the fuel switch to the "ON" position (see Fig.12).

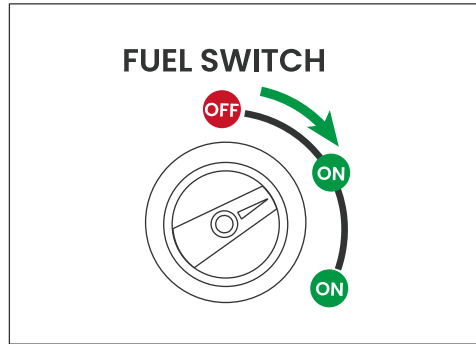

Fig.12

- Press the MAIN switch to the "ON" position (see Fig.13).

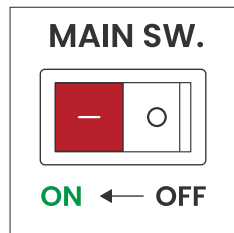

Fig.13

- Make sure LOW IDLE off. (NO green light on).

- Choose the Starting Method.

- Recoil Start:** Firmly grasp and pull the recoil handle slowly until you feel increased resistance, then pull rapidly.

**Tip:** When pulling the hand starter, hold the the generator carrying handle firmly, to prevent the generator from overturning (see Fig.14).

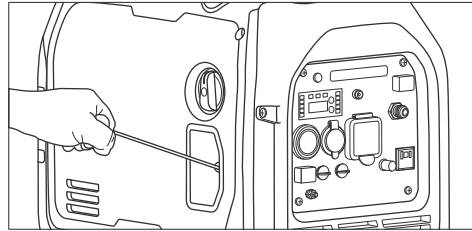

Fig.14

- Electric Start:** Press the start up button down for 1-3 seconds to start the generator (see Fig.15).

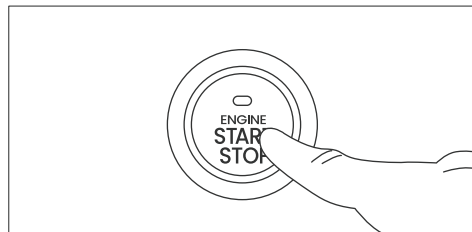

Fig.15

- Bluetooth® Start:** Press the start button on the App to start the generator (see Fig.16).

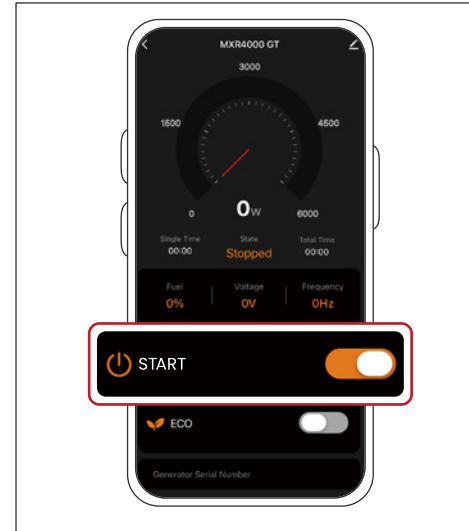

Fig.16

**! DANGER**

Fire and explosion hazard. Always turn the propane tank valve to the fully closed position if not running the generator on propane.

**⚡ WARNING**

WHEN USING THE GENERATOR WITH LPG MAKESURE THERE IS NO POSSIBLE IGNITION SOURCECLOSE TO THE GENERATOR.

- Before using, make sure all of the LPG connectors and hoses are well connected and sealed.
- Connect electrical devices to the generator ONLY after the engine runs

smoothly. (There may be remnant gasoline in the carburetor; this can cause unsteady engine performance for several minutes).

- If the propane gas leaks, shut off the LPG supply first and then quickly unplug or turn off any electrical devices powered by the unit.

**NOTICE**

If it is difficult to start the generator with LPG fuel, you can choose to start the generator with gasoline first and then switch the fuel from gasoline to LPG when there is no load.

**STOP THE GENERATOR**

During normal operation, use the following steps to stop your generator:

- Remove all the loads out of the output.
- A.** Press "START UP" Button to stop the generator.  
**B.** Press the stop button on the App to stop the generator.
- Press the MAIN switch to the "OFF" position.
- Turn the fuel switch to the "OFF" position.



## Bluetooth® FUNCTION

The inverter generator is connected to a smartphone via a Bluetooth® connection.

**Recommend:** In the absence of obstacles, the connection range between the generator and the smartphone < 80 feet.

### NOTICE

The range between your Bluetooth® enabled smartphone and the generator can be maximized when there is a clear, obstruction free, line-of-sight between devices. The connection distance is also affected by the type of smartphone used and the surrounding environment, structures, and electronic interference.

### The App is able to do the following convenient functions:

1. Remote start or stop: Can start or stop the generator from a distance (see **Fig.17**).

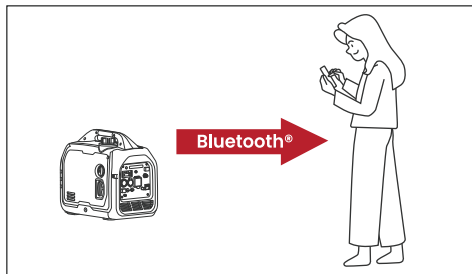

**Fig.17**

2. Generator IOW IDLE mode on/off: The IOW IDLE mode of the generator can be turned on or off from a distance.

3. The App interface can display: output power, remaining gasoline, voltage frequency, cumulative running time, single running time, generator status and generator serial number.

## PAIRING App

**NOTE:** First time only, Bluetooth® pairing required.

### Before Pairing App

1. Make sure the generator is filled with the right amount of oil, gasoline/LPG;
2. Make sure the battery power is sufficient;
3. Open the main switch on the generator panel before using App.

- 1 (1) Scan the QR code to download the app(see Fig.18).  
(2) Search for "Maxspeedingrods" in the app store.



**Fig.18**

- 3 Turn on the Bluetooth® on your smartphone (see **Fig.20**).

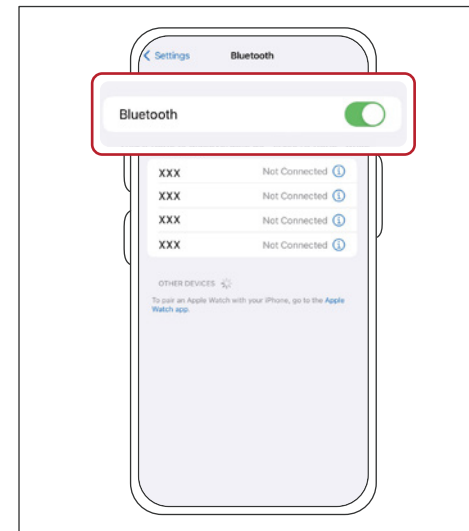

**Fig.20**

- 2 Open the App, register an account, Log in your account (see **Fig.19**).

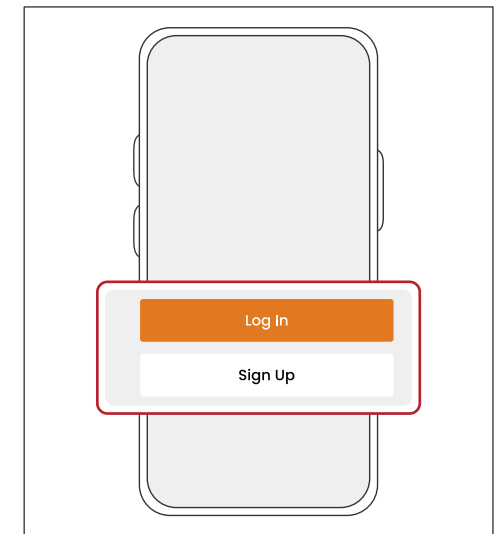

**Fig.19**

- 4 Press the RESET button on the control panel for 3 seconds (see **Fig.21**).



**Fig.21**

- 5 Click "ADD" to add the generator(see Fig.22).

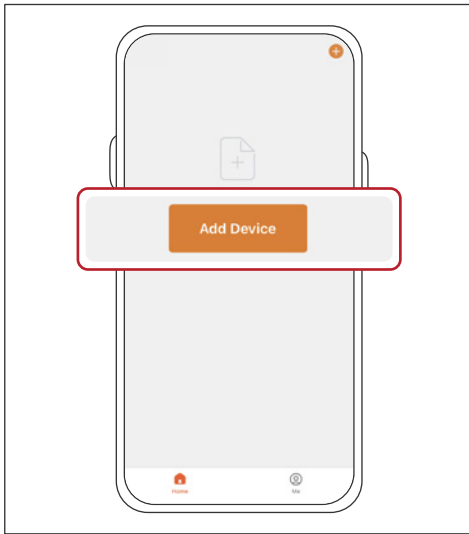

Fig.22

- 6 The generator added successfully (see Fig.23).

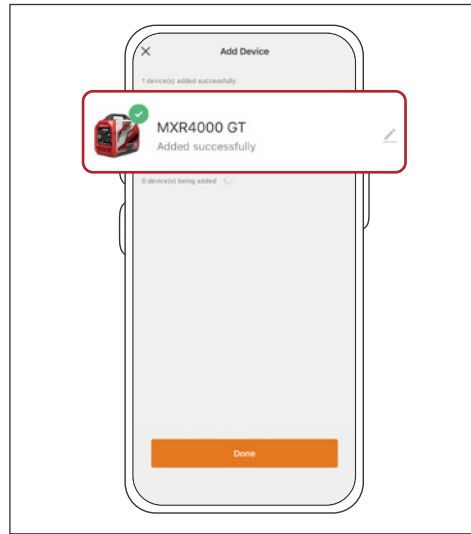

Fig.23

## App CONTROL INTERFACE



- 1 **Output Power:**  
The total power of the appliances connected to the generator.  
**Note:** Not overload.

- 2 **Remain Gasoline:**  
Display of the amount of gasoline remaining in the generator fuel tank.

- 3 **Single Running Time:**  
Timer function, single run time after each start of the generator.

- 4 **Total Working Time**  
Shows the life of the generator, the total running time of the generator since the factory.

- 5 **State**  
**Working State:** Working state is displayed when the generator is successfully started;

**Stopping State:** Stopping state is displayed when the generator is shut down;

**Error State:** Error state is displayed when an error code appears in App.

- 6 **Voltage**  
Output voltage of the generator.

- 7 **Frequency**  
Output frequency of generator

- 8 **Generator Serial Number:**  
Generator Serial Number: Generator production batch number, you can provide to the customer service during after-sales service.

### Disclaimer

#### Bluetooth®

1.The Bluetooth® word mark and logos are registered trademarks owned by Bluetooth® SIG, Inc. and any use of such marks by Chongqing Guoyu Technology Co., Ltd is under license.

2. Google Play and the Google Play logo are trademarks of Google Inc. Android is a trademark of Google Inc.

3. Apple, the Apple logo are trademarks of Apple Inc., registered in the U.S. and other countries. App Store is a service mark of Apple Inc., registered in the U.S. and other countries.

iOS is a trademark or registered trademark of Cisco in the U.S. and other countries and is used under license.

## App ERROR CODE

ERROR CODE	DESCRIPTION	SOLUTION
01	Overload Protection	Unplug some devices, press the reset button; If the error is still reported, the inverter faulty; Contact customer service.
02	Short-circuit Protection	Unplug some devices, press the reset button.
03	Undervoltage Protection	Contact customer service.
04	High Busbar	Turn off the generator, wait for 5minutes, then restart the generator; If the error is still reported, the inverter faulty; Contact customer service.
05	Low Busbar	Unplug some devices, press the reset button; If the error is still reported, the inverter faulty; Contact customer service.
06	Zero Point Error	Unplug some devices, press the reset button; If the error is still reported, the inverter faulty; Contact customer service.
07	Temperature Protection	The air inlet or exhaust outlet is blocked, remove the obstruction.

ERROR CODE	DESCRIPTION	SOLUTION
08	Hardware Overcurrent	Unplug some devices, press the reset button; If the error is still reported, the inverter faulty; Contact customer service.
09	Frequency Mismatch	The voltage and frequency of the load appliance do not match the generator, so use a matching appliance.
0A	Low Rotational Speed	When no load, switch the ECO switch, if there is a significant change in speed, the engine is abnormal.
0B	Voltage Asymmetry	1.problems caused by certain special appliances; 2. The inverter faulty; Contact customer service.
0C	Command Close	Unplug some devices, press the reset button; If the error is still reported, the inverter faulty; Contact customer service.
0D	Encryption Error	Contact customer service.
0E	Primary-Secondary Communication Failed	Replace the inverter.
0F	Reserved Code	Contact customer service.

## LOW IDLE MODE

### NOTICE

Always start the generator with LOW IDLE MODE OFF.

The inverter is equipped with an efficiency mode switch to minimize fuel consumption. In efficiency mode, the inverter will sense the load and adjust the engine RPM to the current load requirements. Efficiency mode should be used only after the inverter has been warmed up to operating temperature.

- 1 To turn on the efficiency mode, press the switch to the ON position.
- 2 If no load is present, the inverter RPM will drop down to an idle speed.
- 3 As a load is applied, the inverter will sense the load and engine RPM will increase according to the load applied.
- 4 To run the inverter at maximum power and RPM, press the efficiency mode switch to the OFF position.

## AC RESET

The inverter will trip the breaker and automatically disconnect from the load when the controls sense a predetermined overload condition. The generator engine will continue to run, but there will not be any electrical output.

- 1 Turn off all devices and unplug them from the inverter.
- 2 Press in the reset breaker to reset it until the OVERLOAD LED goes OFF and the OUTPUT READY LED is illuminated.
- 3 Determine the wattage required from the devices being powered by the inverter. Make sure the wattage required does not exceed the maximum output of the inverter.
- 4 Reconnect electrical loads sequentially.

## USE THE GENERATOR

### Service Environment Of the Generator:

- Applicable temperature: -15°C~ 40°C;
- Applicable humidity: below 95%;
- Applicable altitude: regions below 5000 feet.

### Standard Atmospheric Condition:

- Ambient temperature  $T_r$ : 298k (25°C);
- Relative air humidity  $\Phi_r$ : 30%;
- Absolute atmospheric pressure  $P_r$ : 100kPa.

### When actual environmental condition is inconsistent with the condition of output power of the generator set:

- Every 5°C of increase in ambient temperature will reduce the power of generator by about 2%.
- Every 30% of increase in relative humidity of air will reduce the power of generator by about 1.5%.
- Every 1000 feet rising of ASL will reduce the power the generator by about 4.5%.

## USE GENERATOR AT HIGH ALTITUDE

- 1 The density of air at high altitudes is lower than at sea level. Engine power is reduced as the air mass and air-fuel ratio decrease. Output will be reduced approximately 4.5% for every 1000 feet of increased altitude from sea level.
- 2 At high altitudes increased exhaust emissions can also result due to

the increased enrichment of the air fuel ratio. Other high altitude issues can include hard starting, increased fuel consumption and spark plug fouling.

- 3 The performance of gasoline engines can be improved by replacing the carburetor with a slightly smaller main injector or by adjusting the adjusting screw. If you often use the generator at an altitude of more than 1000 feet, you can buy special high-altitude parts to replace for use. Otherwise, the load power should be reduced to use the generator.
- 4 Even with the suitable carburetor, a 1000 feet rise in altitude reduces petrol engine power by about 4.5%. Without the replacement of a suitable carburetor, this decline would be even greater.

### NOTICE

If a carburetor suitable for high altitude use is fitted to a gasoline engine for low altitude use, too thin mixture will reduce the power output of the gasoline engine, cause overheat or even serious damage.

## EXTENSION CORDS



### WARNING

Fire and electrocution hazard. Never use worn or damaged extension cords. Damaged or overloaded extension cords could overheat, arc, and burn resulting in death or serious injury.

Long or thin cords can drain the power provided to an electrical device by the generator. Refer to the following chart in determining the necessary gauge extension cord for each of your devices.

DEVICE REQUIREMENTS		LENGTH OF EXTENSION CORD (FEET)							
Amps	Watts	10	20	30	40	50	60	80	100
5	600	20	18	16	14	12	12	10	10
10	1200	18	16	14	12	12	10	10	8
15	1800	16	14	12	12	10	10	8	8
20	2400	14	12	12	10	10	8	8	6
25	3000	12	12	10	10	8	8	6	6
30	3600	12	10	10	8	8	6	6	6
35	4200	10	10	8	8	6	6	6	6

Example: total amps up to 30a, length of extension cord up to 50 feet, so the extension cord wire size is 8AWG.

## CONNECT TO HOUSEHOLD POWER SUPPLY

1. When the generator is connected to household power source as a backup power supply, the connection shall be carried out by a professional electrician or a person familiar with electricity.
2. After connecting the load to the generator, check carefully whether electrical connection is safe and reliable.
3. Improper electrical connection may cause generator damage, burning or fire.
4. Avoid connecting this generator to commercial power outlet.

Generators cannot be used in parallel with the home grid. As shown below (see **Fig.24**).

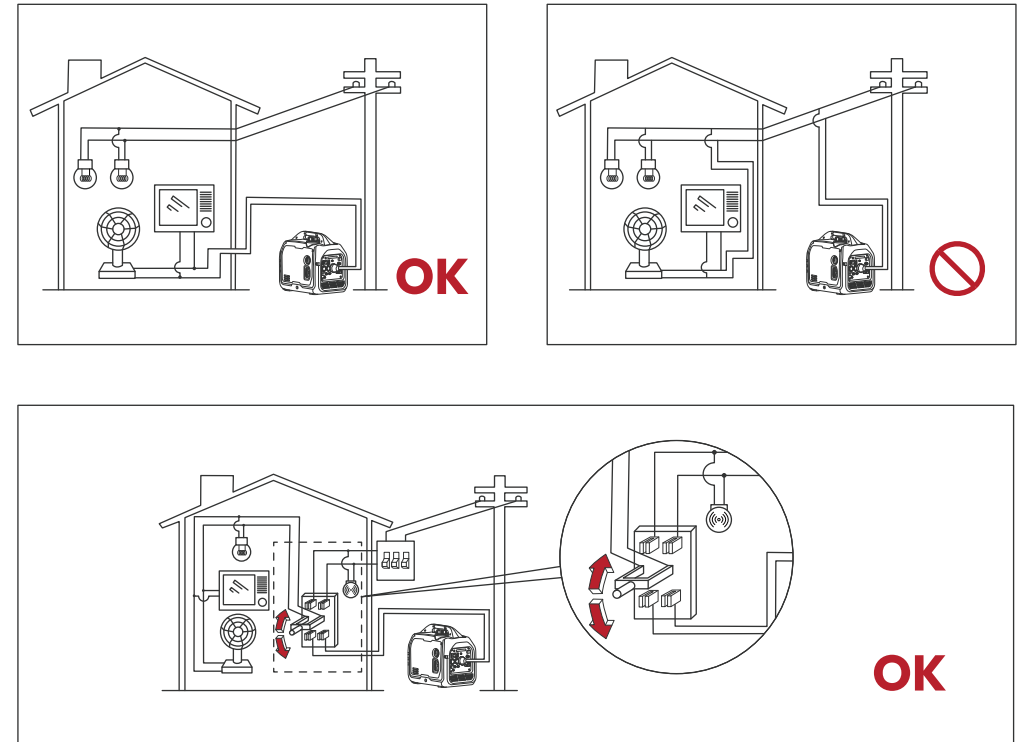

**Fig.24**

## CONNECTION OF AC POWER

### WARNING

All electrical equipment shall be disconnected before inserting the plug.

#### Make sure before starting the generator :

1. The total power of the load apparatus (the sum of resistive, capacitive and inductive load) shall not exceed the rated power of the generator. Exceeding the generator's wattage/ampere capacity can damage the generator and/or electrical devices connected to it.

2. Make sure the generator can supply enough continuous (running) and surge (starting) watts for the items you will power at the same time.

3. Appliance and power tool manufacturers usually list rating information near the model or serial number.

4. Before increasing engine speed, energy-saving switch must be switched to "OFF" . If more than one load or electrical equipment is connected to the generator set, remember that the one with the highest starting load is connected first, and the one with the lowest starting current is connected last (see **Fig.25**).

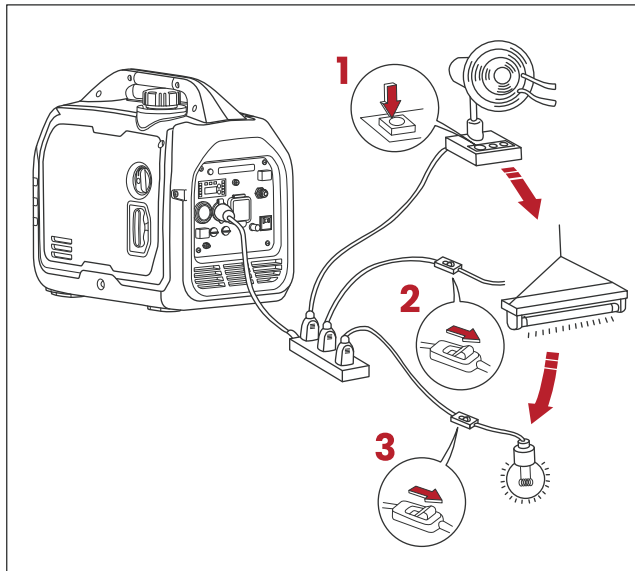

**Fig.25**

#### To determine power requirements:

1. Select the items you will power at the same time.
2. Total the continuous (running) watts of these items. This is the amount of power the generator must produce to keep the items running.
3. Estimate how many surge (starting) watts you will need. Surge wattage is the short burst of power needed to start electric motor-driven tools or appliances such as a circular saw or refrigerator. Because not all motors start at the same time, total surge watts can be estimated by adding only the item(s) with the highest additional surge watts to the total rated watts from step.

#### For example

TOOL OR APPLIANCE	RATED (RUNNING) WATTS	STARTING (PEAK) WATTS
RV Refrigerator	200	600
Coffee Maker	600	
Electric fan	200	600
Radio	200	
Tool or Appliance	1200 Total Running Watts	1200 Highest Starting Watts
<b>1200 Total Running Watts + 1200 Highest Starting Watts = Total Starting Watts Need 2400</b>		
*Wattages listed are approximate. Verify actual wattage.		

In general, capacitive and inductive load, especially motor drive device, produce a large starting current when starting up. The following table is for your reference when you connect these electrical appliances to the generator set.

Type	Wattage		Typical Equipment	Example		
	Start	Rated		Device	Start	Rated
Incandescent Lamp Heating Apparatus	x1	x1	Incandescent Lamp/ TV set	Incandescent Lamp 100w	100VA (W)	100VA (W)
Fluorescent Lamp	x2	x1.5	Fluorescent Lamp	Fluorescent Lamp 40W	80VA (W)	60VA (W)
Electromotor Drive Device	x3-5	x2	Refrigerator/ Electric Fan	Refrigerator 150W	450- 750VA (W)	300VA (W)

\*Wattages listed are approximate. Verify actual wattage.

# MAINTENANCE 08

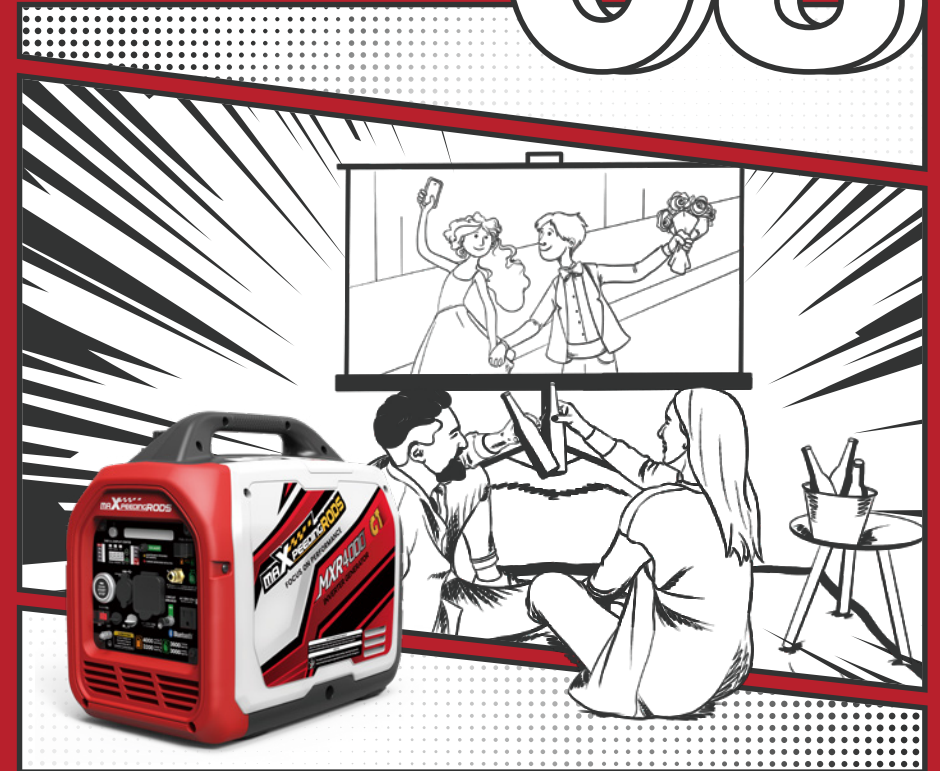

## MAINTENANCE



### WARNING

TO PREVENT SERIOUS INJURY FROM ACCIDENTAL STARTING: Turn the Combination Switch of the equipment to its "OFF" position, wait for the engine to cool, and disconnect the spark plug cap before performing any inspection, maintenance, or cleaning procedures.

TO PREVENT SERIOUS INJURY FROM EQUIPMENT FAILURE: Do not use damaged equipment. If abnormal noise, vibration, or excess smoking occurs, have the problem corrected before further use.

Follow all service instructions in this manual.

The engine may fail critically if not serviced properly.



### WARNING

Many maintenance procedures, including any not detailed in this manual, will need to be performed by a qualified technician for safety. If you have any doubts about your ability to safely service the equipment or engine, have a qualified technician service the equipment instead.

**Note:** This maintenance schedule is intended solely as a general guide. If performance decreases or if equipment operates unusually, check systems immediately. The maintenance needs of each piece of equipment will differ depending on factors such as duty cycle, temperature, air quality, fuel quality, and other factors.

**Note:** The following procedures are in addition to the regular checks and maintenance explained as part of the regular operation of the engine and equipment.

Maintenance Cycle		Item	Each	First in 1 month or 20 hours	every 3 months or every 50 hours	1 years or every 100 hours	
			Each	First in 1 month or 20 hours	every 3 months or every 50 hours	1 years or every 100 hours	
Engine Oil*	Check-Fill	✓					
	Replace		✓	✓			
Gearbox gear Oil(if any)**	Check Oil	✓					
	Replace		✓	✓			
Air Filter Element*	Inspection	✓					
	Clean		✓				
	Replace				✓		
Sediment Cup (if any)**	Clean					✓	
Spark Plug*	Clean-Adjust					✓	
Spark Eliminator*	Clean				✓		
Idling Speed (if any)**	Check-Adjust					✓	
Valve Clearance**	Check-Adjust					✓	
Fuel Tank and Fuel Filter**	Clean					✓	
Fuel Line**	Inspection	Every two years (Please replace if ecessary)					
Cylinder Head, Piston**	Remove carbon deposit**	Displacement < 225cc, every 125 hours; displacement capacity ≥ 225cc, every 250 hours.					
<p>* These items shall be replaced if necessary;</p> <p>** These items shall be maintained by the dealer authorized by the Company, unless the user has proper tools and maintenance ability.</p>							



## CHANGE ENGINE OIL



### WARNING

Oil is very hot during operation and can cause burns. Wait for engine to cool before changing oil.

### NOTICE

- Always maintain proper engine oil level. Failure to maintain proper engine oil level could result in severe damage to the engine and/or shorten the life of the engine.
- Always use the specified engine oil. Failure to use the specified engine oil can cause accelerated wear and/or shorten the life of the engine.

- 1 Always operate or maintain the generator on a flat surface.
- 2 Stop the engine.
- 3 Let engine sit and cool for several minutes.
- 4 Open the side maintenance cover.

- 5 Remove the oil dipstick and tilt the generator to discharge the oil (see **Fig.26**).

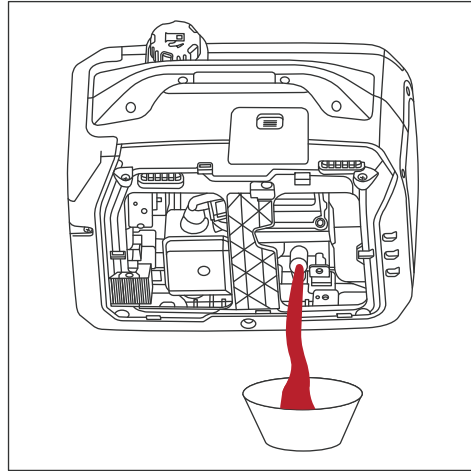

**Fig.26**

- 6 Fill the new engine oil and check the oil level.
- 7 Tighten the oil dipstick.
- 8 Close the side maintenance cover.

### NOTICE

- Long-term and frequent skin contact with engine oil may lead to skin cancer. Although this is not inevitable, it is recommended to wash the skin exposed to engine oil immediately and thoroughly with soap and water.
- From the perspective of environmental protection, please properly dispose of the used engine oil after use. We strongly recommend that you put the waste engine oil in a sealed container and send it to the local service station or waste oil recovery center.
- **Remember:** do not throw it into a garbage or dump it on the ground or in a ditch.

## CLEAN THE AIR FILTER

### NOTICE

- Dirty air filter will affect air flowing into carburetor. To prevent carburetor failure, please regularly maintain the air filter. If used in dusty environment, it should be maintained more frequently.
- It is forbidden to start the generator without installing an air filter, otherwise the gasoline engine will be worn-out quickly.

The air filter must be cleaned after every 50 hours of use or 3 months (frequency should be increased if inverter is operated in a dusty environment).

- 1 Turn off the generator and let it cool for several minutes if running.
- 2 Open the side maintenance cover.
- 3 Unscrew the bolts on air filter cover.
- 4 Remove the foam element from the air cleaner housing (see **Fig.27**).

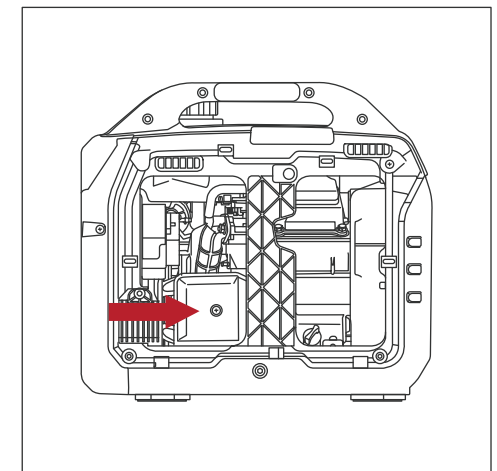

**Fig.27**

- Wash the foam air filter element by submerging the element in a solution of household detergent soap and warm water. Slowly squeeze the foam to thoroughly clean.

**NOTICE**

NEVER twist or tear the foam air filter element during cleaning or drying. Only apply slow but firm squeezing action.

- Rinse in clean water by submerging the air filter element in fresh water and applying a slow squeezing action.

**NOTICE**

Never dispose of soap cleaning solution used to clean the air filter by dumping the solution into a sewer, on the ground, or into ground water or waterways. Always be environmentally responsible. Follow the guidelines or other governmental agencies for proper disposal of hazardous materials. Consult local authorities or reclamation facility.

- Dispose of used soap cleaning solution properly.
- Dry the air filter element by again applying a slow firm squeezing action.

- Return the air filter element to its position in the air cleaner housing.
- Install the air cleaner cover, making sure the tabs lock into place.
- Install the engine service panel.

**REPLACE THE SPARK PLUG**

Please replace the spark plug in accordance with the original specification: **A5RTC**.

- Stop the generator and let it cool for several.
- Move the generator to a flat, level surface.
- Slide the spark plug access cover off the housing (see **Fig.28**).

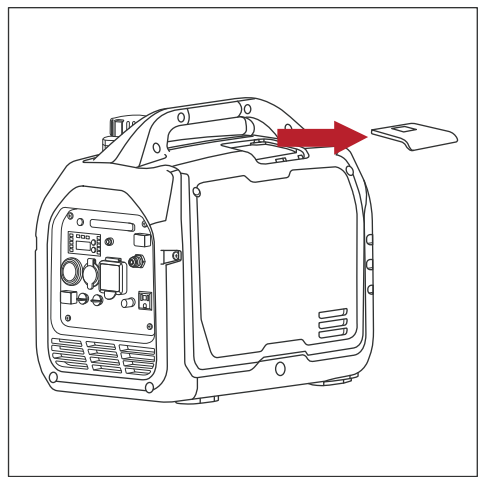

**Fig.28**

- Remove the spark plug boot by firmly pulling the plastic spark plug boot handle directly away from the engine.

**NOTICE**

Never apply any side load or move the spark plug laterally when removing the spark plug. Applying a side load or moving the spark plug laterally may crack and damage the spark plug boot.

- Using the spark plug socket wrench provided, remove the spark plug from the cylinder head (see **Fig.29**).

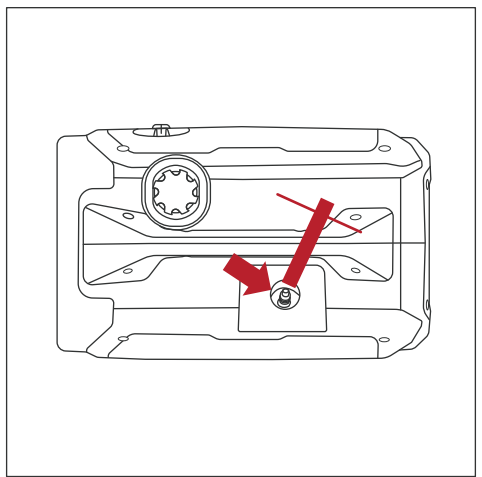

**Fig.29**

- Place a clean rag over the opening created by the removal of the spark plug to make sure no dirt can get into the combustion chamber.

- Inspect the spark plug for:**
  - Cracked or chipped insulator
  - Excessive wear
  - Spark plug gap of 0.032 inch. (0.80 mm)

If the spark plug fails any one of the conditions listed above, replace the plug.

**NOTICE**

Only use the recommended spark plug. Using a non-recommended spark plug could result in damage to the engine.

**Install the spark plug by carefully following the steps outlined below:**

- Carefully insert the spark plug back into the cylinder head. Hand-thread the spark plug until it bottoms out.
- Using the spark plug socket wrench provided, turn the spark plug to ensure it is fully seated.
- Replace the spark plug boot, making sure the boot fully engages the spark plug's tip.
- Install the spark plug access cover.

## DRAIN THE GASOLINE

- 1 Remove the engine service panel to access the carburetor.
- 2 Locate the clear plastic hose from the float that is exiting out the bottom of the inverter, and place a suitable container under it to catch the drained fuel.
- 3 Turn the fuel switch to the "ON" position.
- 4 Loosen the float bowl drain screw until fuel is seen draining from the float bowl (see **Fig.30**).

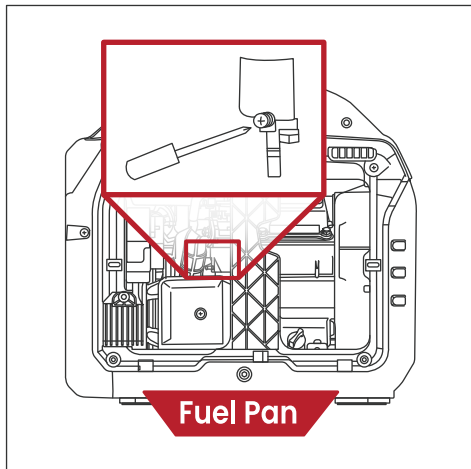

**Fig.30**

- 5 Allow fuel to drain into the container, and then tighten the float bowl drain screw.

## NOTICE

Never dispose of fuel by dumping fuel into a sewer, on the ground, or into groundwater or waterways. Always be environmentally responsible. Follow the guidelines or other governmental agencies for proper disposal of hazardous materials. Consult local authorities or reclamation facility.

- 6 Install the engine service panel.

## CLEAN THE SPARK ARRESTOR

Check and clean the spark arrestor after every 50 hours of use or 3 months.

- 1 Stop the inverter and let it cool for several minutes if running.
- 2 Move the inverter to a flat, level surface.
- 3 Remove the screws holding the muffler cover in place (see **Fig.31**).
- 4 Loosen the clamp holding the spark arrestor onto the muffler.
- 5 Slide the spark arrestor band clamp off the spark arrestor screen.
- 6 Pull the spark arrestor screen off the muffler exhaust pipe.

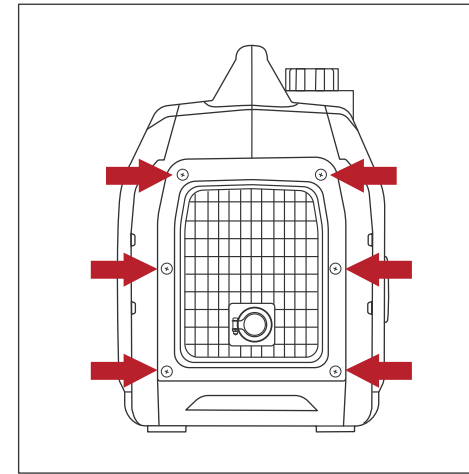

**Fig.31**

- 7 Using a wire brush, remove any dirt and debris that may have collected on the spark arrestor screen.
- 8 If the spark arrestor screen shows signs of wear (rips, tears or large openings in the screen), replace the spark arrestor screen.
- 9 **Install the spark arrestor components in the following order:**
  - A. Place spark arrestor screen over the muffler exhaust pipe. Push on the screen until it fully bottoms out.
  - B. Place the spark arrestor band clamp over the screen and tighten with a flathead screwdriver.
- 10 Replace the discharge gate.

## TRANSPORT THE GENERATOR

### NOTICE

- Fire hazard. DO NOT turn the generator upside down. Fuel or oil can leak and damage to the generator may occur.
- Avoid direct sunlight inside a vehicle. If the generator is left in an enclosed vehicle for many hours, the high temperature could cause the fuel to vaporize and result in a possible explosion.

- 1 Turn off the generator, tighten the fuel cap, and allow the generator to cool a minimum of 30 minutes.
- 2 Only use the generator's fixed handle(s) to lift the unit or attach any load restraints such as ropes or tie-down straps. Do not attempt to lift or secure the generator by holding onto any of its other components.
- 3 Keep the unit level and upright during transport to minimize the possibility of fuel leakage or, if possible, drain the fuel or run the engine until the fuel tank is empty before transport.

## STORAGE THE GENERATOR



### WARNING

- In order to avoid burning or fire caused by contact with high-temperature parts of the generator, the generator must be cooled before storage. (Turn off the generator and allow the unit to cool a minimum of 30 minutes.)
- NEVER place any type of storage cover on the generator while it is still hot. Do not obstruct any ventilation openings.

Follow the procedures below for properly storing your generator. We highly recommend running your generator once a month for 20 to 30 minutes. Plug in a small load in to ensure there is proper power output.

STORAGE PERIOD	STORAGE PREPARATION
For Short Periods (Less than 30 days)	<ol style="list-style-type: none"> <li>1. Turn off the generator, allow the generator to cool.</li> <li>2. Add fuel stabilizer to the gasoline remaining in the tank.</li> <li>3. Place the generator set in a clean and dry area.</li> </ol>
For long Periods (Over 30 Days)	<ol style="list-style-type: none"> <li>1. Turn off the generator, allow the generator to cool.</li> <li>2. Drain the fuel tank and carburetor.</li> <li>3. Change the engine oil.</li> <li>4. Remove the spark plug and place about 2 table-spoon of oil in the spark plug opening. While placing a clean rag over the spark plug opening, slowly pull the recoil handle to allow the engine to turn over several times. This will distribute the oil and protect the cylinder wall from corroding during storage.</li> <li>5. Disconnect the battery plug.</li> <li>6. Place the generator set in a clean and dry area.</li> </ol>

# TROUBLE SHOOTING

# 09

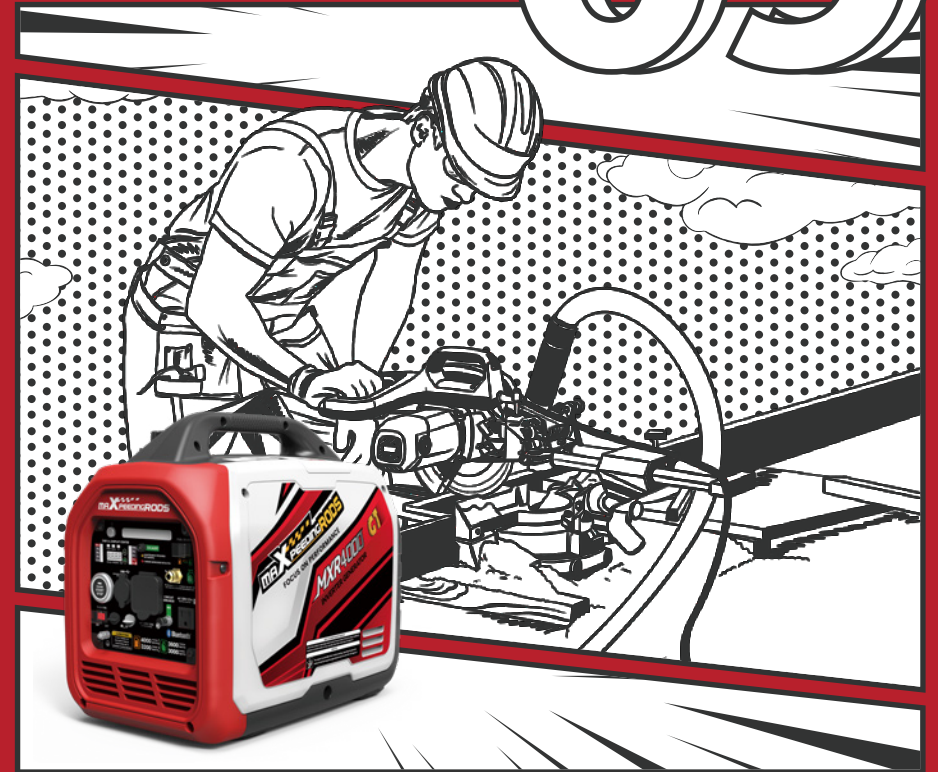

## TROUBLE SHOOTING



Before attempting to service or troubleshoot the generator, the owner or service technician must first read the owner's manual and understand and follow all safety instructions. Failure to follow all instructions may result in conditions that can lead to voiding certification or product warranty, serious personal injury, property damage or even death.

PROBLEM	POSSIBLE CAUSE	SOLUTION
Generator will not start.	Engine is out of fuel.	Add gasoline to the generator.
	Fuel is old or contaminated.	Change fresh fuel.
	Oil is low or added Incorrect oil.	Add or change correct oil.
	Engine switch is set to "OFF" position.	Turn engine switch to the "ON" position.
	Spark plug is dirty or broken.	Clean or replace the spark plug.
	CO sensor not activated or system fault occurred.	Contact customer service.
	Fuel system malfunction, ignition malfunction, choke stuck, etc.	Contact customer service.

PROBLEM	POSSIBLE CAUSE	SOLUTION	
Engine is running, but no electrical output.	Reset breaker is tripped.	Reset the reset breaker.	
	Faulty or defective power cord.	Replace the extension cords.	
	The power cord's plug connector is not fully engaged in the generator's outlet.	Verify plug connector is firmly engaged in the generator's outlet.	
Generator suddenly stops running.	Engine is out of fuel.	Add gasoline to the generator.	
	Low oil shutdown.	Add enough engine oil.	
	Generator overloaded.	Unplug some devices.	
Generator Backfire/Backfiring.	Old or low quality gasoline.	Add correct gasoline.	
	Spark plug cap loose.	Cover the spark plug cap tightly.	
	Defective spark plug.	Replace the spark plug.	
	Dirty air filter.	Clean or replace the air filter.	
	Carburetor blockage.	Clean or replace carburetor.	
	Engine runs rough.	Dirty air filter.	Clean or replace the air filter.
		Generator overloaded.	Unplug some devices.
Carburetor damage.		Replace new carburetor.	

# 10 SCHEMATICS

