



**Assembly Video**

We are here to help!

HOVSCO Help Center: <https://www.hovsco.com/pages/help-center>

Support link: <https://www.hovsco.com/pages/contact>

Phone: (+1)909-990-8695

# User Manual

HOVSCO HovBeta Foldable Electric Bicycle  
(Throttle On Demand)



HovBeta Foldable

## Thank you for purchasing HOVSCO's HovBeta Foldable Ebike

We are so proud to provide you with a quality product that will be enjoyed for many years to come. Before assembling and riding your bike, please ensure that you read and understand this manual completely. If you have questions after reading this manual, please refer to the HOVSCO support or contact us by email or give us a call.

# TABLE OF CONTENTS

USING THIS MANUAL-----	01
GENERAL SAFETY-----	01
CHARGER SAFETY INFORMATION-----	06
SPECIFICATIONS-----	09
INSTALLATION INSTRUCTION-----	10
OPERATION INSTRUCTION-----	34
USER MAINTENANCE AND SERVICE INSTRUCTIONS-----	35
TROUBLESHOOTING-----	40
LIMITED WARRANTY-----	42

## USING THIS MANUAL

It contains information about the product, its equipment, as well as instructions for its operation and maintenance. To ensure safe use and prevent accidents, make sure you read the manual carefully and familiarize yourself with the ebike before using it. There are many warnings and cautions in this manual regarding the safe operation of the machine and the consequences in the event of improper setup, operation, and maintenance. If you have any questions about the information in this manual, you should contact HOVSCO immediately.

Notes, warnings, and cautions contained in the manual and the paragraphs marked with the triangle Caution Symbol at the left should be read carefully. Attention should also be paid to the information beginning with NOTICE in this manual.

Keep this manual, along with any other documents you received with your bike, for future reference, but the content may change at any time without notice. Visit <https://www.hovsco.com/pages/help-center> to download the latest version. HOVSCO makes every effort to ensure the accuracy of its documentation and will not be held liable for any errors or omissions contained therein.

Considering the difficulties of anticipating every situation or condition that may arise when riding, this manual cannot make any guarantees about the safe use of bikes under all conditions. Risks associated with using any bike cannot be predicted or avoided and are solely the responsibility of the rider.

## GENERAL SAFETY

### INSTRUCTIONS PERTAINING TO RISK OF FIRE or ELECTRIC SHOCK

#### VITAL SAFETY INSTRUCTIONS

**WARNING!** Basic precautions should always be followed when using this product, including:

- Read the instructions before use.
- When the product is used near children, close supervision is necessary to reduce the risk of injury.
- Do not put fingers or hands into the product.
- Do not use this product if the flexible power cord or output cable is frayed, has cracked insulation, or shows other signs of damage.
- The equipment should not be used at temperatures below -4°F (-20°C) or above 149°F (65°C).
- The battery should be charged at temperatures between 32°F (0°C) and 86°F (30°C). Do not charge the battery at temperatures outside of this range.

**WARNING!** It is your responsibility to comply with all traffic laws and to use the proper equipment. This includes wearing the proper clothing and maintaining your bike.

Comply with all local bicycle traffic laws and regulations.

Be sure to obey local laws regarding bicycle lighting, bicycle licensing, bicycle path and trail use, helmet laws, child cycling laws, and special bicycle traffic laws. It is your responsibility to know and obey your local laws.

- Always wear a properly fitted helmet that covers your forehead when riding a bike. Specific safety devices are required in many locations. You are responsible for familiarizing yourself with the local laws, rules, and regulations where you ride, including equipping yourself and your bike accordingly.
- A rider's weight and luggage should not exceed 450lbs/204kg unless otherwise stated.
- Before you ride your bike, always check to make sure everything is working properly and correctly aligned.
- Become familiar with your bicycle's controls, such as brakes, pedals, shifting, etc.
- When pedaling, keep all body parts and obtrusive objects clear of the sharp chain rings. Wear proper clothing to prevent injury.
- While riding, remember you are sharing the road or path with others. i.e. motorists, pedestrians and other cyclists.
- Always ride defensively. Assume others don't see you and expect the unexpected.
- Always be aware of your surroundings. Be alert and responsive to:

- Motor vehicles of all kinds and from all directions.
- Unexpected movements of obstacles.
- Nearby pedestrians.
- Children and animals in the area.
- Imperfections on bike paths or paved roads such as potholes, uneven surfaces, loose gravel construction, and debris.
- Warnings, hazards, and yield signs.

- Make use of designated bike lanes when available, and ride traffic-directed.
- Always stop at stop signs and traffic lights.
- Before continuing on, look both ways at street intersections after coming to a complete stop.
- Use official hand signals when turning or stopping.
- Do not wear headphones while riding.
- Don't hold onto another vehicle.
- Avoid weaving through traffic or making sudden movements or turns.
- Cyclists are subject to the same right-of-way rules as motorists. A bicyclist should always be prepared to yield.
- Never ride under the influence of alcohol or drugs.
- Avoid riding in bad weather when visibility is obscured, for example, at dawn, dusk, or at night. Such conditions increase the risk of an accident.
-

### Wet Weather

It is recommended to not ride in wet weather if avoidable. Ride in wet weather only if necessary.

Using an electric bike in heavy rain or in streams is not recommended. Do not immerse or submerge this product in water or liquid as the electrical system could be damaged.

- Use this bicycle with caution in wet weather.
- Decrease your speed in slippery conditions to help you control the bike.
- It takes longer to slow down and come to a stop in wet conditions than in dry conditions.
- Make sure you are visible to others on the road. Wear reflective clothes and use approved safety lights.
- In the rain, road hazards are harder to see; take caution.

### NIGHT RIDING

When riding at night, cyclists should exercise extra caution. Night riding can be more dangerous than riding in the daylight for bicyclists because motorists and pedestrians have a difficult time seeing them.

Those who are aware of the increased risks should take extra precaution when riding at dusk, at night, or when drawing. It is important to wear appropriate gear and use specialized equipment when riding in unfavorable conditions to reduce the risk of injury.

**Warning!** Do not rely on reflectors as a substitute for illumination. If the necessary lights and reflective gear aren't used, cyclists are virtually invisible to other cyclists and motorists. Be sure to use reflectors and lights to make yourself visible if you're riding at night. Insufficient lighting can lead to serious injury or death. As a moving cyclist, reflectors are designed to reflect off of car and street lights to help you become more visible and recognizable when riding.

**Caution!** Regularly inspect the reflectors and mounting brackets of your reflectors to ensure they are straight, secure, and clean. Make sure you comply with all local laws regarding night riding. The following are recommended.

- Wear light-colored, reflective clothing and accessories to enhance your visibility. There are plenty of suitable reflective clothing options available: Vests, armbands, leg bands, stripes on your helmet, and blinker attached to your body and or bicycle.
- Make sure that your clothing or miscellaneous items do not obstruct your reflectors and lights
- Make sure that your bicycle is equipped with reflectors for riding at dawn, dusk or at night.
- Always ride slowly when riding at night.

### Assembly and Fit

It is essential that your bike is assembled and fitted correctly in order to ensure your safety, performance, and comfort. Even if you have the experience, skills, and tools to complete these essential steps before your first ride, HOVSCO recommends having a certified, reputable bike mechanic check your work.

**NOTICE:** In case you do not have the necessary experience, skill, or tools to complete assembly and fit, HOVSCO strongly recommends that you have a certified, reputable bike mechanic complete these procedures as well as any subsequent adjustments or tuning.

**NOTICE:** During the assembling process, it is critical to secure the front wheel and check the tightness of the axle nuts on the rear wheel. HOVSCO bikes have quick release front wheel mounting mechanisms and bolt-on rear wheels. These mechanisms can become loose or unsecured during shipping or over time. Inspect the torque and security of all wheel mounting hardware upon arrival and periodically thereafter. Both wheels need to be properly secured before operating your bike.

### Mandatory Equipment and Use Locations

Make sure you have all of the required and recommended safety equipment and follow all laws regarding the use of an electric bike in your area before riding. For example, these laws may specify the need for mandatory equipment, use of hand signals, and where you can ride.

### Replacing Components or Attaching Accessories

By using parts or components that are not original, you can jeopardize the safety of your bike, void your warranty, and in some cases, make your bike in violation of the law.



**You are solely responsible for the replacement of original components or the installation of third-party accessories not specifically recommended for your bike model by HOVSCO. It may void your warranty, create an unsafe riding condition, cause damage to property or your bike by HOVSCO, or result in serious injury or death if you use aftermarket accessories or components that have not been tested for safety and compatibility by HOVSCO.**

### Safety Check Before Each Ride

Check the condition of your bike before riding it, in addition to having regular maintenance performed on it. You should consult a certified, reputable bike mechanic if you are unsure how to conduct a comprehensive check before every ride.



### Electrical System (Applicable to HovAlpha, HovAlpha Step-Through and HovBeta Step-Through)

Your ebike's electrical system powers several components that control different operating conditions and user preferences. It is critical that you become familiar with all aspects of your ebike's electrical system and make sure it is working before each ride. The front and rear brake levers contain power cutoff switches that disable the hub motor's assistance when applied, and both should be checked for proper operation. Applying the throttle gradually should provide smooth acceleration. If your throttle, brake lever cutoff switches, pedal assistance, or lighting are malfunctioning, intermittently, or not working properly, please stop using your ebike and contact HOVSCO Support.

### Brakes

Ensure that the brakes and their system components are free from damage and are working properly. The front and rear brake levers should not touch the handlebar when fully squeezed. If you notice a problem with your bike's brakes, have them repaired by a certified, reputable bike mechanic.

### Tires and Wheels

If your wheels wobble side to side or up and down when you spin them, they must be repaired or replaced. If your wheels become untrue or your spokes loosen due to normal use, we recommend that you have a certified, reputable bike mechanic perform wheel tuning and truing operations on your bike. Unless you have adequate knowledge, tools, and experience, do not attempt to true wheels or tighten spokes. Ensure that the tires and inner tubes are in good working condition and have the proper air pressure. Always replace tires and inner tubes with punctures, cuts, or damage before riding. Incorrectly inflated tires can decrease performance, increase tire and component wear, and make riding your bike unsafe.

### Accessories, Straps, and Hardware

Make sure all hardware and approved accessories are properly attached according to instructions provided by the component manufacturer. It is a good idea to check overall hardware, straps, and accessories before each ride. If you discover anything amiss or something you're not sure about, have it checked by a certified, reputable bike mechanic.

### Handlebar, Grips, and Seat Adjustments

Make sure the handlebars and handlebar stem are aligned properly, fitted to the user, and torqued to their recommended values. Make sure the handlebar grips are not loose on the handlebar end. If your handlebar grips are loose, worn, or damaged, you should replace them before you ride. Before riding, the seat and seat post should be properly aligned, fitted to the user, and the seat post quick release should be properly tightened, closed, and secured.

### Battery Charged, Secured, and Unplugged

Make sure the battery is adequately charged and operating properly. Before you ride, ensure the battery charger is unplugged from the outlet, and the battery is stored in a safe place. The battery must be locked securely to the frame battery mount before you ride. If the battery is removed, don't operate the electrical system. Make sure you push hard enough when installing the battery into the frame, and hear the "CLICK" sound.

## CHARGER SAFETY INFORMATION

- You should only use the charger indoors, in a cool, dry, ventilated area, on a flat, stable, hard surface.
- Avoid contacting the charger with liquids, dirt, or metal objects. Do not cover the charger while it is in use.
- Place the charger in a safe place away from children.
- A fully charged battery can help extend the life of the battery and reduce the chance of over discharging.
- The battery should not be charged with any charger other than the one originally supplied by HOVSCO Bikes or a charger designed specifically for your bike, purchased directly from HOVSCO Bikes.
- This charger works on 110/240V 50/60 Hz standard home AC outlets and automatically detects and accounts for incoming voltage. It should not be opened or modified in any way.
- The cables should not be pulled or yanked. Carefully unplug both the AC and DC cables by pulling on the plastic plugs directly, and not on the cables themselves.
- The charger is expected to get relatively warmer as it is charged. If the charger becomes too hot to hold, if you smell a strange odor, or if you notice any other indicator of overheating, stop using the charger and contact HOVSCO Support.



**Charge the battery only with the charger originally supplied with the bike from HOVSCO Bikes, or a charger purchased directly from HOVSCO Bikes, designed for use with your specific bike serial number, as approved by HOVSCO Bikes. Never use an aftermarket charger, which can result in damage, serious injury, or death.**



**Please follow the instructions and safety information in this manual carefully when charging your bike from HOVSCO Bikes. A failure to follow proper charging procedures may cause damage to your bike, the charger, or personal property, or even result in serious injury or death.**

### General Operating Rules

**NOTICE:** Before you use your bike from HOVSCO, make sure you pay attention to all the general operating rules below.

- Be sure to obey the same road laws as all other road vehicles in your area.
- To learn more about traffic/vehicle laws in your area, contact the local road traffic authority.
- Ride predictably, in a straight line, and according to traffic flow. Never ride against traffic.
- Use the correct hand signals when turning.
- Ride defensively; you may be hard to see to other drivers.
- Concentrate on the road ahead. Avoid potholes, gravel, wet or oily roads, wet leaves, curbs, train tracks, speed bumps, drain gates, thorns, broken glass, and other obstacles, hazards, and puncture flat risks.
- Cross train tracks at 90-degree angles or walk your bike across.

- Expect the unexpected, such as opening car doors or backing out of driveways.
- Be careful at intersections and when passing other vehicles or cyclists.
- Get to know the features and operation of HOVSCO Ebikes. Practice and become proficient at shifting gears, applying the brakes, using the pedal assist system, and using the throttle in a controlled setting before riding in riskier conditions.
- Wear proper riding apparel and close-toed footwear. If you are wearing loose pants, use leg clips or elastic bands to prevent them from getting caught in the gears or chain. Do not use items that may restrict your hearing.
- Be sure to check your local rules and regulations before carrying cargo.
- When braking, use the rear brake first, then the front brake. When brakes are not applied correctly, they may lock up and lead to you losing control and/or falling.
- Keep a comfortable distance from other objects, riders, and vehicles. Safe braking distances are based on factors such as road surface and light conditions among other variable.

### Safety Notes

Listed below are safety notes to help you operate your HOVSCO bike safely. Please review them carefully. Failure to review these notes can lead to serious injury or death.

- Users must read and understand this manual before riding an HOVSCO Bikes bike. There may also be manuals for components on the bike, which should be read before installation or use using those components.
- Make sure you understand all instructions and safety warnings.
- Before you start riding, make sure the bike fits you properly. Too large or too small a bike may cause you to lose control or fall.
- Wear an approved bicycle helmet whenever you ride a bike and follow all instructions from the helmet manufacturer regarding fit and care of your helmet. Failure to wear a helmet when riding may result in serious injury or death.
- Check your bike's setup, tightening, and torque to recommended torque values before you use it, and regularly check the condition and tightness of components and hardware.
- In the area(s) in which you ride, it is your responsibility to familiarize yourself with the laws and requirements of operating this product.
- Ensure the handlebar grips are in good condition and properly installed. Loose or damaged grips can cause you to lose control and fall.
- This product must not be used with standard bike trailers, stands, vehicle racks, or accessories that HOVSCO has not tested for safety and compatibility and has not verified as safe or compatible.
- In addition to requiring special skills, off-road riding has a variety of conditions and hazards. Wear appropriate safety gear and do not ride alone in remote areas. Check local rules and regulations about whether off-road ebike riding is allowed.
- DO NOT ENGAGE IN EXTREME RIDING. This includes, but is not limited to, jumps, stunts, and any kind of riding that is beyond your capabilities. Although many articles/advertisements/catalogs depict extreme riding, this is not recommended nor permitted, and you can be seriously injured or killed if you perform extreme riding.

- There are limitations to the strength and integrity of bikes and bike parts, and extreme riding, such as but not limited to jumps, stunts, etc. can cause damage to bike components and/or cause or lead to dangerous riding situations, in which you may be seriously injured or killed.
- A failure to perform and verify proper installation of a component or accessory, its compatibility, its operation, or its maintenance can result in serious injury or death.
- You must consider your bike unsafe to ride until you consult a certified, reputable bike mechanic for a thorough inspection of all components, functions, and operations.
- You may void your warranty if you fail to charge, store, or use your battery correctly.
- Each time you ride, you should make sure the brake motor cutoff switches are working properly. The brake system is equipped with an inhibitor that cuts off power to the electric motor whenever the brakes are squeezed. Check proper operation of brake motor cutoff switches before riding.
- The pedal assistance sensor and throttle on this product should be used with extreme caution. Ensure you understand and are prepared for the pedal assistance to engage as soon as pedaling is underway.
- The user must understand how the throttle and pedal assistance work before using the bike and must travel at a speed appropriate for the usage area, riding conditions, and user experience level. Always use the lowest assist level until you are comfortable with the bike and feel confident in controlling the power.
- Any aftermarket changes to your bike from HOVSCO Bikes not expressly approved by HOVSCO Bikes could void the warranty and create an unsafe riding experience.
- The fact that electric bikes are heavier and faster than regular bikes requires extra caution and care while riding.
- When riding in wet conditions, you should slow down and increase braking distances. Feet or hands can slip in wet conditions and lead to serious injury or death.
- Do not remove reflectors.

### General Warnings

Bicycling, like any sport, carries risk of damage, injury, and death. As you choose to ride a bike, you assume that risk, so you need to know, and practice, the rules of safe and responsible riding as well as how to use and maintain the bike properly. The proper use and maintenance of your bike reduces the risk of damage, injury, and death. Do not combine biking with controlled substances. Never operate a bike while under the influence of alcohol, drugs, or any substance that could impair motor functions, judgment, or your ability to handle a bike or other vehicle safely.

HovBeta Step-Through is designed for use by persons aged 18 and older. In order to ride safely, riders must have the physical condition, reaction time, and metal capability to manage traffic, road conditions, and sudden situations, as well as respect the laws governing the use of electric bikes in the location they ride, no matter how old they are. Consult your physician before riding any bicycle if you suffer from an impairment or disability such as a visual impairment, hearing impairment, physical impairment, cognitive impairment, or seizure disorder.

### A Note for Parents and Guardians

You are responsible for the activities and safety of your child as a parent or guardian. Children under the age of 18 should not use HovBeta Step-Through. If you are transporting a child in a child safety seat, they should also be wearing a properly fitted and approved helmet.

**WARNING!** HOVSCO is not responsible for accidents, injuries, or product failures caused by unauthorized modifications or tampering with any part of the original specification.

**SAVE THESE INSTRUCTIONS**

**SPECIFICATIONS**

Model Name	HOVSCO HovBeta Step-Through
Max.load Capacity	450 lbs / 204kg
Max.Speed	Up to 20 MPH on Throttle. Can be adjusted to up to 26 MPH on Pedal Assist
Motor	1032W (Peak) 750W (Sustained) Brushless Hub
Battery	48V 720Wh
Battery Light	120PCS LED lamp beads, 4-meter range, 20 m <sup>2</sup> area
Range Average Per Charge	40-60 Miles
Wheel Size	20*4"
Tire Pressure	MAX to 20 PSI
Lights	Front/Rear
Charger	Max DC 54.6V 3.0A
Charging Time	Approx. 4 Hours
Water Resistance	IPX4
Weight	66.4 lbs (30kg)

\* Range Per Charge is measured under the conditions that power is sufficient, with a 75kg load, at 86°F(30°C), 70% humidity, on a level road, in pure electric riding mode. The results may vary depending on the temperature, load, wind speed, road conditions, and other factors.

**INSTALLATION INSTRUCTION**

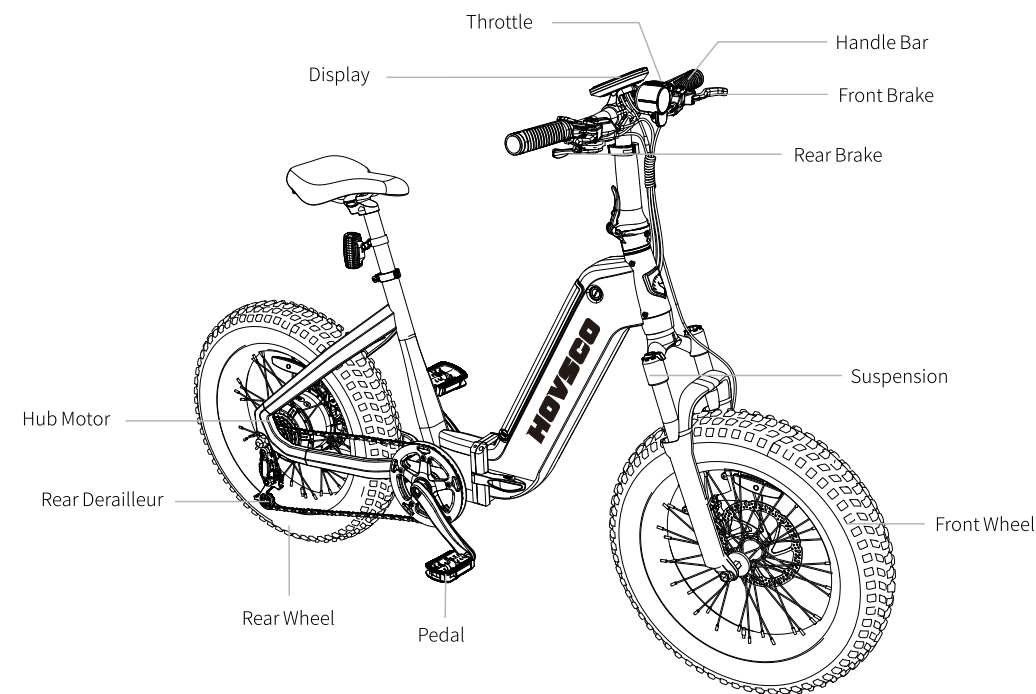

**WHAT'S IN THE BOX**

- 1\* Charger
- 1\* Charger cable
- 1\* Screwdriver
- 4\* Hex keys 3/4/5/6mm
- 3\* Wrenches 8-10 13-15 14-17
- 1\* Owner's manual
- 1\* Left pedal
- 1\* Right pedal
- 1\* Rear Derailleur Guard Rack Protector
- 1\* Front Hub Quick Release

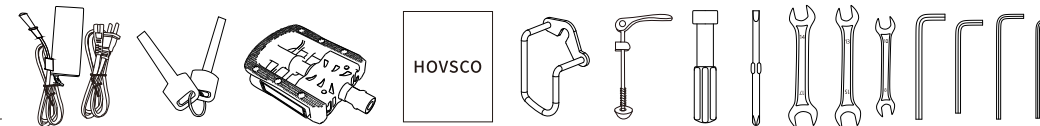

## ASSEMBLY

**Note:** The following steps are only intended to assist you in assembling your ebike; they are not intended to be a complete or comprehensive guide to assembly, maintenance, and repair. If you need assistance with assembly, repair, and maintenance of your ebike, contact a reputable, certified bike mechanic.

### Step 1. Unpack the bike

Open the box, take the front wheel out. Remove the HovBeta from the bike box with another person's assistance who is capable of lifting a heavy object safely. Remove the packaging material protecting the bike frame and components. Please recycle packaging materials especially cardboard and foam whenever possible.

Take out the kickstand, a small box of charger, and the big box of tools.

### Step 2. Remove the entire package foam and ribbon. (Be gentle if you use scissors)

### Step 3. Install the kickstand

Attach the kickstand on the frame with a 4mm hex key, and tighten it with recommended torque(5-7N.m). Then put it down to hold the bike up.

**Notes:** Keep the motor cable above the part of the kickstand attached onto the frame.

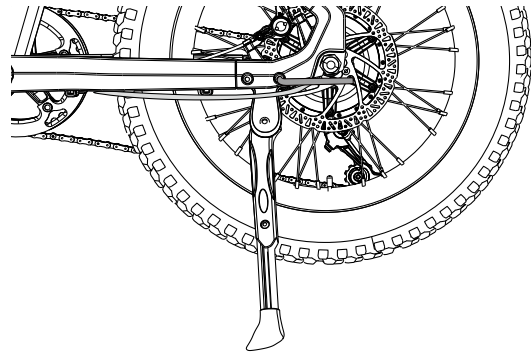

### Step 4. Pull the stem upright

Pull the stem upright and fold the latch up to close it.

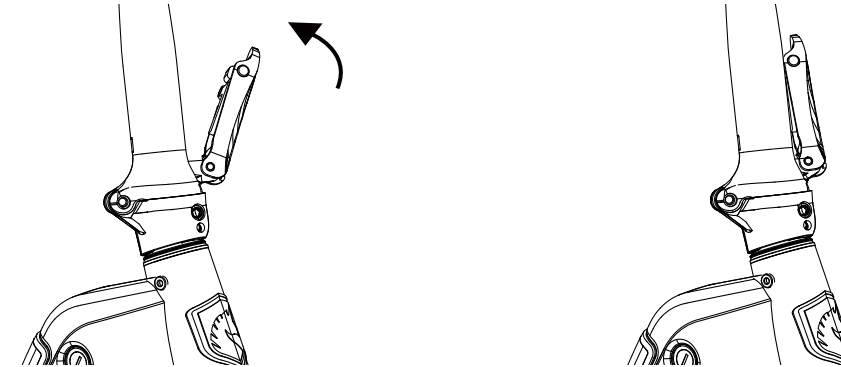
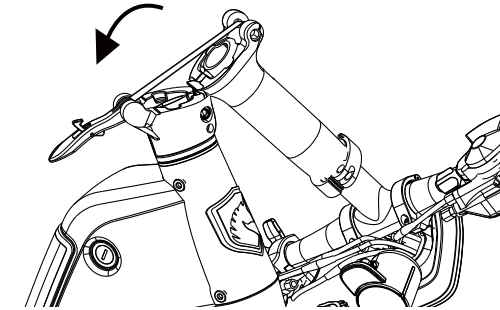

### Step 5. Install the handlebar

Insert the handlebar to the stem, and push it down to adjust height to your preference, then close the clamp to secure the handlebar in place.

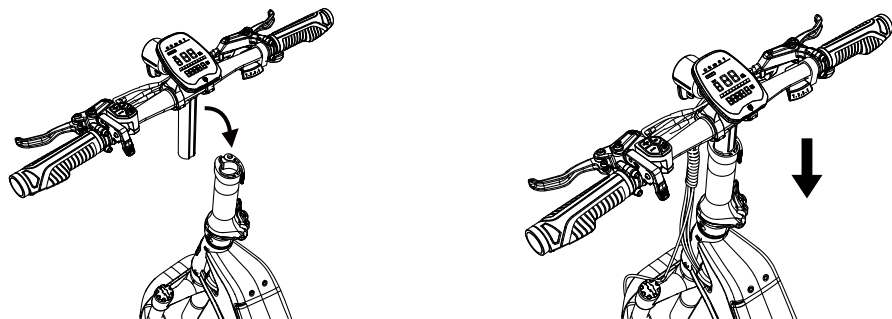

### Step 6: Adjust the stem

Loose the two stem bolts with 5mm hex key, and turn the stem facing forward, then tighten the two bolts until they can't go any further.

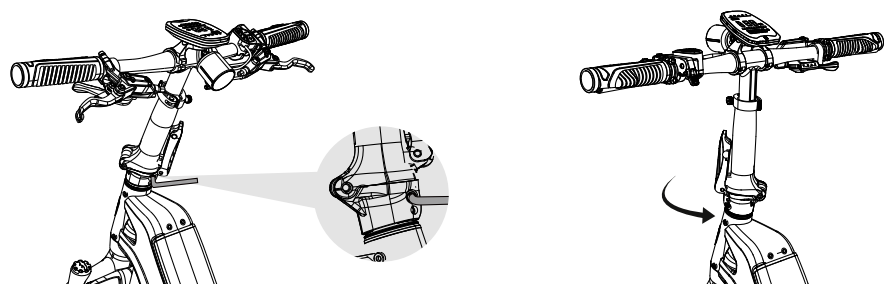

### Step 7. Adjust the display

Loosen display screws with a 3mm hex key. Then install display onto handlebar using the 3mm hex key and tighten screws.

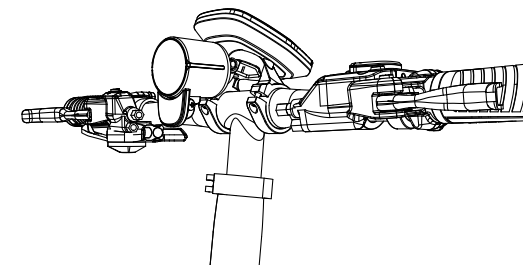

### Step 8: Install the front wheel

A. Remove the plastic protector from the front wheel hub. Take out the front fork protector from the front fork.  
(Please note: Front wheel and fork protectors are used to prevent the front wheel and forks from being deformed during transport. They belong to the packing material. You can just throw away this accessory!)

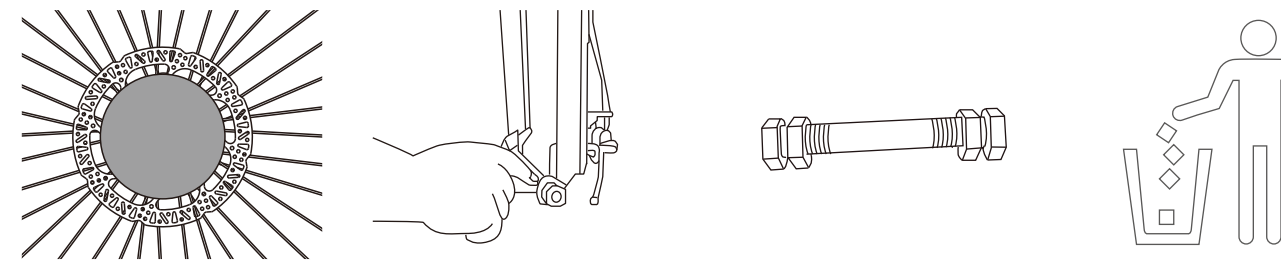

B. Insert the quick release into the front wheel, and tighten the screw a little bit. (**Quick release nut needs to be at the same end as the brake**)

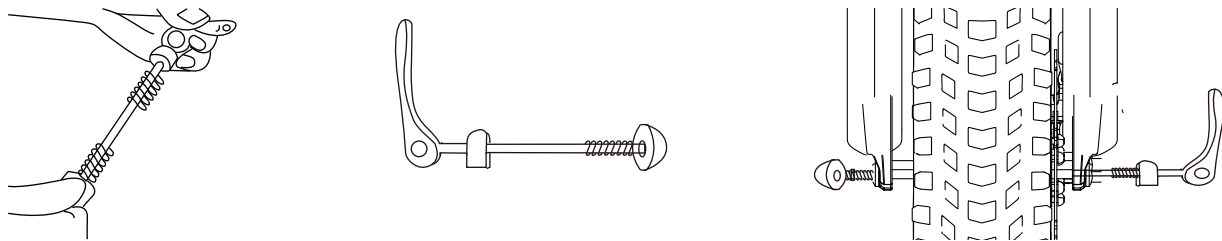

C. Install the front wheel on the fork. Make sure the fork is attached to the axle and make sure the disc is placed in the middle of the brake.

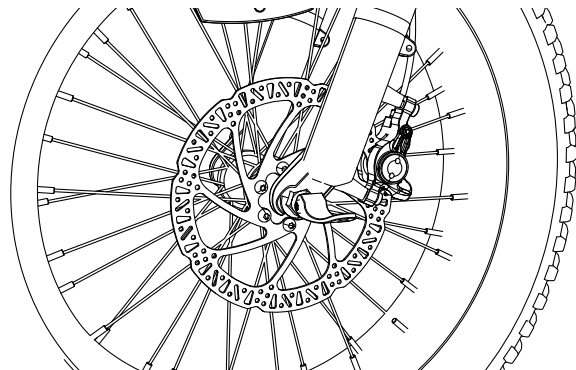

D. Tighten the screw with recommended torque 7-11 N.m and then hinge the quick release lever close fully.



**WARNING:** An improperly secured front wheel and/or handlebar stem can cause loss of control, accidents, serious injury, or death. Before each ride, make sure the front wheel and handlebar stem are securely attached to the bike.

**CAUTION:** Avoid touching the brake rotor, especially while the wheel or bike is in motion, or you could suffer serious injury. Hand oil can cause brake squeaking and reduce brake efficiency.



### Step 9: Install the pedals

Install the pedals with a pedal wrench. Locate the pedal with a smooth pedal axle interior and an "R" stamped into its end (1, below), indicating that it is the right pedal. The right pedal goes on the crank on the right side of the bike (which has the drive chain gears and corresponds to the right side of the rider's leg when riding)

**As the right pedal (1) is threaded, it is tightened by rotating it clockwise.** Grease the thread and carefully thread the right pedal onto the crank on the right side of the bike slowly and by hand. Make sure you do not cross thread or damage the threads.

**Left pedal (2) is reverse-threaded and tightens counterclockwise.** Make sure the remaining pedal has notches on the exterior of the axle and an "L" stamped into the end of the axle. Apply grease and attach the pedal slowly to the left crank. Do not cross thread or damage the threads.

Torque each pedal to 40-55 N.m.

Identifying marks Right pedal (has a "R" sticker) tightens clockwise. Left pedal (has a "L" sticker) tightens counterclockwise.

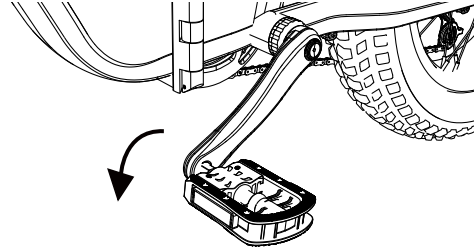
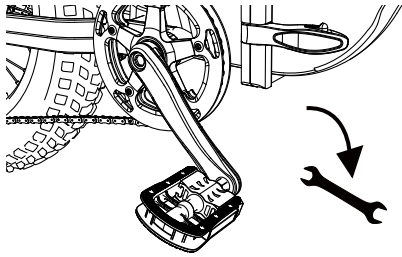
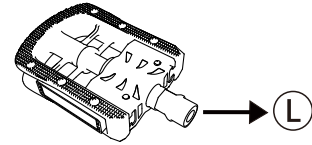
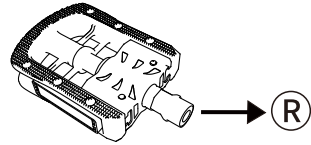

### Step 10: Install the derailleur guard

We completely recommend going to an ebike shop and asking an ebike expert to install the derailleur guard for you. The recommended torque is 5-7 N.m.

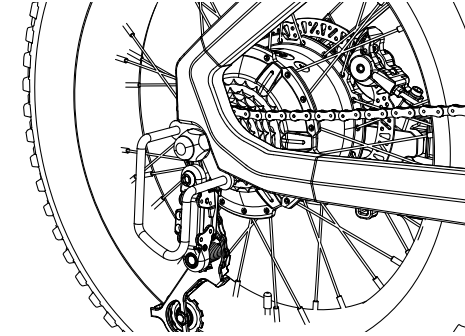
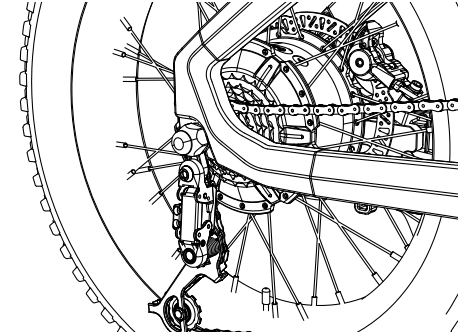

**WARNING:** Any small mistake can cause serious damage to your motor. An improperly secured motor can cause loss of control, accidents, serious injury, or death.

**Step 11. Set the desired seat height**

Hinge the quick release lever open fully. Adjust the seatpost to a comfortable height, while ensuring the seatpost is inserted past the top of the frame minimum insertion point.

Using the thumb nut, tighten the clamp so that there is some resistance when the lever is in line with the clamp bolt, but do not overtighten. Ensure the seat-post cannot move by closing the quick release lever.

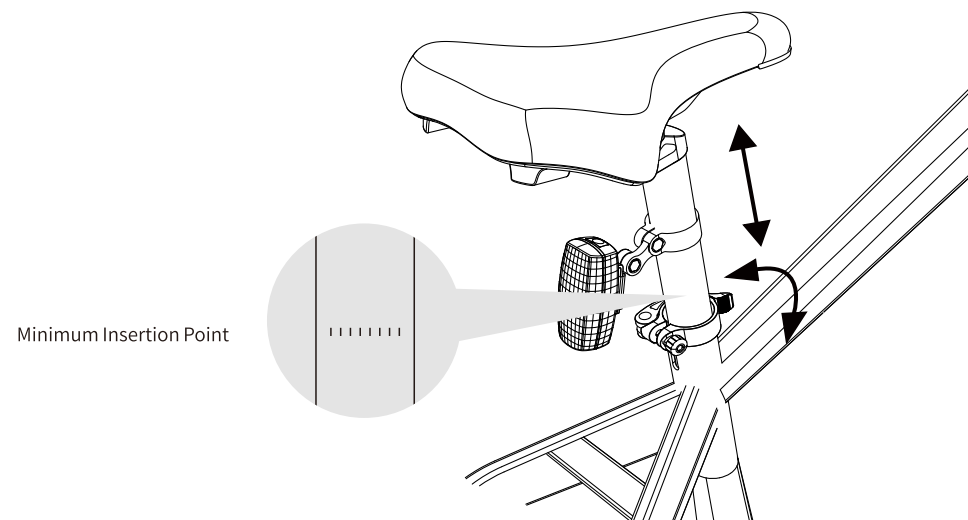

**Step 12: Adjusting the seat position and angle**

To change the angle and horizontal position of the seat:

A. Loosen the seat adjustment bolt on the clamp located under the rear wheel directly underneath the seat using a 6mm Allen key. Do not remove the bolt completely.

B. Move the seat backward or forward and tilt to adjust the angle. A horizontal position is ideal for most riders. You should not exceed the limits marked on the seat rail, which indicate the minimum and maximum horizontal movement allowed.

Holding the seat in the desired position, tighten the seat angle adjustment bolt securely.

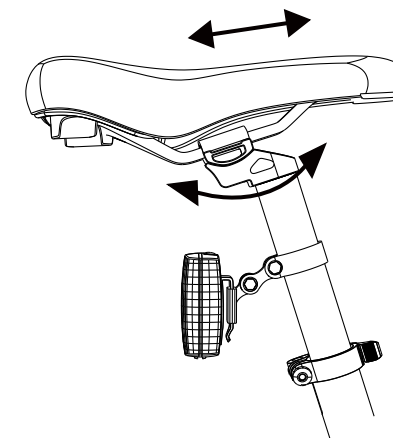



### Step 13: Check Battery and display

Hold down the power button circled in the picture to turn on the bike and the battery, 1 LED lights on the battery will light on. Red light means the battery energy level is 0%-10%. Green light means the battery energy level is 90%-100%.

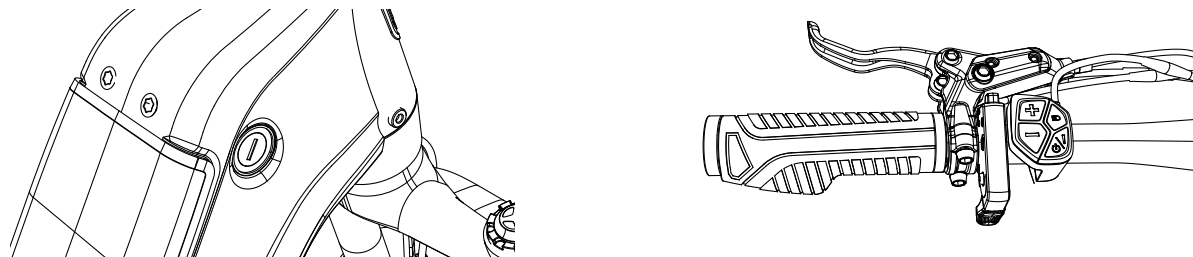

### Step 14: Inflate the tires

Ensure that the tires and tire beads are evenly seated on the rims. Set the tire pressure to MAX 20 PSI with a pump equipped with a A/V valve and a pressure gauge. DO NOT over inflate or under inflate tires.

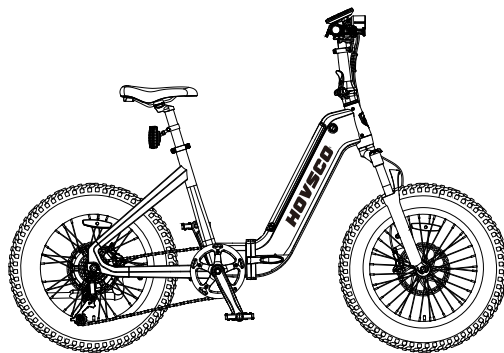

### FOLD YOUR BIKE

HovBeta ebikes can be folded for easy storage or transportation. Follow the steps below to fold your ebike.

1. Hold the crank arm vertically and fold the pedal by pushing it towards the bike and folding it up or down.



2. Open the seat post clamp, lower the seat, and close the seat post clamp.

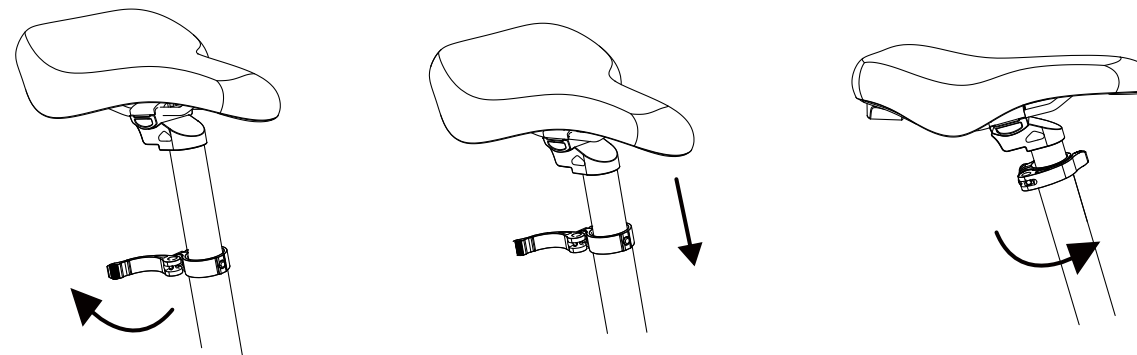

3. Pull the latch down away from the stem, then slide to the right side (see below illustrations), and fold the stem down.

**Note:** Push the button upward at the same time as pulling the latch.

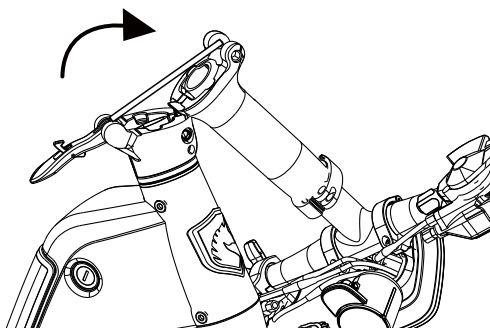

4. Holding the latch lock up, use your other hand to open the latch by pushing the button open and pulling it away from the frame, folding the rear wheel/section towards the other wheel and use the stand under the frame as needed.

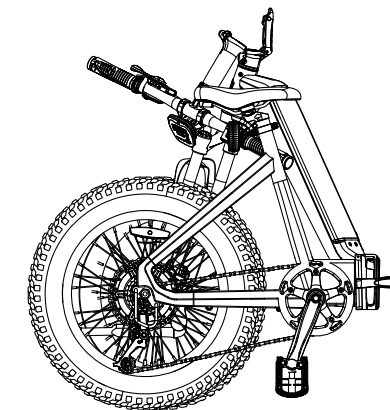
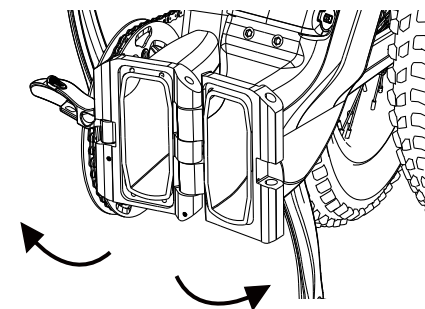
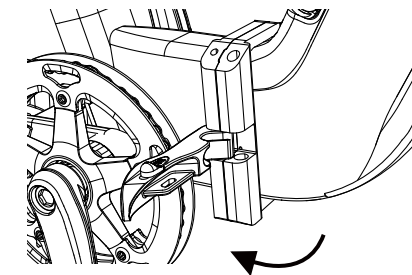
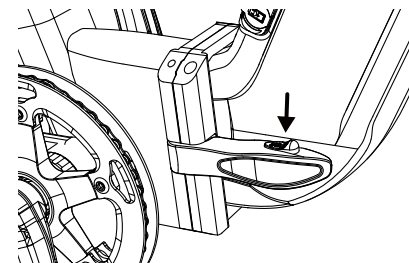

## Fork Replacement

### Fork Removal

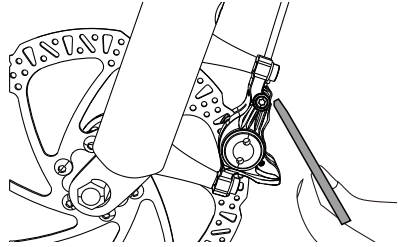

#### 1. Disassemble the disc brake clamp

Loosen the screws of the disc brake clamp at the outside hook; pull down the clamp.

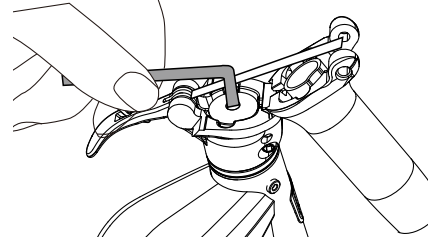

#### 2. Disassemble the clamping device of the vertical pipe

Pull the latch down away from the stem, then slide to the right side (see above illustrations), and fold the stem down.

Loosen the screws of the clamping device at the upper part of the vertical pipe; remove the clamping device.

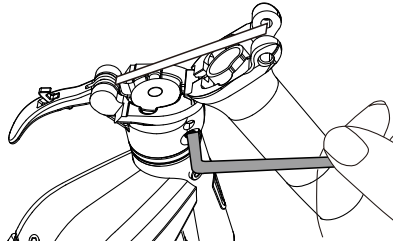

#### 3. Disassemble the vertical pipe

Loosen the screws at the two sides of the vertical pipe to make the vertical pipe free from the standpipe.

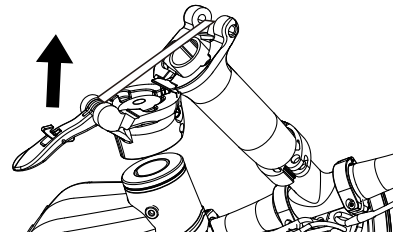

#### 4. Disassemble the small casing

Take out the handlebar, the small casing, and other small parts.

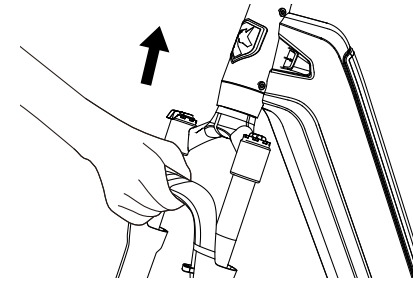

#### 5. Disassemble the grip, the gear lever and the wire-control handle

Take out the upper grip of the handlebar, the gear lever, and the wire-control handle in order.

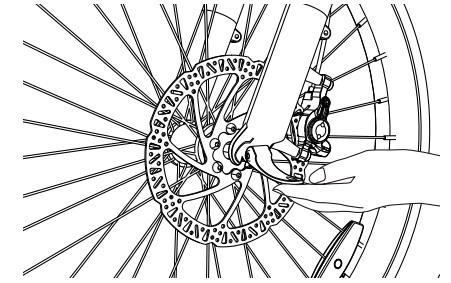

#### 6. Remove the frame

Remove the frame; separate the front fork from the head tube.

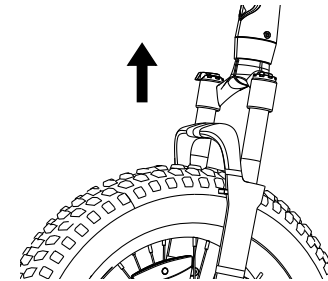

#### 7. Remove the front fork and the cartwheel

Loosen the side quick release of the cartwheel; remove the old front fork.

## Fork Installation

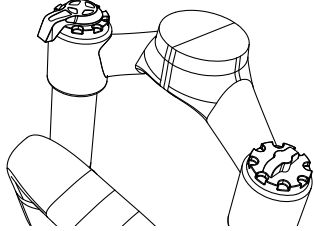

### 1. Squeeze the head part holder and the sunflower

Squeeze the head part holder and the sunflower into the vertical pipe of the front fork. (Just one easy turning on the right knob makes your suspension fork go rigid; And easily adjust the preload by quick turning the left knob.)

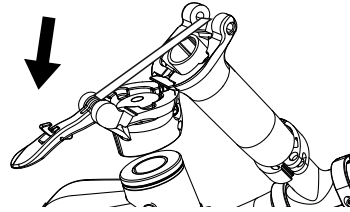

### 2. Assemble the head frame the small casing

Assemble the frame and the small casing in order.

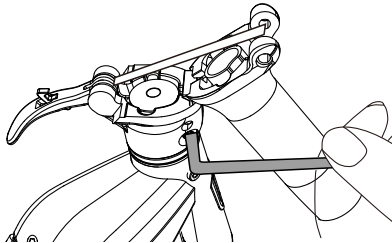

### 3. Lock up the vertical pipe

Moderately tighten the screws of the two sides of the vertical pipe.

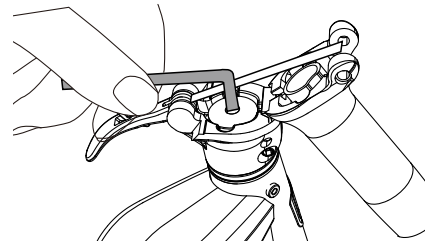

### 4. Lock up the clamping device

Put in the clamping device, tighten the screws to fix the vertical pipe. and lock up the screws at the two sides of the vertical pipe. Pull the stem upright and fold the latch up to close it.

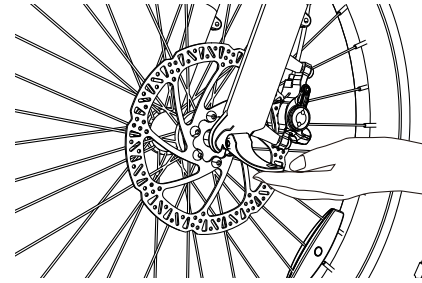

### 5. Assemble the wire-control handle, the gear lever and the grip

Assemble the wire-control handle, the gear lever and the grip on the handlebar in order; fix with screws.

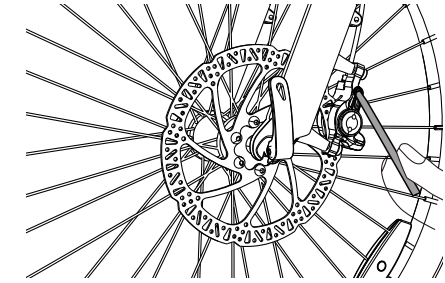

### 6. Assemble the cartwheel

Assemble the cartwheel that has been broken off on the front fork, place the left and right legs on an even keel, revolve the quick release and fix and lock up the cartwheel and the front fork.

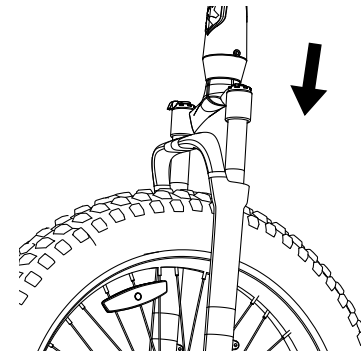

### 7. Lock up the disc brake clamp

Lock and fit the disc brake clamp that has been broken off on the front fork disc brake seat, make the clamp groove parallel to the disc, and trim the function of the clamp that has been fitted.



**Notes:** The fork can be adjusted according to your weight. You can easily adjust the suspension performance to be soft or hard by quick turning on the knob.

## Maintenance Of Brakes

1. Disc brakes are easily affected by oil, please do not use any lubricants on or near disc brake discs, pads and calipers.
2. The running-in of the disc and the pads requires 20 to 40 braking times. After the running-in is complete, the braking force will be significantly enhanced.
3. When the thickness of the pads is less than 3mm or worn to the edge of the warning groove of the caliper, replace it at once.
4. When the pads are newly installed, the mouth of the caliper should be wiped clean.

**Notes:** If you want to change your brake pads or add brake fluid, please go to a nearby bicycle store and let an experienced mechanic help you.

## How to take out battery?

After folding the bike, insert the key into battery, turn the key and battery can be taken out.

## Battery Charging

### Charging Procedure

Here are the steps to charging your bike from HOVSCO Bikes:

1. **Make sure the battery is off.**
2. **Remove the rubber cover from the charging port.**
3. **Plug the charger into the battery's charging port, BEFORE PLUGGING CHARGER INTO POWER OUTLET.** Whether the battery is on or off the bike, place the charger on a flat, stable surface, and connect the DC output plug from the charger (round barrel connector) to the charging port on the side of the battery.
4. **Plug the charger into an electrical outlet.** Connect the charger input plug (110/240-volt plug) to the power outlet. During charging, the LED charge status light on the charger will illuminate solid red, indicating that charging has begun.
5. **Disconnect the charger from the outlet, then the charging port.** When the charger has fully charged, indicated by one charging indicator light turning solid green, unplug the charger from the wall outlet first, then remove the charger output plug from the battery charging port.
6. **Battery indicator light: Red: 0%-10%. Green: 90%-100%.**

Charge your battery at temperatures between 32 °F - 86 °F (0 °C - 30 °C) and ensure the battery and charger are not damaged before charging. Please contact HOVSCO Bikes Product Support for assistance if you notice anything unusual while charging.

## Battery Charging Information

- Before each charge, check the charger, charger cables, and battery for damage.
- Ensure that you charge it in a place where it is clear and safe from potential damage or tripping hazards. Always charge indoors in a cool and dry place away from direct sunlight, dirt, or debris. Always charge your battery in temperatures between 32 °F - 86 °F (0 °C - 30 °C) .
- The battery can be charged on or off the bike. Turn the key to the unlocked position, and remove the battery.
- You should recharge the battery after every use so that it is ready to go for the next ride. There is no memory effect, so charging the battery after short rides will not damage it.
- Charging the battery normally takes 4 hours.
- The charge indicator light will turn red during charging. After charging is complete, the light will turn green. Make sure the light is facing upward when charging.
- After the green light indicates a complete charge, remove the charger from the battery within one hour. It is designed to automatically stop charging the battery after it has been fully charged, but unnecessary wear of the charging components may occur if the charger is left connected to the battery and a power source for more than 12 hours.
- You should never charge a battery for more than 12 hours at a time.
- DO NOT leave a charging battery unattended.
- For turning on the bike: Hold the button circled for around 2 seconds next to the display to turn on the bike.
- For turning off the bike: Hold the button circled for around 2 seconds next to the display to turn off the bike.

## REMOVING THE BATTERY

- Turn the key to the unlocked position.
- Remove the battery from the tray.
- DO NOT touch or damage the “+” and “-” terminal contacts on the top of the battery and keep them clear of debris.

## WHEN INSTALLING THE BATTERY ONTO THE BIKE

- DO NOT force the battery into the tray; slowly align and gently push the battery down into the tray. Ascertain that there is no gap between the battery and the tray, and that the battery is fully secured on the tray.
- Turn the key to the locked position.
- Make sure the battery is properly secured to the bike before each use by pulling outward on the battery with both hands after it has been locked.

### LONG-TERM BATTERY STORAGE

- Follow the instructions below to maintain the health and longevity of your battery when you store your bike from HOVSCO Bikes for more than two weeks at a time. Charge (or discharge) the battery to approximately 75%.
- Do not leave the battery attached to the frame. Remove it from the bike during long-term storage.
- Store the battery between 32 - 86 °F (0 - 30 °C) in a dry, climate-controlled location indoors. Every month, check the battery and if necessary, charge it to 75% with the HOVSCO Bike Charger.

 Please follow the above instructions for storing your bike and battery from HOVSCO Bikes. Failure to follow proper battery storage procedures can result in a non-functional battery. A replacement will not be covered under warranty.

 Please discontinue use and charging if the battery is damaged, non-functional, performing abnormally, or has been dropped or involved in a crash, with or without obvious signs of damage.

 DO NOT cover up the charger while it is charging. The charger air cools and needs to be on a hard, flat surface in an open space. Use the charger with the indicator light facing upward. DO NOT use it when the charger is inverted, which can inhibit cooling and reduce charger lifespan.

 You should not open the battery housing as doing so will void the warranty and can cause serious injury or death to you or others.

### HovBeta QUICK START GUIDE

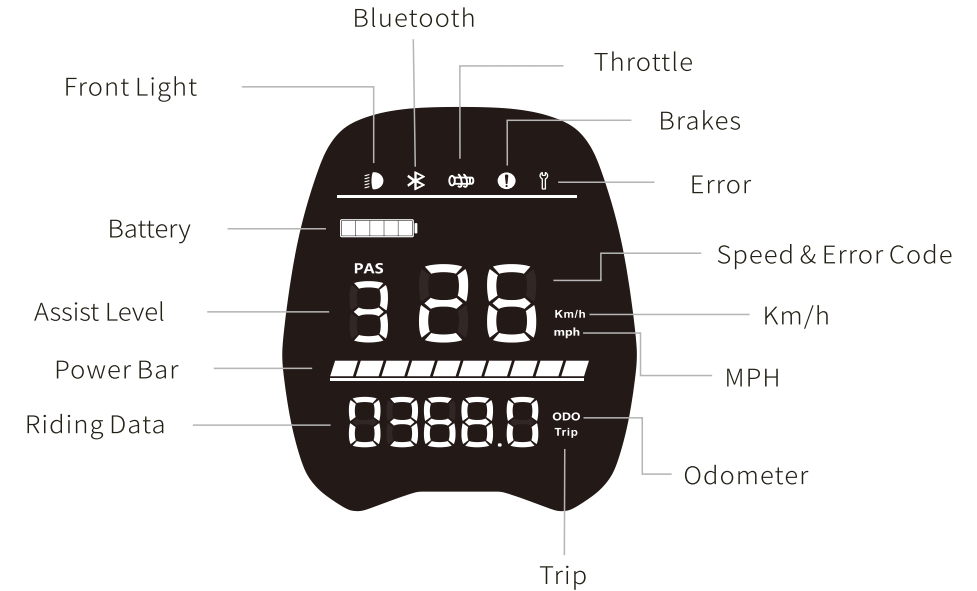

## GETTING STARTED

When power on your ebike, it's on PAS 0, you can shift it between PAS1 to PAS5 by pressing the "+" or "-". The throttle and pedal assist will only work when the ebike is at PAS1 ~PAS5. All of Hovsco ebikes have four working modes. 1,throttle only mode; you can ride the with pure electric assist; 2, pedal assist mode, you can easily pedal the ebike and get the power assist from the motor, use the display & button to adjust the assist level from 0-5 to meet your needs; 3, normal bike mode, Set the assist level to 0 and pedal like a normal bike; 4, walking mode, Press and hold the minus button for three seconds to enter " walking mode", the ebike will travel at 4.83-6.44 km/h (3-4 MPH) without pushing by man power, making it easy to be moved on challenging terrains (e.g. narrow trails and very steep hills).

Our HovBeta as a Class 2 ebike with the max speed as 20mph, but it requires you to finish the register on our app at your first use by scanning the QR code on the display or user manual, or the speed will be limited up to 6.21mph. Besides, you can also use our app to adjust the pedal assist speed up to 28mph.

## BATTERY AND CHARGING

For best results, charge the battery off the bike indoors in a moderately warm environment. Plug the charger into the charging port and then connect the charger to a wall outlet to charge the battery. While charging, the LED indicator light will be solid red. When charging is complete, the LED indicator light will turn solid green.

## MAINTENANCE AND SERVICE

Your HovBeta Step-Through Ebike will operate smoothly and last longer if you maintain it properly. Watch the "HOW TO ASSEMBLE" video we prepared for you before you assemble your bike. If you have questions during the assembly process, please contact HOVSCO at (+1)909-990-8695 or contact link <https://www.hovsco.com/pages/contact>

## SAFETY

Wear an approved bicycle helmet whenever you ride a bicycle, regardless of whether it is required by law. When riding the HovBeta Step-Through Ebike, you should adhere to all local laws.

## OPERATION INSTRUCTION

**NOTICE:** Please do not perform any steps in the Operation section of this manual until you have thoroughly read this manual, as the following sections contain important safety information.



The first time you operate the bike, read and understand every section of this manual. The manual contains important safety information that must be followed to avoid dangerous situations, accidents, property damage, injury, or even death.



Users must follow the instructions and warnings contained in this manual for safety. Please do not attempt to operate your bike from HOVSCO Bikes until you have adequate knowledge and understanding of its control and operation. Failure to follow instructions can result in serious injury or death and is not covered by warranty. Contact HOVSCO if you have any questions about assembly or operation.



Before operating, users must become accustomed to the bike's power control system. The pedal assistance feature is also a powerful feature, and users should fully research and understand how to use it before using it for the first time. The failure to familiarize yourself with and practice the operation of the power system on your HOVSCO Bikes bike can result in damage, injury, or death.

## RIDING RANGE

HOVSCO Bikes' range is how far the bike can travel on a single charge of the onboard battery. In this manual, range values are based on expected usage characteristics of HOVSCO Bikes' bicycles. Range is affected by many factors, including elevation, speed, payload, acceleration, number of starts and stops, ambient air temperature, tire pressure, and terrain.

When you first get a bike from HOVSCO Bikes, we suggest that you select the lowest level of assistance in order to familiarize yourself with your bike and travel route. After you become familiar with the range requirements of your travel routes and the capabilities of your bike, you can then adjust your riding characteristics. The following table provides general range estimates based on a variety of factors. This table is meant to help owners to understand the factors that can contribute to decreased range, but HOVSCO Bikes makes no claims to the range that individual users might experience in a particular use case.

Expected Range	Operating Condition(s)
64km (40 mi)	Hilly Terrain/Heavy Payload/Windy/Throttle Mode
80km (50 mi)	Flat Terrain/Normal Payload/Not Windy/High Pedal Assist
96km (60 mi)	Flat Terrain/Normal Payload/Not Windy/Low Pedal Assist



### Parking, Storage, and Transport

To ensure your bike is well cared for on and off the road, please follow these tips for parking, storing, and transporting it.

- When pushing or carrying the bike manually, turn off the power to avoid accidental acceleration.
- Turn the power and any lights off to conserve battery.
- Ensure the battery is locked to the frame in the off position or use the key to remove the battery and store it in a temperature-controlled location for safety.
- Park indoors when possible. You should park your ebike in a dry location as soon as possible if you have to park outdoors in rain or wet conditions. An ebike used in wet conditions requires more frequent maintenance to prevent rust, corrosion, and to make sure all systems are functioning properly.
- HOVSCO Bikes must be parked in public places in accordance with local regulations and rules.
- It is recommended that you lock up your bike to ensure that it is secure and reduce the likelihood of theft. We do not make any claims or recommendations about the proper lock hardware or procedures for securing your bike, but we do recommend you take appropriate precautions to prevent theft of your bike.
- HOVSCO Bikes cannot be parked, stored, or transported on a vehicle rack that is not designed for the bike's weight and size.
- Rack your bicycle on a vehicle that is compatible with the width of your tires. Some racks may not accommodate all wire widths.
- When carrying your bike on a vehicle rack for transportation, unlock and remove the battery. This will reduce the weight of the bike, make lifting and loading easier, and allow you to transport the battery in the cab of the vehicle.
- Do not transport HOVSCO Bikes on a vehicle rack during rain, as this can cause water damage to the electrical components.

## USER MAINTENANCE AND SERVICE INSTRUCTIONS

### Basic Bike Care

HOVSCO Bikes recommends that if you lack the skills, experience, or tools to perform maintenance and adjustments on your bike, you have a certified, reputable bike mechanic perform these tasks.

### Recommended Service Intervals

To ensure HOVSCO Bikes function as intended, and to reduce wear and tear on their systems, regular inspections and maintenance are vital. Below are the recommended service intervals. Real world wear and tear, and the need for service, will vary with conditions of use. Inspections, service, and necessary replacements are generally recommended at the interval indicated in the table below.

Interval	Inspect	Service	Replace
Weekly, 160-321 km (100-200 mi)	<ul style="list-style-type: none"> <li>- Check hardware for proper torque.</li> <li>- Check the drivetrain for proper alignment and function (including the chain, freewheel, chainring, and derailleur).</li> <li>- Check wheel trueness and for quiet wheel operation (without spoke noise).</li> <li>- Check if the brakes are functional.</li> <li>- Check the condition of the frame for any damage.</li> </ul>	<ul style="list-style-type: none"> <li>- Clean the frame by wiping the frame down with a damp cloth.</li> <li>- Use barrel adjuster(s) to tension derailleur/brake cables if needed.</li> <li>- Adjust the hydraulic brake cable</li> </ul>	<ul style="list-style-type: none"> <li>- Replace any components found to be damaged beyond repair or broken by HOVSCO Bikes Product Support or a certified, reputable bike mechanic.</li> </ul>
Monthly, 402-1207 km (250-750 mi)	<ul style="list-style-type: none"> <li>- Check brake pad alignment, brake cable tension .</li> <li>- Check the bike is shifting properly, proper derailleur cable tension.</li> <li>- Check chain stretch.</li> <li>- Check brake and shifter cables for corrosion or fraying.</li> <li>- Check spoke tension.</li> <li>- Check accessory mounting (rack mounting bolts, fender hardware, and alignment).</li> </ul>	<ul style="list-style-type: none"> <li>- Clean and lubricate the drivetrain.</li> <li>- Check crankset and pedal torque.</li> <li>- Clean brake and shift cables.</li> <li>- True and tension wheels if any loose spokes are discovered.</li> </ul>	<ul style="list-style-type: none"> <li>- Replace brake and shift cables if necessary.</li> <li>- Replace brake pads if necessary.</li> </ul>
Every 6 Months, 1207-2011 km (750-1250 mi)	<ul style="list-style-type: none"> <li>- Inspect drivetrain (chain, chainring, freewheel, and derailleur).</li> <li>- Inspect all cables and housings .</li> </ul>	<ul style="list-style-type: none"> <li>- Standard tune-up by a certified, reputable bike mechanic is recommended.</li> <li>- Grease bottom bracket.</li> </ul>	<ul style="list-style-type: none"> <li>- Replace brake pads.</li> <li>- Replace tires if necessary.</li> <li>- Replace cables and housings if necessary.</li> </ul>

### Pre-Ride Safety Checklist

**Notice:** Before every ride, and after every 25-45 miles (40-72 km), we advise following the pre-ride safety checklist.



Safety Check	Basic Steps
1. Brakes	<p>Ensure front and rear brakes work properly.</p> <p>Inspect brake pads for wear and make sure they are not overworn.</p> <p>Position the brake pads correctly in relation to the rims.</p> <p>Make sure brake cables are lubricated, adjusted correctly, and do not show obvious wear.</p> <p>Ensure brake levers are lubricated and tightly secured to the handlebar.</p> <p>Test that the brake levers are firm and that the brake motor cut off functions and the brake light are functioning properly.</p>
2. Wheels and Tires	<p>Ensure tires are inflated within the recommended limits posted on the tire sidewalls and hold air.</p> <p>Make sure tires are in good condition, have no bulges or excessive wear, and are not damaged in any other way.</p> <p>Verify the rims are true and have no obvious wobbles, dents, or kinks.</p> <p>Ensure all wheel spokes are tight and not broken.</p> <p>Check axle nuts and front wheel quick release to ensure they are tight. Make sure the locking lever on the quick release skewer is properly tensioned, closed, and secured.</p>
3. Steering	<p>Ensure that the handlebars and stem are properly adjusted, tightened, and allowed to steer.</p> <p>Test the stem clamp bolt security by twisting the handlebars (see assembly step 6).</p> <p>Ensure the handlebar is set correctly in relation to the fork and the direction of travel.</p>
4. Chain	<p>Ensure the chain is clean, oiled, and runs smoothly.</p> <p>Extra care is required in wet, salty/otherwise corrosive, or dusty conditions.</p>
5. Bearings	<p>Ensure all bearings are lubricated, run freely, and display no excess movement, grinding, or rattling.</p> <p>Check headset, wheel bearings, pedal bearings, and bottom bracket bearings.</p>
6. Cranks and Pedals	<p>Ensure pedals are securely tightened to the cranks.</p> <p>Ensure the cranks are securely tightened and are not bent.</p>
7. Derailleur and Brake Cables	<p>Check that the derailleur is adjusted and functioning properly.</p> <p>Ensure shifter and brake levers are attached to the handlebar securely.</p> <p>Ensure all shifter cables are properly lubricated.</p>
8. Frame, Fork, and Seat	<p>Check that the frame and fork are not bent or broken.</p> <p>If either frame or fork are bent or broken, they are secured and undamaged.</p> <p>Check that the seat is adjusted properly, and the seatpost quick release lever is securely tightened.</p>

9. Motor Drive Assembly and Throttle	<p>Ensure the hub motor is spinning smoothly and the motor bearings are in good working order.</p> <p>Ensure that all power cables running to the hub motor are securely attached and undamaged.</p> <p>Ensure the hub motor axle bolts are secure and that the torque arm, torque arm bolt, and torque washers are in place.</p>
10. Battery	<p>Ensure the battery is charged before use.</p> <p>Ensure there is no damage to the battery.</p> <p>Lock battery to frame and ensure that it is secured.</p> <p>Charge and store bike and battery in a dry location, between 32 °F - 86°F (0°C-30°C).</p> <p>Let the bike dry completely before using it again.</p>
11. Electrical Cables	<p>Make sure that connectors are fully seated and free of debris or moisture.</p> <p>Check cables and cable housing for obvious signs of damage.</p> <p>Make sure the headlights, taillights, and brake lights are working, adjusted properly, and not obstructed.</p>
12. Accessories	<p>Ensure all reflectors are properly fitted and not obscured.</p> <p>Ensure all other fittings on the bike are secured and functional.</p> <p>Inspect the helmet and other safety gear for signs of damage.</p> <p>Make sure the rider is wearing a helmet and other required safety gear.</p> <p>Ensure mounting hardware is properly secured if equipped with a front rack, rear rack, basket, etc.</p> <p>When fitted with a rear rack, ensure the tail light and power wire are properly secured.</p> <p>Ensure the fender mounting hardware is properly secured if fitted with fenders.</p> <p>Ensure there are no cracks or holes in fenders.</p> <p>If installed, ensure the optional rear wheel lock is secured in the unlocked position and the key is removed before every ride.</p>



Within the first 50-100miles (80-160km) of use, your cables, spokes, and chain will stretch, and the bolted connection will loosen. Always have a certified, reputable bike mechanic perform a tune-up on your HovBeta Step-Through after your initial break-in period of 50-100mi (80-160km) (depending on riding conditions such as total weight, riding characteristics, and terrain). The regular inspections and tune-ups of your bike are particularly important to ensure that it remains safe and fun to ride.

## Tire Information

HovBeta Step-Through uses 20" x 4" rubber tires with inner tubes. Tires are designed for durability and safety for regular cycling activities. The inflation and condition of the tires should be checked before each use. Proper inflation, care, and timely replacement will help to maintain your bike's operating characteristics, and prevent unsafe conditions.

On HovBeta Step-Through, HOVSCO Bikes recommends MAX TO 20 PSI for the stock tires. Always stay within the manufacturer's recommended air pressure range as listed on the tire sidewall.



It is critically important that proper air pressure is always maintained in pneumatic tires. Never underinflate or over inflate the tires. Low pressure may result in loss of control, while overinflated tires may explode. Failure to always maintain the air pressure rating indicated on pneumatic tires may result in tire and/or wheel failure.



Use a pressure gauge to inflate your tires from a regulated air source. Unregulated air sources could overinflate your tires, resulting in a burst tire. Even tires equipped with built-in flat-preventative tire liners, like those that come with bikes by HOVSCO Bikes, can and do get flats from punctures, pinches, impact, and other causes. In the event of tire wear or a flat tire, you must replace the tires and/or tubes before operating your bike or you risk injury to riders and/or damage to your bike.



Make sure that all air pressure has been removed from the inner tube before removing the tire from the rim when changing a tire or tube. Failure to remove all air pressure from the inner tube could result in serious injury.



The use of aftermarket tires or inner tubes, not provided by HOVSCO Bikes, may void your warranty, create an unsafe riding condition, or damage your bike. Replace aftermarket tires with sufficient reflective sidewall striping, if required by law.

For more information on tire or tube replacement procedures, or question about tire inflation, contact HOVSCO Bikes Product Support.

Support Link: <https://www.hovsco.com/pages/contact> or Call: (+1)909-990-8695

## Derailleur

Right next to the brake lever, on the right side of the handlebar, are two levers with 7-1 gears. Those are derailleur levers. You can change your riding experience by pressing those levers to make the chain move to different gears.

## TROUBLESHOOTING

	Symptoms	Possible Causes	Most Common Solutions
1	The bike does not work	<ol style="list-style-type: none"> <li>1. Insufficient battery power</li> <li>2. Faulty connections</li> <li>3. Battery not fully seated in tray</li> <li>4. Improper turn on sequence</li> <li>5. Brakes are applied</li> </ol>	<ol style="list-style-type: none"> <li>1. Charge the battery</li> <li>2. Clean and repair connectors</li> <li>3. Install battery correctly</li> <li>4. Turn on bike with proper sequence</li> <li>5. Disengage brakes</li> </ol>
2	Irregular acceleration and/or reduced top speed	<ol style="list-style-type: none"> <li>1. Insufficient battery power</li> <li>2. Loose or damaged throttle</li> <li>3. Misaligned or damaged magnet ring</li> </ol>	<ol style="list-style-type: none"> <li>1. Charge or replace battery</li> <li>2. Replace throttle</li> <li>3. Align or replace magnet ring</li> </ol>
3	The motor does not respond when the bike is powered on	<ol style="list-style-type: none"> <li>1. Loose wiring</li> <li>2. Loose or damaged throttle</li> <li>3. Loose or damaged motor plug wire</li> <li>4. Damaged motor</li> </ol>	<ol style="list-style-type: none"> <li>1. Repair and or reconnect</li> <li>2. Tighten or replace</li> <li>3. Secure or replace</li> <li>4. Repair or replace</li> </ol>
4	Reduced range	<ol style="list-style-type: none"> <li>1. Low tire pressure</li> <li>2. Low or faulty battery</li> <li>3. Driving with too many hills, headwind, braking, and/or excessive load</li> <li>4. Battery discharged for a long period of time without regular charges, aged, damaged.</li> <li>5. Brakes rubbing</li> </ol>	<ol style="list-style-type: none"> <li>1. Adjust tire pressure</li> <li>2. Check connections or charge battery</li> <li>3. Assist with pedals or adjust route</li> <li>4. Contact Product Support if range decline persists.</li> <li>5. Adjust the brakes</li> </ol>
5	The battery will not charge	<ol style="list-style-type: none"> <li>1. Charger not well connected</li> <li>2. Charger damaged</li> <li>3. Battery damaged</li> <li>4. Wiring damaged</li> </ol>	<ol style="list-style-type: none"> <li>1. Adjust the connections</li> <li>2. Replace</li> <li>3. Replace</li> <li>4. Repair or replace</li> </ol>
6	Wheel or motor makes strange noises	<ol style="list-style-type: none"> <li>1. Loose or damaged wheel spokes or rim</li> <li>2. Loose or damaged motor wiring</li> </ol>	<ol style="list-style-type: none"> <li>1. Tighten, repair, or replace</li> <li>2. Reconnect or replace the motor.</li> </ol>

### Error Detection

An error detection system is integrated into the display and controller of your bike from HOVSCO. An error code will appear if the electronic control system fails. These error codes are the most common and can help in troubleshooting. It is recommended that you stop operating your bike immediately when it displays an error code and contact HOVSCO Bikes.

Error Code	Definition
E0	Throttle Fault
E1	Torque Sensor Fault
E2	Controller Meter Communication Fault
E3	Low Voltage Protection
E4	Controller High Temperature
E5	Motor Hall Fault
E6	Motor Stalling
E7	Controller Over Current Protection
E8	Motor High Temperature Protection
E9	Battery Over Voltage Protection

### Additional Information on Wear

As compared to bikes without power assistance, HovBeta Step-Through components are subject to higher wear. This is because HovBeta Step-Through can travel at higher speeds and has a greater weight than regular bicycles. Higher wear is not a defect in the product and is not covered by the warranty. Components commonly affected are tires, brake pads, rotors, spokes, wheels, and batteries.



When a component's useful life has expired, it can lose its function unexpectedly. This can cause serious injury or even death. Therefore, pay attention to characteristics such as cracks, scratches, and changes in the color or operation of components that could indicate their useful life has ended. Replace worn components immediately. An experienced, reputable bike mechanic should be consulted if you are unfamiliar with regular maintenance.

## LIMITED WARRANTY

Warranty and other binding legal terms (e.g., terms of purchase, etc.) for your bike are subject to change at any time. You can view your terms of purchase and current warranty at <https://www.hovsco.com/pages/warranty-policy>

### Warranty Info

All HOVSCO ebikes, and their individual covered components (as defined herein), are protected against all manufacturing defects in material or workmanship for two (2) years(core components) after the date of a qualifying purchase (the "Warranty Period"). This Limited Warranty is only applicable to United States ebike purchases and in accordance with the following terms:

The Limited Warranty is only valid for the original owner of an ebike purchased from HOVSCO online or in person. A Limited Warranty begins upon your receipt of the ebike and will terminate at the earliest of the end of the Warranty Period or the sale or transfer of the ebike to another person. Additional owners or transferees of the ebike will not be covered under this Limited Warranty.

The Limited Warranty covers the replacement of the following items but with different time span: motor, battery, torque sensor, charger, LCD screen, switch, front light, frame, front fork, handlebar, crank, throttle, pedal, flywheel, thumb shifter, rear derailleur, brake disc, tire (each a "covered component").

Please check the details at <https://www.hovsco.com/pages/warranty-policy>

During the Warranty Period, the Covered Components are warranted to be free from defects in materials and/or workmanship.

### This Limited Warranty Does Not Cover:

- The normal wear and tear of any Covered Component.
- Consumables or normal wear and tear parts (including without limitation tires, tubes, brake pads, cables and housing, grips, chain and spokes).
- Damage to Covered Components resulting from failure to follow instructions in the ebike owner's manual, acts of God, accident, misuse, negligence, abuse, commercial use, alterations, modifications, improper assembly, installation of parts or accessories not originally intended or compatible with the ebike as sold, operator error, water damage, extreme riding, stunt riding, or improper follow-up maintenance.
- Without a doubt, HOVSCO will not be liable or responsible for any damage, failure, or loss caused by any unauthorized service or use of unauthorized parts.
- The Battery is not warranted against damage caused by power surges, improper chargers, improper maintenance or other such misuse, normal wear or water damage.
- Hovsco does not offer an extended warranty. If you have purchased an. extended warranty. it must be honored by the store at which it was purchased.

Determining whether damage or defect to an ebike or covered component is protected by this limited warranty shall be in the sole discretion of HOVSCO.

### **Shipping Damage:**

Damage to a covered components during shipping is not covered by this Limited Warranty, but HOVSCO will replace such damaged covered components if you:

- Notify HOVSCO of a covered components damaged in the shipping process within fifteen (15) days of your receipt of the ebike;
- Provide HOVSCO with a dated picture of the damaged covered components;
- Take note of any immediately recognizable damage on the shipper' s Bill of Lading prior to signing off on the shipment.

Shipping damage claims are very time-sensitive, and you must inspect your ebike for damage as soon as you receive it.

If you choose to set up your own independent shipping method, such as use of a freight forwarder or other similar service, HOVSCO will not replace any Covered Components damaged during such shipping method.

### **Credit Card Chargebacks:**

If any ebike purchase becomes subject to a credit card charge back in any amount, and you are still in possession of the ebike, then this Limited Warranty shall be invalidated until the credit card charge back has been resolved.

### **Claims Process:**

HOVSCO will not replace covered components under this limited warranty without first seeing photos or video of the damaged components.

In order to exercise your right to receive a replacement for a Covered Component under this Limited Warranty, you must:

- Contact the HOVSCO Product Support team by visiting <https://www.hovsco.com/pages/contact> or by phone at (+1)909-990-8695.
- Initially, the Product Support team will identify simple solutions for the issue with your ebike.
- When the Product Support team determines that a Covered Component needs to be replaced, they will provide you with instructions on how to return the defective Covered Component and receive a replacement.
- After you receive the replacement Covered Component, the Product Support team will assist you in replacing or installing the new Covered Component into your electric bike.
- The shipping costs associated with returning a Covered Component will be your responsibility, unless HOVSCO agrees to pay them in writing. Replacement Covered Components under this Limited Warranty shall only be shipped to the address of the original purchaser.

The remedies described above are your sole and exclusive remedies and hovsco' s entire liability for any breach of this limited warranty. Hovsco' s liability shall under no circumstances exceed the actual amount paid by you for the ebike, nor shall hovsco under any circumstances be liable for any consequential, incidental, special or punitive damages or losses, whether direct or indirect.

Some states do not allow the exclusion or limitation of incidental or consequential damages, so the above limitation or exclusion may not apply to you.

This limited warranty gives you specific legal rights and you may also have other rights, which vary from state to state.

To the extent permissible under applicable law, hovsco disclaims all implied warranties, including without limitation the warranties of merchantability and fitness for a particular purpose for the duration of this express limited warranty.

Some states do not allow limitations on how long an implied warranty lasts, so the above limitation may not apply to you.

### **Link to Assembly Video and Online Resources**

Please visit the "Video" section of the HOVSCO Bikes website

(<https://www.hovsco.com/pages/video>) to view the official HovBeta Step-Through Assembly Video.

For more information on best practices, please visit the HOVSCO Bikes website ([www.hovsco.com](http://www.hovsco.com)).

### **We are here to help!**

If you have questions, please:

Access HOVSCO Bikes Help Center (<https://www.hovsco.com/pages/help-center>),

Contact us directly by visiting <https://www.hovsco.com/pages/contact>, or

Call HOVSCO Bikes Product Support: (+1)909-990-8695