

# Operator's Manual

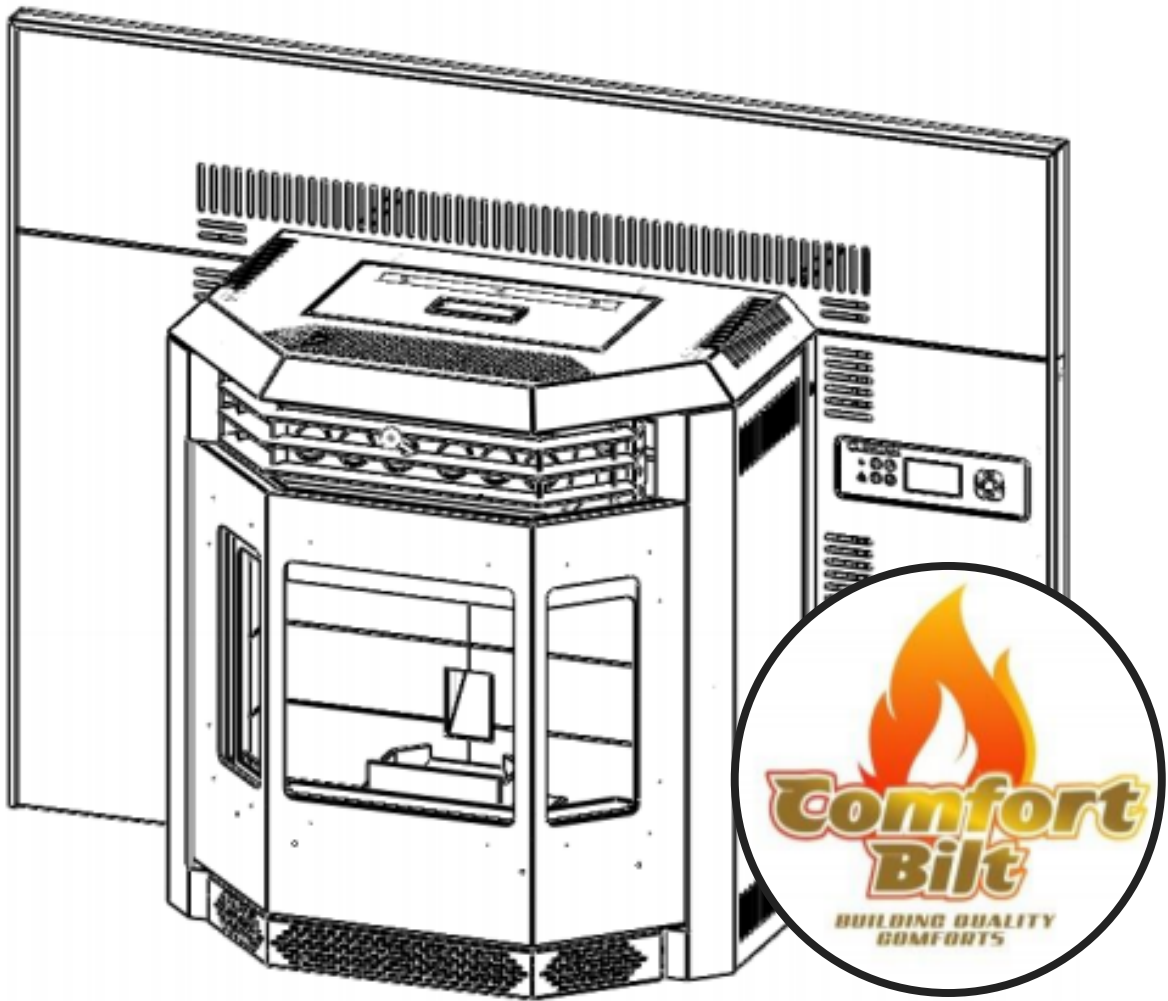

## HP22i Pellet Stove Insert

[WWW.COMFORTBILT.NET](http://WWW.COMFORTBILT.NET)

# TABLE OF CONTENTS

<b>Safety Precautions.....</b>	<b>3-6</b>
<b>Introduction and Pellets.....</b>	<b>7</b>
<b>Safety and Other Features.....</b>	<b>8</b>
<b>Specifications.....</b>	<b>9</b>
<b>Installation Overview.....</b>	<b>10</b>
<b>General Venting.....</b>	<b>11</b>
<b>Minimum Termination Clearances.....</b>	<b>12</b>
<b>Masonry Heater Installation.....</b>	<b>13</b>
<b>Factory Built (Metal) Heater Installation.....</b>	<b>14</b>
<b>Installation into Combustible Enclosure.....</b>	<b>15</b>
<b>Framing.....</b>	<b>15</b>
<b>Minimum Enclosure Clearances.....</b>	<b>16</b>
<b>Minimum Clearance to Combustibles.....</b>	<b>16</b>
<b>Minimum Mantel Clearances.....</b>	<b>17</b>
<b>Insert Finishing (Shroud).....</b>	<b>18</b>
<b>Pre-Operation.....</b>	<b>19</b>
<b>Operation.....</b>	<b>20</b>
<b>Controller Panel/Software.....</b>	<b>21-26</b>
<b>Maintenance.....</b>	<b>27-29</b>
<b>Warranty Information.....</b>	<b>30</b>



## WARNING



Please read this entire manual before installation or use of this pellet fuel-burning room heater. Failure to follow these instructions may result in property damage, bodily injury, or even death.

- Do not store or use gasoline or other flammable vapors and liquids in the vicinity of this or any other appliance
- Do not overheat - If any external component starts to glow, the stove is overheating. Reduce the feed rate as over-firing will void the warranty
- Comply with all minimum clearances to combustibles as specified. Failure to comply may cause a house fire.

## CAUTION

Check building codes prior to installation. Contact the regulating authority prior to installation to determine the need for a permit.

- Installation must comply with local, regional, state, and national codes and regulations.
- Consult local building or fire officials about restrictions or inspection requirements in your area.



## WARNING



**HOT!** Do not touch. Severe burns and/or the ignition of clothing may occur. Glass and other surfaces are hot during operation and cool down.

- Keep children away
- Carefully supervise children in same room as appliance.
- Do not operate without protective barriers in place.
- Keep clothing, furniture, draperies, and other flammable materials away.



## CAUTION DO NOT DISCARD!

- Important operating and maintenance instructions included.
- Read, understand, and follow these instructions for safe installation and operation.
- This manual is to be left with the party responsible for use and operation.

## WARNINGS AND SAFETY PRECAUTIONS

Please read this section carefully.

Operate the stove according to the safety instructions and recommendations outlined here and inserted throughout the text. Anyone who uses this stove must read the instructions and be familiar with the controls

### OWNER'S RESPONSIBILITY

Proper assembly, safety, and use of the stove is the owner's responsibility.

- Read and follow all safety instructions.
- Carefully follow all assembly instructions.
- Maintain the stove according to the directions and schedule provided within this operator's manual.
- Ensure that anyone who operates the stove is familiar with all controls and safety precautions.

***This wood heater needs periodic inspection and repair for proper operation. It is against federal regulations to operate this wood heater in a manner inconsistent with operating instructions in this manual.***

### SPECIAL MESSAGES

This Manual contains special messages to bring attention to potential safety and product damaging concerns, as well as helpful operating and servicing information. Please read all of the information carefully to avoid potential injury and stove damage.

***NOTE: General information is given throughout the manual that may aid in the operation or service of the stove.***

## IMPORTANT SAFETY PRECAUTIONS



This symbol points out important safety instructions which, if not followed, could endanger your personal safety. Read and follow all instructions in this manual before attempting to operate this equipment.



### DANGER

Indicates a serious injury or fatality **WILL** result if the safety instructions that follow this signal word are not obeyed.



### WARNING

Indicates a serious injury or fatality **COULD** result if the safety instructions that follow this signal word are not obeyed.

### CAUTION

Indicates minor or moderate injury to you or your property **COULD** result if the safety instructions that follow this signal word are not obeyed.

### IMPORTANT

Indicates helpful information for proper assembly, operation, or maintenance of your equipment.



You must read, understand, and comply with all safety and operating instructions in this manual before attempting to setup and operate your stove. Failure to comply with all safety and operating instructions can result in serious personal injury to you and/or bystanders, and/or property damage.



## WARNING

- Read this entire manual before you install and use your new pellet stove. Failure to follow instructions may result in property damage, bodily injury, or even death.
- Children and adults should be alerted to the hazards of high surface temperatures and should avoid contact to skin and/or clothing.
- Young children should be carefully supervised when they are in the same room as the stove
- Clothing and other flammable materials should not be placed on or near this unit
- Flammable or explosive liquids such as gasoline, naphtha, alcohol, or engine oil must **NEVER** be used in or around stove. These liquids must be stored in a separate room as the open flame in the fire box could ignite the fumes of such liquids.



## WARNING

Proper installation of this stove is necessary for safe and efficient operation. Installing this product improperly may result in a **house fire** and/or **personal injury**.

All applicable building codes for your location must be followed. In areas where building codes require additional steps to the installation of this product not included in this manual, the building codes will take precedence and must be followed. Contact your local building inspector to obtain any necessary permits or inspection guidelines before installing the product.

## CAUTION

Burning wood pellets according to recommendations will assure longer stove life and less fuel related problems. The use of grates or other methods of supporting the fuel in this stove is prohibited and will void all warranties.



## WARNING

- DO NOT Burn garbage in this unit. The burning of other solid fuels such as cord wood or wood chips in this stove is not permitted. Any fuels not certified which are burned in this stove will void the warranty
- DO NOT Route power cord in high traffic areas. *A power surge protector plugged into a grounded 120 volt power source is required.*
- DO NOT Install a flue damper in the exhaust venting system of this unit.
- DO NOT Connect this unit to a chimney flue servicing another appliance
- DO NOT Install in a sleeping room.
- DO NOT Connect to any air distribution duct or system.
- DO NOT Connect directly to a masonry chimney
- DO NOT Terminate vent in any enclosed or semi-enclosed area, such as; carports, garage, attic, crawl space, under a sun deck or porch, narrow walkway or closed area, or any location that can build up a concentration of fumes such as a stairwell, covered breezeway etc
- **NEVER** touch door latches or heat tube scraper while stove is in operation; they get extremely hot.



## WARNING

If the electrical power fails at any time when the stove is hot, keep all stove doors closed. The automatic safety features must not be bypassed.

## CAUTION

Tested and approved for pellet fuel. Burning any other type of fuel voids warranty.

## CAUTION

All applicable building codes for your location must be followed. In areas where building codes require additional steps to the installation of this product that are not included in this manual, the building codes will take precedence and must be followed. Contact your local building inspector to obtain any necessary permits or inspection guidelines before installing the product.

- Contact local building or fire officials about restrictions and installation inspection requirements in your area
- Contact your local authority (such as municipal building department, fire department, fire prevention bureau, etc.) to determine the need for a permit
- This pellet stove is designed to burn pellet fuel only
- A working smoke detector is required and must be installed in the same room as the stove.
- This stove is not intended for use in commercial applications
- Door and ash pan must be closed and latched during operation
- Notify your insurance company of pellet stove installation
- This installation must conform with local codes. In the absence of local codes you must comply with EN 14785.
- The structural integrity of the manufactured home floor, wall, and ceiling/roof must be maintained.
- Keep combustible materials (such as grass, leaves, etc.) at least three feet away from the flue outlet on the outside of the building.
- This stove should not be used as the only source of heat in the house. Power outages and periodic maintenance will result in a total loss of heat.
- Do not leave hopper door open while unattended.

## CAUTION

- Installation and repair of this pellet stove should be done by a qualified service person. The appliance should be inspected before use and at least once per year by a qualified service person. It is imperative that the control compartments, fire box, and circulating air passageways of the stove are kept clean.
- The operation of exhaust fans such as bathroom fans, attic fans, etc... might starve the pellet stove of combustible air, creating a negative pressure in the room. Provide adequate ventilation of the room the stove is installed in, otherwise the pressure switch may shut off operation of the pellet stove.
- The moving parts of this stove are propelled by high torque electric motors. These parts can cause severe damage to body parts that get near them. Keep all body parts away from auger and fans while the stove is plugged into an electrical outlet. Moving parts are subject to begin moving while power is supplied.
- The venting surfaces can become hot enough to cause burns if touched. Non combustible shielding or guards may be required.
- Install all venting at the clearances specified by the vent manufacturer. All venting joints, whether vertical or horizontal, should be made gas-tight with recommended sealants specified by vent manufacturer.
- According to HUD (Housing & Urban Development) requirements, when installing within a mobile home, this stove must be grounded directly to the steel chassis of the mobile home, and bolted to the floor. Direct air access must be provided by way of a fresh air intake kit.
- For use in the United States and Canada.
- Approved for installation in mobile homes.
- Producer of this appliance reserves the right to alter its products, specifications, and/or price without notice.

## INTRODUCTION

Congratulations on your investment in quality. We have worked hard to ensure that this pellet stove meets the highest standards for usability and durability. With proper care, your stove will provide many years of dependable service. Please read entire manual before installation and use.

Complies with the ASTM E1509, (UM) 84-HUD, ULC/ORD-C-1482.

U.S. Environmental Protection Agency Certified to comply with 2020 particulate emission standards using pellet fuel.

## BURNING PELLET FUEL

Ashes need to be removed from the stove periodically. See Normal Care & Maintenance section for cleaning procedures.

Due to the nature of pellet fuels, this stove will require attention periodically. Regular cleaning is an important part of burning pellet fuel.

### Do Not Burn:

1. Garbage
2. Lawn clippings or yard waste.
3. Materials containing rubber, including tires.
4. Materials containing plastic.
5. Waste petroleum products, paints or paint thinners, or asphalt products.
6. Materials containing asbestos.
7. Construction or demolition debris.
8. Railroad ties, or pressure-treated wood.
9. Manure or animal remains
10. Paper products, cardboard, plywood, or particleboard. The prohibition against using these materials does not prohibit the use of fire starters made from paper, cardboard, saw dust, wax and similar substances for the purpose of starting a fire in an affected wood heater.

Burning these materials may result in the release of toxic fumes or render the heater ineffective and cause smoke.

## PELLETS

- This pellet stove is designed and approved to burn wood pellets, that comply with pellet fuels industry standards. Minimum of 40 lbs. density per cubic foot, 1/4" to 5/16" in diameter, with a maximum length of 1" to 1/2", and less than 1% ash.
- The performance of your pellet stove is greatly affected by the type and quality of the wood pellets you use. As the heat output of various quality wood pellets differ, so too will the performance and heat output of the pellet stove.
- Wood pellets are generally produced out of wood waste such as sawdust and shavings. The raw material is dried, mechanically fractioned to size and extruded into pellets under high pressure. Wood pellets need to be protected from direct exposure to moisture. Water, from sources such as condensation and humidity, causes pellets to expand and break down into unusable fuel. Keep fuel dry.
- It is important to select and use only pellets that are dry and free from dirt and debris. Dirty fuel will adversely affect the operation and performance of the unit, and will void the warranty. The Pellet Fuel Institute (PFI) has established standards for wood pellet manufacturers. Only use pellets that meet or exceed PFI standards for premium fuels.

Pellet fuel quality can greatly fluctuate. The unit was tested with premium grade pellets. You cannot use a lesser grade, but higher grades can be used.

## CLINKERS

Impurities, such as silica (clinkers), will need to be regularly cleaned and removed from the pellet stove. Clinkers will form a hard mass and block airflow through the pot liner. High quality fuels will usually result in fewer clinkers.

## UNDERSTANDING YOUR STOVE

Your stove utilizes a vertical auger fuel feed system that is operated by a microprocessor controlled digital circuit board. The digital circuit board allows the vertical auger fuel system to run in a timer based, non-continuous cycle. This cycling allows the auger to run for a predetermined amount of time. The auger pushes pellets up a chute located in the hopper. The pellets will then turn and fall through another chute into the burn pot. Your stove is equipped with an automatic ignition system that should ignite the fuel within 3-5 minutes of pressing the On/Off button. As pellets fill the burn pot and ignite, outside air is drawn across the fuel and heated during the combustion process with is then pulled across the heat exchange tubes by the exhaust motor. As the stove reaches operating temperature, the room air is then circulated around the heat exchange tubes by a room air blower, distributing warm air into the room. The amount of heat that is produced by the stove is proportional to the rate of fuel that is burned. Because a forced draft pressure is required for the combustion process inside the stove, it is extremely important that the exhaust system be properly installed and maintained. Also, the doors must remain closed while in operation and the seals on the doors must be properly maintained.

## OTHER STOVE FEATURES

**Exchange Tube Scraper:** Scrapes the carbon buildup that can accumulate on the heat-transfer tubes. **Never touch while stove is Hot.**

*See Figure 1a*

**Glass Air Wash System:** Allows the stove to draw in air, through the lined up slots, to gently wash against the interior of the glass to help keep it free of soot buildup. To the right is open, to the left is closed. *See Figure 1b*

## AUTOMATIC SAFETY FEATURES

### POWER OUTAGE

During a power outage, the stove will shut down safely. Do not open the main door or ash pan door. During a power failure, the exhaust fan will not run. Keeping the doors sealed will allow the exhaust vent to draft out naturally. When the power is restored, the stove will not restart. If the exhaust temperature is still 120 degrees Fahrenheit when power is restored, the exhaust and convection fans will continue to run until the stove cools. See lighting instructions to restart stove.

**Install at least one smoke detector on each floor of your home to ensure your safety. They should be located away from the stove, and close to the sleeping areas.**

**You should have separate CO monitors for areas near the stove**

### OVERHEATING

**Over Fire Protection:** If the stove is being over fired or burning too hot, the high limit switches will automatically shut down the stove to avoid damage to other components. If the temperature on the hopper reaches 200 degrees Fahrenheit, the auger will automatically stop and the stove will shut down. The exhaust fan will continue to run until the proof of fire switch cools. Allow the stove to cool before attempting to re-ignite. See Start-Up.

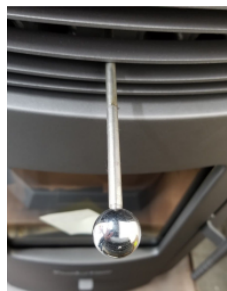

Figure 1a: Scraper



Figure 1b: Glass Airwash



## SPECIFICATIONS

Model Number	HP22i
BTU/Hour Output (1)	12,987 - 41,810
Heating Capacity (2)	Up to 2,800 sq. ft.
Particulate Emissions	1.542 g/hr
Efficiency (HHV)	75.8%
Power Consumption	520 Watts ignition
Power Consumption	150 Watts operation
Fuel Storage Capacity	47 lbs
Exhaust Size	3" (metric fitting)
*Width	19.5"
*Height	24.5"
*Depth	12"
Weight	231 lbs.
Shroud Width	43"
Shroud Height	32"
Room Blower CFM	142 CFM

*\*Measurements are of insert-able fire box*

(1) Heat output will vary depending on the brand, type and quality of fuel, and the moisture content.

Consult your dealer for best results.

(2) Based on post 1982 home construction, requiring 35 BTU/Hr. per Sq. Ft.

- Emissions will vary, depending on the feed level, burning time, and fuel. Consult your dealer for best results.
- Measurements above are of the insertable fire box.

## GLASS SPECIFICATIONS

This stove is equipped with 3 panes of ceramic glass. Replace glass only with Qualified ceramic glass.



## WARNING

This stove has a manufacturer set minimum low burn rate that must not be altered. It is against federal regulations to alter this setting or otherwise operate this stove in a manner inconsistent with the operating instructions within this manual. If the unit is modified, it will no longer be compliant with the EPA regulations.



## WARNING

If you see black smoke at the end of the exhaust/chimney, these are not normal emissions.

1. Check for clinkers or blockages in the burn pot.
2. Check for leakages around the stove, such as glass door or ash pan.
3. Check for potential blockages in the exhaust channels.
4. Check that the exhaust voltages are correctly set.

## UNPACKING

- Your stove will come fully assembled, other than the controller panel and shroud.
- **Connect the data line to the controller from below.**
- Remove all packing material and tape from the inside of the firebox.
- Remove any tape on the outside of the glass.
- Open hopper, and remove all packing material and power cord.

*Note: Make sure the hopper is free of all foreign matter before filling with fuel. Foreign material will cause auger jams and will void stove warranty.*

# INSTALLATION OVERVIEW

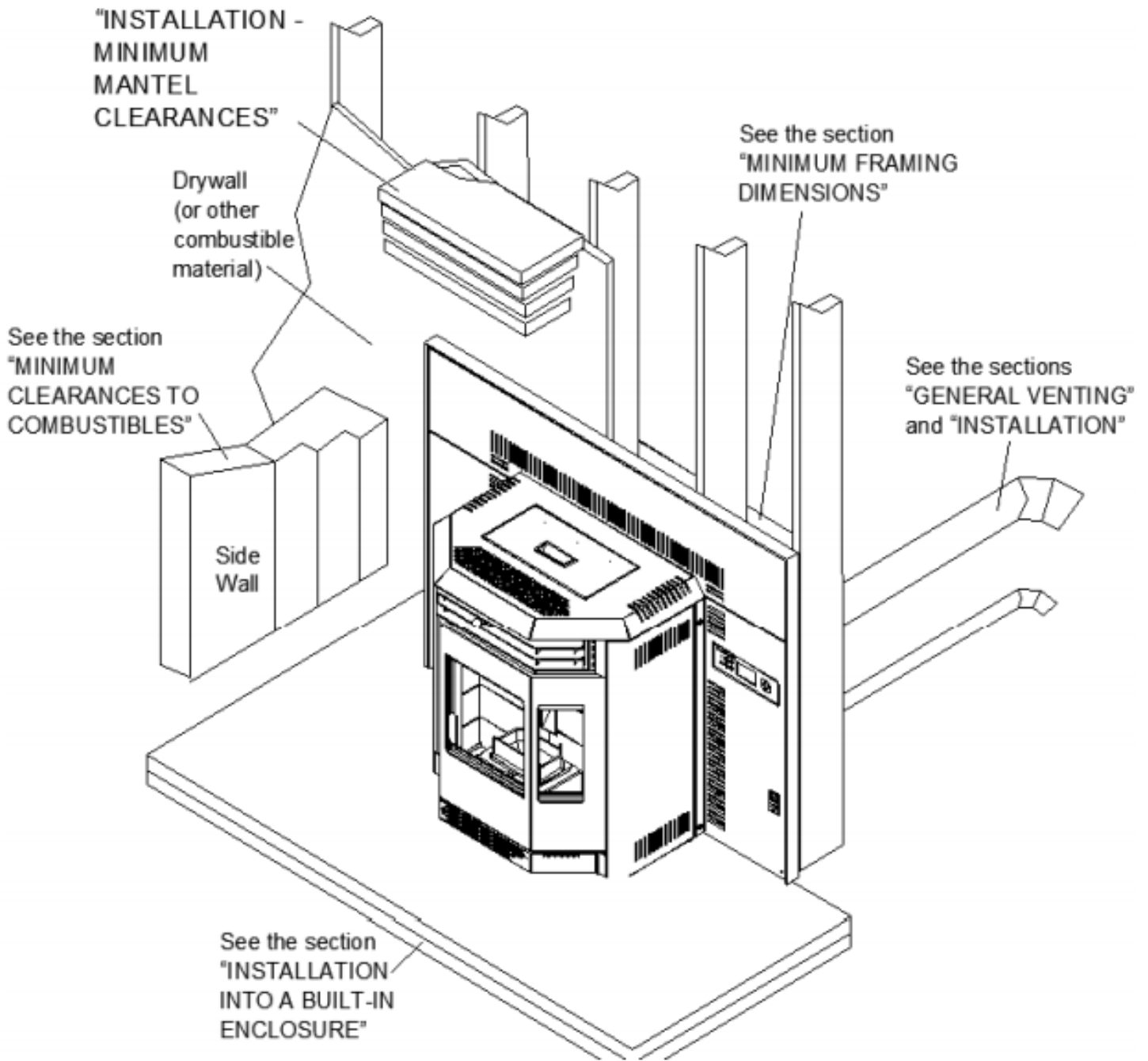

Figure 2

## GENERAL VENTING

### 1) Type of Vent

Must be an approved 3" or 4" diameter type "L" or "PL" vent, vented to the outside or connect the vent to a factory built type "A" chimney using an adapter; and/or stainless steel chimney liner for masonry fireplace installations. Use 4" diameter vent if vent or liner height exceeds 18' or if installation is over 5,000' above sea level.

### 2) Installing the Pellet Vent

The vent must have a support bracket every 5' when on the exterior wall. To achieve optimum performance, keep vent runs as short as possible, especially on horizontal installations.

**MAXIMUM VENTING:** Maximum venting distances are: 33' vertical, and 10' horizontal. Use no more than 180° of elbows (two 90° elbows, or two 45° elbows and one 90° elbow, etc...) excluding the Tee and Termination cap.

**VENT INSTALLATION:** Termination must exhaust above the air inlet, and parallel or above the exhaust output of the pellet stove. It is recommended that at least 3' of vertical pipe be installed to create some natural draft. This is to help prevent the possibility of smoke or odor entering the home during appliance shut down or in the event of a power outage. Horizontal sections must have a 1/4" rise every 12" of travel longer than 3'.

The pellet vent connections must be sealed with Hi-Temp RTV silicone and screwed together with at least 3 3/8" stainless steel screws. Seal each vent section by injecting a liberal amount of 500°F (260°C) RTV silicone sealant into the gap. We recommend sealing the outside connections to permit easier access when servicing.

### 3) Venting the Pellet Stove

Use an approved wall thimble when passing the vent through walls and a ceiling support/fire stop spacer when passing vent through ceilings. (Maintain a 3" clearance to any combustible.)

### 4) Pellet Vent Termination

The vent termination must have an approved cap (to prevent water from entering) or a 45° downturn. If the termination is located on a windy side of the house (windward), a shield is recommended to prevent soot from building up on the side of the house.

Horizontal terminations must protrude 12" from the wall, vertical terminations require a minimum 24" above the highest point that it penetrates through the roof.

Depending on pellet quality, vent configuration, and air settings, soot buildup may occur on terminal wall.



## WARNING

- Pellet vent must maintain a minimum 3" clearance to any combustible. (Install vent at clearances specified by the vent manufacturer.)
- Do not connect pellet vent to a vent or chimney serving any other appliance.
- Do not install a flue damper in the exhaust venting system of the unit.

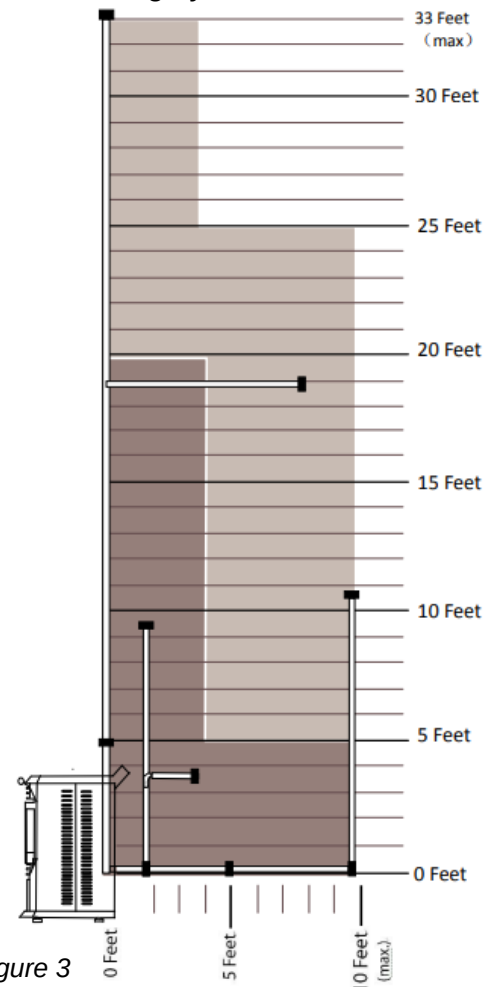

Figure 3

# MINIMUM TERMINATION CLEARANCES

**FIGURE 4**

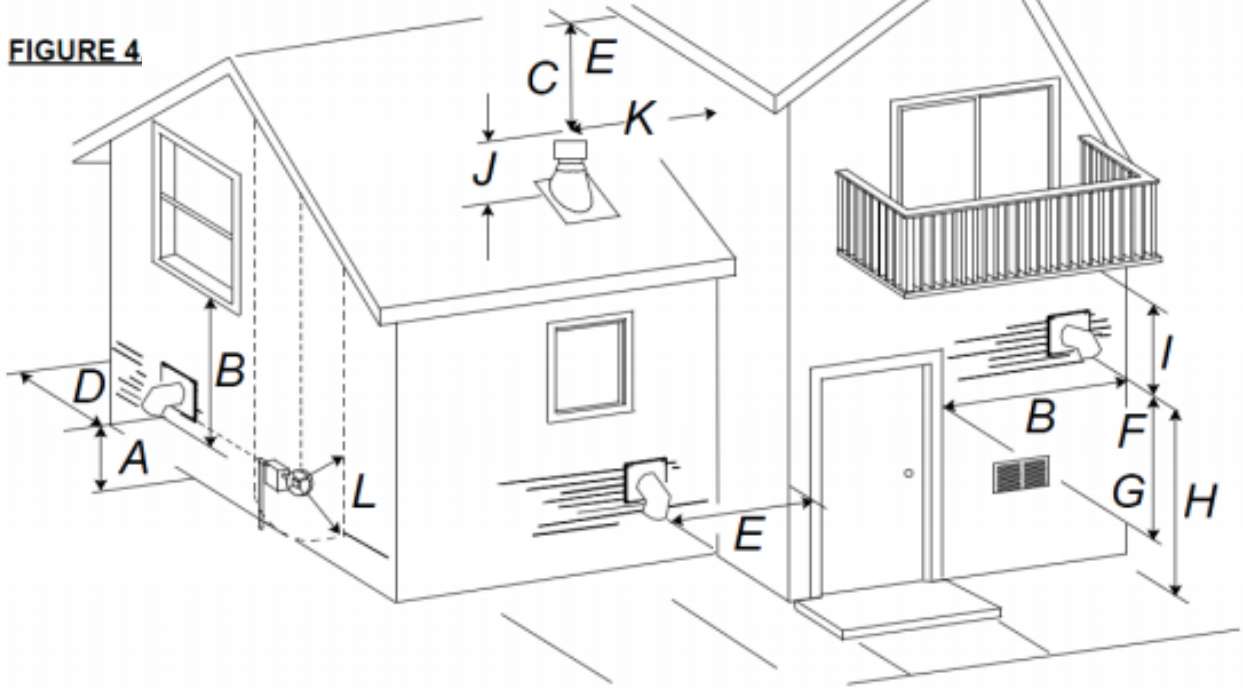

Illustration dimensions are to the center and the exhaust exit point of the vent.

CLEARANCE		
A	24 INCHES	Clearance above grade, veranda porch, deck or balcony. (Including Vegetation and Mulch)
B	48 INCHES	Clearance beside or below any windows or doors that open.
	12 INCHES*	Clearance above any window or door that opens.
C	18 INCHES	Vertical clearance to ventilated soffit located above the terminal within a horizontal distance of 2 feet from the centerline of the terminal.
D	0 INCHES	Clearance to an outside corner wall.
E	3 INCHES	Clearance to an inside combustible corner wall or protruding combustible obstructions ( vent chase, etc.).
F	48 INCHES	Clearance to a non-mechanical air supply inlet to the building or a combustion air inlet to any other appliance.
G	48 INCHES	Clearance to a mechanical air supply inlet.
H	7 FEET**	Clearance above a paved sidewalk or paved driveway located on public property.
I	12 INCHES**	Clearance under a veranda, porch, deck or balcony.
J	24 INCHES	Clearance above the roof.
K	2 FEET	Clearance from an adjacent wall including neighbouring buildings.
L	3 FEET within a height of 15 FEET above the meter/regulator assembly	Clearance to each side of center line extended above natural gas or propane meter/regulator assembly or mechanical vent.

\* Recommended to prevent condensation on windows and thermal breakage

\*\* This is a recommended distance. For additional requirements check local codes.

## INSTALLATION

### MASONRY HEATER INSTALLATION:

Prior to installation: Stand-offs may be removed to fit the insert into the fireplace.

When installing the insert into a masonry fireplace, do not remove any bricks or masonry. Do not weaken the structure, or reduce the protection for combustible materials to less than that required by the National Building Code.

Bolted or screwed together pieces (smoke shelf / deflectors) may be removed, but must be able to be re-installed if the heater was removed.

External trim pieces, which do not affect the operation of the fireplace, may be removed, provided they are able to be re-installed in the event the heater is removed.

A warning label must be attached to the back wall of the fireplace stating that "This fireplace has been altered to accommodate a fireplace insert and must be re-inspected by a qualified person prior to re-use as a factory built fireplace".

A non-combustible hearth must cover the flooring underneath, as well as extend a minimum of 6" in front and to both sides of the stove.

Clean all ashes out of the inside of the fireplace.

Make sure that the chimney and fireplace are free of cracks, loose mortar, creosote deposits, blockage, or other signs of deterioration. If necessary, have any repair work done by a qualified professional before installing the heater.

**A.** Remove the fireplace damper or fasten it permanently open.

**B.** Measure the throat of the fireplace and mark this shape on a piece of 24 gauge sheet metal (flue cover). Cut a hole, sized for the pellet liner, to lie directly below the fireplace flue opening. Allow 2" of material for a flange on all sides and cut to these measurements. Bend down the flanges. If you have never done this before, it might be a good idea to make a cardboard pattern and test it first. Fasten this flue cover in position as high as possible with two masonry screws per side through the flanges into the fireplace.

**C.** If you plan on connecting outside air it is recommended to do so at this time.

**D.** Install floor protection if necessary.

**E.** Connect the pellet vent with a Clean-Out-Tee to the back of the insert.

**F.** Run a liner down the chimney and connect to the Tee.

**G.** Position the insert in its final location.

**H.** Pull the excess length of the liner out through the top of the chimney. Trim the excess liner, install the cap the chimney.



## WARNING

- Do not remove bricks or mortar from the fireplace.

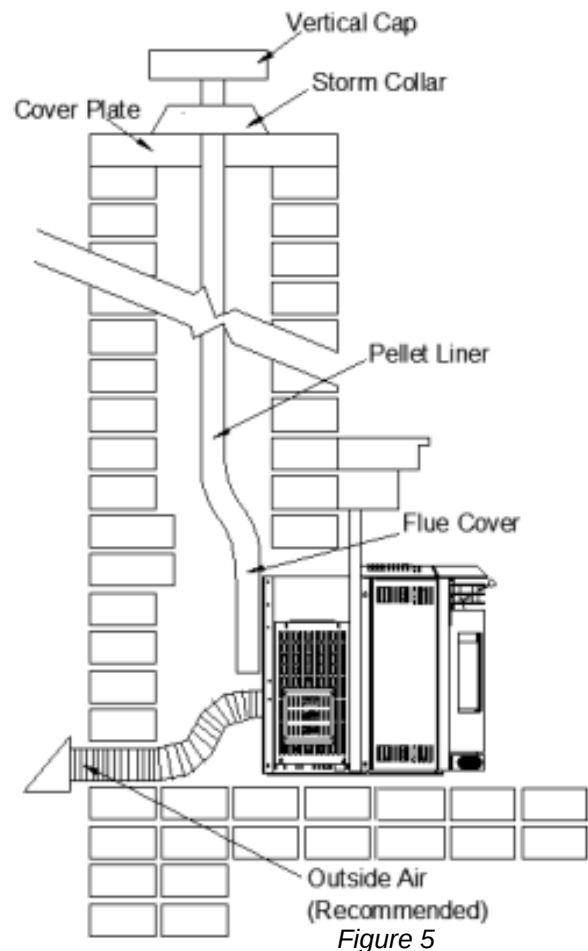

Figure 5

## FACTORY BUILT (METAL) HEATER INSTALLATION

**Prior to installation:** Stand-offs may be removed to fit the insert into the fireplace.

When installing the insert into a masonry fireplace, do not remove any bricks or masonry. Do not weaken the structure, or reduce the protection for combustible materials to less than that required by the National Building Code.

Bolted or screwed together pieces (smoke shelf / deflectors) may be removed, but must be able to be re-installed if the heater was removed.

External trim pieces, which do not affect the operation of the fireplace, may be removed, provided they are able to be re-installed in the event the heater is removed.

A warning label must be attached to the back wall of the fireplace stating that "This fireplace has been altered to accommodate a fireplace insert and must be re-inspected by a qualified person prior to re-use as a factory built fireplace".

A non-combustible hearth must cover the flooring underneath, as well as extend a minimum of 6" in front and to both sides of the stove.

Clean all ashes out of the inside of the fireplace.

Make sure that the chimney and fireplace are free of cracks, loose mortar, creosote deposits, blockage, or other signs of deterioration. If necessary, have any repair work done by a qualified professional before installing the heater.

**A.** Remove the fireplace damper or fasten it permanently open.

**B.** Measure the throat of the fireplace and mark this shape on a piece of 24 gauge sheet metal (flue cover). Cut a hole, sized

for the pellet liner, to lie directly below the fireplace flue opening. Allow 2" of material for a flange on all sides and cut to these measurements. Bend down the flanges. If you have never done this before, it might be a good idea to make a cardboard pattern and test it first. Fasten this flue cover in position as high as possible with two masonry screws per side through the flanges into the fireplace.

**C.** If you plan on connecting outside air it is recommended to do so at this time.

**D.** Install floor protection if necessary.

**E.** Connect the pellet vent with a Clean-Out-Tee to the back of the insert.

**F.** Run a liner down the chimney and connect to the Tee.

**G.** Position the insert in it's final location.

**H.** Pull the excess length of the liner out through the top of the chimney. Trim the excess liner, install the cap the chimney.

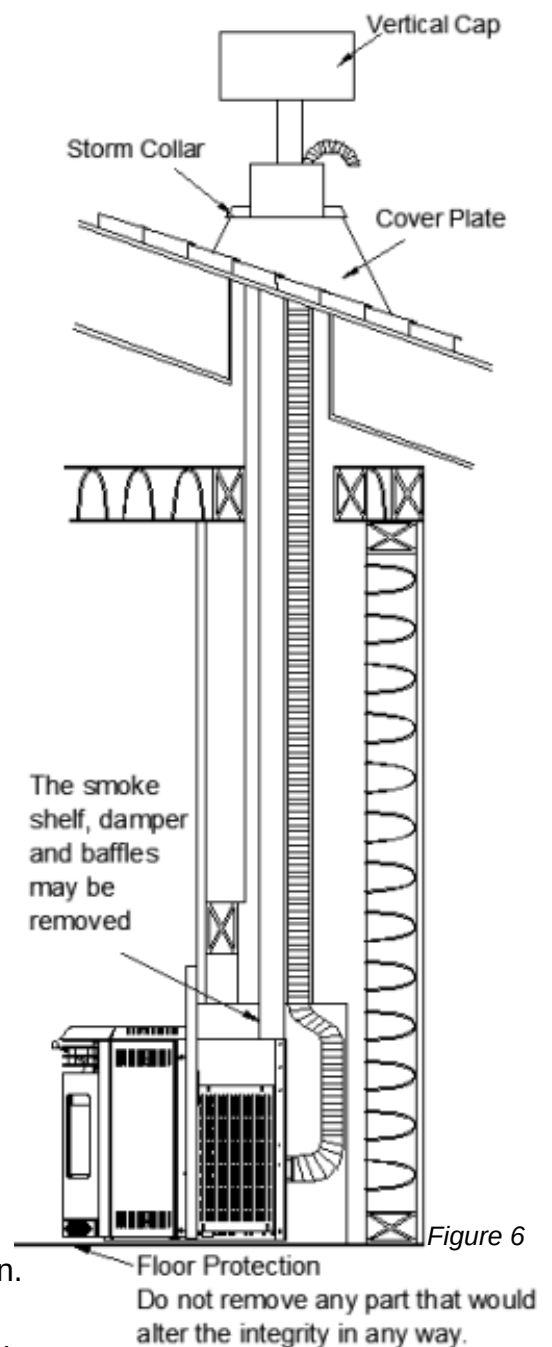

## INSTALLATION INTO A COMBUSTIBLE ENCLOSURE

When installing the insert as a "Built-in" heater, it is important to maintain the clearances to combustibles. See "Minimum Clearances to Combustibles" section.

### 1) FRAMING

A. Install floor protection.

B. Frame structure maintaining clearances. Locate and frame openings for both the exhaust and outside air. Outside air is mandatory for "Enclosure" installations.

C. Refer to the vent manufacturer's installation instructions and to "General Venting" section. Connect the vent.

D. Install surrounding panel. See "HP22I Finishing - surrounding Panel Installation" section.

E. Consideration must be taken during installation that removal of the insert is necessary for inspection and annual maintenance. Install the vent cap.



## WARNING

- The stand-offs located on the back of the insert must not be removed when installing the insert into a built-in combustible enclosure.
- Outside air is mandatory for a combustible built-in enclosure install.

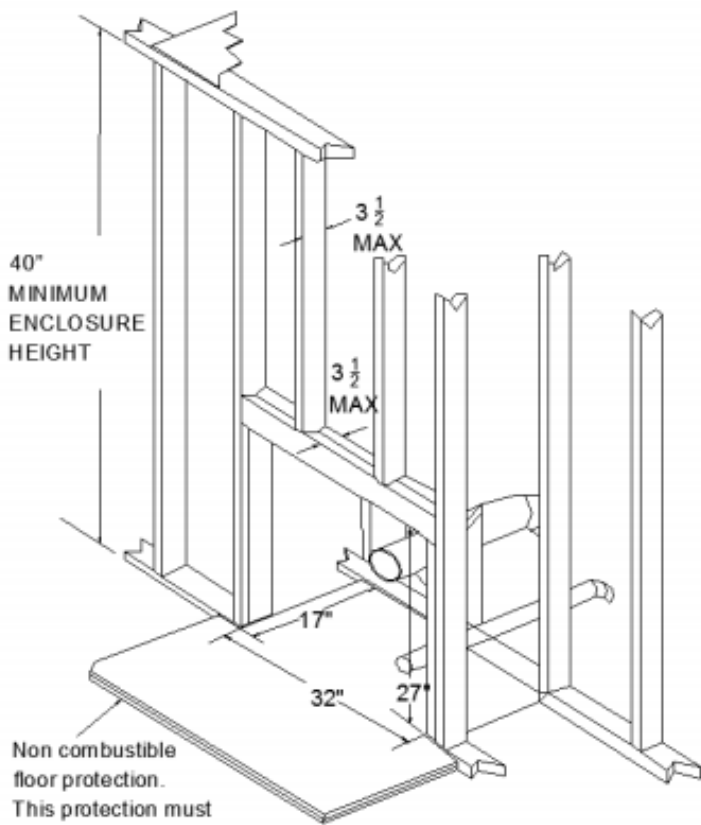

Figure 7

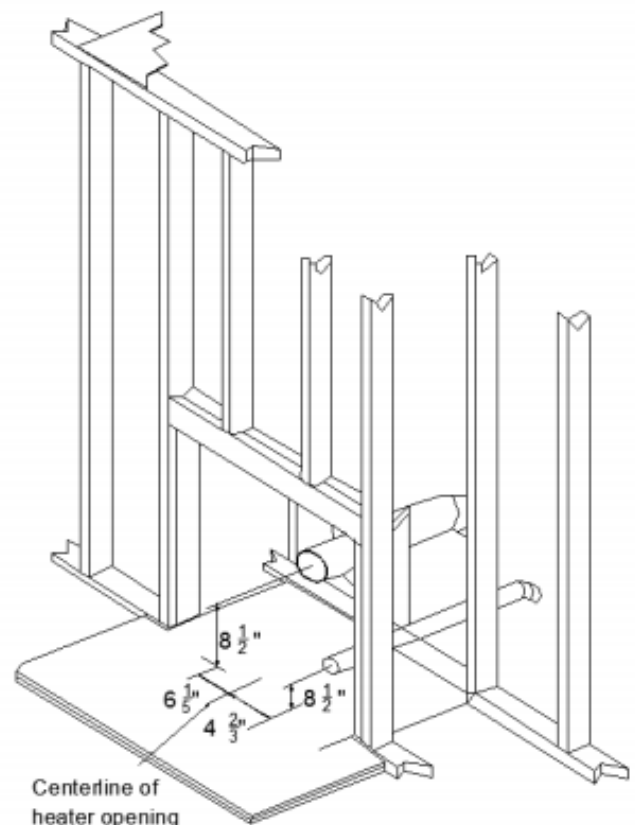
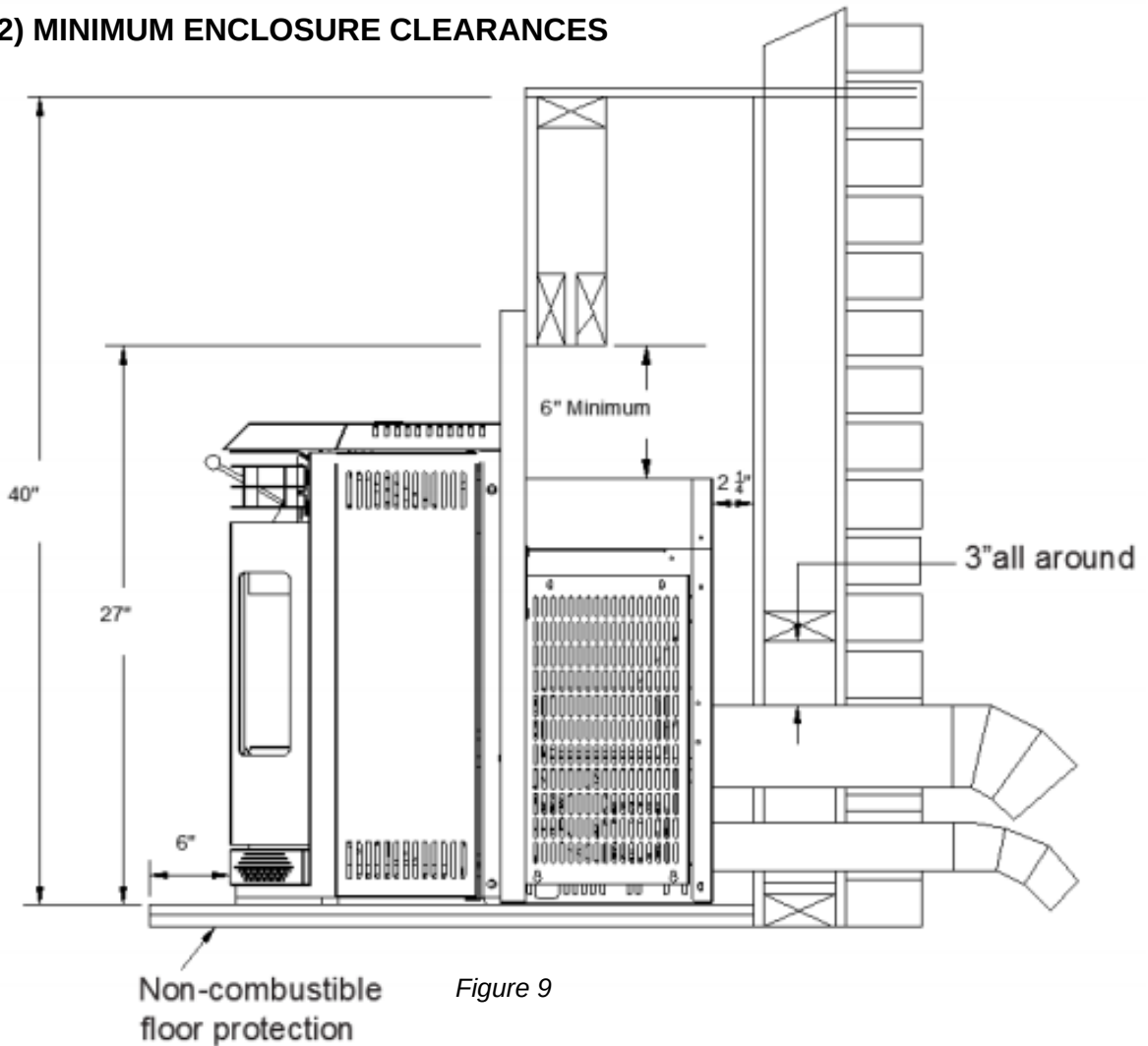

Figure 8

## 2) MINIMUM ENCLOSURE CLEARANCES



## 3) MINIMUM CLEARANCES TO COMBUSTIBLES

Side wall to heater	8"
Mantel to top of heater	8"
Top facing to heater	6 3/8"
Side facing to heater	6"
Floor protection*	6"

\*Floor Protection: Minimum 6" in front of door and to either side

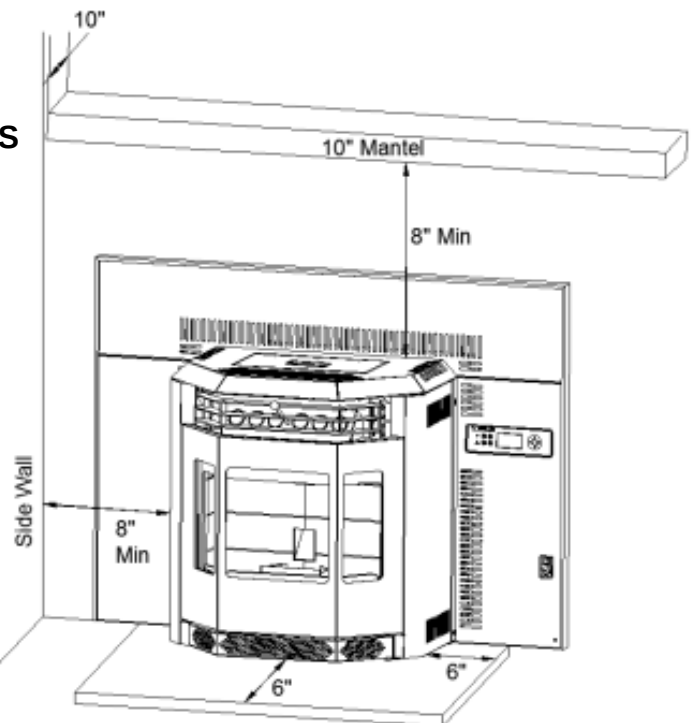



#### 4) MINIMUM MANTEL CLEARANCES

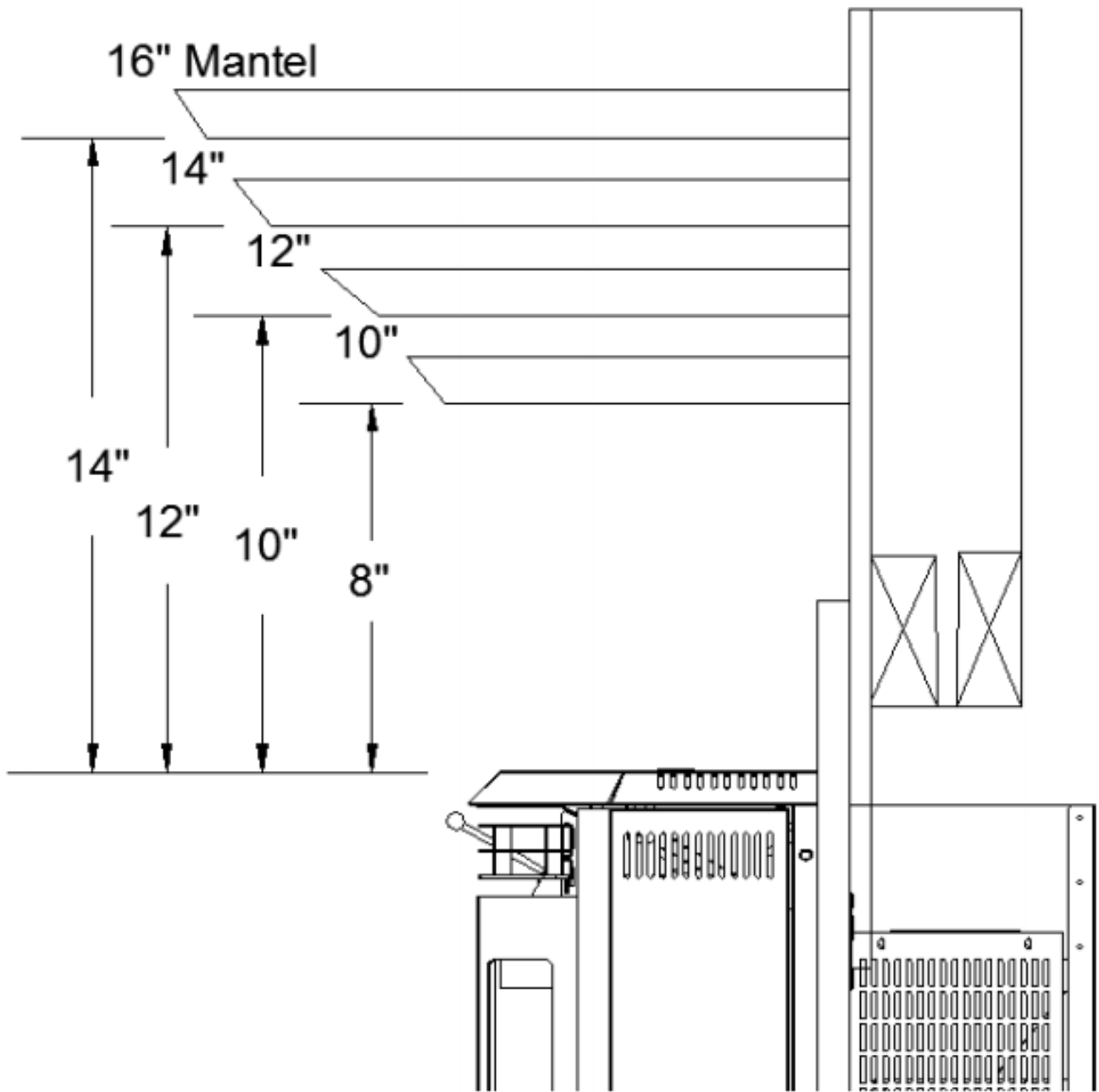

Figure 11

## INSERT FINISHING (SHROUD)

### 1) Surrounding Panel Installation

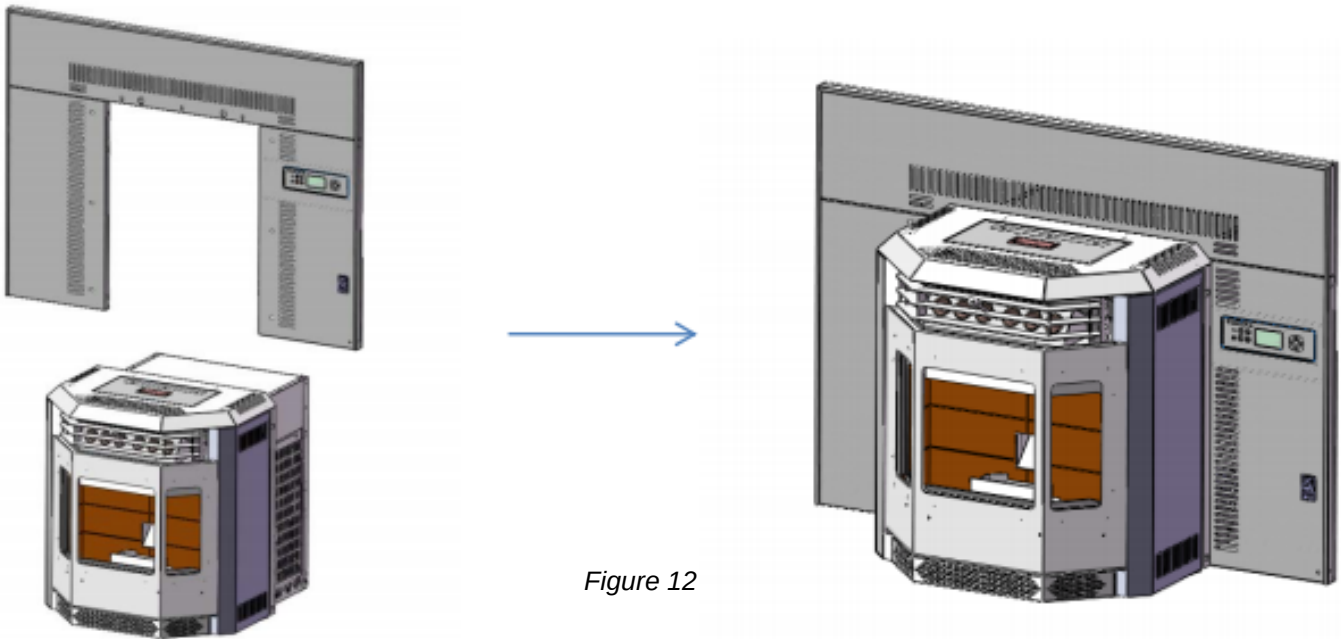
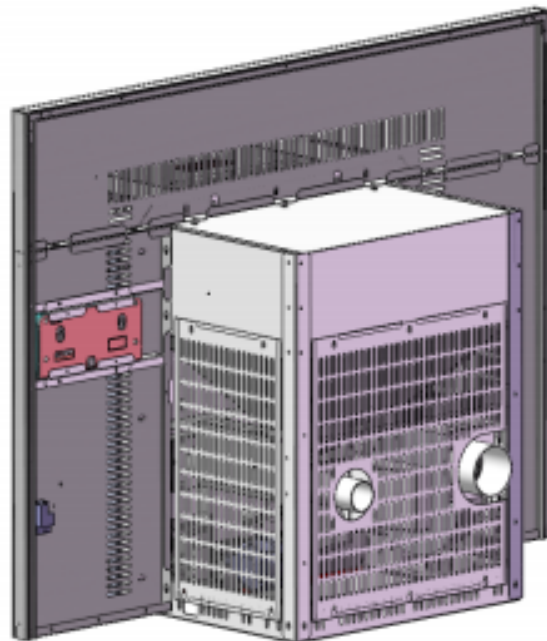

Figure 12

- Slide the surrounding panel assembly down over the insert body.
- Secure the panel using the six M6x20 screws.



- Connect the cable to the control panel.

Figure 13



## WARNING

- Never use flammable liquids such as gasoline, gasoline-type lighter fuel, charcoal, lighter fluid, or fire starting gels in or around the stove. Keep all such liquids well away from the stove when it is in use.
- Never open the side panels or main door when stove is in operation.
- Never touch door latches while in operation, they can get extremely hot.
- Never open glass door while stove is operating or while stove is hot.

### PRE-OPERATION

Once the stove has been properly installed and plugged into a grounded surge protector, you are ready to begin operation.

### PRIOR TO STARTING

- Turn on the main power switch located on the back of the stove. *See Figure 14*

**NOTE:** If for some reason the stove does not appear to be powering on, there is a fuse located just below the power switch that can be checked. A spare fuse is located inside the fuse holder if needed. *See Figure 15*



Figure 14: Power Switch



Figure 15: Spare Fuse

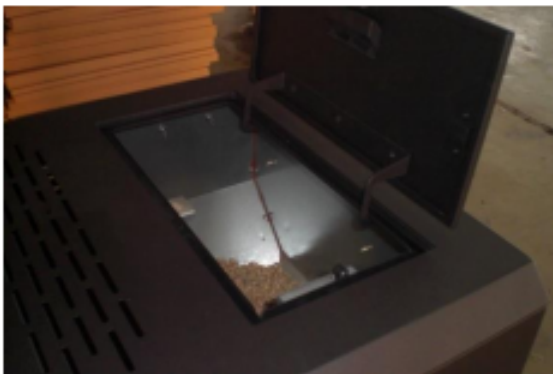

Figure 16: Pellet Load Hopper Lid

- Make sure the hopper is clean and free of foreign matter, including pellet fines and dust. Fill the hopper with wood pellets, making sure that NO parts of the bag or any foreign objects enter the hopper, as this may cause harm to the auger feed system. *See Figure 16*
- Also take care to ensure there is no pellet material in the hopper lid seating surfaces.
- Close the lid. This stove has a safety switch that will not allow pellets to feed with the hopper door open.
- Ensure the main glass door is closed. This stove has a safety switch that will not allow pellets to feed unless there is a negative pressure detected inside the stove.
- Before actually starting your stove, you will need to determine which operating mode you would prefer the stove to run in. This stove can operate in one of three modes.
  1. Manual: In this mode, you can personally adjust and set the heating power level to control the heat level.
  2. Thermostat Control (Temp): In this mode, you can set the room temperature and the stove will automatically adjust the heating power level to maintain the desired temperature.
  3. Weekly: In this mode, the stove will work automatically during days and times you predesignate. You can have a program for each of the 7 days of the week, and up to 4 periods during the day.

You must select your mode before turning on the stove.

Selecting a mode while the stove is burning may cause the stove to shut down and may force a 30-minute delay in restarting. You do not need to start operation of the stove to select your mode. To choose the mode, locate the mode transfer button on the controller. *(#6 in Figure 17)*

Pressing the mode button once selects Temp mode, pressing twice will select the Weekly mode, pressing a third time will return you back to Manual mode.

## OPERATION

After you have chosen the desired operation mode for your stove, press the ON/OFF button to start the stove ignite cycle. 

## START-UP

When the stove turns on, "Igniting" will appear in the work stage box on the screen.

Once the fire is lit, and the stove achieves operating temperature, the work stage box on the screen will read "Heating", and the room blower fan will engage.

During operation, the stove may display "Cleaning" periodically. This is an automatic cleaning that the stove will perform. \*see [#4 Set Ash Cleaning Cycle](#) on pg. 25 for more information.

## WORKING IN THE DIFFERENT OPERATION MODES

**To Change modes, press the "Mode Transfer Button" on the controller.**

### MANUAL MODE

The manual mode is the default mode setting if no other mode is chosen before the stove is turned on. In the manual mode, you have the ability to change the heat levels, which will increase or decrease the amount of heat that the stove puts out.

To change the power level in manual mode, use the "Scroll Up" or "Scroll Down" buttons on the control pad.

Pressing either of these buttons once will move the power level up or down one level.

*NOTE: This mode does not allow you to directly adjust specific temperatures. The manual mode simply allows you to dictate the level of heat the stove is outputting.*

### TEMPERATURE CONTROL MODE

The Temperature Mode allows you to set the temperature of the room. The stove will increase or decrease the level of heat it outputs automatically to keep the room at the set temperature. To increase or decrease the "Call to" temperature, use the "Scroll Up" or "Scroll Down" button. The current room temperature will be displayed in the temperature display box on the screen, as will the "Call to" temperature.

If the room temperature falls below the "call to" temperature, the stove's heat power level indicator will automatically rise to five. When the temperature has been reached, and maintained for about a minute, the heat power level will return to one and it will stay there until more heat is needed.

**NOTE:** In temperature mode, the stove will not shut off or go into standby. It will simply idle and continue to produce a fire until the room temperature falls below the "call to" temperature. When idling, the heat power level will read at level one in the power level box on the display screen.

### WEEKLY MODE

The Weekly Mode allows a user to control and schedule the stove operation during set times and days throughout the week. You can select four different operation times for each of the seven days of the week.

*IMPORTANT: Remember to set your weekly schedule in Weekly Mode before igniting a fire. If you attempt to set a weekly schedule while the stove is running in Manual or Temp modes, the weekly schedule will not set, and the screen will prompt you to wait until you have turned the stove off and it has cooled down before allowing you to retry.*

## GETTING FAMILIAR WITH THE CONTROLLER PANEL

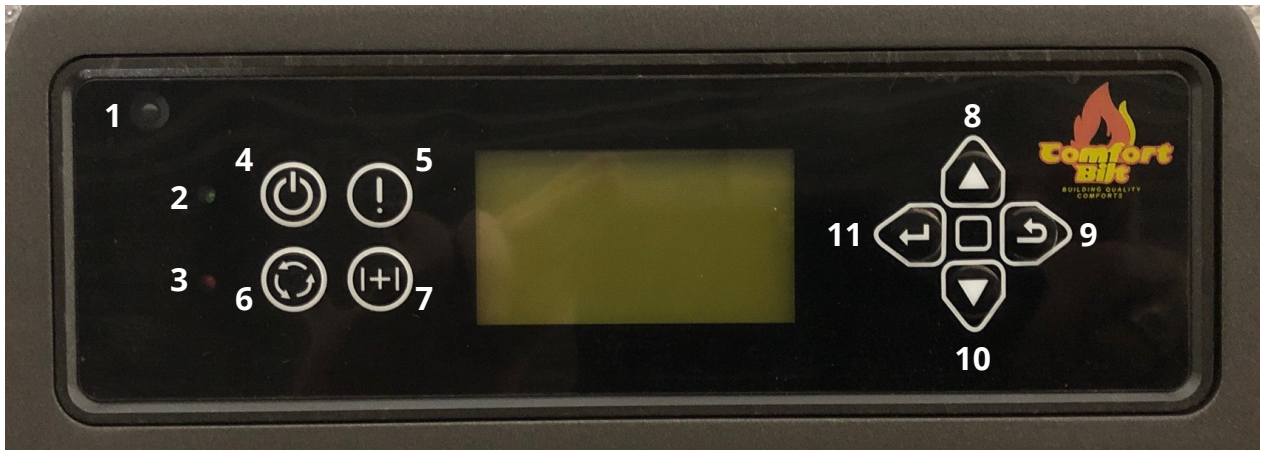

Figure 17: Control keypad

### CONTROLLER BUTTONS

- 1) Infrared Receiver:** Receives signal from remote control. (Available separately)
- 2) Power Indicator:** Illuminates when main power is switched on.
- 3) Alarm Light:** Illuminates if stove is not operating correctly.
- 4) On/Off Button:** Starts and stops operation of stove.
- 5) Information Button** (may look like clock-face): Allows you to read the real-time status of the stove at any time.
- 6) Mode Transfer Button:** Allows you to set the unit to one of four main mode settings: Manual, Temp, Weekly, and Thermostat.
- 7) Combination Function Button** (may look like lock): After you press this key, the "Key Combination" indicator will light. You can then press another key to complete an operation. See the combination key function list below:
  - Key 6:** Timer (use scroll up and down to change value)
  - Key 11:** Feeding (Used for newly installed stoves to prime the auger)
  - Key 9:** Stop Feeding
  - Key 4:** Child Lock (Hold Key 4 for 3 seconds to activate child lock. Hold Key 9 for 3 seconds to disengage child lock)
- 8) Scroll up Button:** Allows you to scroll up to choose items in the menu.
- 9) Exit Button:** Take you out of current selection and returns to previous option and/or screen. When entering data, pressing the EXIT button will delete your entries.
- 10) Scroll Down Button:** Allows you to scroll down to choose items in the menu.
- 11) Enter Button:** Pressing "Enter" button allows you to adjust and select data on the screen. Pressing the "Enter" button for 3 seconds will take you to a main menu screen in which you will have the ability to change the time, date, temperature display, weekly operation schedule (for Weekly Mode only) and combustion settings

## MAIN OPERATION CONTROLLER SCREEN DISPLAY

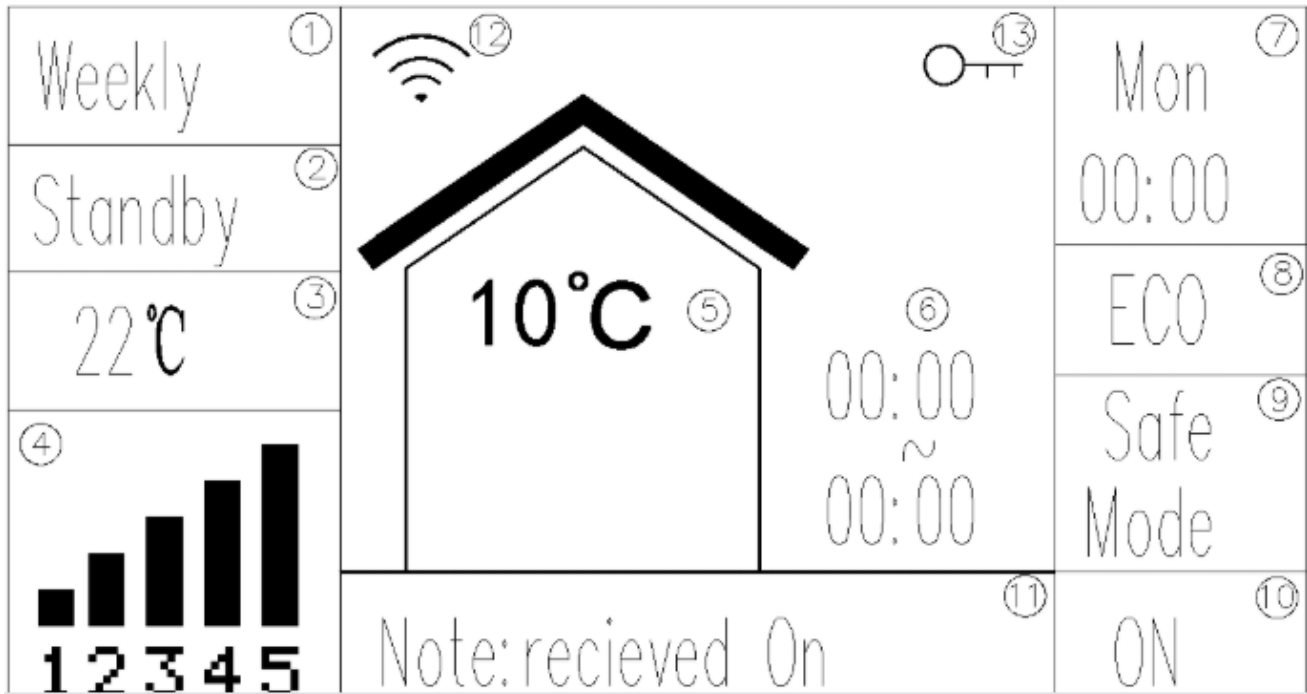

Figure 18: Display Screen

- 1) Mode:** Displays operation mode (Manual, Temp, Weekly, or Thermostat).
- 2) Work Stage:** Displays the operational stage the stove is currently in (i.e. Ignite, Heating, Fire Off, Standby, Stop, etc...)
- 3) Desired Temperature:** In Temp or Weekly mode, this will show the currently set temperature.
- 4) Heat Power Level:** Displays the current set Heat level. (In Manual mode, you can directly set this. In other modes, this will change based on other requirements set by the stove)
- 5) Current Temperature:** Displays the temperature that is being read by the temp-sensing wire.

- 6) Current Time Period:** In weekly mode, this displays the current time setting.
- 7) Day and Time:** Displays the day of the week and current time.
- 8) ECO Mode Indicator:** Displays the current status of the ECO settings (on of off)
- 9) Safe Mode Indicator:** If the vacuum or limit switches are being bypassed, the stove will operate in "Safe Mode".
- 10) On/Off Indicator:** Indicates if the stove is on and in operation or in the process of shutting down.
- 11) Information Bar:** Displays real-time messages such as operations by App.
- 13) Child Lock Indicator:** Indicates when child lock is currently active.

\*12) wifi mode is currently not used

## SETTING DATA ON YOUR CONTROLLER

- Press and hold the "Enter" button (#11, left arrow). This will take you to the "Set Data" screen.

---

### Set Data

---

- 1: General
  - 2: Set Weekly
  - 3: Set Combustion
  - 4: Set Ash Cleaning Cycle
  - 5: Set ECO
  - 6: Diagnosis
  - 7: Safe mode
  - 8: Information
  - 9: Set Blower
  - 10 Reset
- 

**1: General** - Press ENTER to access the "General" screen.

**1)** Press ENTER to highlight the hour. Use your SCROLL UP and SCROLL DOWN buttons to select the correct hour, and then press ENTER a second time to begin setting the minutes. Press Enter to highlight the day of week and setting. To change the hour, press ENTER. This will highlight the hour. Use your SCROLL UP and SCROLL DOWN buttons to choose the appropriate time. Press ENTER to select the correct hour, and then press ENTER a second time to begin setting the minutes.

**2)** Press ENTER to highlight the UNITS and set. Press ENTER again to exit the highlight.

**3)** Choose the language you want.

**2: Set Weekly** - Select "Set Weekly" and Press ENTER to access the "Weekly Schedule" screen.

**1)** In the "Weekly Schedule" screen, you can begin with selecting the target day of the week. Press ENTER to highlight the MON and use the SCROLL UP and SCROLL DOWN buttons to reach the target day. Press ENTER to confirm.

**2)** Move to Select the first time-setting line, you can begin with setting the operation times for Monday. Press ENTER to highlight the hour and use the SCROLL UP and SCROLL DOWN buttons until you reach your desired hour of start time. Press ENTER again to highlight the minutes and use SCROLL UP and SCROLL DOWN until you've reached your desired minute of start.

**NOTE: Your stove controller uses military time to set your weekly schedule.**

**3)** Pressing ENTER again will allow you to set the stop time of your stove. Use the same procedure for setting your stove's start time for selecting when you would like the stove to stop. Once you've selected the stop time, press ENTER.

**4)** Next you will have the opportunity to set the desired temperature. Use the SCROLL UP or SCROLL DOWN keys until you've reached the appropriate temperature for the times you have selected. Press ENTER.

**5)** "Yes" will now be highlighted. If you have set this particular time correctly, press ENTER. This will take you out of your first set time. If you wish to erase a scheduled time, use your ENTER key to highlight Yes on the screen for that scheduled time. Select "No" using your SCROLL UP OR SCROLL DOWN key. With "No" highlighted, press ENTER to erase the data.

6) To set another time for that particular day, press SCROLL DOWN and continue by repeating steps 2-5 as appropriate. NOTE: You must set your times in chronological order. The first schedule slot of one day MUST be earlier in the day than the second schedule slot on your weekly schedule list, etc.

7) Once you have set all times for Monday, SCROLL up to select "Monday" again and change to another day of week.

8) After you have set a particular time for a day, if you wish to set that time for every day of the week, Press the SCROLL up and Scroll down key to select and highlight "All". Pressing ENTER will then select that scheduled time and apply it to each day of the week.

9) Once you've finished setting your schedule, without any of the options highlighted, press the EXIT button. This will save your schedule.

10) With a schedule set, make sure that the main display screen on the controller reads "Weekly" (for operating in the Weekly Mode) and that the unit is turned on. The schedule will not take effect unless the unit is turned on in the Weekly Mode.

**3: Set Combustion** - Select "Set Combustion" and Press ENTER to access the "Combustion settings" screen.

1) Press to highlight the level and then change to the level need to set. Press again to exit highlight.

*Note: The level item has 8 options:*

*IG01 ,IG02, IG03 correspond to ignition stages.*

*H01, H02, H03, H04, H05 correspond to Heating stages.*

2) Move to "Feed rate". Press ENTER to highlight the value of on . Use your scroll up and scroll down button to choose the appropriate value. Press Enter to exit highlight and then the value of off is highlight. Use your scroll up and scroll down button to choose the appropriate value.

3) Move to "Exhaust Voltage", and press Enter to highlight the value behind the "Exhaust Voltage". Use your scroll up and scroll down button to choose the appropriate value.

**WARNING:** *The adjustments will affect emissions. Please contact the seller for advice before you want to change any setting.*

*The exhaust voltage (controlling the combustion motor) allows you to adjust the stove for the fuel you are burning or compensate for inadequate ventilation situations. In less than optimum venting situations, you can increase the exhaust speed for additional air circulation through the stove should ventilation be an issue.*

**IMPORTANT:** *Changing the exhaust voltage does NOT change the feed rate. Therefore, on high heat power levels where the feed rate is faster, a low voltage level will not push out enough air and the stove may overheat and pellets may back up into the pot. Decreasing exhaust voltage will increase the amount of heat coming into the room. Do not adjust the exhaust voltage too low, as it can cause pellets to backup in the burn pot.*

Increasing the exhaust voltage, and thereby increasing the amount of air in the burn pot, will also assist in burning lower quality fuels that may otherwise cause unwanted buildup.

**NOTE:** *Be sure to visually watch the burn rate if the combustion voltage is decreased, as to not cause pot overloading. Exhaust voltage should ONLY be adjusted to get the optimum performance out of the fuel you are burning.*



4) Move to "Blower voltage ", set the Correct value. The blower voltage (controlling the room fan) can be turned up or down for each power level to regulate the amount of heat circulated into a room during stove operation. Some fuels radiate heat better than others. You have the ability to speed up or slow down the room fan to extract the optimum amount of heat without blowing cold air. Increasing the blower voltage causes the convection motor to run faster, extracting more heat from the unit.

**NOTE:** *If having issues with the stove overtemping in any setting, increase the blower voltage. Decreasing the blower voltage allows you to slow the exchange of heat from the stove so it blows less cold air*

**4: Set Ash Cleaning Cycle** - Select "Set Ash Cleaning Cycle" and Press ENTER to access the "Ash Cleaning" screen.

The ash clean cycle displays 1: Time span (in minutes) and 2: Duration (in seconds).

*During the "Duration" time period, the feeding will pause and the exhaust fan will increase.*

*The period of normal operation between this "Duration" period is the "Time Span" and can be adjusted from 30 mins to 60 mins.*

*Smart Ash Cleaning is an automatic ash cleaning cycle and has 3 settings: Light, Medium, and Heavy.*

**5: Set ECO** - Select "Set ECO" and Press ENTER to access the "ECO setting" screen.

*When ECO is set to ON, the stove will do a "fire off" mode when the room temperature meets or exceeds the desired "call to" temperature.*

*When the thermostat calls for heating, the stove will restart and resume normal heating mode.*

*When ECO is set to OFF, the stove will idle (reduce to level 1) when the room temperature meets or exceeds the desired "call to" temperature.*

**6: Diagnostics** - Select "Diagnostics" and Press ENTER to access the "Diagnostics" screen.

**NOTE:** *You will only be able to enter the diagnostic screen when the stove is turned OFF.*

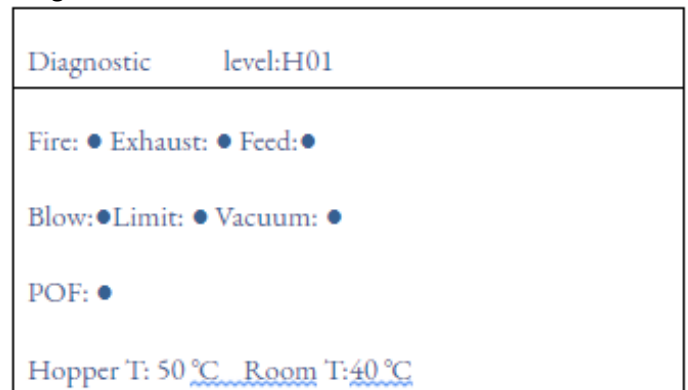

**Level:** Changing the level will allow you to test the component in the various heating power levels.

**Fire:** Indicates whether the igniter is working properly.

**Exhaust:** Indicates whether the combustion motor and exhaust system is working properly.

**Blower:** Indicates whether the room fan/blower is working properly.

**Feeding:** Indicates if the auger is properly feeding pellets.

**Limit:** Indicates the hopper lid is properly shut.

**Vacuum:** Indicates there is sufficient vacuum and suction.

**POF:** Indicates the proof of fire switch is properly working.

**Hopper T:** Indicates temperature being read by over temp sensor. (Temperature is in Celsius)

**Room T:** Indicates temperature being read by room temp sensor.

*In the diagnostic mode, you will have the ability to test certain components of your stove to see if they are properly working. By using the ENTER button, you can highlight "Fire," "Exhaust," "Blower," or "Feeder". When one of these options is highlighted, you can use the SCROLL UP or SCROLL DOWN buttons to shade in the circle next to the stove component it represents. This manually attempts to turn on these components to see if it works properly.*

**7: Safe Mode** - Select "Safe Mode" and Press ENTER to access the "Safe Mode Bypass" screen.

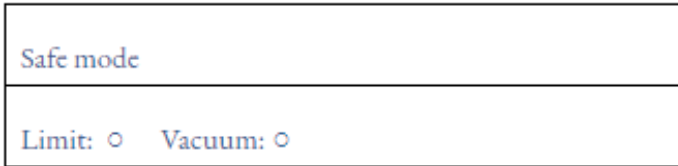

In the safe mode, you will have the ability to bypass these two components (Limit and Vacuum) of your stove to see if they are properly working.

**Note: This option is usually reserved for service technicians only. Please do not bypass without a proper understanding of the potential risks.**

**8: Information** - Select "Information" and Press ENTER to access the "Information" screen.

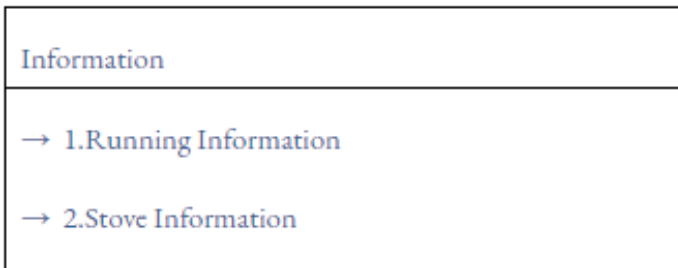

**1) Running Information** - Select "Running Information" and Press ENTER to access the "Running Information" screen.

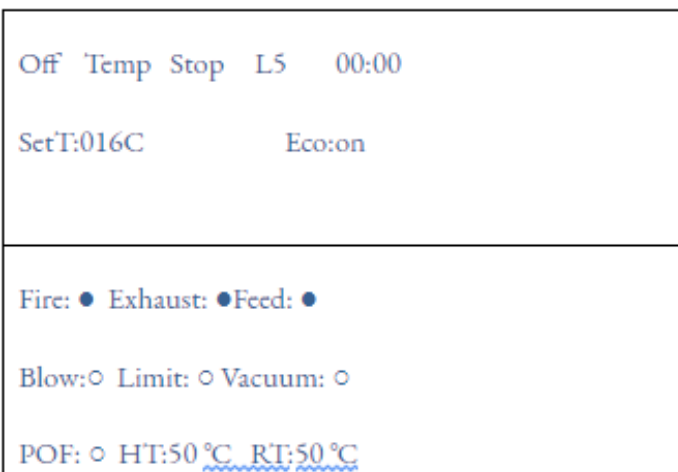

**2) Stove Information** - Select "Stove Information" and Press ENTER to access the "Stove Information" screen.

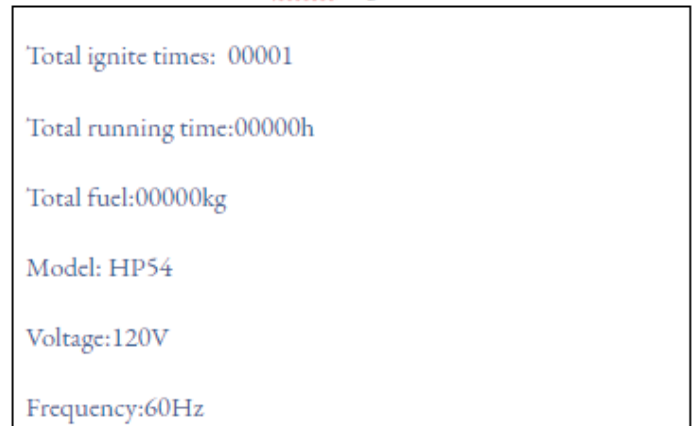

Total ignite times: Counts the times of ignite modes.

Total Running time: Total working time of the stove.

Total fuel: The total fuel consumption.

**9: Set Blower** - Lets you turn off the room blower completely.

**10: Reset** - Resets all settings back to factory defaults. Not advised without speaking to a service professional or ComfortBilt agent first.



## WARNING

- Never perform cleaning or maintenance on a hot stove.
- Allow unit to cool for a minimum of two hours.
- Never perform service with power supplied to the unit.
- Interior components may still be hot, even when stove surfaces are cool to the touch. A protective glove is recommended.
- Clinkers may remain hot for several minutes after they are pulled from the burn pot.

## MAINTENANCE

### NORMAL CARE AND MAINTENANCE

A majority of all problems with pellet stoves are either directly or indirectly related to general maintenance and cleaning issues. Regularly cleaning your stove will allow it to function properly and extends the life of most of the stove's components.

Due to differences in fuel quality, stove cleaning intervals can vary wildly. However, the cleaner the stove is, the more efficiently it will burn.

### GLASS FRONT DOOR

Only clean the glass when the glass is cool. Wipe the glass clean with a dry or damp rag. If this does not remove all build-up, use of any non-abrasive cleaner is approved. Using ceramic stove top cleaner can be helpful in removing soot build-up from the glass. **See**

**Figure 19**

Inspect the gaskets around the door periodically and replace any worn, frayed or compacted gaskets.

**NOTE: Only replace broken glass with high temperature ceramic glass.**

### SOOT AND FLY ASH

The products of combustion will contain small particles of fly ash. The fly ash will collect in the exhaust venting system and restrict the flow of the flue gasses. Incomplete combustion, which occurs during startup and shutdown, or incorrect operation of the stove, will lead to some soot formation collecting in the exhaust venting system. The exhaust venting system should be inspected regularly to determine if cleaning is necessary. If cleaning is necessary, disassemble the exhaust vent and clean the individual parts. When cleaning ash, use an approved ash vacuum.

Clean out T-vents regularly to determine the required cleaning interval. Use a 3" or 4" chimney brush to clean exhaust venting. Plugged venting will effect the quality of the fire. Make sure to clean any screens in the venting regularly as a plugged screen can restrict combustion air and cause the fire to burn poorly.

## CAUTION

- Do Not operate stove with broken glass
- Do Not slam doors shut.
- Do Not strike the glass.
- Do Not use abrasive cleaners.
- Do Not clean hot glass.
- Replace ceramic glass with factory authorized replacement parts only.



Figure 19: Front Door Glass

## DAILY MAINTENANCE

### BURN POT

Remove and clean the burn pot daily. Make sure all of the airflow holes in the burn pot are unobstructed. Using a small metal pick or drill bit can aid you if these get plugged through general use. Every time the hopper is filled with fuel, the burn pot should be emptied.

In order to empty the burn pot, lift it out of the cradle and dump it directly into the ash pan. Be sure any build-up is removed when clearing the airflow holes. *See Figure 20*



Figure 20: Burn Pot

## WEEKLY MAINTENANCE

### INTERIOR CHAMBER

In addition to the daily maintenance tasks, clean the interior chamber with an ash vacuum. (Ash vacuums have a metal canister that is specially designed to contain soot).

Remove the burn pot from the cradle and vacuum beneath. Be sure to remove any ash buildup in and around the igniter tube. *See Figure 21*

**NOTE: When cleaning/vacuuming out the igniter tube, ensure that the igniter rod does not get pushed out of position.**



Figure 21: Burn Pot Cradle/Igniter Tube

## CONTINUING MAINTENANCE

### EXHAUST & COMBUSTION ASSEMBLY

In addition to the daily and weekly maintenance tasks, the exhaust venting, and combustion motor, housing, and impellers should be inspected and cleaned once per year. *See Figure 22*

There is a combustion motor gasket, which allows you to remove the motor from the housing, for inspection and cleaning, without having to remove the entire exhaust fan. However, if you must remove or replace the entire exhaust fan, a new blower flange gasket should be added between the blower flange and the steel plate.

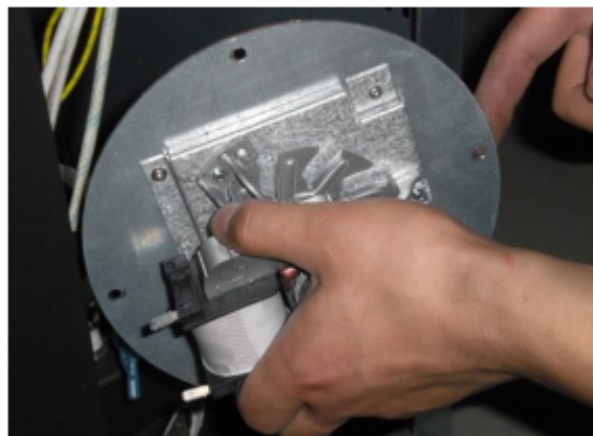

Figure 22: Combustion Motor Assembly

## REAR AIRFLOW/EXHAUST CHAMBER

In addition to daily and weekly maintenance tasks, the exhaust chamber covers should be removed and the entire chamber vacuumed thoroughly once every 1-2 tons of pellets burned. First, you will need to locate the cover plates to the rear exhaust chambers. These chamber covers are small, rectangular, metal plates that are affixed with 2 wing nuts. There are a total of 4 chamber covers. They are located on each side of the stove. (2 left, and 2 right - top and bottom). These are accessed via the side panels. **See Figures 23, 24, and 25**

Once you have located the chamber covers, you will then remove them by unscrewing the wing nuts and pulling the plate back. There is a gasket behind the plate to help make an airtight seal so the stove does not draw in air through these panels. It is ok to cut through the center of the gasket to access the chamber behind it. As long as there is adequate gasket material around the perimeter, it will provide a proper seal. Using a slender hose attachment on your ash vac, thoroughly vacuum out these chambers top to bottom. These chambers extend all the way up to the heat exchange tubes near the top of the stove, so it is imperative that the entire chamber is cleaned, top to bottom. Using a cross-hatching/sweeping motion will ensure that no area is neglected and as much of the ash and debris is removed as possible.



Figure 23: Exhaust Chamber Cover Plates.  
Air Intake side



Figure 24: Exhaust Chamber Cover Plates.  
Exhaust side



Figure 25: Exhaust Chamber Cover Plate.  
Gasket

## TROUBLESHOOTING & REPAIR

We build quality and durability into the design of our products; but no amount of careful design by us, and careful maintenance by you, can guarantee a repair free life for your stove. Most repairs will be minor, and easily fixed by following the suggestions in the troubleshooting guides on our website. The guides will help you pinpoint the causes of common problems and identify remedies. For more complicated repairs, you may want to rely on your retailer. [Troubleshooting & Component Guides](#) can be found on our website, as well as [YouTube videos](#). We will always be glad to answer any questions you may have, or help you find suitable assistance.

## WARRANTY

This warranty is non-transferable and is made to the original retail purchaser only, provided that the purchase was made through an authorized ComfortBilt dealer. It must be installed and operated in accordance with the Installation and Operating Instructions furnished with this product, as well as any applicable local and national codes. Any alteration, willful abuse, accident, or misuse of the product shall nullify this warranty.

SMG Hearth and Home LLC, a Manufacturing Company warrants this HP22 to be free from defects in the material or workmanship for a period of one year. During that one-year period, SMG will, at their discretion, furnish parts and labor to correct any defect caused by the faulty material or workmanship. For other warranty repairs, please read the One-Year Warranty listed below.

## ONE-YEAR WARRANTY

All electrical components such as, but not limited to, blowers, wiring, safety switches, controllers, igniters, and circuit boards are covered under SMG Hearth and Home LLC's One-Year Warranty.

Burn pots, and labor are also covered under the One-Year Warranty.

This warranty is limited to defective parts repair and/or replacement at SMG hearth and Home LLC's option, and excludes any incidental and consequential damages connected therein.

The warranty is not transferable and supersedes all other warranties either expressed or implied, and all other obligations to liabilities on our part. SMG Heath and Home LLC does not assume, and does not authorize any other person to assume for us, any liability in connection with the sale of our products. The warranty applies only to products which have not been subjected to negligent use, misuse, alteration, accident, or repairs made by anyone not certified by SMG Hearth and Home LLC.



SMG Hearth and Home LLC  
9241 Globe Center Dr. Suite 120  
Morrisville, NC 27560  
919-973-4092  
[www.comfortbilt.net](http://www.comfortbilt.net)

\*Technical service calls are answered  
Monday - Friday, 9am-5pm eastern time.

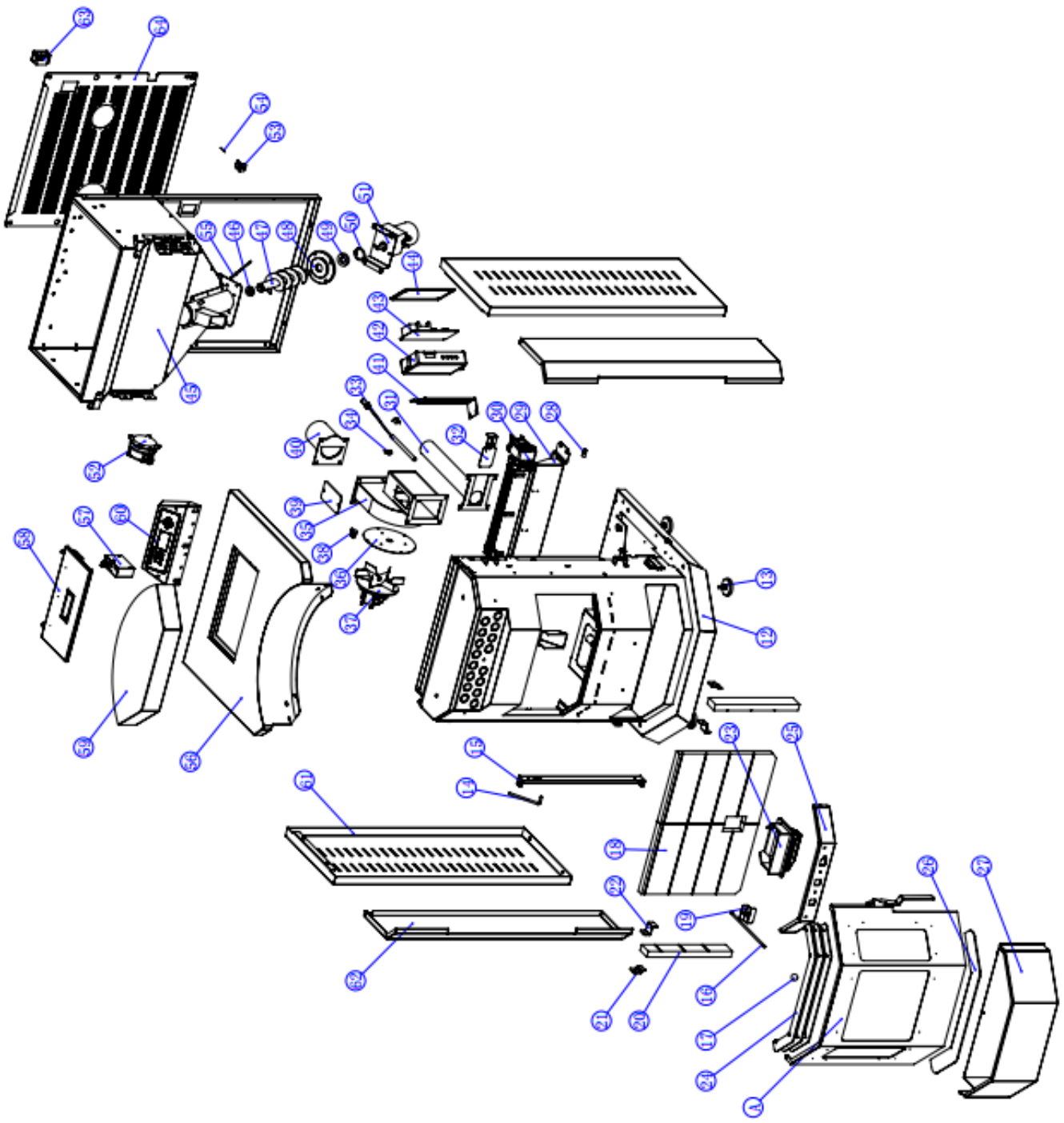

**Chassis and Paneling may differ by model**

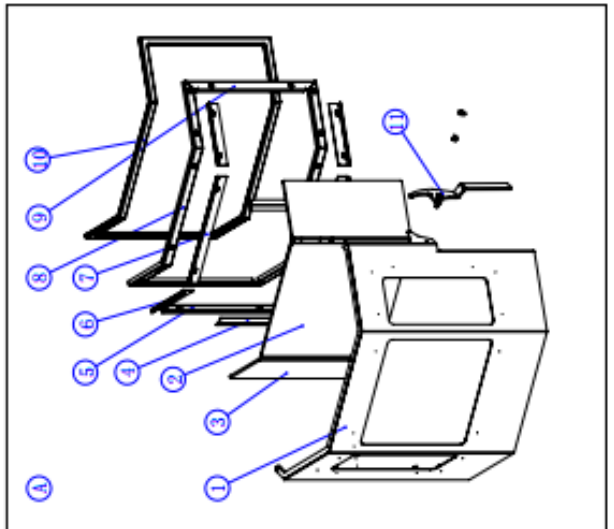

## PARTS EXPLOSION FOR HP22N

REPERE	DESCRIPTION	QTE
1	front door weldment	1
2	middle glass	1
3	side glass	2
4	middle glass holder	2
5	door glass holder 3	2
6	door glass holder 2	4
7	door glass holder 1	2
8	long sealing groove	2
9	short sealing groove	2
10	sealing rope	1
11	door handle weldment	1
12	firebox weldment	1
13	foot	4
14	vacuum tube	1
15	front door Hinge assembly	1
16	ash cleaning rod	1
17	ash cleaning rod knob	1
18	left back vermiculite	2
19	back vermiculite holder	1
20	side vermiculite	2
21	side vermiculite holder 1	2
22	side vermiculite holder 2	2
23	burn bot	1
24	air outlet weldment	1
25	air wash box	1
26	lower decorative plate	1

27	ash pan assembly	1
28	hook pin 1	2
29	blower bracket welement	1
30	blower	1
31	air income tube weldment	1
32	air income adjustment	1
33	ignitor	1
34	ignitor holder	2
35	exhaust blower holder flange 1	1
36	exhaust fan fixing plate	1
37	exhaust blower assembly	1
38	fire proof switch	2
39	cleaning cutout cover	2
40	venting connector weldment	1
41	power board holder	1
42	Power strip box 1	1
43	power board	1
44	Power strip box 2	1
45	hopper assembly	1
46	top bearing	1
47	auger weldment	1
48	bearing holder	1
49	bottom bearing	1
50	circlip	1
51	feed motor	1
52	vacuum switch	1

53	room sensor holder	1
54	room sensor	1
55	safty sensor	1
56	top panel assembly	1
57	hopper switch assembly	1
58	feed door	1
59	top decoration board	1
60	controller bracket assembly	1
61	left rear door	2
62	left door	2
63	power switch	1
64	back plate	1