

Protector™ Series

Diesel Generator Set

INCLUDES:

- Two Line LCD Multilingual Digital Evolution™ Controller (English/Spanish/French/Portuguese) with external viewing window for easy indication of generator status and breaker position.
- Isochronous electronic governor
- Sound attenuated aluminum enclosure
- Smart battery charger
- UV / Ozone resistant hoses
- ±1% voltage regulation
- Integrated base tank options are available with run times over 90 hours without having to refuel*
- Five year limited warranty
- UL 2200 / UL142 / ULC S601 Listed
- Meets code requirements for external vent and fill

Standby Power Rating

Model RD015 - 15 kW 60 Hz
 Model RD020 - 20 kW 60 Hz
 Model RD030 - 30 kW 60 Hz
 Model RD048 - 48 kW 60 Hz (single-phase only)
 Model RD050 - 50 kW 60 Hz (three-phase only)



QUIET-TEST



*Assembled in the USA using domestic and foreign parts

Meets EPA Emission Regulations
 CA/MA Emissions Compliant

* Time calculated at one-half maximum kW output.

FEATURES

- **INNOVATIVE DESIGN & PROTOTYPE TESTING** are key components of GENERAC'S success in "IMPROVING POWER BY DESIGN." But it doesn't stop there. Total commitment to component testing, reliability testing, environmental testing, destruction and life testing, plus testing to applicable CSA, NEMA, EGSA, and other standards, allows you to choose GENERAC POWER SYSTEMS with the confidence that these systems will provide superior performance.
- **TEST CRITERIA:**
 - ✓ PROTOTYPE TESTED
 - ✓ SYSTEM TORSIONALTESTED
 - ✓ NEMA MG1-22 EVALUATION
 - ✓ MOTOR STARTING ABILITY
- **TRUE POWER™ ELECTRICAL TECHNOLOGY:** Superior harmonics and sine wave form produce less than 5% Total Harmonic Distortion for utility quality power. This allows confident operation of sensitive electronic equipment and micro-chip based appliances, such as variable speed HVAC systems.
- **SOLID-STATE, FREQUENCY COMPENSATED VOLTAGE REGULATION:** This state-of-the-art power maximizing regulation system is standard on all Generac models. It provides optimized FAST RESPONSE to changing load conditions and MAXIMUM MOTOR STARTING CAPABILITY by electronically torque-matching the surge loads to the engine. Digital voltage regulation at ±1%.
- **SINGLE SOURCE SERVICE RESPONSE** from Generac's extensive dealer network provides parts and service know-how for the entire unit, from the engine to the smallest electronic component.
- **GENERAC TRANSFER SWITCHES:** Long life and reliability are synonymous with GENERAC POWER SYSTEMS. One reason for this confidence is that the GENERAC product line includes its own transfer systems and controls for total system compatibility.

15 • 20 • 30 • 48 • 50 kW

Application and Engineering Data

GENERATOR SPECIFICATIONS

Type	Synchronous
Rotor Insulation Class	H (15 & 20 kW) or F (30, 48, & 50 kW)
Stator Insulation Class	H
Telephone Interference Factor (TIF)	<50
Alternator Output Leads 1-Phase	Three wire
Alternator Output Leads 3-Phase	Six wire
Bearings	Single Sealed Cartridge
Coupling	Direct, Flexible Disc
Excitation System	Direct
Total Harmonic Distortion	< 5%

VOLTAGE REGULATION

Type	Electronic
Sensing	Single-phase
Regulation	± 1%
Features	Adjustable voltage & gain

GOVERNOR SPECIFICATIONS

Type	Electronic isochronous
Steady State Regulation	± 0.25%

ELECTRICAL SYSTEM

Battery Charge Alternator	50 amp (15 & 20 kW), 65 amp (30 kW), and 50 amp (48 & 50 kW)
Static Battery Charger	2 amp
Recommended Battery (battery not included)	Group 27F, 700 CCA Group 31, 925 CCA batteries can also be used with 30kW units
System Voltage	12 volts

ALTERNATOR SPECIFICATIONS

Revolving field heavy duty generator
 Directly connected to the engine
 Operating temperature rise 120 °C above a 40 °C ambient
 Class H insulation is NEMA rated
 Class F insulation is NEMA rated
 All models fully prototype tested

ENCLOSURE FEATURES

Aluminum weather protective enclosure	Provides protection against mother nature. Electrostatically applied textured epoxy paint for added durability.
Enclosed critical grade muffler	Quiet, critical grade muffler is mounted inside the unit to prevent injuries and maximize sound dampening.
Small, compact, attractive	Makes for an easy, eye appealing installation.
SAE	Sound attenuated enclosure ensures quiet operation.

ENGINE SPECIFICATIONS: 15 & 20 kW

Make	Mitsubishi
Model	In-line
Cylinders	4
Displacement (Liters)	2.5
Bore (in / mm)	3.46 / 88
Stroke (in / mm)	4.06 / 103
Compression Ratio	22:1
Intake Air System	Naturally aspirated
Cylinder Head Type	Cast iron OHV
Piston Type	Aluminum

ENGINE SPECIFICATIONS: 30 kW

Make	Perkins
Model	In-line
Cylinders	4
Displacement (Liters)	2.2
Bore (in / mm)	3.30 / 84
Stroke (in / mm)	3.94 / 100
Compression Ratio	23.3:1
Intake Air System	Turbocharged / aftercooled
Cylinder Head Type	Cast iron OHV
Piston Type	Aluminum

ENGINE SPECIFICATIONS: 48 & 50 kW

Make	Mitsubishi
Model	In-line
Cylinders	4
Displacement (Liters)	3.3
Bore (in / mm)	3.70 / 94
Stroke (in / mm)	4.72 / 120
Compression Ratio	19:1
Intake Air System	Turbocharged / Aftercooled
Cylinder Head Type	Cast iron OHV
Piston Type	Aluminum

ENGINE LUBRICATION SYSTEM

Oil Pump Type	Gear
Oil Filter Type	Full flow spin-on canister
Crankcase Capacity (quarts / Liters)	6.87 / 6.5—15 & 20 kW 11.2 / 10.6—30 kW 11.6 / 11—48 & 50 kW

ENGINE COOLING SYSTEM

Water Pump	Pre-lubed, self-sealing
Fan Speed (rpm)	2376—15 & 20 kW 1980—30 kW 2340—48 & 50 kW
Fan Diameter (in / mm)	18.11 / 460 (15 & 20 kW) 18 / 457.2 (30 kW) 17 / 431.8 (48 & 50 kW)
Fan Mode	Pusher

FUEL SYSTEM

Fuel Type	Ultra low sulfur diesel fuel
Fuel Pump Type	Mechanical engine driven gear
Injector Type	Mechanical
Fuel Supply Line (mm / in)	7.94 / 0.31 (ID)
Fuel Return Line (mm / in)	N/A—15 & 20 kW 4.76 / 0.19 (ID)—30 kW 7.94 / 0.31 (ID)—48 & 50 kW
Fuel Specification	ASTM
Fuel Filtering (microns)	6—15 & 20 kW 25—30 kW 6—48 & 50 kW

WEIGHTS AND DIMENSIONS

kW size	Tank size	Weight (lb / kg)	Dimensions (L x W x H) (in / cm)
15 kW	32 Gal	1528 / 693	81 x 31 x 51 / 206 x 79 x 129
	95 Gal	1757 / 797	81 x 31 x 61 / 206 x 79 x 165
20 kW	32 Gal	1528 / 693	81 x 31 x 51 / 206 x 79 x 129
	95 Gal	1757 / 797	81 x 31 x 61 / 206 x 79 x 165
30 kW	57 Gal	1857 / 842	95 x 35 x 59 / 241 x 89 x 150
	132 Gal	2070 / 939	95 x 35 x 68 / 241 x 89 x 173
48 & 50 kW	57 Gal	2215 / 1102	95 x 35 x 57 / 241 x 89 x 145
	132 Gal	2429 / 1102	95 x 35 x 66 / 241 x 89 x 168

15 • 20 • 30 • 48 • 50 kW

Application and Engineering Data

TANK SPECIFICATIONS

kW size		Total Capacity		Usable Capacity		Run Time at 1/2 Load (hrs)	
		gal / L	gal / L	gal / L	gal / L	hrs	hrs
15 kW	32 Gal Tank	32	127	32	121	39	
	95 Gal Tank	98.5	372.9	95	359.6	115.8	
20 kW	32 Gal Tank	32	127	32	121	31	
	95 Gal Tank	98.5	372.9	95	359.6	92.2	
30 kW	57 Gal Tank	61	233	57	215	41.6	
	132 Gal Tank	138.5	524	132	500	96.4	
48 & 50 kW	57 Gal Tank	62	234.7	57	215	28.2	
	132 Gal Tank	138.5	524	132	500	65.3	

GENERATOR OUTPUT VOLTAGE / KW-60 HZ

Model	Voltage / Phase / pf	kW (standby)		Amp (standby)		kW (Prime)		Amp (Prime)		CB Size
		standby	standby	standby	standby	Prime	Prime	Prime	Prime	
RD015	120/240 V, 1Ø, 1.0 pf	15	62	12	50	70				
	120/208 V, 3Ø, 0.8 pf	15	52	12	42	60				
	120/240 V, 3Ø, 0.8 pf	15	45	12	36	50				
RD020	120/240 V, 1Ø, 1.0 pf	20	83	16	67	100				
	120/208 V, 3Ø, 0.8 pf	20	69	16	56	80				
	120/240 V, 3Ø, 0.8 pf	20	60	16	48	70				
RD030	120/240 V, 1Ø, 1.0 pf	30	125	24	100	150				
	120/208 V, 3Ø, 0.8 pf	30	104	24	83	125				
	120/240 V, 3Ø, 0.8 pf	30	90	24	72	100				
	277/480 V, 3Ø, 0.8 pf	30	45	24	36	50				
RD048	120/240 V, 1Ø, 1.0 pf	48	200	38.4	183	200				
	120/208 V, 3Ø, 0.8 pf	50	173	40	153	200				
RD050	120/240 V, 3Ø, 0.8 pf	50	150	40	132	175				
	277/480 V, 3Ø, 0.8 pf	50	75	40	66	90				

SURGE CAPACITY IN AMPS

Model	Voltage	Voltage Dip @ < 0.4 pf	
		15%	30%
		amps	amps
RD015	120/240 V, 1Ø	53	129
	120/208 V, 3Ø	37	90
	120/240 V, 3Ø	32	78
RD020	120/240 V, 1Ø	87	211
	120/208 V, 3Ø	59	143
	120/240 V, 3Ø	51	124
RD030	120/240 V, 1Ø	66	168
	120/208 V, 3Ø	59	144
	120/240 V, 3Ø	51	125
RD048	120/240 V, 1Ø	69	189
	120/208 V, 3Ø	90	218
	120/240 V, 3Ø	78	189
RD050	277/480 V, 3Ø	36	87

ENGINE FUEL CONSUMPTION

Model	Load	gal / hr	L / hr
RD015	25% of rated load	0.60	2.27
	50% of rated load	0.85	3.22
	75% of rated load	1.10	4.16
	100% of rated load	1.46	5.53
RD020	25% of rated load	0.77	2.9
	50% of rated load	1.03	3.90
	75% of rated load	1.46	5.53
	100% of rated load	1.97	7.46
RD030	25% of rated load	0.97	3.67
	50% of rated load	1.37	5.19
	75% of rated load	1.97	7.46
	100% of rated load	2.77	10.49
RD048	25% of rated load	1.23	4.66
	50% of rated load	2.02	7.66
	75% of rated load	3.02	11.43
	100% of rated load	4.02	15.22

15 • 20 • 30 • 48 • 50 kW

ENGINE COOLING

	15 kW	20 kW	30 kW	48 kW & 50 kW
Air flow (inlet air including alternator and combustion air in cfm / cmm)	2750 / 78	2750 / 78	2800 / 79	2824 / 80
System coolant capacity (gal / Liters)	3.0 / 11.4	3.0 / 11.4	2.5 / 9.5	3.0 / 11.4
Heat rejection to coolant (BTU per hr / MJ per hr)	95,220 / 100.5	95,220 / 100.5	128,638 / 135.7	135,900 / 143.4
Maximum operation air temperature on radiator (°C / °F)	50 / 122			
Maximum ambient temperature (°C / °F)	50 / 122			

COMBUSTION REQUIREMENTS

	15 kW	20 kW	30 kW	48 kW & 50 kW
Flow at rated power (cfm / cmm)	86.3 / 2.4	86.3 / 2.4	88 / 2.5	190 / 5.38

SOUND EMISSIONS

Sound output in dB(A) at 23 ft (7 m) with generator in exercise mode*	65			
Sound output in dB(A) at 23 ft (7 m) with generator operating at normal load*	70			

EXHAUST

Exhaust flow at rated output (cfm / cmm)	98.88 / 2.8	98.88 / 2.8	296.6 / 8.4	448 / 12.7
Exhaust temperature at rated output (°C / °F)	482 / 900	482 / 900	499 / 930	499 / 930

ENGINE PARAMETERS

Rated Synchronous Rpm	1800			
HP at rated kW	26.4	33.5	49	85

POWER ADJUSTMENT FOR AMBIENT CONDITIONS

Temperature Deration	3% for every 5 °C above 25 °C or 1.7% for every 5 °F above 77 °F
Altitude Deration (15, 30, 48, and 50 kW)	1% for every 100 m above 915 m or 3% for every 1,000 ft above 3,000 ft
Altitude Deration (20 kW)	1% for every 100 m above 305 m or 3% for every 1,000 ft above 1,000 ft

CONTROLLER FEATURES

2-Line Plain Text Multilingual LCD Display	Simple user interface for ease of operation
Mode Buttons: Auto	Automatic Start on Utility failure. Programmable 7 day exerciser
Manual	Start with starter control, unit stays on. If utility fails, transfer to load takes place
Off	Stops unit. Power is removed. Control and charger still operate
Ready to Run/Maintenance Message	Standard
Engine Run Hours Indication	Standard
Programmable start delay between 2-1500 seconds	Standard (programmable by dealer only)
Utility Voltage Loss/Return to Utility Adjustable	From 140-171 V/190-216 V
Future Set Capable Exerciser/Exercise Set Error Warning	Standard
Run/Alarm/Maintenance Logs	50 Events Each
Engine Start Sequence	Cyclic cranking: 16 sec on, 7 rest (90 sec maximum duration)
Starter Lock-out	Starter cannot re-engage until 5 seconds after engine has stopped
Smart Battery Charger	Standard
Charger Fault/Missing AC Warning	Standard
Low Battery/Battery Problem Protection and Battery Condition Indication	Standard
Automatic Voltage Regulation with Over and Under Voltage Protection	Standard
Under-Frequency/Overload/Stepper Overcurrent Protection	Standard
Safety Fused/Fuse Problem Protection	Standard
Automatic Low Oil Pressure	Standard
Overcrank/Overspeed (@ 72 Hz)/rpm Sense Loss Shutdown	Standard
High Engine Temperature Shutdown	Standard
Internal Fault/Incorrect Wiring Protection	Standard
Common External Fault Capability	Standard
Field Upgradeable Firmware	Standard
Low Coolant Level Shutdown	Standard

15 • 20 • 30 • 48 • 50 kW

D2.5L G2 32 Gal Tank (1 of 2)

Installation Drawings

- NOTES:**
- MINIMUM RECOMMENDED CONCRETE PAD SIZE: 1092 (43") WIDE X 1887 (74.3") LONG. ALL DIMENSIONS ARE TO CENTER OF GRAVITY.
 - ALLOW SUFFICIENT ROOM ON ALL SIDES OF THE GENERATOR FOR MAINTENANCE AND SERVICING. THIS UNIT MUST BE INSTALLED IN ACCORDANCE WITH CURRENT APPLICABLE NFPA 37 AND NFPA 70 STANDARDS AS WELL AS ANY OTHER FEDERAL, STATE, AND LOCAL CODES.
 - SEE SPECIFICATION SHEET OR OWNERS MANUAL.
 - ACCESSIBLE THROUGH CUSTOMER ACCESS ASSEMBLY DOOR ON REAR OF GENERATOR.
 - REMOVE THE REAR STUB-UP AND REAR ENCLOSURE COVER PANEL TO ACCESS THE REAR OF THE GENERATOR.
 - HIGH VOLTAGE CONNECTION INCLUDING AC LOAD LEAD CONDUIT CONNECTION, NEUTRAL CONNECTION, AND BATTERY CHARGER (20 VOLT AC (0.5 AMP MAX) CONNECTION).
 - LOW VOLTAGE CONNECTION INCLUDING TRANSFER SWITCH CONTROL WIRES AND ACCESSORY RELAY CONNECTION (CITY POWER).
 - RECIRCULATION OF DISCHARGE AIR AND/OR IMPROPER COOLING AIR FLOW.
 - REFERENCE OWNERS MANUAL FOR LIFTING WARNINGS.
 - USE STANDARD SAFE TO LOOSE SPRESS.
 - MUST ALLOW FREE FLOW OF INTAKE AIR, DISCHARGE AIR AND EXHAUST. SEE SPEC SHEET FOR MINIMUM AIR FLOW AND MAXIMUM RESTRICTION REQUIREMENTS.
 - GENERATOR MUST BE INSTALLED SUCH THAT FRESH COOLING AIR IS AVAILABLE AND THAT DISCHARGE AIR FROM RADIATOR IS NOT RECIRCULATED.

WEIGHT DATA WITH EMPTY BASE TANK (SEE NOTE 5)

SERVICE ITEM	2.5L
OIL FILL CAP	RIGHT SIDE
OIL DIP STICK	RIGHT SIDE
OIL FILTER	RIGHT SIDE
OIL DRAIN HOSE	LEFT SIDE
RADIATOR DRAIN HOSE	LEFT SIDE
COOLANT RECOVERY BOTTLE	LEFT SIDE
RADIATOR FILL CAP ACCESS	ROOF
AIR CLEANER ELEMENT	LEFT SIDE
MUFFLER	FRONT
PAN BELT	ETHER SIDE
BATTERY	LEFT SIDE

REFERENCE OWNERS MANUAL FOR PERIODIC REPLACEMENT PART LISTINGS.

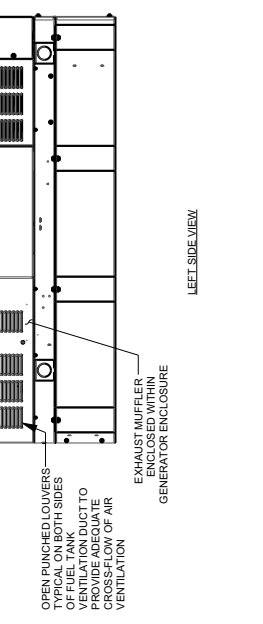
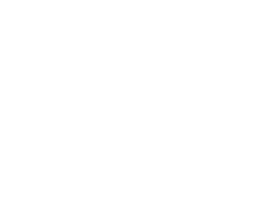
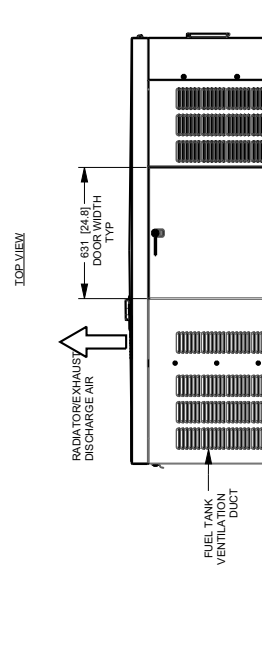
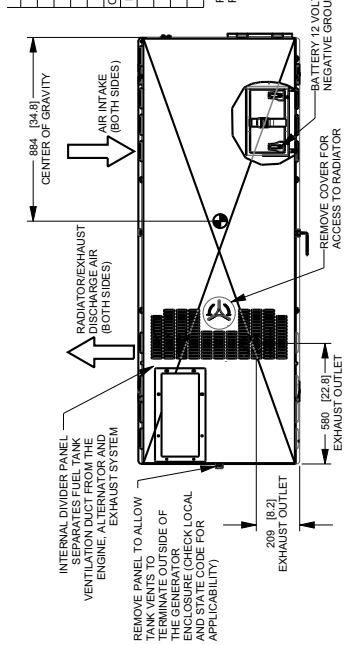
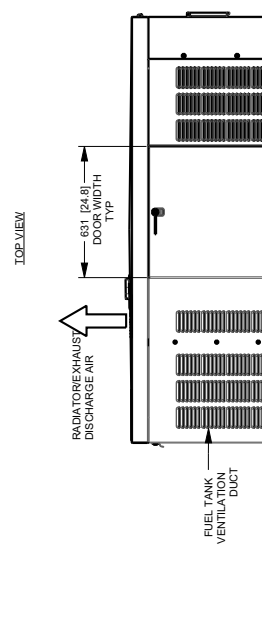
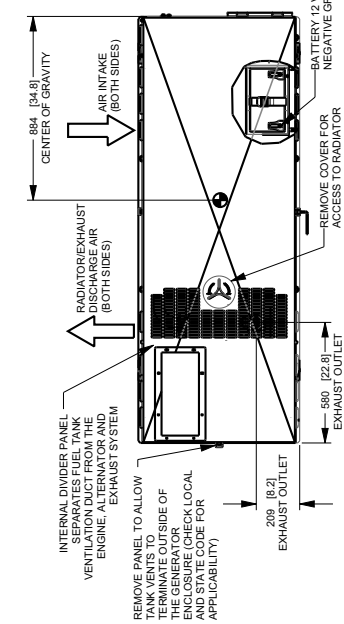

15 • 20 • 30 • 48 • 50 kW

D2.5L G2 32 Gal Tank (2 of 2)

FUEL TANK	
TOTAL CAPACITY	127 [33.5]
USABLE CAPACITY	121 [32]

CAPACITY: LITER (GALLON)
DIMENSIONS: MM (INCH)

TANK IS LISTED TO UL142 AND IJLC9601
NOTE: STUB-UP AREA FOR HIGH AND LOW VOLTAGE CONNECTIONS, CIRCUIT BREAKER, NEUTRAL AND CUSTOMER CONNECTION OPENING.

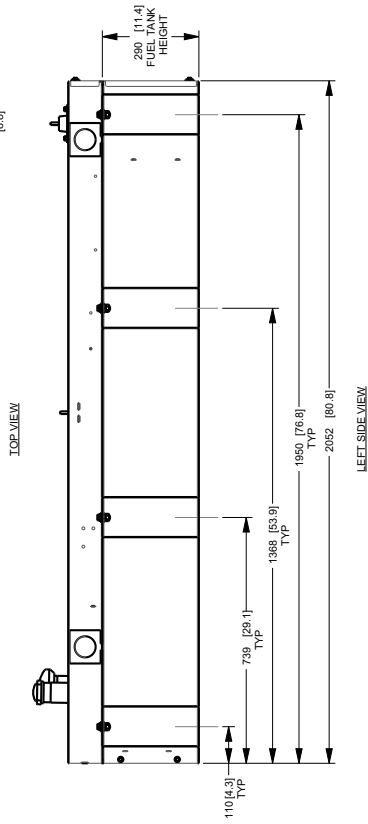
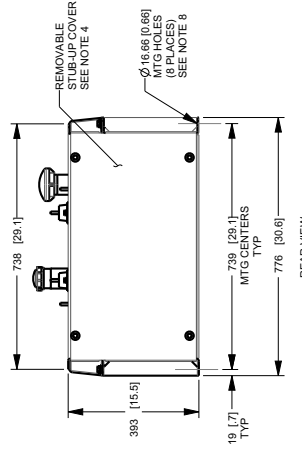
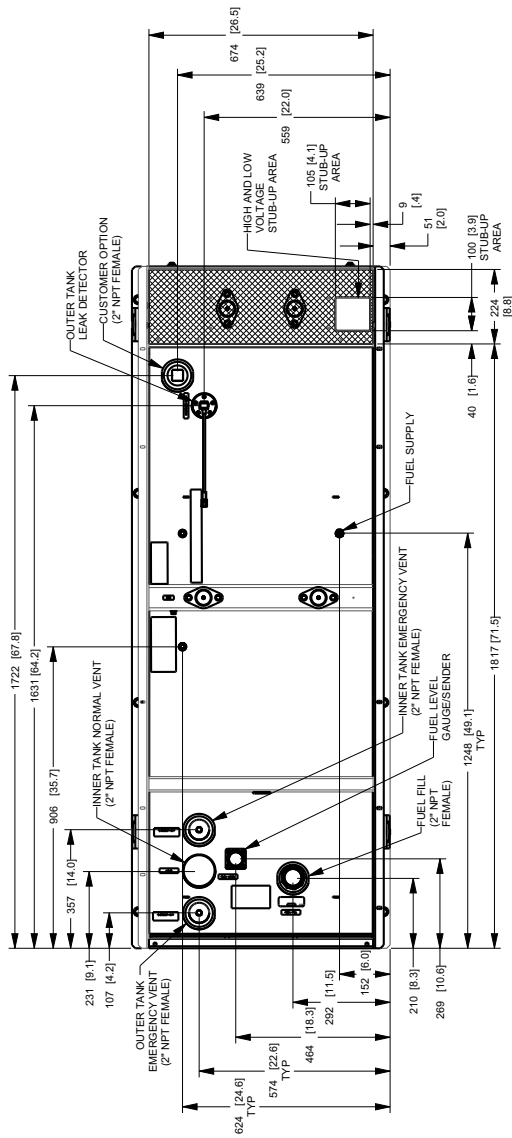

15 • 20 • 30 • 48 • 50 kW

D2.5L G2 95 Gal Tank (1 of 2)

Installation Drawings

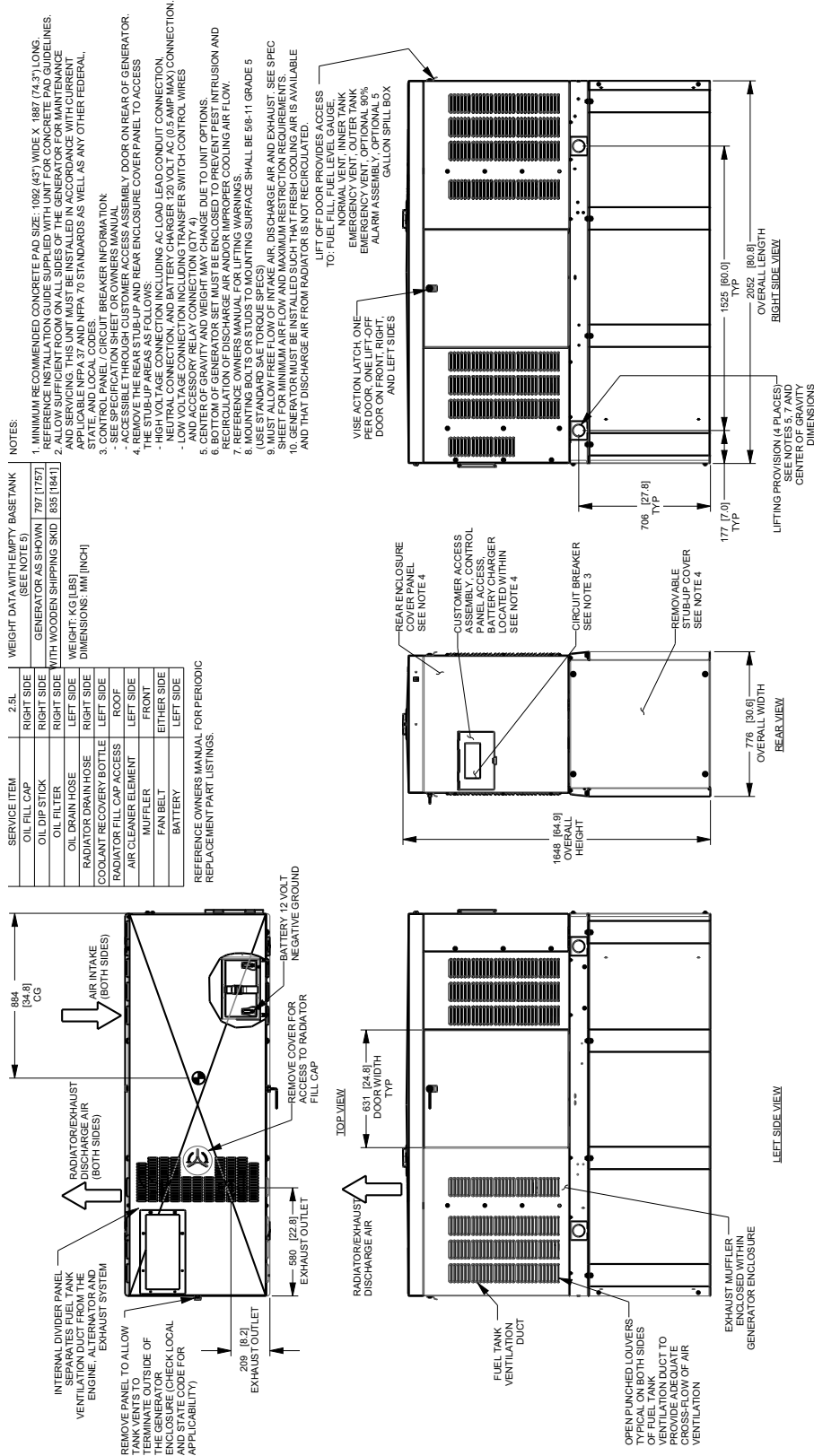

15 • 20 • 30 • 48 • 50 kW

D2.5L G2 95 Gal Tank (2 of 2)

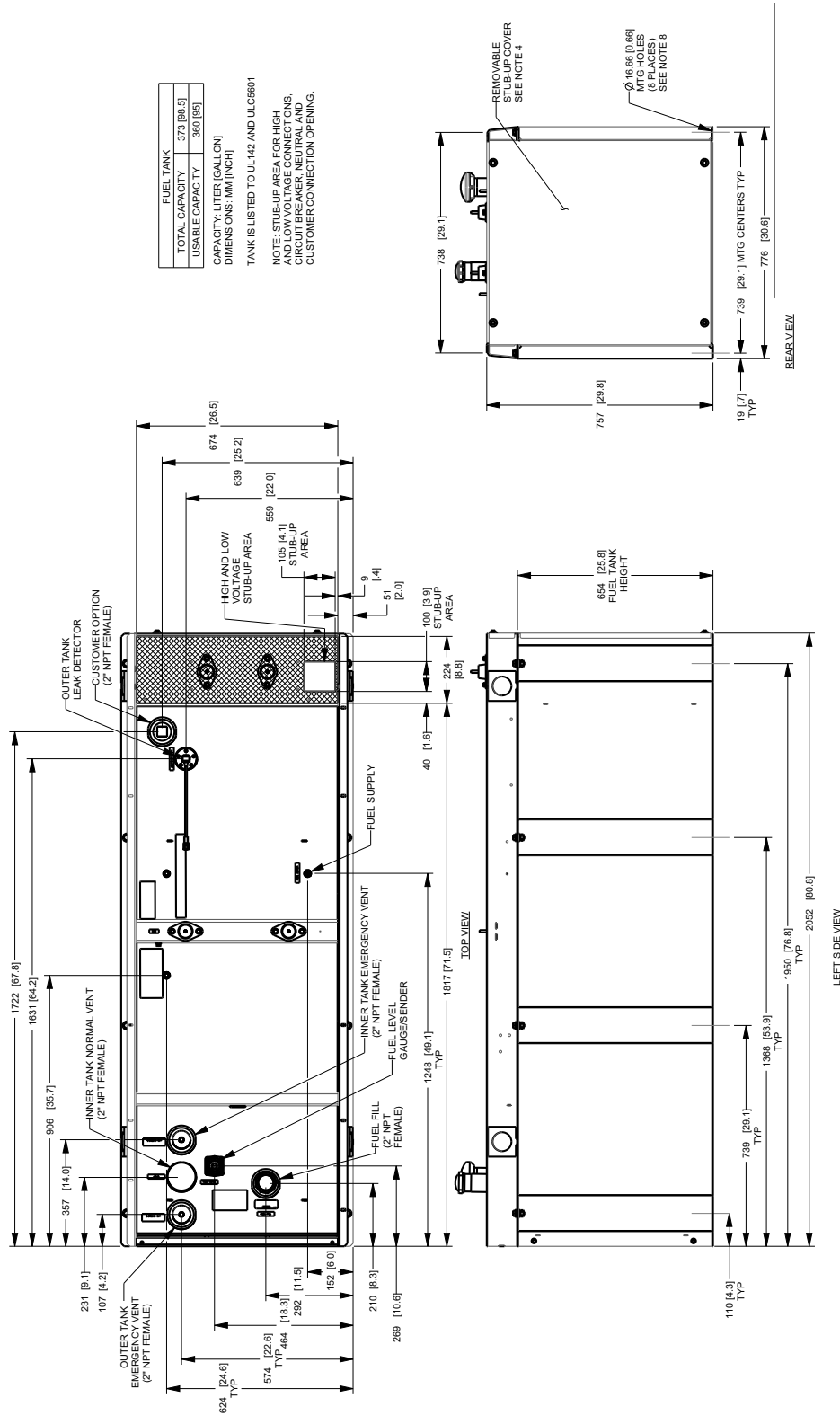

15 • 20 • 30 • 48 • 50 kW

D2.2L G22 57 Gal Tank (1 of 2)

SERVICE ITEM	2.2L
OIL FILL CAP	RIGHT SIDE
OIL DIP STICK	RIGHT SIDE
OIL FILTER	RIGHT SIDE
OIL DRAIN HOSE	RIGHT SIDE
RADIATOR DRAIN HOSE	LEFT SIDE
COOLANT RECOVERY BOTTLE	LEFT SIDE
RADIATOR FILL CAP ACCESS	ROOF
AIR CLEANER ELEMENT	RIGHT SIDE
MUFFLER	FRONT SIDE
FAN BELT	LEFT SIDE
BATTERY	LEFT SIDE

REFERENCE OWNERS MANUAL FOR PERIODIC REPLACEMENT PART LISTINGS

WEIGHT DATA WITH EMPTY BASE TANK (SEE NOTE 5)

GENERATOR AS SHOWN	842 (1857)
WITH WOODEN SHIPPING SKID	888 (1957)

W/ WEIGHT: KG (LBS)
DIMENSIONS: MM (INCH)

NOTES:

- MINIMUM RECOMMENDED CONCRETE PAD SIZE: 1184 (47") WIDE X 2261 (89") LONG. MINIMUM RECOMMENDED CONCRETE CURB HEIGHT: 100 (4") SUPPLIED WITH UNIT FOR CONCRETE PAD GUIDELINES.
- ALLOW SUFFICIENT ROOM ON ALL SIDES OF THE GENERATOR FOR MAINTENANCE AND SERVICING. THIS UNIT MUST BE INSTALLED IN ACCORDANCE WITH CURRENT NATIONAL ELECTRICAL CODE (NEC), NFPA 70 STANDARDS AS WELL AS ANY OTHER FEDERAL, STATE AND LOCAL CODES.
- CONTROL PANEL / CIRCUIT BREAKER INFORMATION:
- SEE SPECIFICATION SHEET OR OWNERS MANUAL
- ACCESSIBLE THROUGH CUSTOMER ACCESS ASSEMBLY DOOR ON REAR OF THE STUB-UP AREAS AS FOLLOWS:
- HIGH VOLTAGE CONNECTIONS INCLUDING AC LOAD LEAD CONDUIT CONNECTION AND RE-CIRCULATION OF DISCHARGE AIR AND/OR IMPROPER COOLING AIR FLOW.
- LOW VOLTAGE CONNECTIONS INCLUDING TRANSFER SWITCH CONTROL WIRES
- ENGINE SERVICE CONNECTIONS
- OIL DRAIN: 3/8" NPT
- AIR INTAKE: 7" O.D.
- BOTTOM OF GENERATOR SET MUST BE ENCLOSED TO PREVENT PEST INTRUSION AND AND RE-CIRCULATION OF DISCHARGE AIR AND/OR IMPROPER COOLING AIR FLOW.
8. REFERENCE OWNERS MANUAL FOR LIFTING WARNINGS
9. CONCRETE CURB OR CURB CONCRETE PAD SHALL BE 508-11 GRADE 5 (USE STANDARD SIZE TORQUE SPECS)

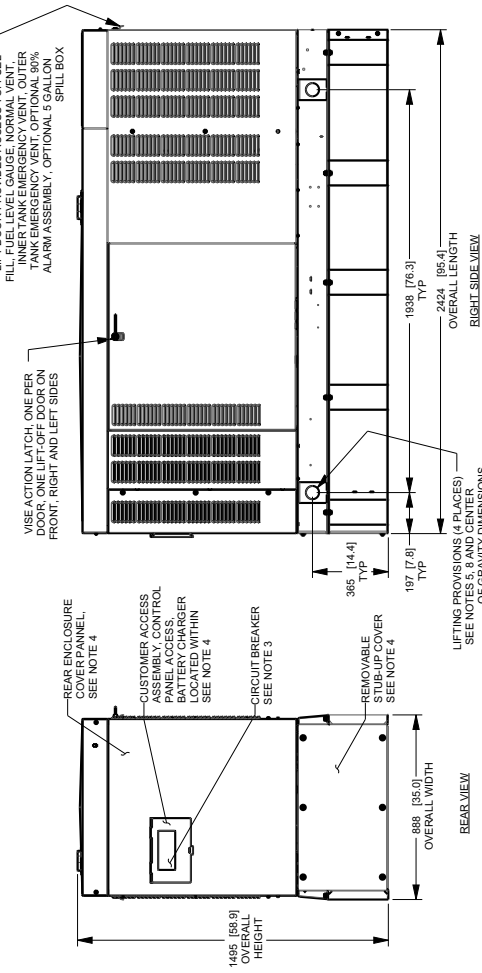
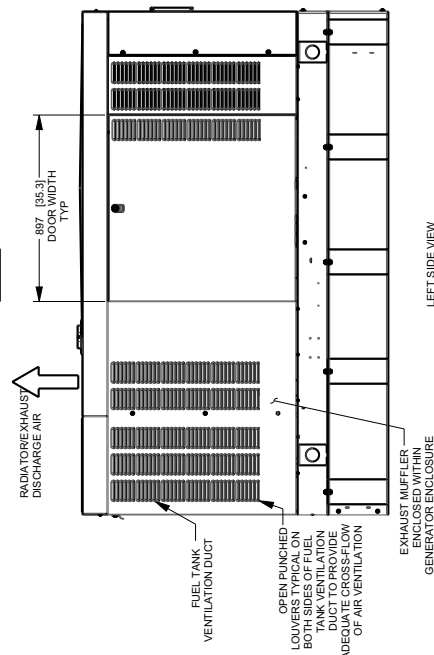
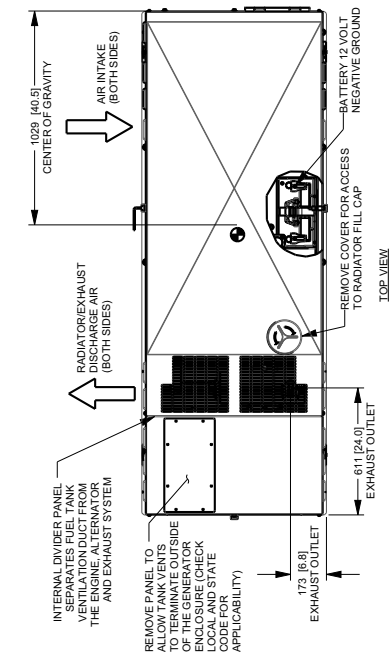

D2.2L G22 57 Gal Tank (2 of 2)

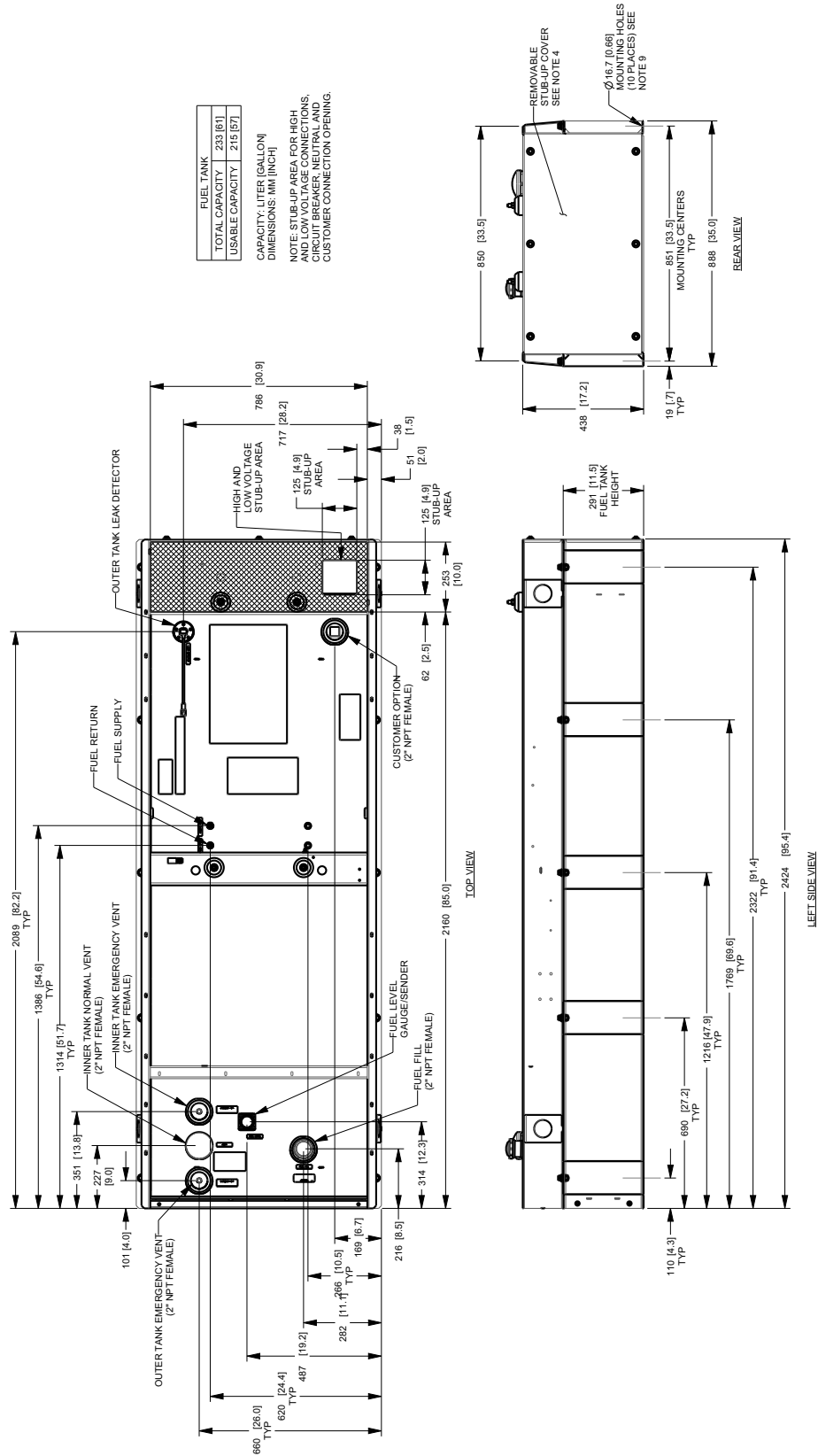

15 • 20 • 30 • 48 • 50 kW

Installation Drawings

D2.2L G22 132 Gal Tank (1 of 2)

SERVICE ITEM	2.2L
OIL FILL CAP	RIGHT SIDE
OIL DIP STICK	RIGHT SIDE
OIL FILTER	RIGHT SIDE
OIL DRAIN HOSE	RIGHT SIDE
RADIATOR DRAIN HOSE	LEFT SIDE
COOLANT RECOVERY BOTTLE	LEFT SIDE
RADIATOR FILL CAP ACCESS	ROOF
AIR CLEANER ELEMENT	RIGHT SIDE
FAN BELT	FRONT SIDE
BATTERY	LEFT SIDE

REFERENCE OWNERS MANUAL FOR PERIODIC REPLACEMENT PART LISTINGS

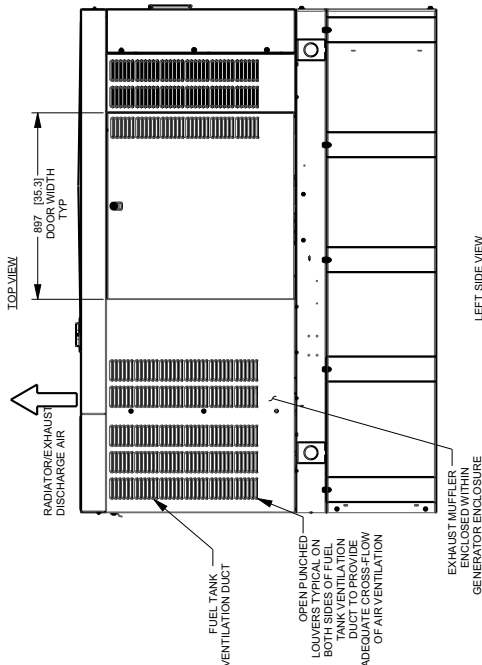
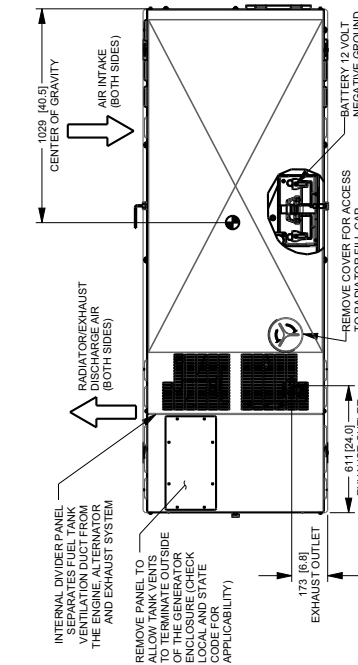

NOTES:

- MINIMUM RECOMMENDED CONCRETE PAD SIZE: 1194 (47") WIDE X 2261 (89") LONG. REFERENCE INSTALLATION GUIDE SUPPLIED WITH UNIT FOR CONCRETE PAD GUIDELINES.
- REMOVE THE REAR TANK AND REAR ENCLOSURE COVER PANEL TO ACCESS GENERATOR.
- SEE SPECIFICATION SHEET OR OWNERS MANUAL FOR ACCESSIBLE THROUGH CUSTOMER ACCESS ASSEMBLY DOOR ON REAR OF GENERATOR.
- REMOVE THE REAR TANK AND REAR ENCLOSURE COVER PANEL TO ACCESS GENERATOR.
- HIGH VOLTAGE CONNECTION INCLUDING AC LOAD LEAD CONDUIT CONNECTION NEUTRAL CONNECTION, BATTERY CHARGER 120 VOLT AC (0.5 AMP MAX) CONNECTION.
- LOW VOLTAGE CONNECTIONS INCLUDING TRANSFER SWITCH CONTROL WIRES.
- ENGINE SERVICE CONNECTIONS.
- OIL DRAIN: 3/8" NPT.
- EXHAUST OUTLET: 2" O.D.
- BOTTOM OF GENERATOR SET MUST BE ENCLOSED TO PREVENT PEST INTRUSION AND TO PROVIDE PROTECTION FROM WEATHER AND TO IMPROVE COOLING AIR FLOW.
- REFERENCE OWNERS MANUAL FOR LIFTING WARNINGS.
- Mounting bolts or studs to concrete pad shall be 5/8-11 GRADE 5 (USE STANDARD SAE TORQUE SPECS)

WEIGHT DATA WITH EMPTY BASE/TANK (SEE NOTE 5)

GENERATOR AS SHOWN	939 [207.0]
WITH WOODEN SHIPPING SKID	965 [217.2]
WEIGHT, KG (LBS)	
DIMENSIONS, MM (INCH)	

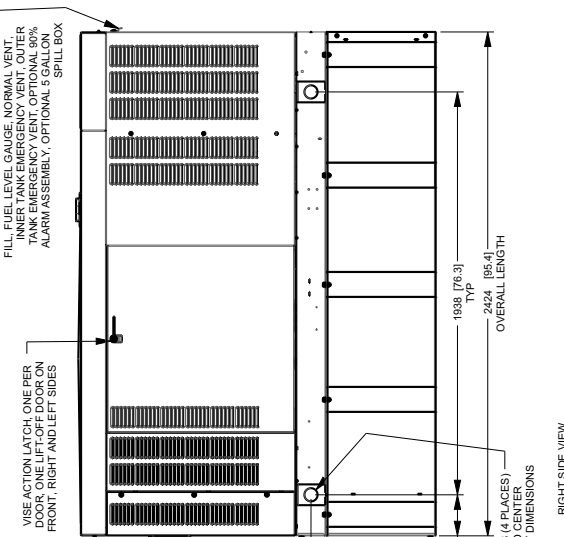

RIGHT SIDE VIEW

LIFTING PROVISIONS (4 PLACES) SEE NOTES 5, 8 AND CENTER OF GRAVITY DIMENSIONS

15 • 20 • 30 • 48 • 50 kW

D2.2L G22 132 Gal Tank (2 of 2)

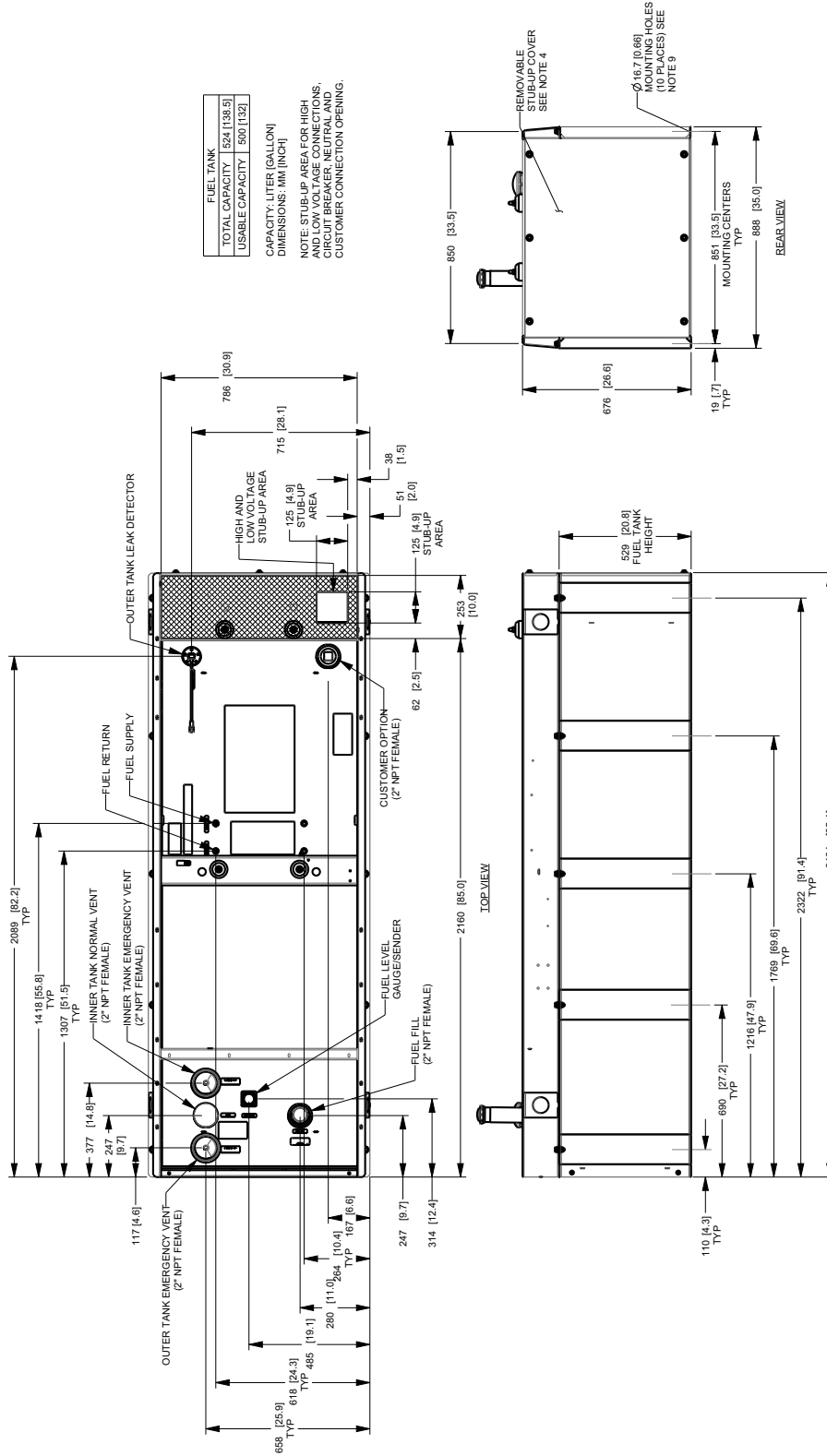

15 • 20 • 30 • 48 • 50 kW

D3.3L 57 Gal Tank (1 of 2)

Installation Drawings

SERVICE ITEM	3.3L	WEIGHT DATA WITH EMPTY BASE/TANK (SEE NOTE 5)	NOTES:
OIL FILL CAP	LEFT	GENERATOR AS SHOWN 1005 [215]	1. MINIMUM RECOMMENDED CONCRETE PAD SIZE: 1194 (47") WIDE X 2718 (107") LONG. REFERENCE INSTALLATION GUIDE SUPPLIED WITH UNIT
OIL DIP STICK	LEFT	WITH WOODEN SHIPPING SKID 1030 [235]	2. ALLOW SUFFICIENT ROOM ON ALL SIDES OF THE GENERATOR FOR MAINTENANCE AND SERVICING. THIS UNIT MUST BE INSTALLED IN ACCORDANCE WITH CURRENT APPLICABLE NFPA 37 AND NFPA 70 STANDARDS AS WELL AS ANY OTHER FEDERAL, STATE, AND LOCAL CODES.
OIL DRAIN HOSE	RIGHT	WEIGHT: KG (LBS)	3. SEE SPECIFICATION SHEET OR OWNERS MANUAL FOR BREAKER INFORMATION.
RADIATOR DRAIN HOSE	RIGHT	DIMENSIONS: MM (INCH)	- ACCESSIBLE THROUGH CUSTOMER ACCESS ASSEMBLY DOOR ON REAR OF GENERATOR
COOLANT RECOVERY BOTTLE	RIGHT		4. REMOVE THE REAR TANK AND REAR ENCLOSURE COVER PANEL TO ACCESS GENERATOR
RADIATOR FILL CAP ACCESS	ROOF		5. HIGH VOLTAGE CONNECTION INCLUDING AC LOAD LEAD CONDUIT CONNECTION NEUTRAL CONNECTION, BATTERY CHARGER 120 VOLT AC (0.5 AMP MAX) CONNECTION.
AIR CLEANER ELEMENT	FRONT		- LOW VOLTAGE CONNECTIONS INCLUDING TRANSFER SWITCH CONTROL WIRES
MUFFLER	FRONT		5. CENTER OF GRAVITY AND WEIGHT MAY CHANGE DUE TO UNIT OPTIONS.
FAN BELT	EITHER		6. BATTERY POSITIVE CONNECTIONS
BATTERY	RIGHT		6. BATTERY POSITIVE CONNECTIONS

REFERENCE OWNERS MANUAL FOR PERIODIC REPLACEMENT PART LISTINGS

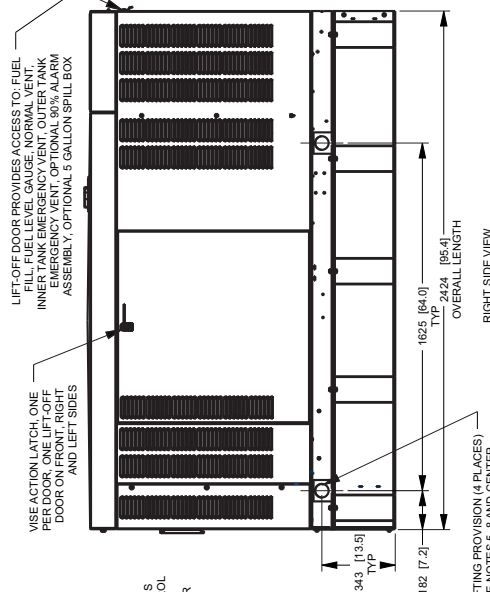
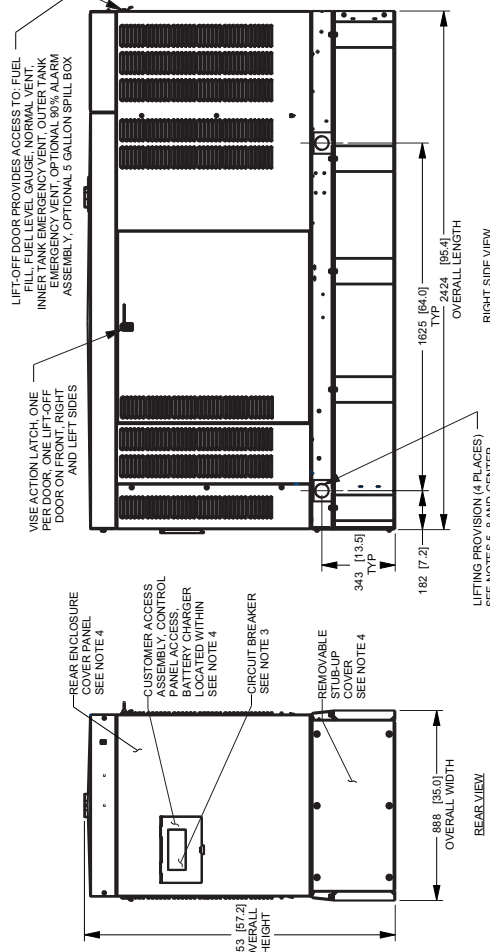
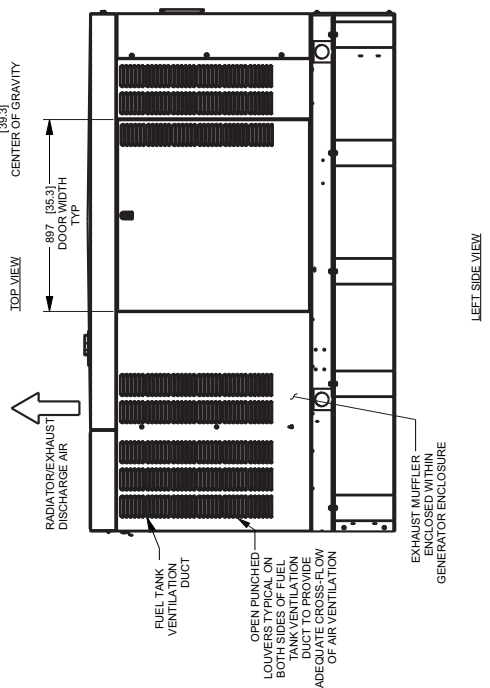
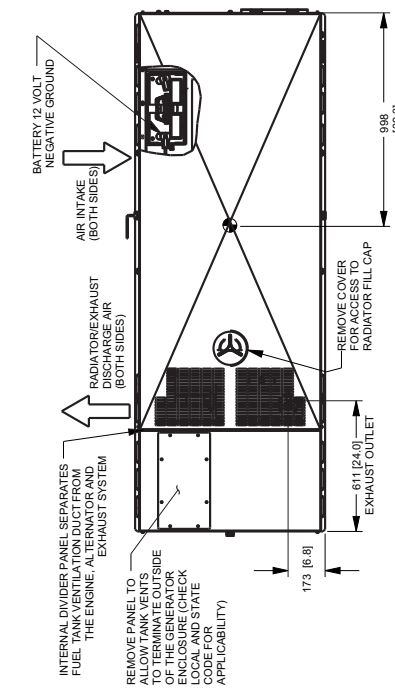

15 • 20 • 30 • 48 • 50 kW

D3.3L 57 Gal Tank (2 of 2)

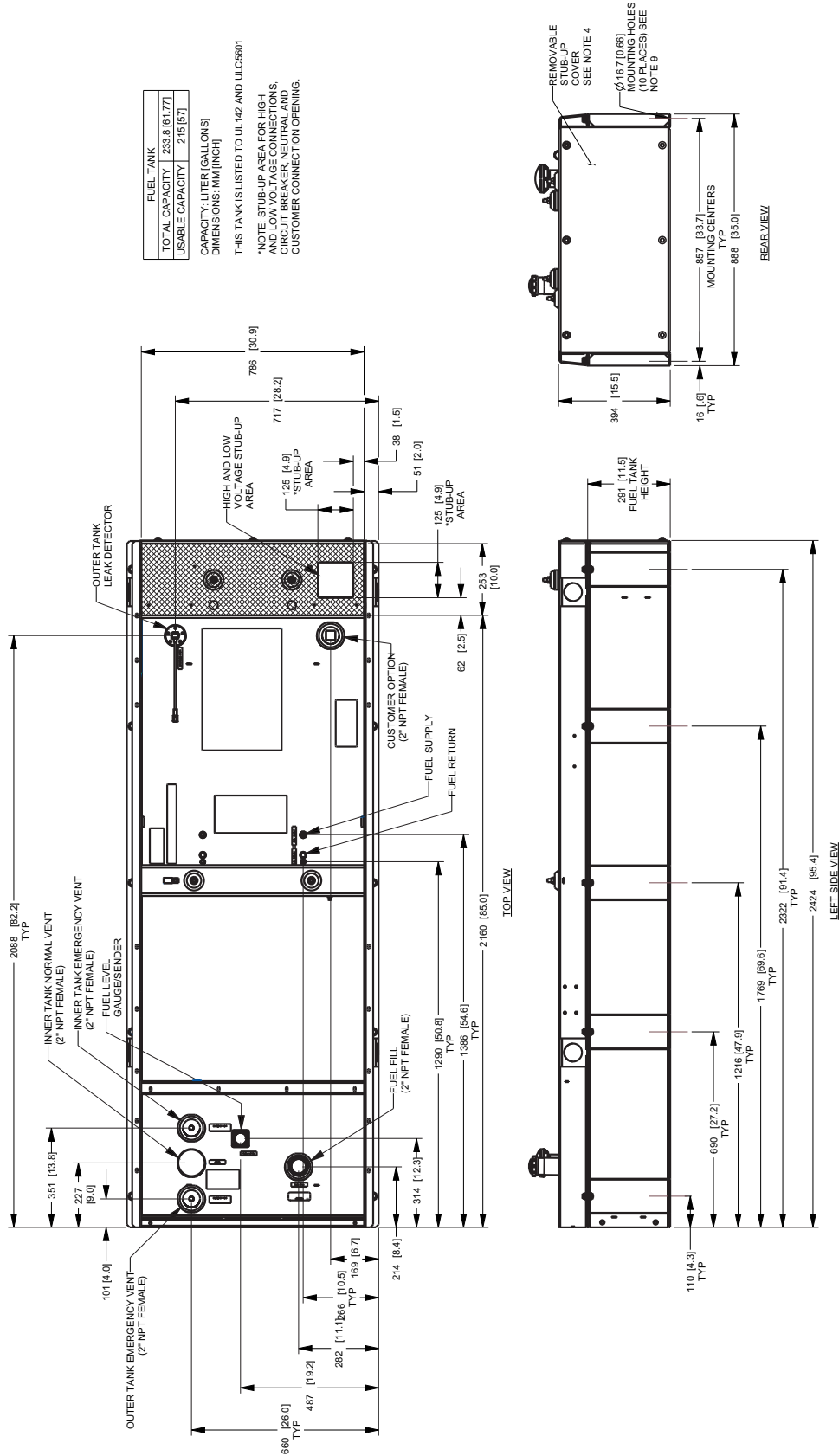

15 • 20 • 30 • 48 • 50 kW

D3.3L G16 132 Gal Tank (1 of 2)

NOTES:

- MINIMUM RECOMMENDED CONCRETE PAD SIZE: 1184 (47") WIDE X 2718 (107") LONG. REFERENCE INSTALLATION GUIDE SUPPLIED WITH UNIT.
- ALLOW SUFFICIENT ROOM ON ALL SIDES OF THE GENERATOR FOR MAINTENANCE AND SERVICING. THIS UNIT MUST BE INSTALLED IN ACCORDANCE WITH CURRENT APPLICABLE NFPA 37 AND NFPA 70 STANDARDS AS WELL AS ANY OTHER FEDERAL, STATE OR LOCAL APPLICABLE CODES.
- CONTROL PANEL, CIRCUIT BREAKER INFORMATION:
 - SEE SPECIFICATION SHEET OR OWNERS MANUAL.
 - ACCESSIBLE THROUGH CUSTOMER ACCESS ASSEMBLY DOOR ON REAR OF GENERATOR.
 - REAR TANK AND REAR ENCLOSURE COVER PANEL TO ACCESS THE STUB-UP AREAS AS FOLLOWS:
 - HIGH VOLTAGE CONNECTION INCLUDING AC LOAD LEAD CONDUIT CONNECTION
 - NEUTRAL CONNECTION, BATTERY CHARGER 120 VOLT AC (0.5 AMP MAX) CONNECTION.
 - LOW VOLTAGE CONNECTIONS INCLUDING TRANSFER SWITCH CONTROL WIRES
 - ENGINE SERVICE CONNECTIONS
- GENERATOR EXHAUST OUTLET: 2" O.D.
- BOTTOM OF GENERATOR SET MUST BE ENCLOSED TO PREVENT PEST INTRUSION AND AIR CURTAINING. SEE INSTALLATION GUIDE FOR UPPER COOLING AIR FLOW.
- REFERENCE OWNERS MANUAL FOR MOUNTING DIMENSIONS.
- MOUNTING BOLTS OR STUDS TO CONCRETE PAD SHALL BE 5/8-11 GRADE 5 (USE STANDARD SAE TORQUE SPECS)
- LIFT-OFF DOOR PROVIDES ACCESS TO: FUEL FILL, FUEL LEVEL GAUGE, NORMAL VENT, INNER TANK EMERGENCY VENT, OUTER TANK EMERGENCY VENT, BATTERY CHARGER ASSEMBLY, OPTIONAL 5 GALLON SPILL BOX

SERVICE ITEM	D3.3L	WEIGHT DATA WITH EMPTY BASE TANK (SEE NOTE 5)
OIL FILL CAP	LEFT	GENERATOR AS SHOWN 102 [24.29]
OIL DIP STICK	LEFT	WITH WOODEN SHIPPING SKID 147 [25.29]
OIL FILTER	LEFT	
OIL DRAIN HOSE	RIGHT	
RADIATOR DRAIN HOSE	RIGHT	WEIGHT: KG (LBS)
COOLANT RECOVERY BOTTLE	RIGHT	DIMENSIONS: MM (INCH)
RADIATOR FILL CAP ACCESS	ROOF	
AIR CLEANER ELEMENT	RIGHT	
MUFFLER	FRONT	
PAN BELT	EITHER	
BATTERY	RIGHT	

REFERENCE OWNERS MANUAL FOR PERIODIC REPLACEMENT PART LISTINGS

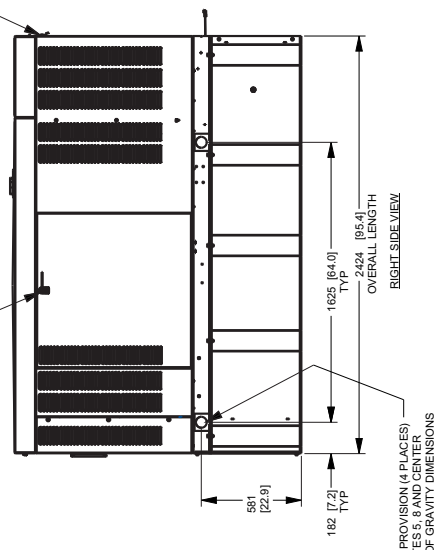
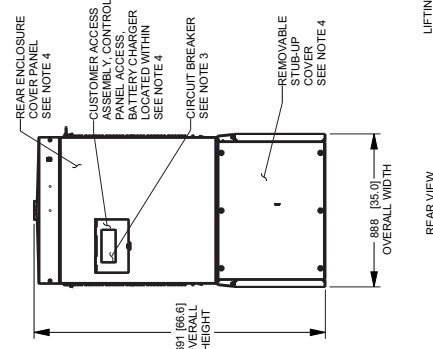
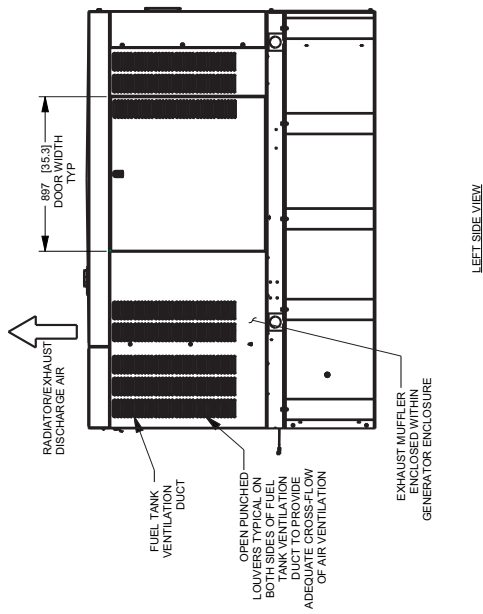
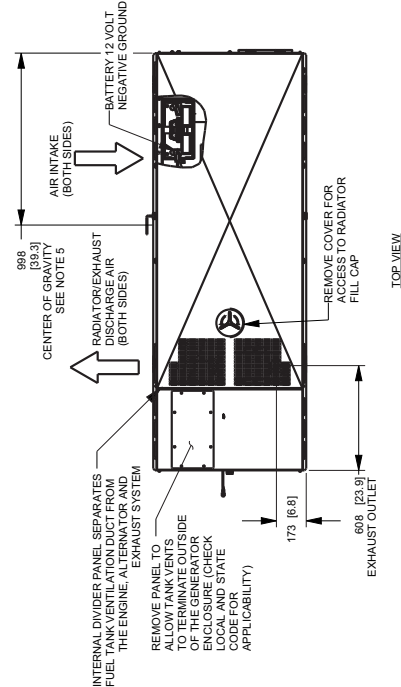

D3.3L G16 132 Gal Tank (2 of 2)

FUEL TANK	
TOTAL CAPACITY	624 [138.5]
USABLE CAPACITY	500 [132]

CAPACITY: LITER (GALLONS)
DIMENSIONS: MM (INCH)

THIS TANK IS LISTED TO UL 142 AND ULCS601

*NOTE: STUB-UP AREA FOR HIGH AND LOW VOLTAGE CONNECTIONS, CIRCUIT BREAKER, NEUTRAL AND CUSTOMER CONNECTION OPENING.

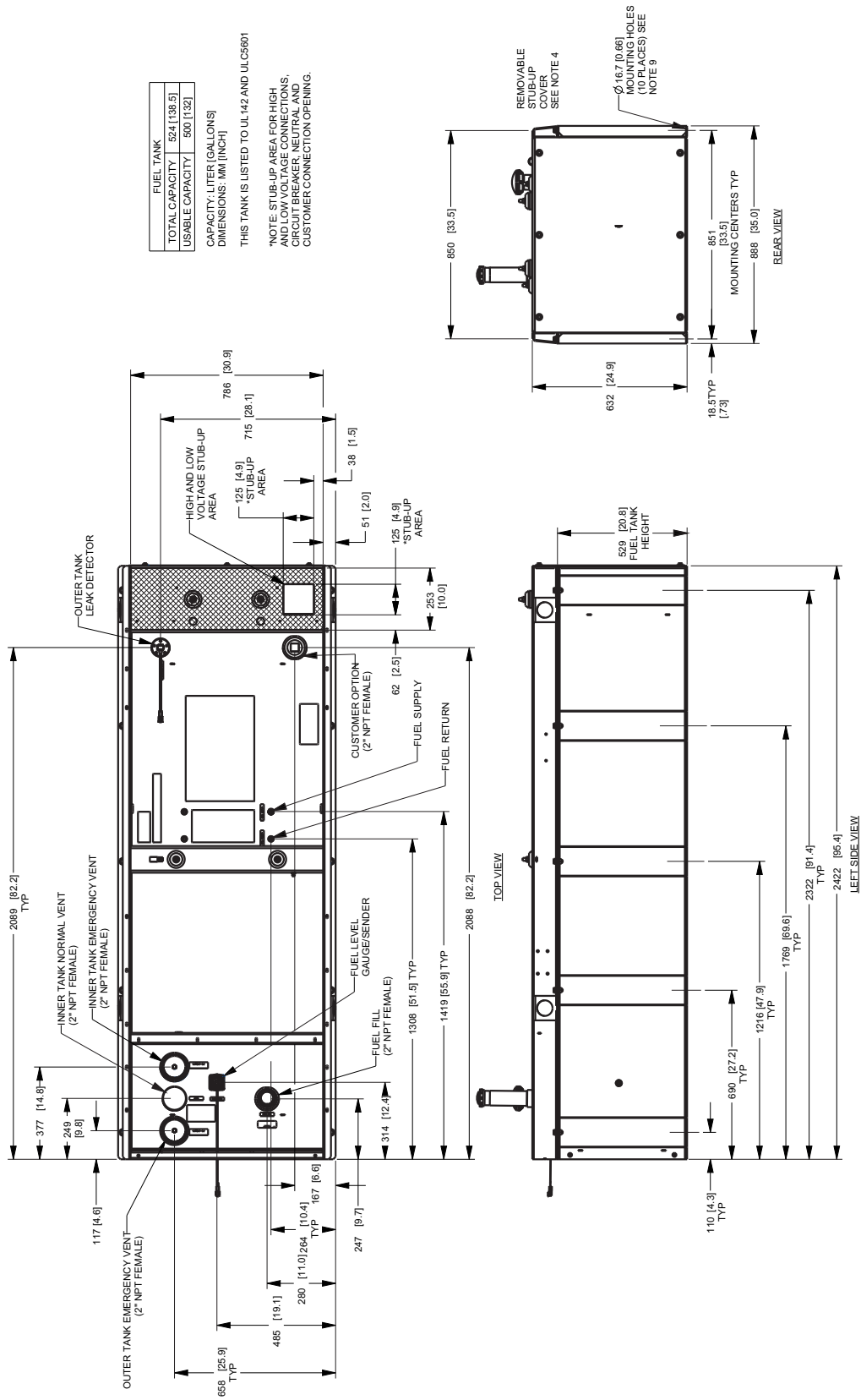

15 • 20 • 30 • 48 • 50 kW

GENERAC®**Available Accessories**

Model #	Product	Description
G006478-0	Harness Adapter Kit	The Harness Adapter Kit is required to make liquid-cooled units compatible with Mobile Link™.
G006502-0	Spill Box	The 5-gallon spill box screws into the existing fuel fill port of the base tank. It captures and contains fuel if over fueling or spilling occurs during the fill process.
G006504-0	90% Fuel Level Alarm	The 90% fuel level alarm alerts the fuel fill operator when the tank reaches a 90% fill level by sounding an audible alarm and triggering an LED warning light.
G006505-0—15 & 20 kW G006506-0—30, 48, & 50 kW	Tank Risers	Tank risers are required in some municipalities to help avoid potential base tank corrosion caused by mounting on rough surfaces.
G006507-0	Fuel Fill Drop Tube	A powder coat painted, steel fuel fill drop tube is required in some municipalities to prevent sparking due to static electricity buildup, which can be caused by the fuel dropping into the tank from the fill area. Using a drop tube also results in submerged filling, which increases the fuel delivery flow rate and reduces vapors, foam and potential tank evaporation.
G007660-0—15 & 20 kW G007661-0—30 kW G007662-0—48 & 50 kW	Stainless Steel Fuel Lines	Some municipalities require the use of stainless steel fuel lines instead of the standard hoses provided with the diesel generator products. These stainless steel lines are fire resistant for additional safety.
G006510-0	E-Stop	E-stop allows for immediate fuel shutoff and generator shutdown in the event of an emergency.
G006511-0	Spill Box Drainback Kit	The spill box drainback kit allows fuel that was captured in the 5-gallon spill box to be drained directly back into the fuel tank to avoid vapors.
G006588-1	Vent Extension Support Kit	The vent extension support kit consists of two aluminum plates with the appropriate pipe cutouts to secure the vent extension pipes coming through the top of the generator enclosure. It helps to minimize stress on the NPT fittings integrated on the tank and also helps protect against pests.
G006512-0	Lockable Fuel Cap	The cast iron, lockable fuel cap provides the ability to lock the fuel system to prevent unwanted fuel tampering or fuel siphoning.
G007640-0—15 & 20 kW G007641-0—30 kW G007642-0—48 & 50 kW	Maintenance Kits	The Protector Maintenance Kits offer all the hardware necessary to perform complete maintenance on Generac Protector generators.
G007650-0—15 & 20 kW G007651-0—30 kW G007652-0—48 & 50 kW	Cold Weather Kits	Recommended for generators installed in regions where the temperature regularly falls below 32 °F (0 °C). The Cold Weather Kits consist of a block heater with all necessary mounting hardware and a battery warmer with a thermostat built into the battery wrap.
G005703-0	Paint Kit	If the generator enclosure is scratched or damaged, it is important to touch up the paint to protect from future corrosion. The paint kit includes the necessary paint to properly maintain or touch up a generator enclosure.
G006873-0	Smart Management Module (50 Amps)	Manage large loads by utilizing up to 8 individual Smart Management modules. These devices are installed directly in line with existing appliance wiring for easy installation.
A0000018981	Ultrasonic Cleaner Solution	An ultra-concentrated anti-corrosive cleaning solution engineered to reach the smallest cavities to clean the toughest contaminants. This water based formula is non-toxic, biodegradable, safe for both metal and plastic surfaces and is superior in rinsability.
A0000019001	All Surface Protectant	All surface protectant for vinyl, rubber, plastics creates a barrier that seals & protects surfaces from water, UV rays while renewing the look of the surface.

GENERAC®

Generac Power Systems, Inc. • S45 W29290 HWY. 59, Waukesha, WI 53189 • generac.com

©2018 Generac Power Systems, Inc. All rights reserved. All specifications are subject to change without notice. Part No. 10000023912-E 04/16/2020